

DBu

Digital Belt Pack Transmitter

DBu, DBu/E01



Fill in for your records:

Serial Number:

Purchase Date:



Table of Contents

Introduction	2
Frequency Agility.....	2
Encryption.....	2
Servo Bias Input and Wiring	3
DSP-controlled Input Limiter.....	3
DBu, DBu/E01 Block Diagram	3
Battery Installation	4
Battery Status LED Indicator	4
Belt Clips.....	5
IR (infrared) Port	5
Features and Functions	5
Operating Instructions	6
Powering On in Operating Mode.....	6
Powering On in Standby Mode	6
Powering Off	6
Power Menu Options	6
Entering the Power Menu.....	6
LCD Menu Map	7
Main Menu and Setup Screen Details	8
Entering the Main Menu.....	8
Main Window Indicators	8
Connecting the Signal Source	8
Adjusting the Input Gain.....	8
Selecting Frequency	9
Selecting Programmable Switch Functions.....	9
Selecting the Low Frequency Roll-off	9
Selecting Audio Polarity (Phase).....	9
Selecting Battery Type	9
Setting Transmitter Output Power	9
Remote	9
Locking/Unlocking Changes to Settings.....	10
Restoring Default Settings	10
KeyType	10
WipeKey.....	10
SendKey.....	10
LectroRM	11
Whip Antennas	12
Encryption Key and Settings Transfer	12
Accessories	13
5-Pin Input Jack Wiring	14
Microphone Cable Termination for Non-Lectrosonics Microphones	15
Input Jack Wiring for Different Sources	16
Microphone RF Bypassing.....	17
Line Level Signals.....	17
Wireless Designer Software	18
Firmware Update Instructions	18
Specifications	19
Troubleshooting	20
Service and Repair	21
Returning Units for Repair	21

Introduction

The DBu, DBu/E01 transmitter employs high efficiency digital circuitry for extended operating time on two AA batteries. The transmitter can tune in coarse or fine steps across the UHF television band from 470.100 to 607.950 MHz (DBu/E01 frequency range is 470.100 to 614.375 MHz), with a selectable output power of 25 or 50 mW. The pure digital architecture enables AES 256-CTR encryption for high level security applications.

Studio quality audio performance is assured by high quality components in the preamp, wide range input gain adjustment and DSP-controlled limiting. Input connections and settings are included for any lavalier microphone, dynamic microphones and line level inputs. Input gain is adjustable over a 44 dB range in 1 dB steps to allow an exact match to the input signal level, to maximize the dynamic range and signal to noise ratio.

Frequency Agility

The transmitter tunes across the entire frequency range, from 470.100 MHz to 607.950 MHz (DBu/E01 frequency range is 470.100 to 614.375 MHz).

Encryption

When transmitting audio, there are situations where privacy is essential, such as during professional sporting events, in court rooms or private meetings. For instances where your audio transmission needs to be kept secure, without sacrificing audio quality, Lectrosonics introduces Encryption Keys. Truly entropic encryption keys are first created by a Lectrosonics receiver, such as the DSQD Receiver. The key is then synced with the DBu, DBu/E01 via the IR port. The audio will be encrypted and can only be listened to if both DBu, DBu/E01 and receiver have the matching encryption key. If you are trying to transmit an audio signal and keys do not match, all that will be heard is silence or white noise.

Servo Bias Input and Wiring

The DBu, DBu/E01 input preamp is a unique design that delivers audible improvements over conventional transmitter inputs, is easier to use and much harder to overload. It is not necessary to introduce pads on some mics to prevent overload of the input stage, divide the bias voltage down for some low voltage mics, or reduce the limiter range at minimum gain settings.

Two different microphone wiring schemes are available to simplify and standardize the configuration. Simplified 2-wire and 3-wire configurations provide several arrangements designed for use only with servo bias inputs to take full advantage of the preamp circuitry. Other wiring schemes are compatible with Servo Bias and conventional inputs.

A line level input wiring provides an extended frequency response with an LF roll-off at 35 Hz for use with instruments and line level signal sources.

DSP-controlled Input Limiter

The transmitter employs a digitally-controlled analog audio limiter prior to the analog-to-digital converter. The limiter has a range greater than 30 dB for excellent overload protection. A dual release envelope makes the limiter acoustically transparent while maintaining low distortion. It can be thought of as two limiters in series, connected as a fast attack and release limiter followed by a slow attack and release limiter. The limiter recovers quickly from brief transients, so that its action is hidden from the listener, but recovers slowly from sustained high levels to keep audio distortion low and preserve short term dynamic changes in the audio.

DBu, DBu/E01 Block Diagram

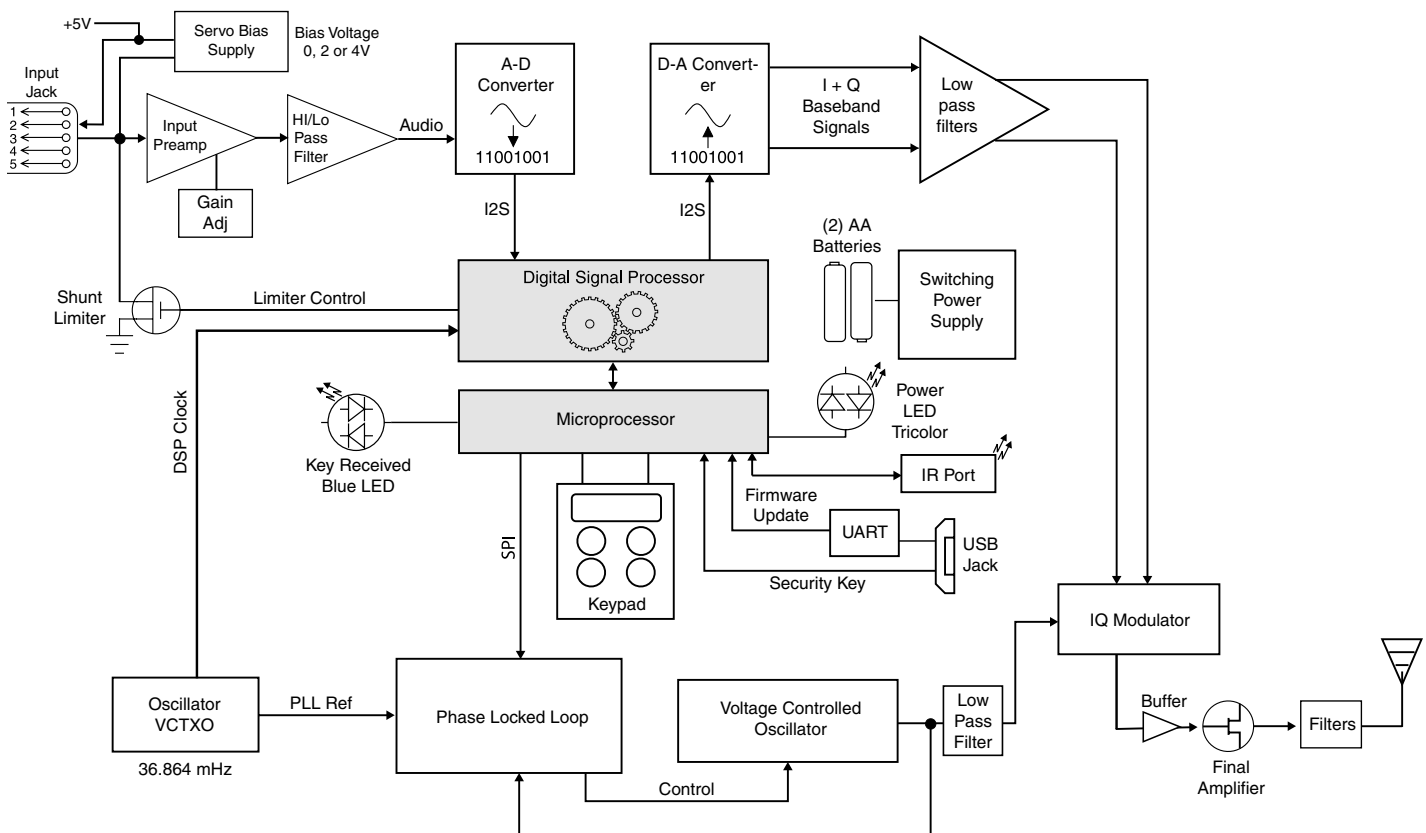

Consumer Alert for US Users - FCC Order DA 10-92

Most users do not need a license to operate this wireless microphone system. Nevertheless, operating this microphone system without a license is subject to certain restrictions: the system may not cause harmful interference; it must operate at a low power level (not in excess of 50 milliwatts); and it has no protection from interference received from any other device. Purchasers should also be aware that the FCC is currently evaluating use of wireless microphone systems, and these rules are subject to change. For more information, call the FCC at 1-888- CALL-FCC (TTY: 1-888-TELL-FCC) or visit the FCC's wireless microphone website at www.fcc.gov/cgb/wirelessmicrophones. To operate wireless microphone systems at power greater than 50mW, you must qualify as a Part 74 user and be licensed. If you qualify and wish to apply for a license go to: <http://www.fcc.gov/Forms/Form601/601.html>

Battery Installation

The transmitter is powered by two AA batteries. We recommend using alkaline, lithium, or rechargeable batteries for longest life.

The battery status circuitry compensates for the difference in voltage drop between alkaline and lithium batteries across their usable life, so it's important to select the correct battery type in the menu.

Because rechargeable batteries run down quite abruptly, using the Power LED to verify battery status will not be reliable. However, it is possible to track battery status using the battery timer function available in the receiver.

Push outward on the battery compartment door and lift it to open.

Slide door out to release catch



Lift door to open



Insert the batteries according to the markings on the back of the housing.

If the batteries are inserted incorrectly, the door will close but the unit will not operate.

The battery contacts can be cleaned with alcohol and a cotton swab, or a clean pencil eraser. Be sure not to leave any remnants of the cotton swab or eraser crumbs inside the compartment.

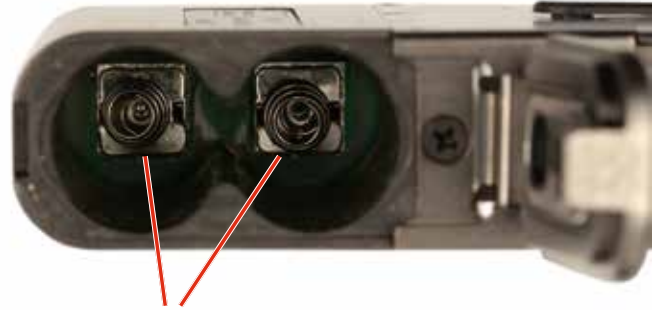

Contact springs

Battery Status LED Indicator

Alkaline, lithium or rechargeable batteries can be used to power the transmitter. The type of batteries in use are selectable in a menu on the LCD.

When alkaline or lithium batteries are being used, the LED labeled BATT on the keypad glows green when the batteries are good. The color changes to red when they are nearing the end of life. When the LED begins to *blink* red, there will be only a few minutes remaining.

The Power/Function LED on the top panel will mirror the keypad LED unless the programmable switch is set to Mute, and the switch is turned on.

The exact point at which the LEDs turn red will vary with battery brand and condition, temperature and power consumption. The LEDs are intended to simply catch your attention, not to be an exact indicator of remaining time.

A weak battery will sometimes cause the Power LED to glow green immediately after the transmitter is turned on, but it will soon discharge to the point where it will turn red or the unit will turn off completely.

Rechargeable batteries give little or no warning when they are depleted. If you wish to use these batteries in the transmitter, the most accurate way to determine runtime status is by testing the time provided by a particular battery brand and type, then using the **BatTime** function to determine remaining runtime.

NOTE: Refer to the Main Menu and Setup Section for BatTime details.

Features and Functions

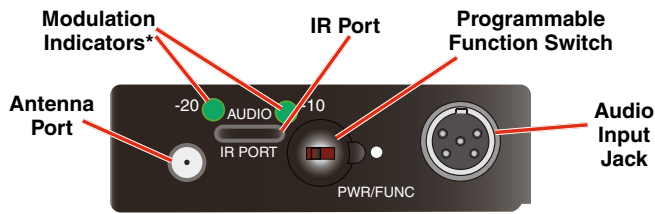

Full access to all settings is provided through the keypad and LCD. The transmitter can also be configured as a “one button” device by locking the ability to make changes with the keypad, and configuring the top panel switch as either power on/off or a mute function.

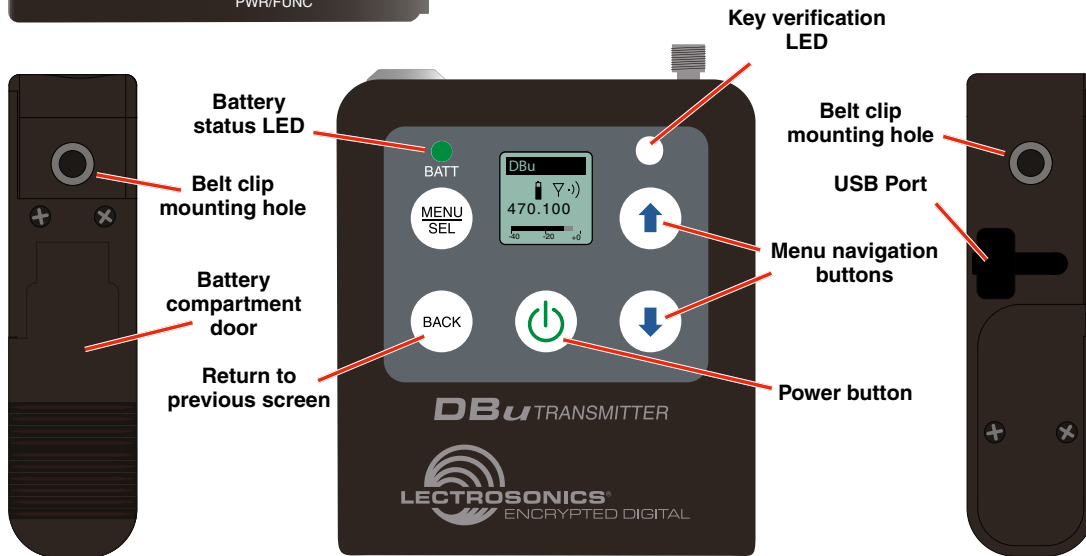

*When the transmitter is set to MUTE, the -10 Modulation Indicators LED will glow solid red. Otherwise, the -10 Modulation Indicators LED will glow solid green when transmitter is on.



Belt Clips

The wire belt clip may be removed by pulling the ends out of the holes in the sides of the case. Be sure to have a firm grip to avoid scratching the surface of the housing.

An optional spring-loaded, hinged belt clip (model number BCSLEBN) is also available. This clip is attached by removing the plastic hole cap on the back of the housing and mounting the clip with the supplied screw.

IR (infrared) Port

The IR port is available on the top of the transmitter for quick setup using a receiver with this function available. IR Sync will transfer the settings for frequency from the receiver to the transmitter.

Operating Instructions

Powering On in Operating Mode

Press and hold the Power Button until a status bar on the LCD is completed.



When you release the button, the unit will be operational with the RF output turned on and the Main Window displayed.

Powering On in Standby Mode

A brief press of the Power Button, and releasing it before status bar has completed, will turn the unit on with the RF output turned off. In this Standby Mode the menus can be browsed to make settings and adjustments without the risk of interfering with other wireless systems nearby.

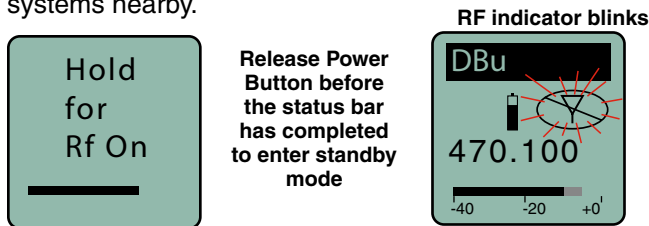

After settings and adjustments are made, press the power button again to turn the unit off.

Powering Off

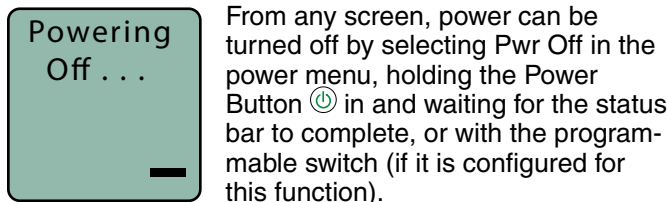

From any screen, power can be turned off by selecting Pwr Off in the power menu, holding the Power Button in and waiting for the status bar to complete, or with the programmable switch (if it is configured for this function).

If the power button is released, or the top panel switch is turned back on again before the status bar is completed, the unit will remain turned on and the LCD will return to the same screen or menu that was displayed previously.

NOTE: If the programmable switch is in the OFF position, power can still be turned on with the power button. If the programmable switch is then turned on, a brief message will appear on the LCD.

Power Menu Options

Entering the Power Menu

With the unit turned on, press the power button once briefly from any menu or screen and a menu will appear with several options. Use the arrow buttons to highlight menu items. Then press MENU/SEL to execute the item or enter a setup screen. The following options are available:

- **Resume** - returns to the previous mode and screen
- **Pwr Off** - turns the unit off irrevocably
- **Rf On?** - enters a screen to enable the operating or standby modes
- **AutoOn?** - allows the unit to automatically turn back on after a power failure or when fresh batteries are installed (works in the operating mode only)
- **Backlit** - adjusts the duration of the LCD back light to 5 seconds or 30 seconds, or to remain on
- **About** - displays model number and firmware version

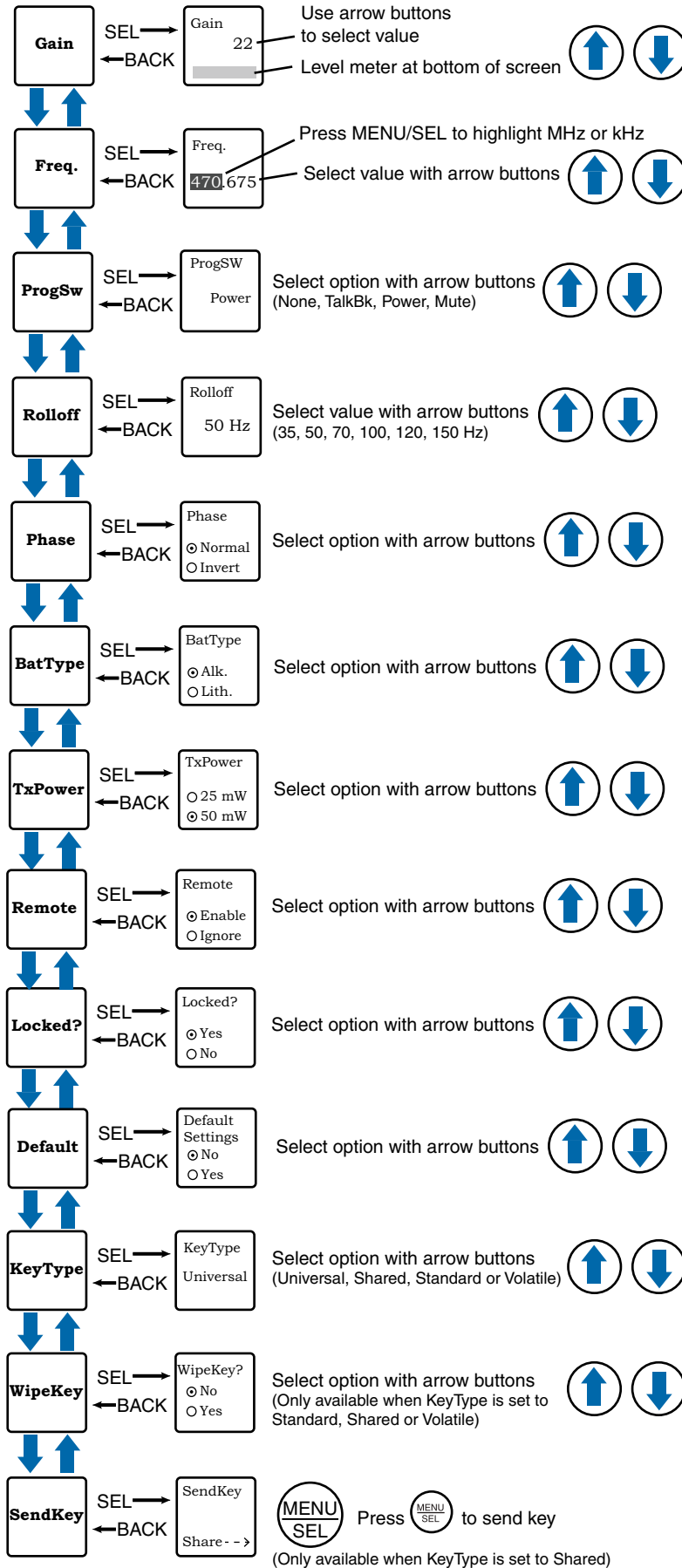

LCD Menu Map



NOTE: The settings will be stored when the BACK button is pressed.

Main Menu and Setup Screen Details

Entering the Main Menu

The LCD and keypad interface makes it easy to browse the menus and make the selections for the setup you need. When the unit is powered up in either the operating or the standby mode, press MENU/SEL on the keypad to enter a menu structure on the LCD. Use the  and  arrow buttons to select the menu item. Then press the MENU/SEL button to enter the setup screen.

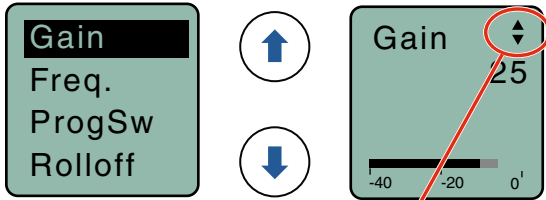

The prompt in the upper right corner may display one or both arrows, depending upon what adjustment can be made. If the changes are locked, a small padlock symbol will appear.

Main Window Indicators

The Main Window displays programmable switch function, Standby or Operating mode, operating frequency, audio level and battery status.

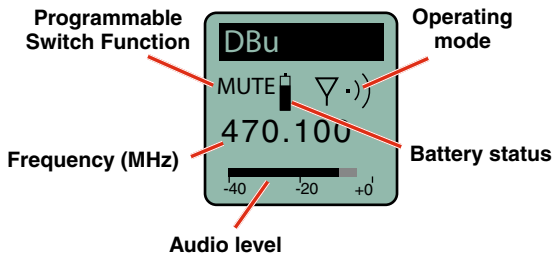

If the programmable switch function is set for Mute, the Main Window will indicate that the function is enabled.

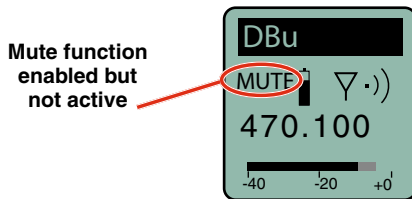

When the switch is turned on, the mute icon appearance will change and the word MUTE will blink at the bottom of the display. The -10 LED on the top panel will also glow solid red.

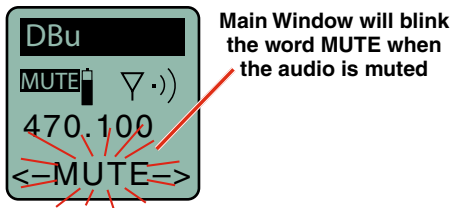

Connecting the Signal Source

Microphones, line level audio sources and instruments can be used with the transmitter. Refer to the section entitled **Input Jack Wiring for Different Sources** for details on the correct wiring for line level sources and microphones to take full advantage of the Servo Bias circuitry.

Adjusting the Input Gain

The two bicolor Modulation LEDs on the top panel provide a visual indication of the audio signal level entering the transmitter. The LEDs will glow either red or green to indicate modulation levels as shown in the following table.

Signal Level	-20 LED	-10 LED
Less than -20 dB	● Off	● Off
-20 dB to -10 dB	● Green	● Off
-10 dB to +0 dB	● Green	● Green
+0 dB to +10 dB	● Red	● Green
Greater than +10 dB	● Red	● Red

NOTE: Full modulation is achieved at 0 dB, when the “-20” LED first turns red. The limiter can cleanly handle peaks up to 30 dB above this point.



It is best to go through the following procedure with the transmitter in the standby mode so that no audio will enter the sound system or recorder during adjustment.

1) With fresh batteries in the transmitter, power the unit on in the standby mode (see previous section **Powering On in Standby Mode**).

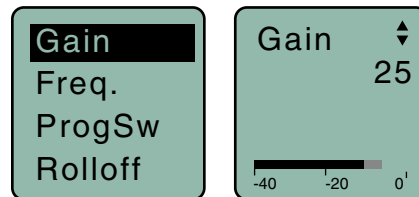
2) Navigate to the Gain setup screen.



3) Prepare the signal source. Position a microphone the way it will be used in actual operation and have the user speak or sing at the loudest level that occur during use, or set the output level of the instrument or audio device to the maximum level that will be used.

4) Use the  and  arrow buttons to adjust the gain until the -10 dB glows green and the -20 dB LED starts to flicker red during the loudest peaks in the audio.

5) Once the audio gain has been set, the signal can be sent through the sound system for overall level adjustments, monitor settings, etc.

6) If the audio output level of the receiver is too high or low, use only the controls on the receiver to make adjustments. Always leave the transmitter gain adjustment set according to these instructions, and do not change it to adjust the audio output level of the receiver.

Selecting Frequency

The setup screen for frequency selection offers two ways to browse the available frequencies.

Frequency groups are also able to be received via IR (Infrared) port sync. The group options are set by the receiver, and will show at the bottom of the screen as No Grp, Grp x, Grp w, Grp v, or Grp u.

Use the **MENU/SEL** button to toggle between options and **UP** and **DOWN** arrows to adjust.

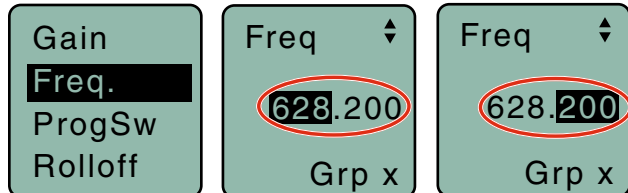

Selecting Programmable Switch Functions

The programmable switch on the top panel can be configured using the menu to provide several functions:

- **(none)** - disables the switch
- **Mute** - mutes the audio when switched on; LCD will blink a message and -10 LED will glow solid red.
- **Power** - turns the power on and off
- **TalkBk** - switches the audio output on the receiver to a different channel for communication with the production crew. Requires a receiver with this function enabled.

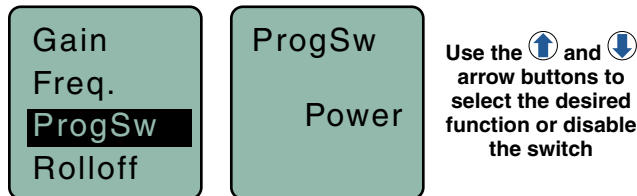

NOTE: The programmable switch will continue to operate whether or not keypad changes are locked.

Selecting the Low Frequency Roll-off

The low frequency audio roll-off is adjustable to optimize performance for ambient noise conditions or personal preference.

Low frequency audio content may be desirable or distracting, so the point at which the roll-off takes place can be set to 20, 35, 50, 70, 100, 120 or 150 Hz.

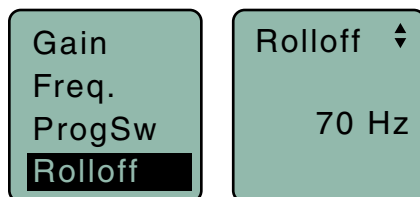

Selecting Audio Polarity (Phase)

Audio polarity can be inverted at the transmitter so the audio can be mixed with other microphones without comb filtering. The polarity can also be inverted at the receiver outputs.

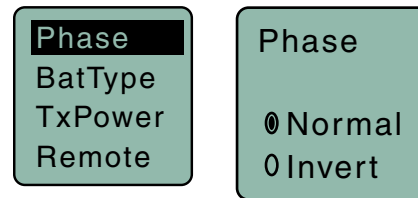

Selecting Battery Type

The voltage drop over the life of different batteries varies by type and brand. Be sure to set the correct battery type for accurate indications and warnings. The menu offers alkaline or lithium types.

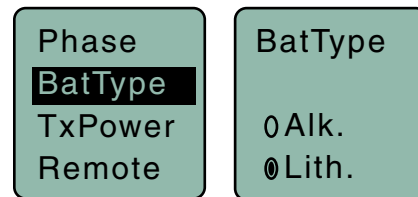

If you are using rechargeable batteries, it is better to use the timer function on the receiver to monitor the battery life rather than the indicators on the transmitter. Rechargeable batteries maintain a fairly constant voltage across the operating time on each charge and stop working abruptly, so you will have little or no warning as they reach the end of operation.

Setting Transmitter Output Power

The output power can be set to 25 mW or 50 mW.

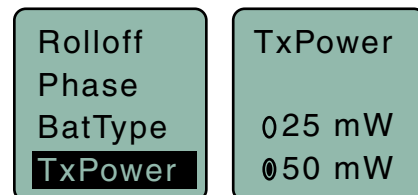

Remote

Remote control “dweedle” tones from a smart phone can be used to control the transmitter.

Locking/Unlocking Changes to Settings

Changes to the settings can be locked to prevent inadvertent changes being made.

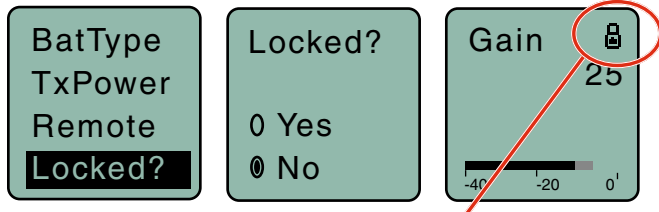

A small padlock symbol will appear on adjustment screens when changes have been locked.

When changes are locked, several controls and actions can still be used:

- Settings can still be unlocked
- Menus can still be browsed
- Programmable switch still works (Mute and On/Off)
- Power can still be turned off by using the power menu or removing the batteries.

Restoring Default Settings

This is used to restore the factory settings.

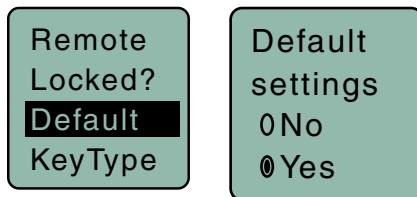

KeyType

The DBu, DBu/E01 receives an encryption via the IR port from a key generating receiver. Begin by selecting a key type in the receiver and generating a new key (key type is labeled KEY POLICY in the DSQD receiver). Set the matching KEY TYPE in the DBu, DBu/E01 and transfer the key from the receiver (SYNC KEY) to the DBu, DBu/E01 via the IR ports. A confirmation message will display on the receiver display if the transfer is successful. The transmitted audio will then be encrypted and can only be listened to if the receiver has the matching encryption key.

The DBu, DBu/E01 has three options for encryption keys:

- **Standard:** This is the highest level of security. The encryption keys are unique to the receiver and there are only 256 keys available to be transferred to a transmitter. The receiver tracks the number of keys generated and the number of times each key is transferred.

- **Shared:** There are an unlimited number of shared keys available. Once generated by a receiver and transferred to the DBu, DBu/E01, the encryption key is available to be shared (synced) by the DBu, DBu/E01 with other transmitters/receivers via the IR port. When a transmitter is set to this key type, a menu item named SEND KEY is available to transfer the key to another device.

- **Universal:** This is the most convenient encryption option available. All encryption-capable Lectrosonics transmitters and receivers contain the Universal Key. The key does not have to be generated by a receiver. Simply set the DBu, DBu/E01 and a Lectrosonics receiver to Universal, and the encryption is in place. This allows for convenient encryption amongst multiple transmitters and receivers, but not as secure as creating a unique key.

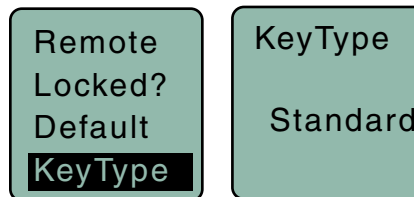

WipeKey

This menu item is only available if Key Type is set to Standard or Shared. Select Yes to wipe the current key and enable the DBu, DBu/E01 to receive a new key.

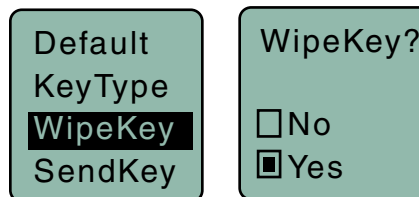

SendKey

This menu item is only available if Key Type is set to Shared. Press Menu/Sel to sync the Encryption key to another transmitter or receiver via the IR port.

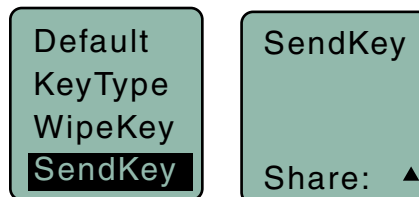

LectroRM

By New Endian LLC

LectroRM is a mobile application for iOS and Android operating systems to remotely control Lectrosonics Transmitters.

The app remotely changes settings on the transmitter through the use of encoded audio tones, which when received by the attached microphone, will alter the configured setting. The app was released by New Endian, LLC in September 2011. The app is available for download and sells for about \$20 on the Apple App Store and Google Play Store.

LectroRM's remote control mechanism is the use of an audio sequence of tones (dweedles) that are interpreted by the transmitter as a configuration change. The settings available in LectroRM are:

- Audio Level (Gain)
- Frequency
- Sleep Mode
- Lock Mode
- Output Power
- Low Frequency Roll-off
- LED on/off

User Interface

The user interface involves selecting the audio sequence related to the desired change. Each version has an interface for selecting the desired setting and the desired option for that setting. Each version also has a mechanism to prevent accidental activation of the tone.

iOS



The iPhone version keeps each available setting on a separate page with the list of options for that setting. On iOS, the "Activate" toggle switch must be enabled to show the button which will then activate the audio. The iOS version's default orientation is upside-down but can be configured to orient right-side up. The purpose for this is to orient the device's speaker, which is at the bottom of the device, closer to the transmitter microphone.

Android

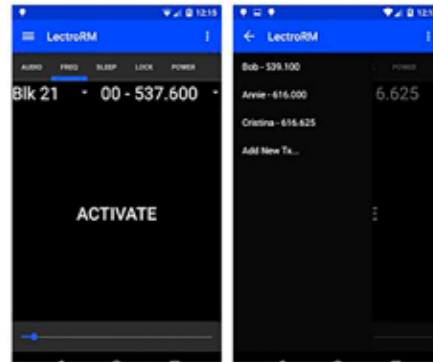

The Android version keeps all settings on the same page and allows the user to toggle between the activation buttons for each setting. The activation button must be long pressed to activate. The Android version also allows users to keep a configurable list of full sets of settings.

Activation

For a transmitter to respond to remote control audio tones, the transmitter must meet certain requirements:

- The transmitter must not be turned off; it can however be in sleep mode.
- The transmitter must have a later firmware version that enables remote control.
- Remote control must be enable on the transmitter.

Please be aware this app is not a Lectrosonics product. It is privately owned and supported by New Endian LLC, www.newendian.com.

Whip Antennas

Because the transmitter tunes across such a broad frequency range, it is best to use the appropriate antenna for maximum operation. Two antennas are included with the transmitter, and are shipped from the factory pre-cut and fully assembled. Each antenna covers three blocks. Use the chart below to determine which antenna best fits your needs.

Block	Frequency Range MHz	Cap Color	Antenna
470	470.100 - 495.600	Black	AMM19
19	486.400 - 511.900	Black	AMM19
20	512.000 - 537.500	Black	AMM19
21	537.600 - 563.100	Red	AMM22
22	563.200 - 588.700	Red	AMM22
23	588.800 - 614.300	Red	AMM22



Encryption Key and Settings Transfer

A cable between the receiver and the micro USB port on the side of the transmitter is used to transfer the encryption key from the receiver to the transmitter. This connection can also be used to send the transmitter settings stored in the receiver to the transmitter.

The interface cable, P/N DRKEYCABLE, is used to make this connection.



NOTE: Reference the DSW System Instruction Manual for instructions on Encryption Key settings and software.

Accessories

P/N 26895

Wire belt clip



BCSLEBN

Spring-loaded belt clip



DRKEYCABLE Encryption key and settings transfer cable; micro USB to male 3.5 mm TRS; 42 in. length



M152/5P 700

Lavaliere microphone; omnidirectional



M133PRA

Instrument cable; passive type for use with very high output pickups; right angle 1/4" plug



M133PST

Instrument cable; passive type for use with very high output pickups; straight 1/4" plug



MC35

Line level adapter cable; XLR-F to TA5F; 37" length



MC41

Dynamic mic level adapter cable; XLR-F to TA5F; 37" length



5-Pin Input Jack Wiring

The wiring diagrams included in this section represent the basic wiring necessary for the most common types of microphones and other audio inputs. Some microphones may require extra jumpers or a slight variation on the diagrams shown.

It is virtually impossible to keep completely up to date on changes that other manufacturers make to their products, thus you may encounter a microphone that differs from these instructions. If this occurs please call our toll-free number listed under Service and Repair in this manual or visit our web site at:

www.lectrosonics.com

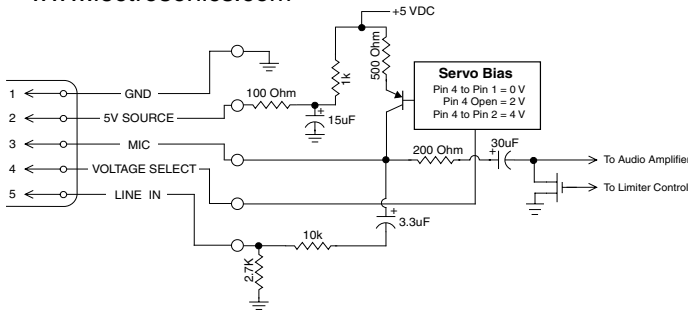

Audio input jack wiring:

PIN 1

Shield (ground) for positive biased electret lavaliere microphones. Shield (ground) for dynamic microphones and line level inputs.

PIN 2

Bias voltage source for positive biased electret lavaliere microphones that are not using servo bias circuitry and voltage source for 4 volt servo bias wiring.

PIN 3

Microphone level input and bias supply.

PIN 4

Bias voltage selector for Pin 3.
Pin 3 voltage depends on Pin 4 connection.

Pin 4 tied to Pin 1: 0 V

Pin 4 Open: 2 V

Pin 4 to Pin 2: 4 V

PIN 5

Line level input for tape decks, mixer outputs, musical instruments, etc.

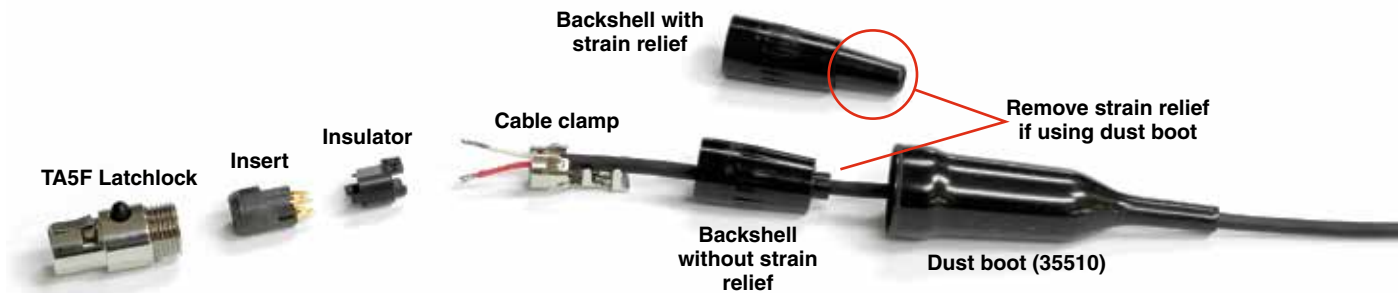

Note: If you use the dust boot, remove the rubber strain relief that is attached to the TA5F cap, or the boot will not fit over the assembly.

Installing the Connector:

- 1) If necessary, remove the old connector from the microphone cable.
- 2) Slide the dust boot onto microphone cable with the large end facing the connector.
- 3) If necessary, slide the 1/8-inch black shrink tubing onto the microphone cable. This tubing is needed for some smaller diameter cables to ensure there is a snug fit in the dust boot.
- 4) Slide the backshell over the cable as shown above. Slide the insulator over the cable before soldering the wires to the pins on the insert.
- 5) Solder the wires and resistors to the pins on the insert according to the diagrams shown in **Input Jack Wiring for Different Sources**. A length of .065 OD clear tubing is included if you need to insulate the resistor leads or shield wire.
- 6) If necessary, remove the rubber strain relief from the TA5F backshell by simply pulling it out.
- 7) Seat the insulator on the insert. Slide the cable clamp over the end of the insulator and crimp as shown on the next page.
- 8) Insert the assembled insert/insulator/clamp into the latchlock. Make sure the tab and slot align to allow the insert to fully seat in the latchlock. Thread the backshell onto the latchlock.

Microphone Cable Termination for Non-Lectrosonics Microphones

TA5F Connector Assembly

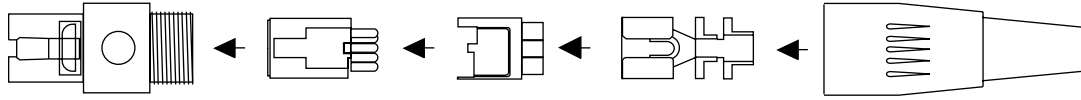

Mic Cord Stripping Instructions

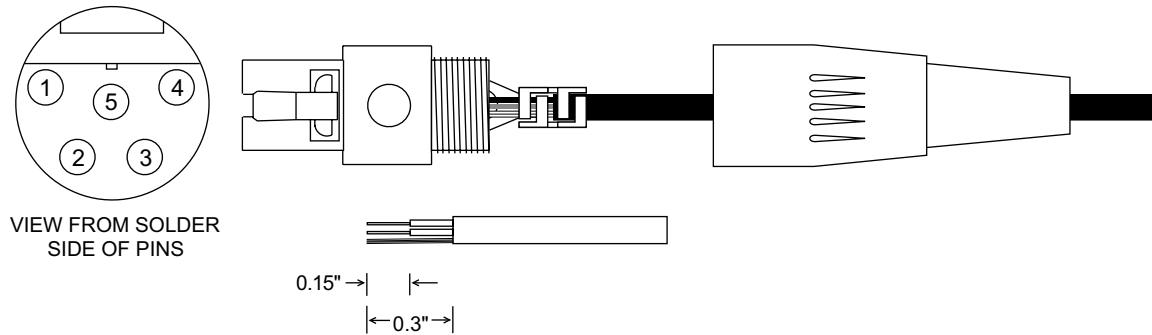

Crimping to Shield and Insulation

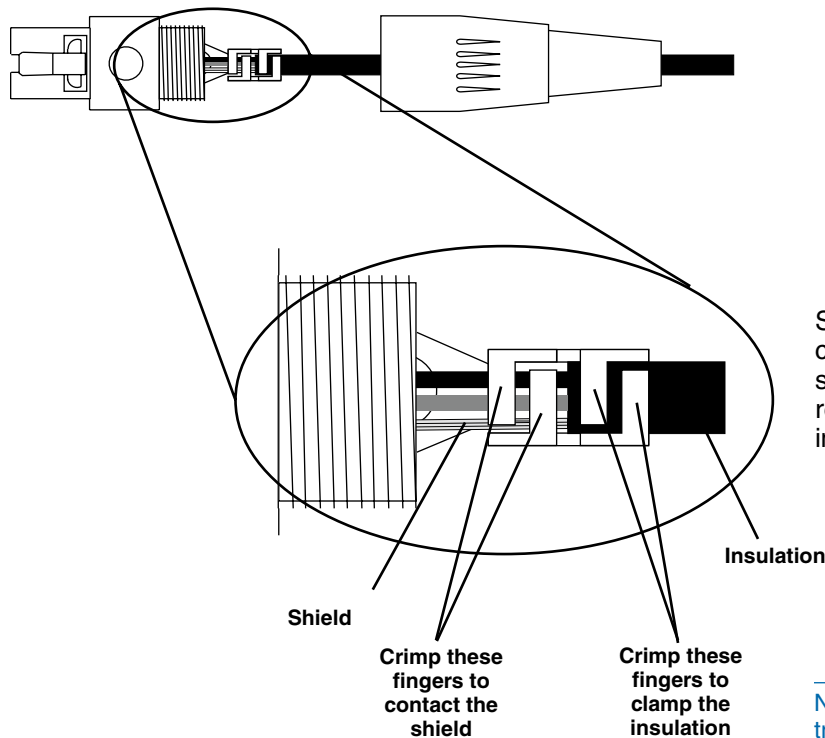

Strip and position the cable so that the clamp can be crimped to contact both the mic cable shield and the insulation. The shield contact reduces noise with some microphones and the insulation clamp increases ruggedness.

NOTE: This termination is intended for UHF transmitters only. VHF transmitters with 5-pin jacks require a different termination. Lectrosonics lavalier microphones are terminated for compatibility with VHF and UHF transmitters, which is different from what is shown here.

Input Jack Wiring for Different Sources

In addition to the microphone and line level wiring hook-ups illustrated below, Lectrosonics makes a number of cables and adapters for other situations such as connecting musical instruments (guitars, bass guitars, etc.) to the transmitter. Visit www.lectrosonics.com and click on Accessories, or download the master catalog.

A lot of information regarding microphone wiring is also available in the FAQ section of the web site at:

<http://www.lectrosonics.com/faqdb>

Follow the instructions to search by model number or other search options.

Compatible Wiring for Both Servo Bias Inputs and Earlier Transmitters:

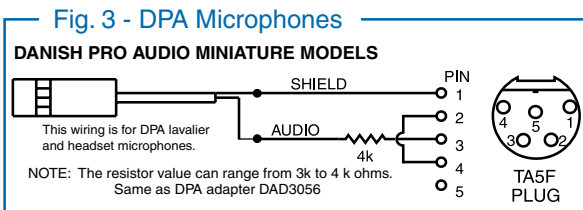
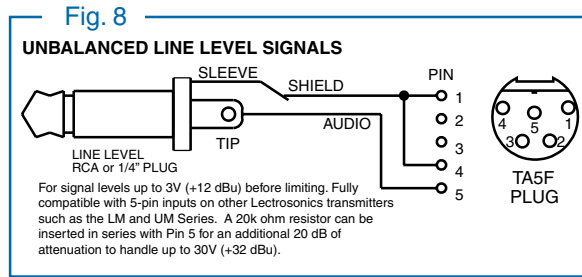
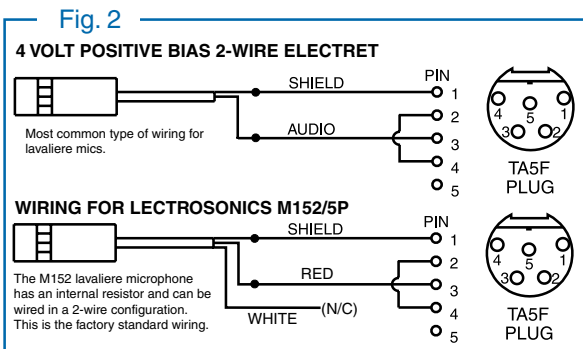
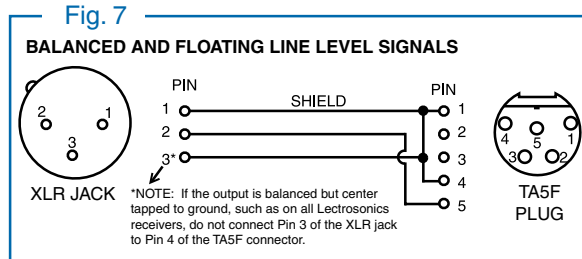
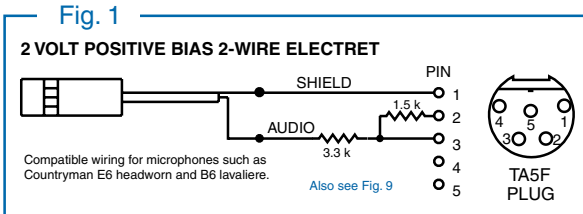

Simple Wiring - Can ONLY be used with Servo Bias Inputs:

Servo Bias was introduced in 2005 and all transmitters with 5-pin inputs have been built with this feature since 2007.

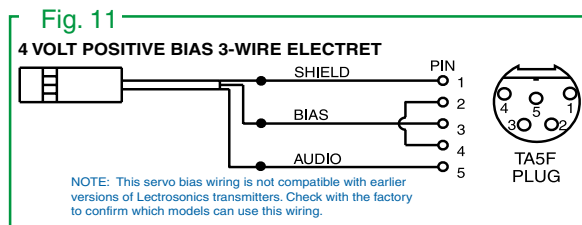
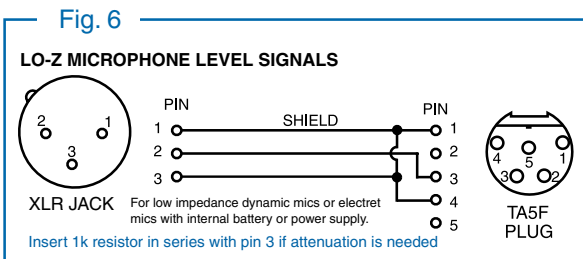
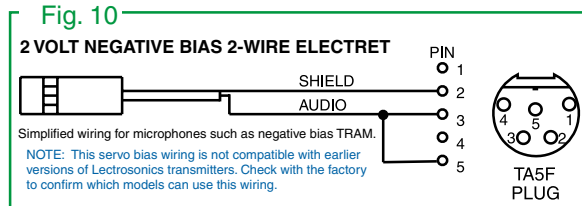
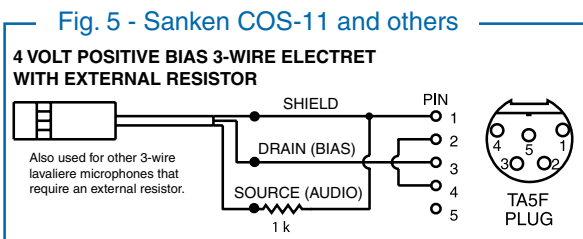
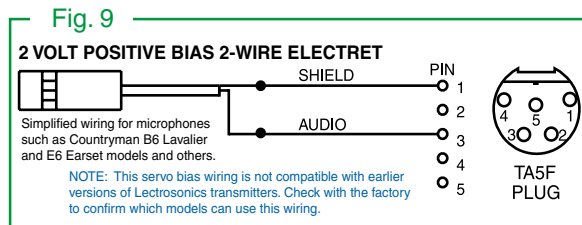
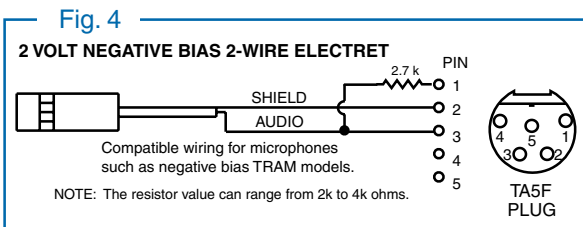

Microphone RF Bypassing

When used on a wireless transmitter, the microphone element is in the proximity of the RF coming from the transmitter. The nature of electret microphones makes them sensitive to RF, which can cause problems with microphone/transmitter compatibility. If the electret microphone is not designed properly for use with wireless transmitters, it may be necessary to install a chip capacitor in the mic capsule or connector to block the RF from entering the electret capsule.

Some mics require RF protection to keep the radio signal from affecting the capsule, even though the transmitter input circuitry is already RF bypassed.

If the mic is wired as directed, and you are having difficulty with squealing, high noise, or poor frequency response, RF is likely to be the cause.

The best RF protection is accomplished by installing RF bypass capacitors at the mic capsule. If this is not possible, or if you are still having problems, capacitors can be installed on the mic pins inside the TA5F connector housing. Refer to the diagram below for the correct locations of capacitors.

Use 330 pF capacitors. Capacitors are available from Lectrosonics. Please specify the part number for the desired lead style.

Leaded capacitors: P/N 15117

Leadless capacitors: P/N SCC330P

All Lectrosonics lavalier mics are already bypassed and do not need any additional capacitors installed for proper operation.

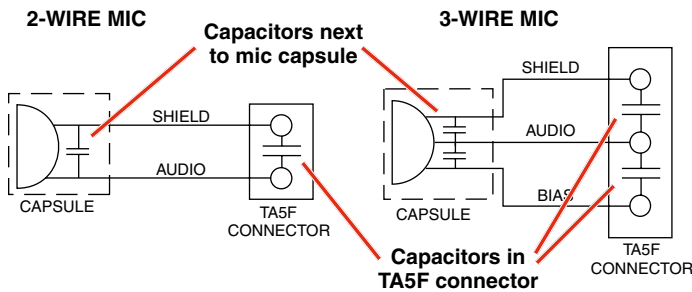

Line Level Signals

The wiring for line level and instrument signals is:

- Signal Hot to pin 5
- Signal Gnd to pin 1
- Pin 4 jumped to pin 1

This allows signal levels up to 3V RMS to be applied without limiting.

NOTE for line level inputs only (not instrument): If more headroom is needed, insert a 20 k resistor in series with pin 5. Put this resistor inside the TA5F connector to minimize noise pickup. The resistor will have little or no effect on the signal if the input is set for instrument.

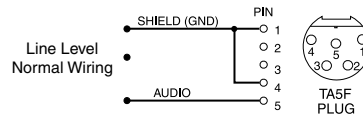

See Fig. 8 on previous page

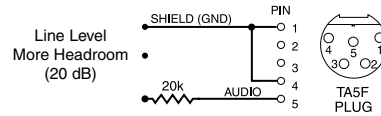

Wireless Designer Software

Download the Wireless Designer software installer from the web sites under the SUPPORT tab at:

<http://www.lectrosonics.com/US>

Wireless Designer only needs to be installed the first time the software is used. Once the software is installed, updates are available by simply clicking on an item in the Help Menu.

Note: If Wireless Designer is already installed, you must uninstall it before attempting to install a new copy.

Firmware Update Instructions

Firmware updates are made with a file downloaded from the web site and the DBu, DBu/E01 connected via USB.

The USB port on the transmitter requires a micro-B male plug on the connecting cable. The other end of the cable would normally be a USB A-Type male connector to fit the most common type of USB jack used on computers.



Refer to **Help** in Wireless Designer software for the procedure.

Specifications

Operating Frequencies:

DBu	470.100 - 607.950 MHz
DBu/E01	470.100 - 614.375 MHz

NOTE: It's the user's responsibility to select the approved frequencies for the region where the transmitter is operating

Frequency Selection Steps:	25 kHz
Audio Frequency Response:	20 Hz – 20 kHz +- 3dB
RF Power output:	Selectable; 25 or 50 mW
Frequency Stability:	± 0.002%
Digital Modulation:	8PSK
Equivalent input noise:	-128 dBV
Input level:	Nominal 2 mV to 300 mV, before limiting Greater than 1V maximum, with limiting.
Input impedance:	<ul style="list-style-type: none"> • Mic: 300 Ohm • Line: 2k Ohm
Input limiter:	Dual envelope type; 30 dB range
Gain control range:	44 dB in 1 dB steps; digital control
Modulation indicators:	<ul style="list-style-type: none"> • Dual bicolor LEDs indicate modulation of -20, -10, 0 and +10 dB referenced to full modulation • LCD bar graph
Controls:	<ul style="list-style-type: none"> • Top panel toggle switch; programmable as power, mute or none (off) function • Side panel membrane switches with LCD interface for power on/off and all setup and configuration controls
Audio Input Jack:	Switchcraft 5-pin locking (TA5F)
Antenna:	Galvanized steel, flexible wire
Battery:	Two AA Duracell Ultra recommended
Battery Life:	5 hours; Duracell Ultra alkaline
Weight:	6.24 ounces (177 grams), including two AA batteries and wire belt clip
Dimensions:	3.2 x 2.5 x .74 in. (86 x 62 x 19 mm)
Emission Designator:	200KG1E

Specifications subject to change without notice.

For body worn operation, this transmitter model has been tested and meets the FCC RF exposure guidelines when used with the Lectrosonics accessories supplied or designated for this product. Use of other accessories may not ensure compliance with FCC RF exposure guidelines. Contact Lectrosonics if you have any questions or need more information about RF exposure using this product..

This device complies with FCC radiation exposure limits as set forth for an uncontrolled environment. This device should be installed and operated so that its antenna(s) are not co-located or operating in conjunction with any other antenna or transmitter.

This device complies with ISED Canada radiation exposure limits as set forth for a controlled "professional" use only.

Cet appareil est conforme avec les normes d'Industrie Canada concernant les limites d'exposition aux radiations pour un usage professionnel contrôlé seulement.

Troubleshooting

Symptom:

Transmitter Battery LED off when Power Switch “ON”

No Transmitter Modulation LEDs when Signal Should be Present

Receiver Indicates RF But No Audio

Receiver RF Indicator Off

No Sound (Or Low Sound Level), Receiver Indicates Proper Audio Modulation

Distorted Sound

Wind Noise or Breath “Pops”

Hiss and Noise -- Audible Dropouts

Excessive Feedback (With Microphone)

It is important that you follow these steps in the sequence listed.

Possible Cause:

1. Batteries are inserted incorrectly.
 2. Batteries are low or dead.
1. Gain control turned all the way down.
 2. Batteries are inserted incorrectly. Check power LED.
 3. Mic capsule is damaged or malfunctioning.
 4. Mic cable damaged or miswired.
 5. Instrument Cable damaged or not plugged in.
 6. Musical instrument output level set too low.
1. Audio source or cable connected to transmitter is defective. Try using an alternate source or cable.
 2. Make sure the compatibility mode is the same on transmitter and receiver.
 3. Ensure musical instrument volume control is not set to minimum.
1. Ensure that the transmitter and receiver are set to the same frequency, and that the hex code matches.
 2. Transmitter not turned on, or battery is dead.
 3. Receiver antenna missing or improperly positioned.
 4. Operating distance is too great.
 5. Transmitter may be set to the Standby Mode. See page 8.
1. Receiver output level set too low.
 2. Receiver output is disconnected; cable is defective or miswired.
 3. Sound system or recorder input is turned down.
1. Transmitter gain (audio level) is too high. Check Modulation LEDs on transmitter and receiver while distortion is being heard.
 2. Receiver output level may be mismatched with the sound system or recorder input. Adjust output level on receiver to the correct level for the recorder, mixer or sound system.
 3. RF interference. Reset both transmitter and receiver to a clear channel. Use scanning function on receiver if available.
1. Reposition microphone, or use a larger windscreen, or both.
 2. Omni-directional mics produce less wind noise and breath pops than directional types.
1. Transmitter gain (audio level) far too low.
 2. Receiver antenna missing or obstructed.
 3. Operating distance too great.
 4. RF interference. Reset both transmitter and receiver to a clear channel. Use scanning function on receiver if available.
 5. Musical instrument output set too low.
 6. Microphone capsule picking up RF noise. See item on page 17 entitled **Microphone RF Bypassing**.
1. Transmitter gain (audio level) too high. Check gain adjustment and/or reduce receiver output level.
 2. Microphone too close to speaker system.
 3. Microphone is too far from user's mouth.

Service and Repair

If your system malfunctions, you should attempt to correct or isolate the trouble before concluding that the equipment needs repair. Make sure you have followed the setup procedure and operating instructions. Check the interconnecting cables and then go through the **Troubleshooting** section in this manual.

We strongly recommend that you **do not** try to repair the equipment yourself and **do not** have the local repair shop attempt anything other than the simplest repair. If the repair is more complicated than a broken wire or loose connection, send the unit to the factory for repair and service. Don't attempt to adjust any controls inside the units. Once set at the factory, the various controls and trimmers do not drift with age or vibration and never require readjustment. **There are no adjustments inside that will make a malfunctioning unit start working.**

LECTROSONICS' Service Department is equipped and staffed to quickly repair your equipment. In warranty repairs are made at no charge in accordance with the terms of the warranty. Out-of-warranty repairs are charged at a modest flat rate plus parts and shipping. Since it takes almost as much time and effort to determine what is wrong as it does to make the repair, there is a charge for an exact quotation. We will be happy to quote approximate charges by phone for out-of-warranty repairs.

Returning Units for Repair

For timely service, please follow the steps below:

- A.** DO NOT return equipment to the factory for repair without first contacting us by email or by phone. We need to know the nature of the problem, the model number and the serial number of the equipment. We also need a phone number where you can be reached 8 A.M. to 4 P.M. (U.S. Mountain Standard Time).
- B.** After receiving your request, we will issue you a return authorization number (R.A.). This number will help speed your repair through our receiving and repair departments. The return authorization number must be clearly shown on the **outside** of the shipping container.
- C.** Pack the equipment carefully and ship to us, shipping costs prepaid. If necessary, we can provide you with the proper packing materials. UPS is usually the best way to ship the units. Heavy units should be "double-boxed" for safe transport.
- D.** We also strongly recommend that you insure the equipment, since we cannot be responsible for loss of or damage to equipment that you ship. Of course, we insure the equipment when we ship it back to you.

Lectrosonics USA:

Mailing address:

Lectrosonics, Inc.
PO Box 15900
Rio Rancho, NM 87174
USA

Shipping address:

Lectrosonics, Inc.
561 Laser Rd. NE, Suite 102
Rio Rancho, NM 87124
USA

Telephone:

(505) 892-4501
(800) 821-1121 Toll-free
(505) 892-6243 Fax

Web:

www.lectrosonics.com

E-mail:

sales@lectrosonics.com
service.repair@lectrosonics.com

Lectrosonics Canada:

Mailing Address:

720 Spadina Avenue,
Suite 600
Toronto, Ontario M5S 2T9

Telephone:

(416) 596-2202
(877) 753-2876 Toll-free
(877-7LECTRO)
(416) 596-6648 Fax

E-mail:

Sales: colinb@lectrosonics.com
Service: joeb@lectrosonics.com



P.O. Box 15900 - Rio Rancho, NM - 87174 - USA
 Phone: (800)821-1121 or (505)892-4501 - Fax: (505)892-6243
 web: www.lectrosonics.com - email: sales@lectrosonics.com

EU Declaration of Conformity

LECTROSONICS, INC.
 581 Laser Road
 Rio Rancho, NM 87124 USA

Declares under our sole responsibility that the following product:

Model: DBU/E01

Wireless microphone transmitter

is in conformity with the provisions of the following EC directive(s) (including applicable amendments) and are designed and manufactured in accordance with the harmonized standards:

Document	Description	Date/Version
RL 2014/53/EU	Radio Equipment Directive 2014/53/EU (RED)	2014-04
EN 300 422-1	Wireless Microphones; Audio PMSE up to 3 GHz; Part 1: Class A Receivers	V2.1.2 (2017-01)
	Electromagnetic Compatibility	
EN 301 489-1	ElectroMagnetic Compatibility (EMC) standard for radio equipment and services; Common Technical Requirements	V2.2.0 (2017-03)
EN 301 489-9	Specific Conditions for wireless microphones, similar Radio Frequency (RF) audio link equipment, cordless audio and in-ear monitoring devices	V2.1.1 (2017-03)
	Safety and Health	
EN 60065-1	Audio, video and similar electronic apparatus – Safety Requirements	2014
EN 62311	Assessment of electronic and electrical equipment related to human exposure restrictions for electromagnetic fields (0 Hz – 300 GHz)	2008
RL 2011/65/EU	RoHS Directive 2011/65/EU: Restriction of the use of certain hazardous substances (RoHS Recast)	2011

The EU type examination was performed by notified body Bay Area Compliance Laboratories.

Software version of DBU/E01: v0.10

Rio Rancho, NM USA, 06 Sep 2017

Robert Cummings
 V.P. Engineering
 Lectrosonics, Inc.

LIMITED ONE YEAR WARRANTY

The equipment is warranted for one year from date of purchase against defects in materials or workmanship provided it was purchased from an authorized dealer. This warranty does not cover equipment which has been abused or damaged by careless handling or shipping. This warranty does not apply to used or demonstrator equipment.

Should any defect develop, Lectrosonics, Inc. will, at our option, repair or replace any defective parts without charge for either parts or labor. If Lectrosonics, Inc. cannot correct the defect in your equipment, it will be replaced at no charge with a similar new item. Lectrosonics, Inc. will pay for the cost of returning your equipment to you.

This warranty applies only to items returned to Lectrosonics, Inc. or an authorized dealer, shipping costs prepaid, within one year from the date of purchase.

This Limited Warranty is governed by the laws of the State of New Mexico. It states the entire liability of Lectrosonics Inc. and the entire remedy of the purchaser for any breach of warranty as outlined above. NEITHER LECTROSONICS, INC. NOR ANYONE INVOLVED IN THE PRODUCTION OR DELIVERY OF THE EQUIPMENT SHALL BE LIABLE FOR ANY INDIRECT, SPECIAL, PUNITIVE, CONSEQUENTIAL, OR INCIDENTAL DAMAGES ARISING OUT OF THE USE OR INABILITY TO USE THIS EQUIPMENT EVEN IF LECTROSONICS, INC. HAS BEEN ADVISED OF THE POSSIBILITY OF SUCH DAMAGES. IN NO EVENT SHALL THE LIABILITY OF LECTROSONICS, INC. EXCEED THE PURCHASE PRICE OF ANY DEFECTIVE EQUIPMENT.

This warranty gives you specific legal rights. You may have additional legal rights which vary from state to state.



581 Laser Road NE • Rio Rancho, NM 87124 USA • www.lectrosonics.com
(505) 892-4501 • (800) 821-1121 • fax (505) 892-6243 • sales@lectrosonics.com

9 August 2019