



VT1601LED
LCD TV
User Guide

IMPORTANT: Please read this User Guide to obtain important information on installing and using your product in a safe manner, as well as registering your product for future service. Warranty information contained in this User Guide will describe your limited coverage from ViewSonic Corporation, which is also found on our web site at <http://www.viewsonic.com> in English, or in specific languages using the Regional selection box in the upper right corner of our website. "Antes de operar su equipo lea cuidadosamente las instrucciones en este manual"

Model No. VS14862-1M

Compliance Information

FCC Statement

This device complies with part 15 of FCC Rules. Operation is subject to the following two conditions: (1) this device may not cause harmful interference, and (2) this device must accept any interference received, including interference that may cause undesired operation.

This equipment has been tested and found to comply with the limits for a Class B digital device, pursuant to part 15 of the FCC Rules. These limits are designed to provide reasonable protection against harmful interference in a residential installation. This equipment generates, uses, and can radiate radio frequency energy, and if not installed and used in accordance with the instructions, may cause harmful interference to radio communications. However, there is no guarantee that interference will not occur in a particular installation. If this equipment does cause harmful interference to radio or television reception, which can be determined by turning the equipment off and on, the user is encouraged to try to correct the interference by one or more of the following measures:

- Reorient or relocate the receiving antenna.
- Increase the separation between the equipment and receiver.
- Connect the equipment into an outlet on a circuit different from that to which the receiver is connected.
- Consult the dealer or an experienced radio/TV technician for help.

Warning: You are cautioned that changes or modifications not expressly approved by the party responsible for compliance could void your authority to operate the equipment.

Following information is only for EU-member states:

The mark shown to the right is in compliance with the Waste Electrical and Electronic Equipment Directive 2002/96/EC (WEEE).

The mark indicates the requirement NOT to dispose the equipment as unsorted municipal waste, but use the return and collection systems according to local law.

If the batteries, accumulators and button cells included with this equipment, display the chemical symbol Hg, Cd, or Pb, then it means that the battery has a heavy metal content of more than 0.0005% Mercury or more than, 0.002% Cadmium, or more than 0.004% Lead.



ENERGY STAR Information:

To ensure your television is operating at optimal energy efficiency, select [Home] mode during initial activation.

To return to [Home] mode settings, select [Standard] picture mode. [Standard] mode is recommended for normal home use.

Keeping the TV at its factory default settings that meet ENERGY STAR criteria.

Enabling certain features and functionality of LED TV will increase its energy consumption, possibly beyond the limits required for ENERGY STAR qualification.

SRS Trademark Information:



- **TruSurround HD** is a trademark of SRS Labs, Inc. TruSurround HD technology is incorporated under license from SRS Labs, Inc.

SRS TruSurround HD™ creates an immersive, feature-rich surround sound experience from two speakers, complete with rich bass, high frequency detail and clear dialog.

Declaration of RoHS Compliance

This product has been designed and manufactured in compliance with Directive 2002/95/EC of the European Parliament and the Council on restriction of the use of certain hazardous substances in electrical and electronic equipment (RoHS Directive) and is deemed to comply with the maximum concentration values issued by the European Technical Adaptation Committee (TAC) as shown below:

Substance	Proposed Maximum Concentration	Actual Concentration
Lead (Pb)	0.1%	< 0.1%
Mercury (Hg)	0.1%	< 0.1%
Cadmium (Cd)	0.01%	< 0.01%
Hexavalent Chromium (Cr ⁶⁺)	0.1%	< 0.1%
Polybrominated biphenyls (PBB)	0.1%	< 0.1%
Polybrominated diphenyl ethers (PBDE)	0.1%	< 0.1%

Certain components of products as stated above are exempted under the Annex of the RoHS Directives as noted below:

Examples of exempted components are:

1. Mercury in compact fluorescent lamps not exceeding 5 mg per lamp and in other lamps not specifically mentioned in the Annex of RoHS Directive.
2. Lead in glass of cathode ray tubes, electronic components, fluorescent tubes, and electronic ceramic parts (e.g. piezoelectronic devices).
3. Lead in high temperature type solders (i.e. lead-based alloys containing 85% by weight or more lead).
4. Lead as an alloying element in steel containing up to 0.35% lead by weight, aluminium containing up to 0.4% lead by weight and as a copper alloy containing up to 4% lead by weight.

Copyright Information

Copyright © ViewSonic® Corporation, 2012. All rights reserved.

ViewSonic, the three birds logo, OnView, ViewMatch, and ViewMeter are registered trademarks of ViewSonic Corporation.

ENERGY STAR® is a registered trademark of the U.S. Environmental Protection Agency (EPA).

As an ENERGY STAR® partner, ViewSonic Corporation has determined that this product meets the ENERGY STAR® guidelines for energy efficiency.

Disclaimer: ViewSonic Corporation shall not be liable for technical or editorial errors or omissions contained herein; nor for incidental or consequential damages resulting from furnishing this material, or the performance or use of this product.

In the interest of continuing product improvement, ViewSonic Corporation reserves the right to change product specifications without notice. Information in this document may change without notice.

No part of this document may be copied, reproduced, or transmitted by any means, for any purpose without prior written permission from ViewSonic Corporation.

Product Registration

To meet your future needs, and to receive any additional product information as it becomes available, please register your product on the Internet at: www.viewsonic.com.

For Your Records

Product Name:	VT1601LED ViewSonic LED TV
Model Number:	VS14862-1M
Document Number:	VT1601LED-1M_UG_ENG Rev. 1A 06-01-12
Serial Number:	_____
Purchase Date:	_____

Product disposal at end of product life

ViewSonic respects the environment and is committed to working and living green. Thank you for being part of Smarter, Greener Computing. Please visit ViewSonic website to learn more.

USA & Canada: <http://www.viewsonic.com/company/green/recycle-program/>

Europe: <http://www.viewsoniceurope.com/uk/support/recycling-information/>

Taiwan: <http://recycle.epa.gov.tw/recycle/index2.aspx>

IMPORTANT SAFETY INSTRUCTIONS

1. Read these instructions.
2. Keep these instructions.
3. Heed all warnings.
4. Follow all instructions.
5. Do not use this apparatus near water.
6. Clean only with dry cloth.
7. Do not block any ventilation openings. Install in accordance with the manufacturer's instructions.
8. Do not install near any heat sources such as radiators, heat registers, stoves, or other apparatus (including amplifiers) that produce heat.
9. Do not defeat the safety purpose of the polarized or grounding-type plug. A polarized plug has two blades with one wider than the other. A grounding type plug has two blades and a third grounding prong. The wide blade or the third prong are provided for your safety. If the provided plug does not fit into your outlet, consult an electrician for replacement of the obsolete outlet.
10. Protect the power cord from being walked on or pinched particularly at plugs, convenience receptacles, and the point where they exit from the apparatus.
11. Only use attachments/accessories specified by the manufacturer.
12. Use only with the cart, stand, tripod, bracket, or table specified by the manufacturer, or sold with the apparatus. When a cart is used, use caution when moving the cart/apparatus combination to avoid injury from tip-over. 
13. Unplug this apparatus during lightning storms or when unused for long periods of time.
14. Refer all servicing to qualified service personnel. Servicing is required when the apparatus has been damaged in any way, such as power-supply cord or plug is damaged, liquid has been spilled or objects have fallen into the apparatus, the apparatus has been exposed to rain or moisture, does not operate normally, or has been dropped.

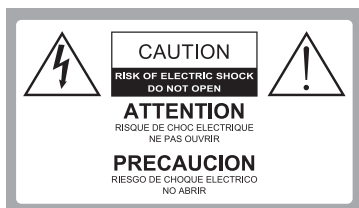

Dangerous Voltage: The lightning flash with arrowhead symbol, within an equilateral triangle, is intended to alert the user to the presence of dangerous voltage within the inside of the product that may be sufficient level to constitute a risk of electric shock to persons.



Instruction: The exclamation point within an equilateral triangle is intended to alert the user to the presence of important operating and servicing instructions in the literature accompanying the appliance.

15. **WARNING:** To Reduce The Risk Of Fire Or Electric Shock, Do Not Expose This Apparatus To Rain Or Moisture
16. Apparatus shall not be exposed to dripping or splashing and no objects filled with liquids, such as vases, shall be placed on the apparatus
17. The mains plug or appliance coupler shall remain readily opeable.

USE

AC power Cord

Keep the following guidelines to protect the AC power cord from being damaged. If the AC power cord is damaged, it may result in a fire or an electric shock. Stop using it and ask your dealer or ViewSonic service center to exchange it.

- Do not place the TV where the power cord is subject to wear or abuse.
- Do not pinch, bend, or twist the cord excessively.
- The core lines may be bared and cut, causing a short-circuit, and resulting in a fire or an electric shock.
- Do not convert or damage the power cord.
- Avoid power cord being rolled over or rested upon.
- When the power cord is plugged in, do not move the TV. 
- Keep the power cord away from heat sources.
- When you disconnect the AC power cord, disconnect it from the wall outlet first.
- When disconnecting the power cord, grasp the plug instead of pulling the power cord.
- Use only an original ViewSonic AC power cord, not other brands.
- Do not use the supplied AC power cord on any other equipment.

Wall outlet

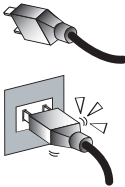
Insert the plug fully into the outlet. If it is loose, do not use it. Doing so may cause arcing and result in a fire. Contact your electrician to change the outlet. 

Wiring

For your safety, be sure to unplug the AC power cord when connecting cables.

Take care not to trip on the cables. It may cause damage to the TV set. 

Electric shock

Do not touch the AC power cord or the TV with a wet hand. If you plug/unplug the AC power cord from the TV with a wet hand, it may cause electric shock.

Lightning storms

During a lightning storm, unplug the TV from the wall outlet and disconnect the antenna to prevent damage to the TV.

When not in use

If you will not be using the TV set for long periods of time, the TV set should be disconnected from the AC power outlet to prevent power line surges. The TV set is not disconnected from the AC power source when the TV set is switched off.

To disconnect the TV set completely, unplug from the AC power outlet.

Overloading

This TV set is designed to operate on a 120V AC supply only.

If there are too many appliances connected to the same AC power outlet, it could result in a fire or an electric shock.

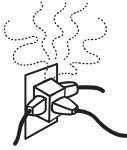

Optional equipment

If optional equipment is to be installed, leave some space between optional equipment and the TV set. Picture distortion and/or noisy sound may occur if the TV set is positioned in close proximity to any equipment emitting electromagnetic radiation.

Small accessories

Keep small accessories in a safe place where children are unable to reach.

Magnetic influence

This TV contains a strong magnet in the speaker unit that generates a magnetic field. Keep any items susceptible to magnetic fields away from the speaker.

Sound

If you hear snapping or popping sound comes from the TV continuously or frequently while the TV is operating,



unplug the TV and consult your dealer or service technician. It is normal for some TVs to make occasional snapping or popping sounds, particularly when being turned on or off.

Use in outdoor

This TV is not designed for outdoors installation. Do not expose the TV to rain, as it may result in a fire or an electric shock. Also, do not expose the TV to direct sunlight, as it may heat up and become damaged.

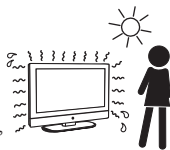

Vehicle, ships and other vessels

Do not install this TV in a vehicle. Car accidents may cause the TV to fall down and cause injury.

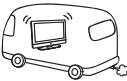

Do not install this TV in a ship or vessel.

If the TV is exposed to seawater, it may cause a fire or damage the TV.



Medical institutions

Do not place this TV in a place where medical equipment is in use. It may cause the medical equipment to malfunction.

Volume adjustment

- Adjust the volume to avoid disturbing your neighbors. Sound carries easily at night. Therefore, we suggest you close the windows or use headphones.
- When using headphones, adjust the volume to appropriate levels, or hearing damage may result.

ANTENNAS

Outdoor antenna grounding

If an outdoor antenna is installed, follow the precautions below. Do not install the outdoor antenna system near of overhead power lines or other electric light or power circuits, or where it can come in contact with such power lines or circuits.

WHEN INSTALLING AN OUTDOOR ANTENNA SYSTEM, EXTREME CARE SHOULD BE TAKEN TO KEEP FROM CONTACTING SUCH POWER LINES OR CIRCUITS AS CONTACT WITH THEM IS ALMOST INVARIABLY FATAL. Be sure the antenna system is grounded so that it can provide

some protection against voltage surges and built-up static charges.

Section 810 of the National Electrical Code (NEC) in the U.S.A. and Section 54 of the Canadian Electrical Code in Canada provides information with in regard to proper grounding of the mast and supporting structure, grounding of the lead-in wire to an antenna discharge unit, size of grounding conductors, location of antenna discharge unit, connection to grounding electrodes, and requirements for the grounding electrode.

Antenna grounding according to the National Electrical Code, ANS/NFPA 70

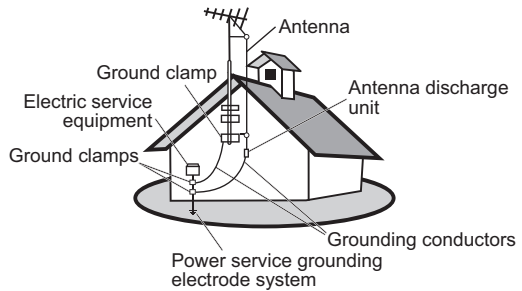

CLEANING

Cleaning the AC power plug

Unplug the AC power plug and clean it regularly. If the plug is covered with dust and gathers moisture, its insulation may deteriorate and result in a fire.

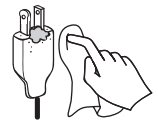

Cleaning the screen surface/ cabinet of the TV set

When cleaning this TV, unplug the AC power cord. If not, it may result in electric shock. Use a dry soft cloth to clean the cabinet of the TV. To remove dust near the screen, wipe it gently with a soft cloth. Stubborn stains may be removed with a cloth slightly dampened with a solution of mild soap and warm water. Never use strong solvents such as thinner or benzine for cleaning. If using a chemically pretreated cloth, please follow the instruction provided on the package. The ventilation holes can accumulate dust over time.



To ensure proper ventilation, we recommend you to remove the dust periodically (once a month) using a vacuum cleaner, while the LED TV is powered off.

Disclaimer

Some chemical cleaners have been reported to damage the screen and/or case of the LCD TV. ViewSonic will not be liable for damage resulting from use of these cleaners.

CARRYING THE TV

Carry the TV as instructed

To prevent dropping the TV and causing serious injury, you must follow these guidelines:

- Disconnect all cables before carrying the TV.
- Carrying the large size TV requires at least two or three people.
- When you carry the TV, place your hands as illustrated and hold it securely. Do not put stress on the LCD panel and the frame around the screen.
- When carrying the TV, do not subject it to shocks, vibration,

or excessive force.

- When lifting or moving the TV, hold it securely from the bottom. Place your palm directly under the panel.

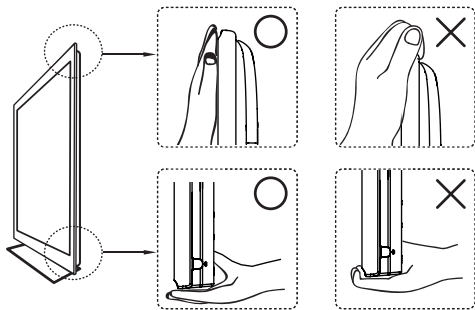

VENTILATION

Slots and openings in TV are provided for ventilation. To ensure reliable operation of the TV and to protect it from overheating, be sure these openings are not blocked or covered.

The TV may accumulate dust and get dirty if proper ventilation is not provided. For proper ventilation, follow the following guidelines:

- Never install the TV face up, down or sideways.
- Never install the TV turned over or upside down.
- Never cover the slots and openings with a cloth or other materials.
- Never block the slots and openings by placing the TV on a bed, sofa, rug or other similar surface.
- Never place the TV in a confined space, such as a bookcase or built-in cabinet, unless proper ventilation is provided.



Leave some space around the TV set as shown below. Otherwise, air-circulation may be inadequate and cause overheating, which may cause a fire or damage to the TV set.

Installed on the wall

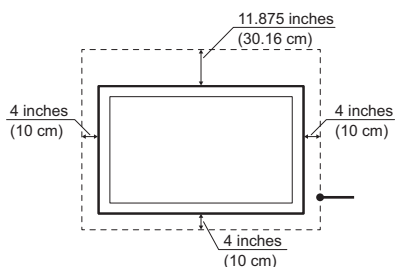

Installed with stand

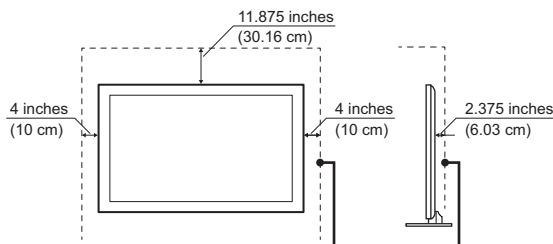

Leave at least this space around the set.

Do not install the TV set as follows:

Air circulation is blocked.

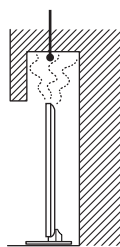

Air circulation is blocked.

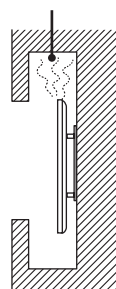

Objects and ventilation holes

Never push any objects into the slots on the TV cabinet as they may touch dangerous voltage points or short out parts that could result in a fire or an electric shock. Do not place any objects on the TV.

MOISTURE

Moisture and flammable objects

- Keep the product away from moisture. Do not expose this appliance to rain or moisture. Do not place objects filled with liquids, such as vases, on the TV.
- Do not use power-line operated V sets near water, such as in places like a bathtub, washbowl, kitchen sink, laundry tub, a wet basement, or near a swimming pool, etc. It may cause fire or electric shock.
- Do not let this TV get wet. Never spill liquid of any kind on the TV. If water penetrates into the product, unplug the power cord and contact ViewSonic.
- Do not operate the TV when wet. It may result in electric shock or damage to the TV.
- To prevent fire, keep flammable objects or open flame (e.g. candles) away from the TV.

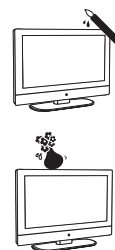

INSTALLATION

Optional wall mount

To do Wall mount installation, you need a Wall-Mount Bracket. When installing or removing the TV using the Wall-Mount Bracket, be sure to use qualified contractors. If not properly secured during installation or removal from the Wall-Mount Bracket, the TV may fall and cause serious injury.

- When installing the TV using a Wall-Mount Bracket, make sure you follow the operating instructions supplied with the Wall-Mount Bracket.
- Attach the brackets supplied with the Wall-Mount Bracket.
- The TV is not designed for hanging from the ceiling. It may fall and cause serious injury.

Placement

The TV should be installed near an easily accessible AC power outlet.

Observe the following to prevent the TV from falling from the stand or wall mount.

- Place the TV on a stable, level surface.
- Do not hang anything on the TV. Do not allow

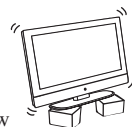

children to climb on the TV.

- Do not install the TV in places subject to extreme temperature, such as in direct sunlight, near a radiator, or heating vent. If the TV is exposed to extreme temperature, the TV may overheat and cause deformation of the enclosure or cause malfunction.
- Do not install the TV in a place exposed to direct air conditioning.
- If the TV is installed in such a location, moisture may condense inside and may cause a malfunction.
- Do not place the TV in hot, oily, humid or excessively dusty places.
- Do not install the TV where insects may enter.
- Do not install the TV where it may be exposed to mechanical vibration.
- Do not install the TV in a location where it may spear up, such as on or behind a pillar, or where you might bump your head on it. It may cause injury.



Preventing the TV from toppling over

To prevent the TV from toppling over, secure the TV to a wall or stand.

Placement for watching

We suggest you to watch the TV at a distance of 3-7 times that of the screen height, and not in excessive brightness. It is easy to cause eye fatigue if you watch TV for too long or in a dark room. To obtain clear picture, do not expose the screen to direct illumination or sunlight. Use spot lighting directed down from the ceiling if you can.

LCD SCREEN

- Although the LCD screen is made with high precision technology and has effective pixels of 99.99% or more, black dots or bright points or light (red, blue, or green) may appear constantly on the LCD screen. This is a structural property of the LCD panel and is not a malfunction.
- The LCD screen is made with high-precision technology. To achieve a high level of performance and picture quality, this TV's backlight setting is set to maximize the brightness of the TV. However, uneven brightness may be observed when the LED TV is viewed in a dark environment without an input source or a blank screen. This is a normal condition, not a malfunction of the TV. To improve this condition, change the Picture mode, Backlight setting, enable the Light Sensor, or turn on the Power management.
- Avoid exposing the LCD screen surface to direct sunlight. It is likely to damage the LCD panel.
- Do not push or scratch the LCD screen, or place objects on top of the TV. The image may be uneven or the LCD panel may be damaged.
- If the TV is used in a cold place, a smear may occur in the picture or the picture may become dark. It is not caused by a failure. This condition will improve as the temperature rises.
- When still pictures are displayed continuously, ghosting may occur. It should disappear after a short period of time.
- The screen and cabinet get warm when the TV is in use. This is a normal condition.
- Spraying insect repellent with volatile material on the screen

will cause damage.

- Do not make prolonged contact with rubber or plastic material.

Broken pieces

Do not throw anything at the TV.

Doing so may break the screen glass and cause serious injury.



If the surface of the TV cracks, unplug the AC power cord before touching the TV. Otherwise electric shock may result.

Handling of broken glass and liquid crystal leakage

If the LCD panel gets damaged, crystalline liquid leakage may occur, or scattered broken glass may result. Do not touch broken glass or crystalline liquid which is toxic, with bare hands as cuts, poisoning or skin irritation may occur. Also do not glass fragments or leaked crystalline liquid get into your eyes or mouth. Should either contacted your eyes or mouth, rinse the contacted area thoroughly with water and consult your doctor.

SERVICING

Do not attempt to repair the TV yourself, since opening the cabinet may expose you to dangerous voltage or other hazards. Ask qualified service personnel to do the servicing for your TV.



Replacement parts

When replacement parts are required, be sure the service technician certifies in writing that he/she has used replacement parts specified by the manufacturer that have the same characteristics as the original parts. Unauthorized substitutions may cause a fire, an electric shock or other hazards.

Safety check

Upon completion of repairs to the TV, ask the service technician to perform routine safety checks (as specified by the manufacturer) to determine that the TV is safe for operating, and to so certify.

Ask a qualified service technician to dispose of the TV.

Getting Started

Package Contents

Please make sure the following items are included with your LCD TV.
If any items are missing, please contact your dealer.



LCD TV



Remote Control
with batteries



Power Cord



Adapter

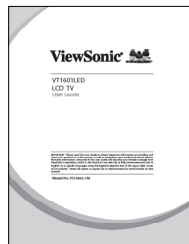

ViewSonic User Guide



ViewSonic Quick Start Guide

Installing the LCD TV

Installing the Stand

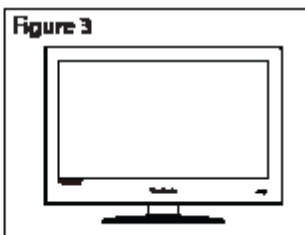
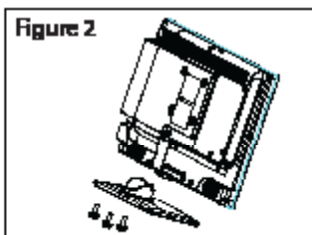
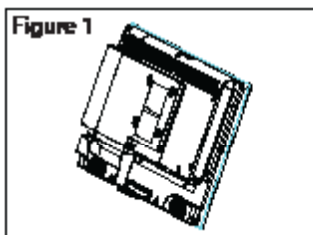

1. Lay the TV flat on a table with the LCD screen face down. To prevent the TV from being scratched, put a piece of soft cloth on the table on which the screen will be set. (see Figure 1)
2. Unpack the stand, one hand hold the TV and one hand pull stand with arm together. (see Figure 2)
3. Stand the TV up. (see Figure 3)

Disconnecting the Stand

1. Lay the TV flat on a table with the LCD screen face down. To prevent the TV from being scratched, put a piece of soft cloth on the table on which the screen will be set. (see Figure 1)
2. Remove the 4 screws on the hinge, then pull up the stand slowly. (see Figure 2)
3. Then, you shall successfully uninstall the stand. (see Figure 3)

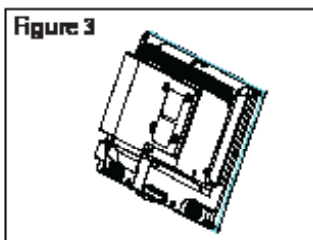
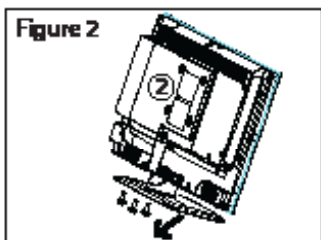
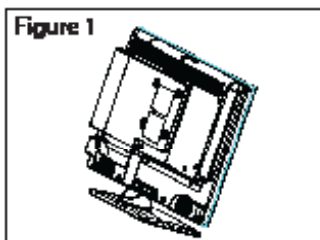

Mounting ViewSonic LCD TV to the wall

The LCD TV can be used in a free standing position or wall-mounted. Before installing the product to the wall, please consider the following guidelines:

- Read the Important Safety Instructions, at the start of this manual.
- Do **not** install in a moist or wet environment. This equipment is intended for indoor use.
- Do **not** install near heat source, or strong magnetic fields.
- Use only ViewSonic approved wall-mounting brackets to support the LCD TV weight.
- Before attaching the wall mount plate to the back cover, ensure the product is working.
- If your LCD TV is already set up for free-standing operation, you need to first remove the stand before mounting the device to the wall.

To attach the wall-mount bracket to LCD TV safely, please use the following guidelines:

- Disconnect the power and any other cables that might hinder moving the LCD TV.
- Set the LCD TV on a table or work surface, placing the screen face down on a towel or woolen blanket to protect the screen surface from damage while installing plate.
- Before installing the LCD TV on the wall, ensure you have recorded the product serial number on page (i) of the User Guide, as you will need the serial number to request service should there be a service need.
- Install the wall mount plate to the LCD TV using screws **NO LONGER than 10mm**, as longer screws found in universal (non-ViewSonic) wall mount kits may damage the power supply causing the unit to fail. The wall-mount screw type is M4 x L10.



- Mount the wall mount bracket to the wall ensuring use of proper screws to support the installation. Ensure there is at least 3cm of space surrounding any air-vents of your LCD TV to allow adequate cooling during operation.
- Hang the LCD TV wall mount plate to the wall mount bracket, completing installation. Enjoy your ViewSonic LCD TV!

Getting Started

Wall Mount Kit Specifications (VESA)

When attaching to other building materials, please contact your nearest dealer.

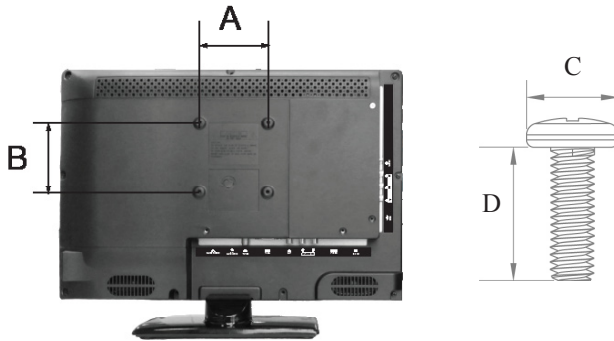

Product Family	inch	VESA Spec. (A x B)	Standard Screw (C x D)	Quantity
LCD TV	16	75 x 75 mm	M4 x L10	4
	19 ~ 24	100 x 100 mm	M4 x L10	4
	26 ~ 27	200 x 100 mm	M4 x L10	4
	32 ~ 37	400 x 100 mm	M6 x L10	4
	42 ~ 47	600 x 200 mm	M6 x L10	4
	52	400 x 200 mm	M6 x L10	4

- ViewSonic provides the standard dimensions for wall mount kits as shown in the table above.
- To find the perfect mount, please browse www.viewsonic.com or call our service team: United States 1-800-688-6688, Canada 1-866-463-4775.
- When purchasing our wall mount kit, a detailed install manual and all parts necessary for assembly are provided.
- Do not use the screws that longer than the standard dimension, as they may cause damage to the inside of the TV set.

Front View of the Product

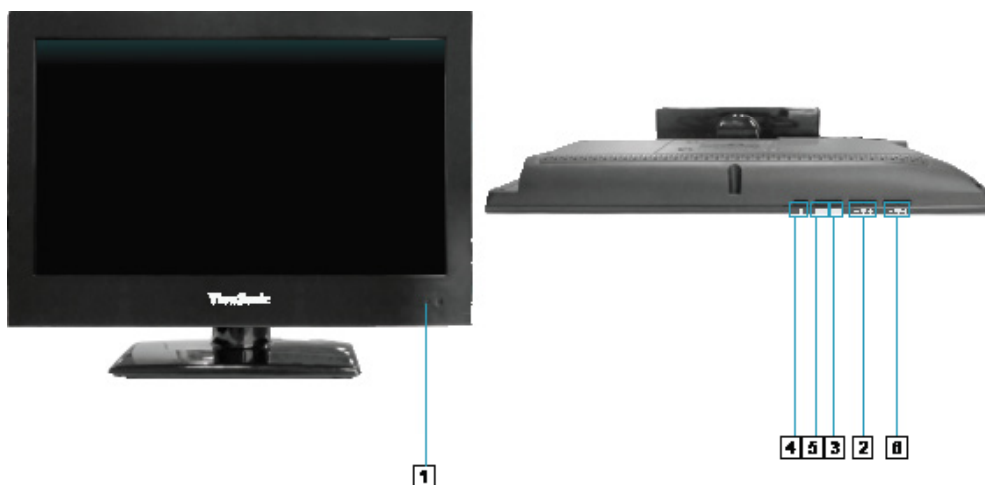

Item	Description
1 Power LED Indicator	Lights up in blue when the TV is turned on. Lights up in orange when the TV is in standby mode.
2 CH Up / Down	Channel up / down when source is TV, or select a control while in OSD menu.
3 MENU	Turn OSD menu ON/OFF.
4 Power ON/OFF button	Turn the power on from standby mode or turn the power off to return to the standby mode.
5 INPUT	Select input source.
6 Volume Up / Down	Increase / Decrease sound volume or adjust a highlighted control while in OSD menu.

Rear View of the Product

ENGLISH

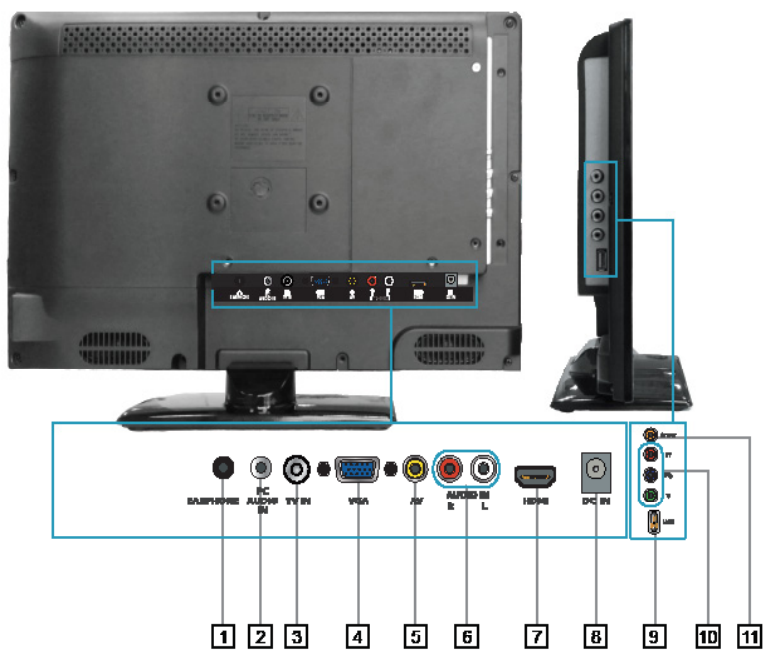

Item	Description
1 EARPHONE	Connect to your headphones. By connecting the headphones, you can listen to the sound from the TV on headphones. * If you connect the headphones, the TV speakers will be muted.
2 PC Audio input	Connect the RGB Audio Out on your computer to the RGB Audio on the rear of the LCD TV.
3 TV Input Jack	Connect this jack to your Cable or VHF/UHF antenna.
4 VGA signal input	Connect a 15-pin D-sub RGB cable to the RGB output of your computer and the other end to the RGB input on the rear of the LCD TV.
5 Composite Video input	Connect this jack to the composite video output connectors on your A/V equipment.
6 AV Audio input (left/ right)	Connect the Audio in cable for AV from this jack to the corresponding connectors on your A/V device.
7 HDMI Input Terminal	Connect this port to the HDMI output of A/V device.
8 Power(DC input)	Plug-in the supplied DC Power cord and connect to the DC input power source.
9 USB	Connect to your USB devices, such as USB flash drive.
10 YPbPr signal input	Connect this port to the YPbPr output of A/V device.
11 SPDIF Optical output	Connect this port to the SPDIF input of A/V device.

Getting Started

Connecting the LCD TV

Cable System or VHF/UHF Antenna System

Enjoy the high-definition and standard-definition digital programming along with standard-definition analog programming.



- This TV is capable of receiving unscrambled digital programming for both cable and external VHF/UHF antenna.
- We strongly recommend that you connect the antenna/cable input using a 75-ohm coaxial cable (not supplied) to ensure the best picture quality.

Cable or VHF/UHF



Cable System and VHF/UHF Antenna System

Use an optional A-B RF switch (not supplied) to switch between the cable and antenna programming, as shown below.

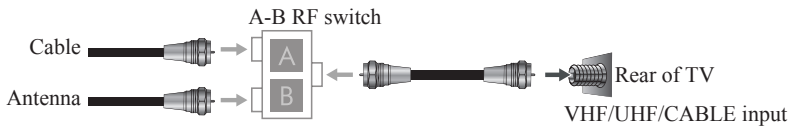

- Remember to set the TV/CATV setting in the TV menu to Air or Cable for the type you choose.

HD Cable Box/HD Satellite Box

You can also enjoy high-definition programming by subscribing to a high-definition cable service or a high-definition satellite service. For the optimum picture quality, be sure to connect this device to your TV via the HDMI or component video (with audio) input on the back of your LCD TV.

HDMI Connection

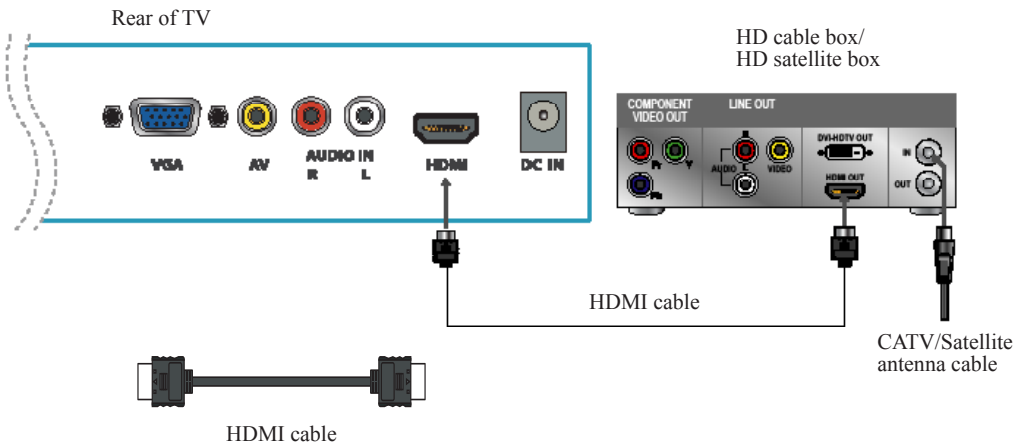

Getting Started

ENGLISH

YPbPr or Component Connection

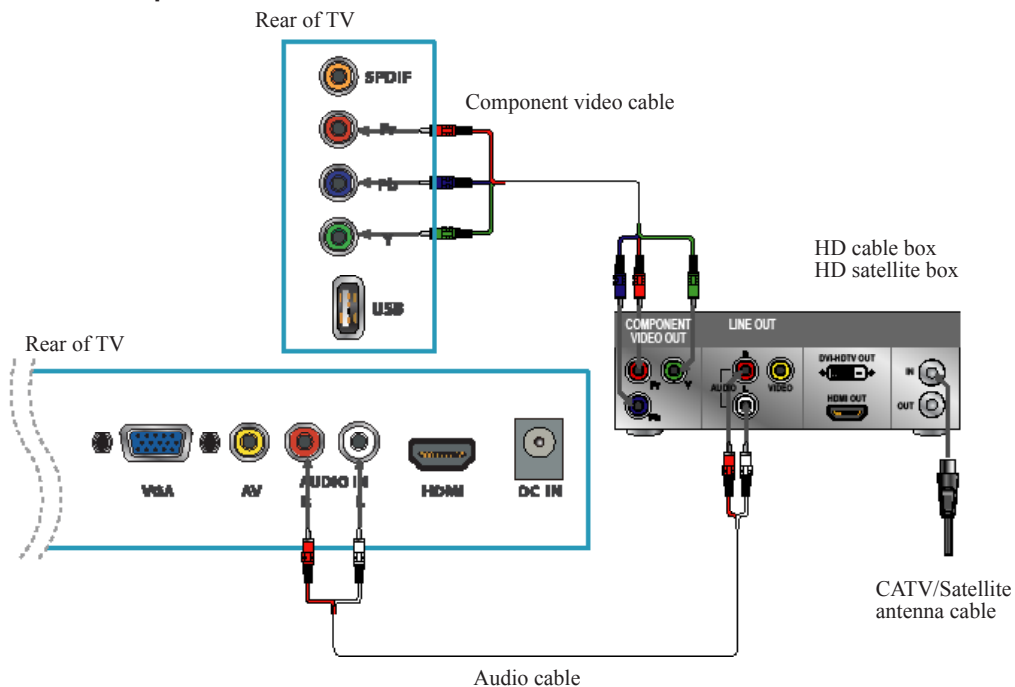

- YPbPr provides better picture quality than the S-Video or the AV connection.

Programming your Cable or Satellite Box remote

Refer the user manual from your service provider to determine the setting.

If it requires:

- 3 digits, please try “566”, “565”, “556”, or “688”. It usually works with DISHNetwork.
- 4 digits, please try “0054”. It usually works with Cox.
- 5-digits, please try “11454”, “11054”, or “10690”. It usually works with DIRECTV.

SD DVD Player

AV or S-Video Connection

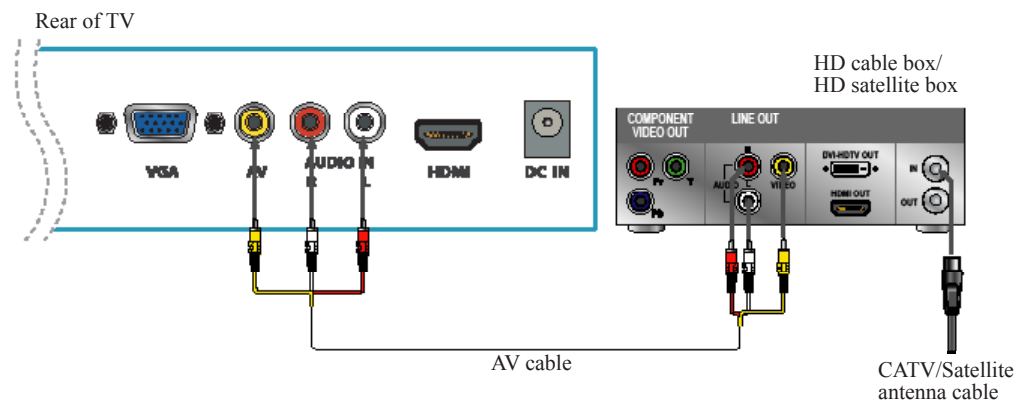

Getting Started

Personal Computer

Use the LCD TV as the monitor of your computer.

The picture below shows the connection for PC. The LCD TV can also be connected to PC with DVI or VGA output.

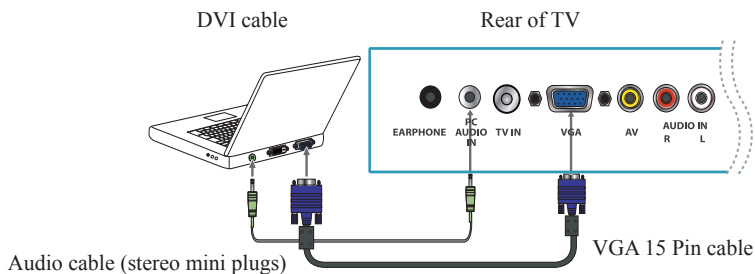

- Connect the PC IN jack to the PC using a 15-pin cable and audio cable.
- If the PC is connected to TV and no signal has been input from PC for more than 15 seconds, the TV will enter standby mode automatically.

PC Timing Reference Chart

<i>Mode</i>		<i>Aspect Ratio Handling</i>	<i>Compatible Input</i>
<i>Standard</i>	<i>Resolution</i>	<i>FS*Full-Screen</i>	<i>RGB</i>
IBM	720 x 400 @ 70Hz	1366x768	Yes
VESA	640 x 480 @ 60Hz	1366x768	Yes
VESA	800 x 600 @ 56Hz	1366x768	Yes
VESA	800 x 600 @ 60Hz	1366x768	Yes
VESA	1024 x 768 @ 60Hz	1366x768	Yes
VESA	1024 x 768 @ 70Hz	1366x768	Yes
VESA	1280 x 1024 @ 60Hz	1366x768	Yes
VESA	1360x 768 @ 60Hz	1366x768	Yes
VESA	1280 x 960 @ 60Hz	1366x768	Yes
VESA	1280 x 768 @ 60Hz	1366x768	Yes



- This TV's PC VGA input does not support interlaced signals.
- For the best picture quality, we recommend that you use the signals (boldfaced) in the above chart with a 60 Hz vertical frequency from a personal computer.
- Preset Timing Mode (Pre-adjusted to GTF® 1366 x 768 @ 60 Hz)

Using the TV Features

Remote Control and TV Controls

ENGLISH

Inserting Remote Control Batteries

1. Remove the battery cover by pulling then lifting the knob on the cover.
2. Insert the batteries, corresponding to the (+) and (-) markings on the battery compartment.
3. Reattach the battery cover.



CAUTION

- Only use the specified AAA batteries.
- Do not mix new and old batteries. This may result in creaking or leakage, which may pose a risk of fire or lead to personal injury.
- Insert batteries according to (+) and (-) markings. Inserting the batteries incorrectly may result in leakage, which may pose a risk of fire or lead to personal injury.
- Dispose of the battery in accordance with local laws and regulations.
- Keep the batteries away from children or pets.
- When the remote control will not be used for an extended period, remove the batteries.

Remote Control and TV Controls

Buttons located at the side of the LCD TV will operate the same as these buttons on the remote control.

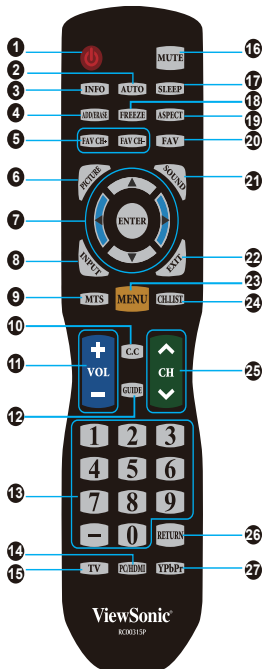

Button	Description
1 POWER	Press this button to turn the power on from standby mode. Press it again to return to the standby mode.
2 AUTO	PC source press this button to auto picture position.
3 INFO	Press this button to display the current state of the LCD TV.

Using the TV Features

ENGLISH

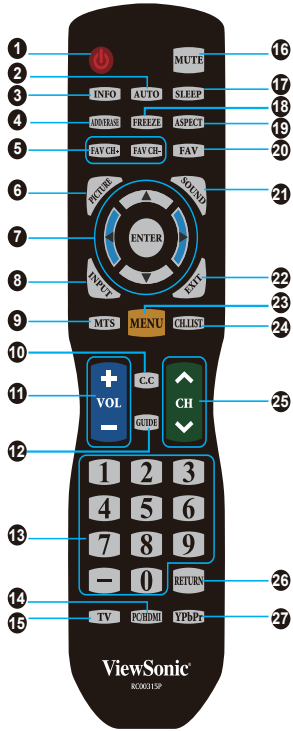

Button	Description
18 FREEZE	Press this button picture will be static.
19 ASPECT	Press this button repeatedly to select the screen size. You can select from Normal, wide, cinema, zoom, full 100% (above 720p timing).
20 FAV	Press this button to show Favorite List and select your favorite channels that have already been stored. * To preset favorite channels, use the Favorite item in the Channel menu.
21 SOUND	Press this button to select between the sound modes of Standard, soft, user, Dynamic.
22 EXIT	OSD exit.
23 MENU	Press to turn the OSD (On-Screen Display) menu on.
24 CH-LIST	Press to display channel list.
25 ▼ CH ▲	Press to change the channels up or down.
26 RETURN	Press to return to previous channel.
27 YPbPr	Press to change source to YPbPr.

Operation

Turning the TV On and Off

Press the **POWER** button on the remote control.

You can also use the Power button on the side of the panel.

* If there is no input signal within 15 minutes, TV will be turned off automatically.

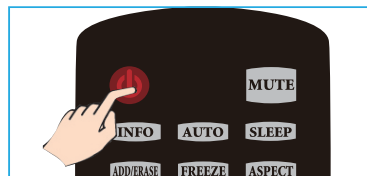

Initial Setup

(Setup Wizard only appears when first turning the TV on and without channel scanning.)

1. Press the **POWER** button on the remote control. The Setup Wizard window will be display.
2. Press **▲** or **▼** to select Home or Retail(See Figure1).
3. Press **◀** or **▶** to select OSD language, then press **ENTER** to confirm the selection, and press **▼** to go to next step. To return to the previous page, press **MENU**.(See Figure2)
4. Select TV Source from Air or Cable, then press **ENTER** to continue.
5. The Initial Setup will be completed after Cannel scanning is finished. To interrupt the scanning, press **MENU** at any time. (See Figure3)

Figure 1

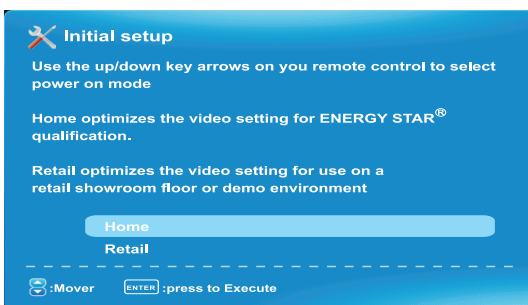

Figure 2

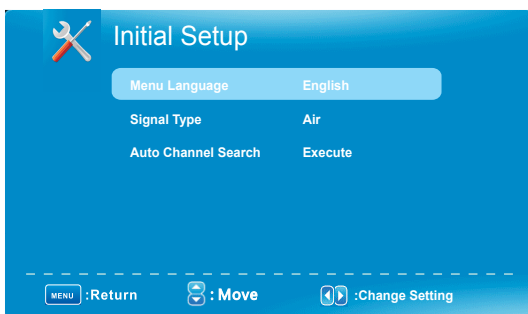
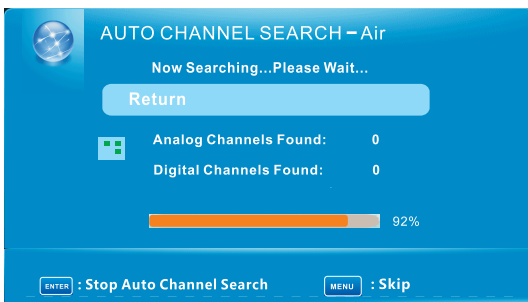

Figure 3



Using the TV Features

Changing Channels

1. Using Channel Buttons

Press **▼CH▲** button to change channels, and the TV changes channels in sequence. You will see all channels that have been memorized. Channels erased or not memorized will not be shown.

2. Using Number Buttons

(1) ATV

The “-” button has no function in ATV mode. Directly press the number buttons to select channels.

(2) DTV

Use “-” button to select the sub channel in DTV.

Ex: Your desired number is 80-3.

Press **8** → press **0** → press “-” → press **3**.

* Return to the previous channel, press **RETURN** button.

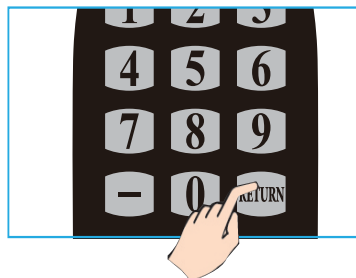

Adjusting the Volume

Press **VOL +/-** to adjust volume.

To turn off the volume, press **MUTE**.

To restore volume, press **MUTE** again, or press **VOL +/-** directly.

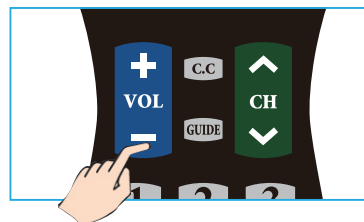

Viewing the Displayed Information

To display the current information of the LCD TV:

Press **INFO**, and the current state will be displayed on the screen. (It shows all or some of the information about Input, Channel, Resolution, Audio Type, etc., depending on what input source it is in)

* The picture here shows an example of the INFO screen in a DTV source.

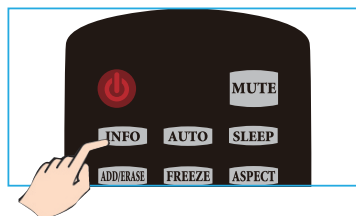

Using the TV Features

Storing Channels into Memory

1. Press the **MENU** button to display the OSD main menu.
2. Press **◀** or **▶** to select the “CHANNEL” menu, then press **ENTER** to enter the menu. Press **▲** or **▼** to select “Signal Type”, and use **◀** or **▶** to select the antenna connection to “Air” or “Cable”.
Air: RF signal programs by “Air”.
Cable: RF signal programs by “Cable”.
3. Press **▲** or **▼** to select “Auto Scan”, then press **▶** to enter.
4. The Auto Scan screen will be shown, and after it is done, the screen will return to the first found channel.

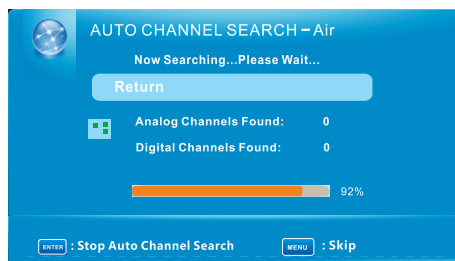
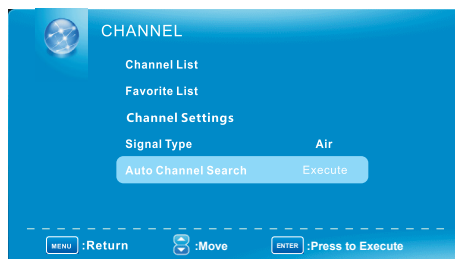
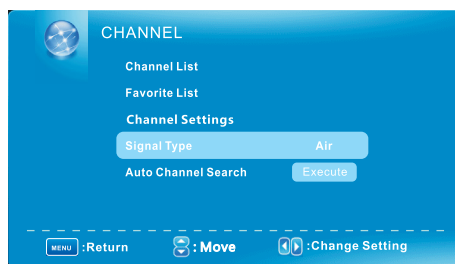

Selecting the Input Source

To select the TV or other external input sources connected to the TV.

1. Press the **INPUT** button on the remote control.
2. Press **▲** or **▼** to select the required input source between TV, AV, YPbPr, HDMI, PC or Media.
(When in USB input source, the system only supports JPEG and MP3 image files.)
3. To confirm the selection, press **ENTER**.



Using the TV Features

Favorite Channel Setting

To set your favorite channel into memory:

1. Press the **MENU** button to display the OSD main menu.
2. Press **◀** or **▶** to select the “CHANNEL” menu, then press **ENTER** to enter the menu. Press **▲** or **▼** to select “Channel settings”, then press **▶** button to enter “Channel settings” setting.
3. Press **▲** or **▼** to select the channel you'd like to be your favorite channel.
Press **ENTER** to confirm your selection.
4. To cancel the selection, Press **ENTER** again on the selected channel.
5. Press **MENU** to exit.

* To view your favorite channels, press **FAV** button to show Favorite List and select your favorite channels that have already been stored.

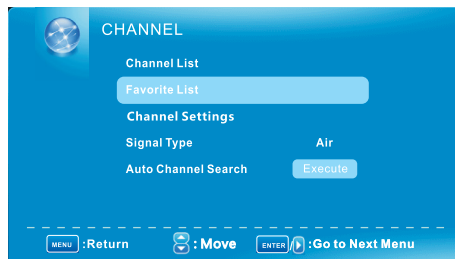
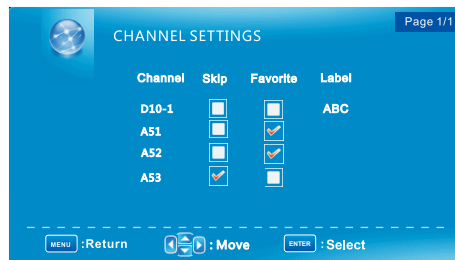

Adding/Erasing Channel

When the channel is erased, it will not appear on the screen when you browse the channels with **▼CH▲** button. To see the channel again, you must add the channel or perform the “Auto Scan” function again.

1. Press the **MENU** button to display the OSD main menu.
2. Press **◀** or **▶** to select the “CHANNEL” menu, then press **ENTER** or **▼** to enter the menu. Press **▲** or **▼** to select “Show/Hide”, then press **▶** button to enter “Show/Hide” setting.
3. Press **▲** or **▼** to select the channel you want to Show/Hide, and check or uncheck it with **ENTER** button.
4. Press **MENU** to exit.

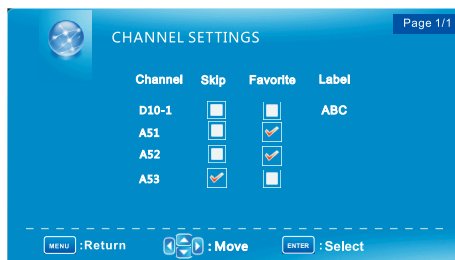
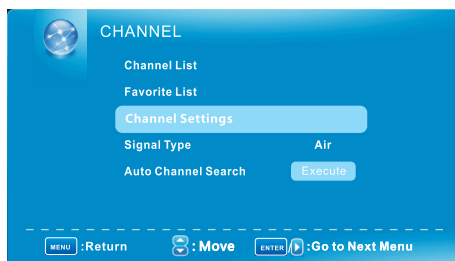

Using the TV Features

Channel Name Setting

To edit a name for the current channel:

1. Press the **MENU** button to display the OSD main menu.
2. Press ◀ or ▶ to select the “CHANNEL” menu, then press **ENTER** or ▼ to enter the menu.
3. Press ▲ or ▼ to select “Channel Settings.”, then press ◀ or ▶ to select the channel you want to edit the name.
4. Press ▲ or ▼ to select “Channel Label”, then press ▶ button to enter “Channel Label” setting.
5. Use ▲ or ▼ to choose letters or signs, ◀ or ▶ to move forward or backward.
6. After you input the channel name, press **MENU** or **ENTER** to complete the setting.
7. Press **MENU** to exit.

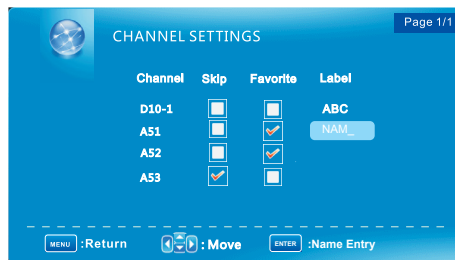
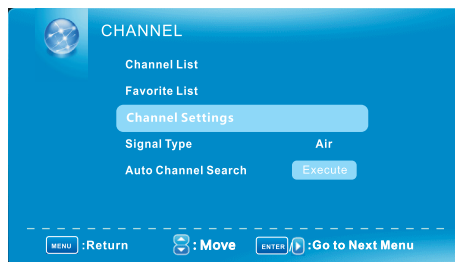

Using the Parent Controls

1. Press the **MENU** button to display the OSD main menu.
2. Press ◀ or ▶ to select the “Parent” menu.
3. Press **ENTER** to enter Password.
4. Enter the password. (The default password is 0000)
5. Move to “V-CHIP”, and select “On” to enable the detailed settings.
6. Move to “US” or “Canada” rating system.

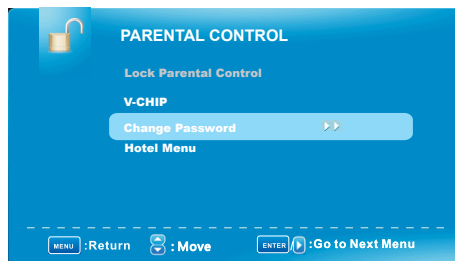
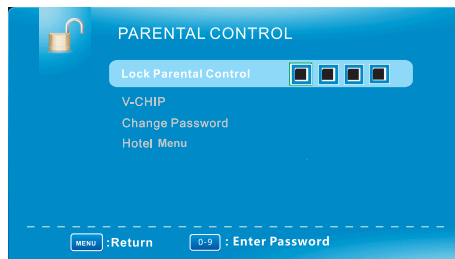

Using the TV Features

US: Press ► to set TV or Movie ratings.

(1) Movie

1. Press ▲ or ▼ to select “Movie”, then press ► to enter “Movie” rating system setting.
2. Press ▲ or ▼ to select your desired Movie ratings level.

The Movie ratings level are defined as following:

G (general audience)

PG (parental guidance suggested)

PG-13 (recommended for children 14 years of age or older)

R (mature audience)

NC-17 (no one under 17 years of age)

X (adult audience only)

N/A (not applicable)

3. Press ▲/▼ to set or reset each area.
4. Press **MENU** to exit.

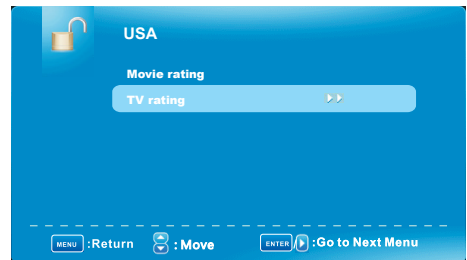
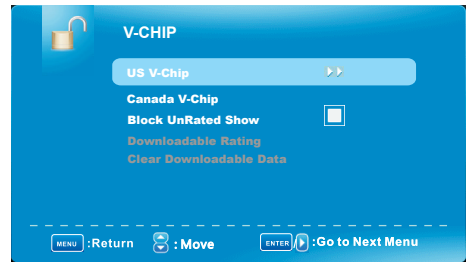

(2) TV

1. Press ▲ or ▼ to select “TV”, then press ► to enter “TV” rating system setting.
2. Press ▲ or ▼ to select your desired TV ratings level.

The following screen will allow you to customize the following TV ratings:

TV-Y (all children)

TV-Y7 (older children)

TV-G (general audience)

TV-PG (guidance suggested)

TV-14 (strongly cautioned)

TV-MA (mature audience)

You can also customize the TV ratings for the following content:

ALL (All types content)

FV (fantasy violence)

V (violence)

S (sexual situations)

L (adult language)

D (sexual dialog)

3. Press **ENTER** to set or reset each area.
4. Press **MENU** to exit.

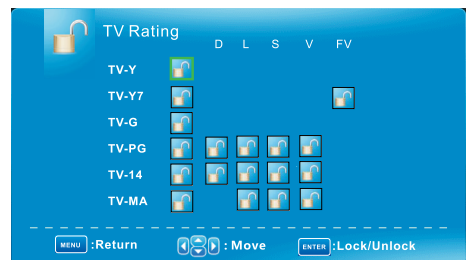

Using the TV Features

Canada: Press ► to set Canadian English and French ratings.

(1) Canadian English

1. Press ▲ or ▼ to select “English rating”.
2. Press ► to enter.
3. Press ▲ or ▼ to select your desired Canadian English rating level.

The Canadian English rating levels are defined as following:

C (children)

C8+ (children eight years and older)

G (general programming, suitable for all audiences)

PG (parental guidance)

14+ (viewers and older)

18+ (adult programming)

EXEMPT (exempt)

4. Press ▲/▼ to set or reset each area.
5. Press **MENU** to exit.



(2) Canadian French

1. Press ▲ or ▼ to select “French rating”.
2. Press ► to enter.
3. Press ▲ or ▼ to select your desired Canadian French rating level.

The Canadian French rating levels are defined as following:

G (general)

8ans+ (children eight years and older)

13ans+ (not appropriate for children of less than 13 years)

16ans+ (not appropriate for children of less than 16 years)

18ans+ (reserved to adults)

EXEMPT (exempt)

4. Press ▲/▼ to set or reset each area.
5. Press **MENU** to exit.

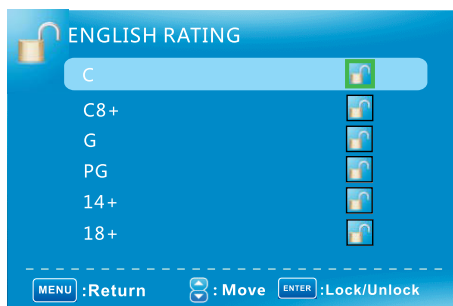

To Block Unrated Movie or TV Programs

1. Press ▲ or ▼ to select “Unrated Lock”, then press ◀ or ▶ to select “On” or “Off”. When “On” is selected, all programs that are not rated will be blocked.
2. Press **MENU** to exit.

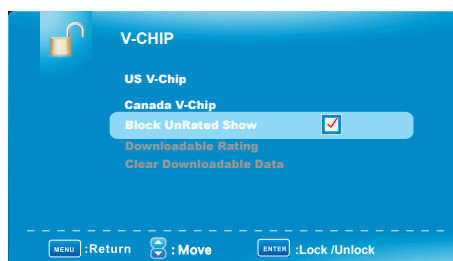

Using the TV Features

To Change Password

1. Press **▲** or **▼** to select “Change Password”, then press **▶** to enter “Change Password” setting.
2. Move to “Enter Old Password”, then enter the old password with number keys.
3. Enter your new password on “Enter New Password”.
4. Enter your new password again on “Confirm Password”.

After you complete the last step, the screen will return to the top page of LOCK menu. If so, the password has been changed successfully.

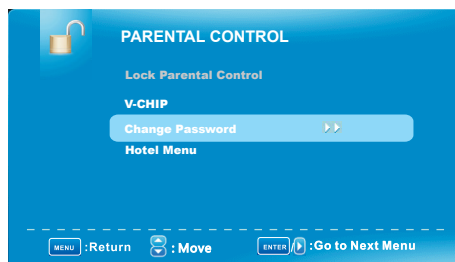

To Restore Factory Setting

1. Press the **MENU** button to display the OSD main menu.
2. Press **◀** or **▶** to select the “OTHERS” menu.
3. Press **ENTER** or **▼** to enter “OTHERS” menu.
4. Press **▲** or **▼** to select “Restore Default”, then press **▶** to restore the factory default setting.
5. Select “Yes” and press **ENTER** to confirm the setting.



Using PC Function

1. When in PC source, press the **MENU** button to display the OSD main menu.
2. Press **◀** or **▶** to select the “PICTURE” menu, then press **ENTER** or **▼** to enter the menu.
3. Press **▲** or **▼** to select your desired controls, and press **◀** or **▶** to adjust.
4. For PC settings, select “PC settings” (only in PC source) and press **▶** to enter.
5. Press **▲** or **▼** to select “H-Pos” (H-Position), “V-Pos” (V-Position), “Clock”, “Phase” or “Auto” (Auto adjustment), and adjust the level with **◀** or **▶**.

* When in PC source, the other menus are the same as or similar to when in other source.

* When there is no signal in the PC mode, “No Signal” will be displayed on the screen and the TV will automatically turn into power-saving mode after 15 seconds' idleness.

Press **POWER** button on the remote control and the TV will return to VGA mode.

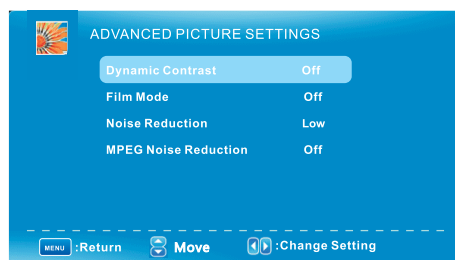
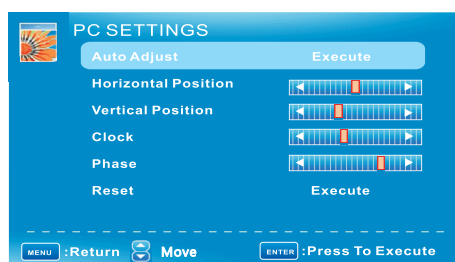
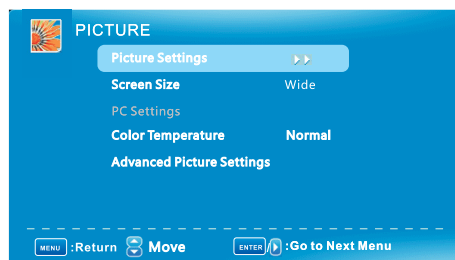

Using the TV Features

Using USB Function

When input source is selected to USB, insert the USB device into the USB jack. USB only supports JPEG and MP3 files.

Viewing Photo or Slide Show

1. Use ◀ or ▶ to select “Photo”.
2. Use ▲ or ▼ to select the folder you want, and press **ENTER**.
3. Return to main menu, press ▲ or ▼ to ”--“ and press **ENTER**. Use ▲ or ▼ to select the image files (With ♥ symbol) you want, and press **ENTER** to play.

In Photo function, you can use the buttons to make following functions:

Press **INFO** can view all of the functions

- * Press **EXIT** go back to the previous page.
- * Use ◀ or ▶ to display the next or previous picture.
- * Use ▲ or ▼ to rotate right or rotate left the picture. (Only available in X1.0 mode)
- * Press **Aspect** to zoom in. (X1.5~X4.0)
- * When the Aspect Ratio, press ▲▼◀▶ to move.
- * Press **ENTER** to auto-play or stop the pictures.

In “Option” menu can setup following functions:

1. Press the **MENU** button to display the OSD main menu.
2. Press ◀ or ▶ to select “Option” menu, then press **ENTER** or ▼ to enter the menu. Press ▲ or ▼ to select “Media”, and use ▶ to enter “Media” setting.

•Slide Show Timer:

To select the pictures auto-play interval time.

•Trans. Effect:

To select the auto-play effects of the slide show.

•File List Sorting:

To select the pictures arrange.

•Slide Show Repeat:

To select the slide show repeat to On or Off.

Playing the Music

1. Use ◀ or ▶ to select “Music”.
2. Use ▲ or ▼ to select the folder you want, and press **ENTER**.
3. Return to main menu, press ▲ or ▼ to ”--“ and press **ENTER**. Use ▲ or ▼ to select the MP3 files (With ♥ symbol) you want, and press **ENTER** to play.
4. In Music function, press ▼ to use all of the functions to control.

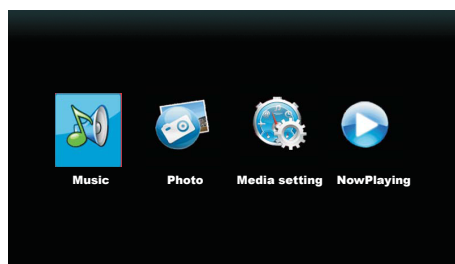

Name	IMG_031
Size	2592X1944
Orientation	1
Date	09/04/2010
Date Time	2010:09:11 11:49:30
Date TimeOriginal	2010:09:11 11:49:30
Date TimeDigitized	2010:09:11 11:49:30
Maker	Canon
Model	Canon SX1

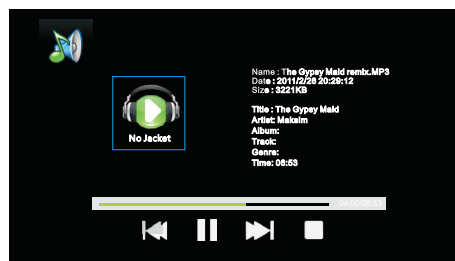

Using the TV Features

Adjusting the Settings

1. Press the **MENU** button to display the OSD main menu. There are six top menus on the screen: PICTURE, SOUND, CHANNEL, PARENTAL, SETUP, and OTHERS. (CHANNEL menu can only be enabled in TV source.)
2. Press ◀ or ▶ to select your desired top menu.
3. Press **ENTER** to enter the menu you select.
4. Use ▲▼ to select the control you want to adjust.
5. When selecting the control with ▶, press ▶ to enter next level menu or enable the function. (▶ will only appear when the control is highlighted)
6. Press ◀▶ to adjust or select the settings.
7. Press **MENU** to exit from the OSD menu.

Picture menu

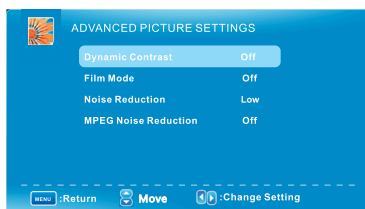
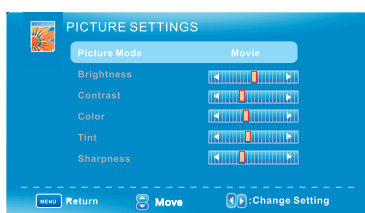

Function	Description
Picture Mode	To select picture mode.
Brightness	To adjust luminance of video.
Contrast	To adjust contrast of video.
Color	To adjust color.(Except PC source)
Tint	To adjust tint level.(Except PC source)
Sharpness	To adjust picture sharpness.
Screen Size	To select image size between Normal,Wide,Cinema,Zoom. To fine tune the image.(Only enabled in PC source) * Auto Adjust: To auto adjust picture's horizontal position, vertical position, clock, phase, fine tune and H-Size. * Horizontal Position: To adjust the horizontal position of the picture. * Vertical Position: To adjust the vertical position of the picture. * Clock: To adjust delay time of clock in order to reduce the noise of picture. * Phase: To adjust delay time of phase in order to reduce the noise of picture. * Reset: Reset the parameters of current menu to default value.
Color Temperature	To select and adjust color mode. * Dynamic Contrast: Off/Low/Medium/High The system will adjust the luminance curve by analyzing the picture content dynamically. * Film Mode: Off/On For the 2:2 or 3:2 format signal of cinema,enable special pixel process to reduce the flick of moving area. * Noise Reduction: Off/Low/Medium/High You can clear up analog TV signal by reducing the dot noise.This feature is not available at PC or Media source. * MPEG Noise Reduction: Off/Low/Medium/High Similar with the Noise Reduction ,you can set to reduce the block noise.
PC Settings	
Advanced Picture Settings	

Using the TV Features

Audio menu

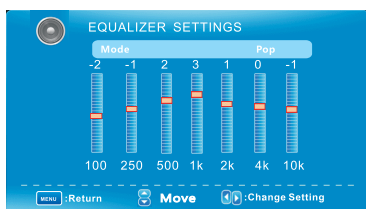
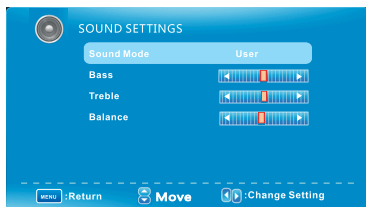
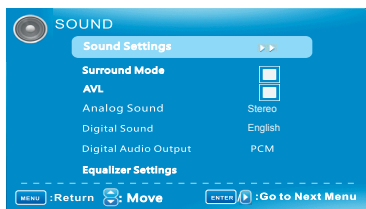

Function	Description
Sound Mode	To select Sound modes
Bass	To adjust bass.
Treble	To adjust the treble.
Balance	To adjust left and right audio balance.
AVL	To turn on/off AVL (automatic volume limited) function. Press ENTER to set or cancel.
Analog Sound	Available at analog TV channels. <i>SAP/Stereo/Mono.</i>
Digital Sound	Available at digital TV channels. <i>English/French/Spanish.</i>
Digital Audio Output	Set the audio output type of coax or optical terminal. <i>PCM/Raw/Off.</i>
Equalizer Settings	Adjust the curve of 7 bands equalizer.

Channel menu (Only available in TV source)

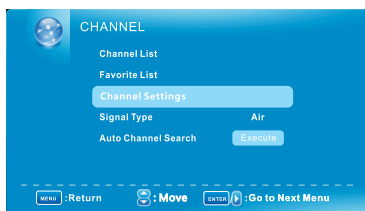

Function	Description
Channel List	You can view all the channels and choose one quickly.
Favorite List	All of your favorite channels are listed in this menu, and you can choose them quickly. Set the favorite channels, skipped channels, label of channels.
Channel Setting	<ul style="list-style-type: none"> * Skip: Set the channel to be skipped when using CH+/ CH- to view channels. * Favorite: Set the channel to your favorite list. * Label: rename label of the channel.
Signal Type	Set to Air or Cable according to your antenna source.
Auto Channel Search	Highlight and press ENTER to start the auto searching.

Using the TV Features

Lock menu

ENGLISH

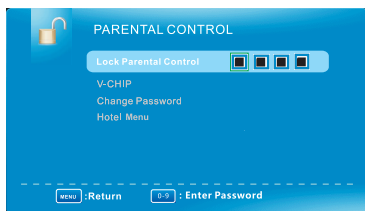

Function	Description
Lock Parental Control	The following items are only available if the password input is correct. Note: The default user password is “0000”, and if forget what you set, try “1470”.
V-CHIP	Include below settings: <ul style="list-style-type: none"> * US V-Chip: Rating system used at USA. * Canada V-Chip: Rating system used at Canada. * Block UnRated Show: Control whether lock the program that have not any valid rating flag. * Downloadable Rating: Control the RRT5 setting which are valid only at some digital cable channels. * Clear Downloadable Data: Select to clear the previous downloadable rating data.
Change Password	Enter a 4-digital number you want to set.
Hotel Menu:	Boot Setting/Hotel Lock Setting/Power Save/Export Setting/Import Setting/ Reset Hotel Setting.

Setup menu

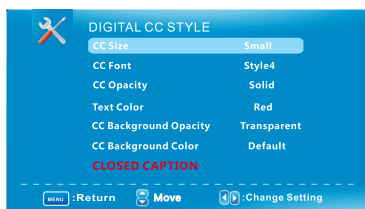

Function	Description
Closed Caption	To set close caption options. (Only available in TV, AV source) <ul style="list-style-type: none"> * Caption Display: Display or hide the CC. * Analog Caption Type: Select from below closed-caption modes for analog programs. (<i>CC1~CC4, TEXT1~TEXT4</i>) * Digital Caption Type: Applies only to digital channels with closed caption. <i>Service 1, 2, 3, 4, 5, 6.</i> * Digital CC Preset: <i>Default/Custom</i> If set to Custom, Digital CC Style is available. * Digital CC Style
Menu Language	To select OSD language. <i>English/Français/Español.</i>
Clock	Set the Time Zone/Auto Clock/Setup Time/Day of week/Daylight Saving Time.

Using the TV Features

Time menu (Except USB source)



Function	Description
Time Zone	To select the time zone appropriate to your location.
Auto Clock	To turn on/off Auto Sync.
Setup Time	Set Auto Clock to off, then you can set the time manually. Note: In the case of loss of power, the clock setting will be lost.
Day of Week	The TV will calculate current day of week according to the time.
Daylight Saving Time	Set summer time yes or not

Others

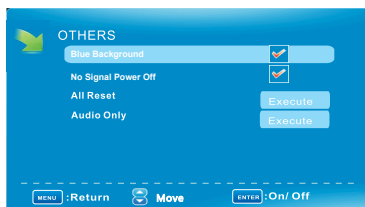

Function	Description
Blue Background	Set the screen background color blue or not when no valid signal input.
No Signal Power Off	If it is set, TV will automatically enter standby after 15 minutes without signal input.
All Reset	TV system is reset.
Audio only	Hold on power key 3 second to restore video.

Other Information

Troubleshooting

Please contact ViewSonic service team directly if you have questions, service needs, or require technical assistance related on the use of your television.

Contact ViewSonic Service Team at:

<http://www.ViewSonic.com>

Or call our service team:

United States 1-800-688-6688

Canada 1-866-463-4775

Problem	Possible Solution
No power	<ul style="list-style-type: none">• Make sure the power cord is properly connected to the LCD TV AC power socket.• Make sure the AC power cord is properly connected to the wall outlet.• Make sure the DC power button is ON (Blue LED).• Plug another electrical device (like a radio) to the power outlet to verify that the outlet is supplying the proper voltage.
No picture	<ul style="list-style-type: none">• The TV station may be experiencing problems. Try another channel.• The Cable TV signal may be scrambled or encoded. Please contact your local cable operator.• Make sure that connection to other components are correct referring to the user guide.• Make sure that setup has been done correctly after connections.• Make sure the correct input is selected and the input signal is compatible.
Strange color, light color, or color misalignment	<ul style="list-style-type: none">• Ensure that the video cable is securely connected.• The picture may appear dim in a brightly lit room.• Adjust brightness, contrast, saturation (color), and tint referring to the user guide.• Check the input signal setting.
No sound	<ul style="list-style-type: none">• Check your audio connections are properly connected referring to the user guide.• The MUTE button may have been pressed, try pressing this button again.• Check your audio settings, your TV audio may be set to minimum.• Press the Volume + (Up) button on the remote control.

Other Information

Problem	Possible Solution
Remote control unit does not operate	<ul style="list-style-type: none">• Make sure the directions of batteries are inserted correctly referring to the user guide.• Batteries could be weak or dead. Replace with new batteries.• Is a fluorescent light illuminated near the remote control sensor?• The path of the remote control beam may be blocked. Make sure the path is clear and that the remote control is aimed at the remote control sensor on the TV.• Press the POWER button on the remote control to see if you can turn on the TV.• Press MENU button on the remote control to see if there is a MENU shown on the screen.• Press only one button at a time and it is the correct one for the operation you want to perform.
Unit cannot be operated	<ul style="list-style-type: none">• External influences such as lightning or static electricity may cause improper operation. In this case, operate the unit after first turning on the power of the LCD TV and the AVC System, or unplug the AC cord for 1 to 2 minutes, then replug again.
Power is cut off suddenly	<ul style="list-style-type: none">• Is the sleep timer set in advance?• Is there no signal in PC mode or HDMI mode?• The internal temperature of the unit has increased. Remove any objects blocking the vent or clean as necessary.
No CATV reception (or no reception above CH13)	<ul style="list-style-type: none">• Is the AIR/CABLE option set correctly? Please set the AIR/CABLE option to CABLE referring to the user guide.• CATV is connected improperly or not connected; please check all the CATV connections.• The cable TV service is interrupted; please contact your cable operator.
Picture is cut off/with sidebar screen	<ul style="list-style-type: none">• Is the image positioned correctly?• Are screen mode adjustments such as picture size set correctly?• Press WIDE button repeatedly on the remote control to see if you can get the picture you prefer.

Other Information

Specifications

Model		VT1601LED
LCD (LED Backlight)	Type	16" TFT Active Matrix RGB 0.252(H) x 0.252(V) mm pixel
	Color Pixel Arrangement	RGB vertical strip
	Surface Treatment	AG type, 3H hard coating, Haze 25
Input signal	RGB	RGB analog (0.7/1.0 Vp-p, 75 ohms) Separate Sync, f _h : 30-82 kHz, f _v :55-76 Hz
	RF	TV system Antenna / NTSC+ATSC, TV cable system / CATV+Digital cable
	Video	1 composite RCA, 1 YPbPr component, 1 HDMI
	Audio	1 pair of RCA (L/R) stereo
	USB	JPEG / MP3 Format
Compatibility	PC	Up to 1366 x768 @ 60 Hz, 1 VGA mode,
Resolution	Recommended and supported (VGA mode)	720*400@70Hz (IBM) 640*480@60Hz (VESA) 800*600@56Hz (VESA) 800*600@60Hz (VESA) 1024*768@60Hz (VESA) 1024*768@70Hz (VESA) 1280*1024@60Hz (VESA) 1360*768@60Hz (VESA) 1280* 960 @60Hz (VESA) 1280*768 @60Hz (VESA)
Speaker Output		2.5W x 2 @ THD=10%
Audio Output		1 Headphone jack, 1 SPDIF (optical)
Power	Voltage	100V/60Hz-264V/50Hz (auto switch)
Display area	Full Scan	344.232mm (H) x 193.536mm (V) 13.55" (H) x 7.62" (V)
Operating conditions	Temperature	32°F to + 104°F (0°C to + 40°C)
	Humidity	20% to 80% (no condensation)
	Altitude	0 To 6,500 feet (2,000m)
Storage condition	Temperature	-4°F to + 140°F (-20°C to + 60°C)
	Humidity	5% to 90% (no condensation)
	Altitude	0 To 12,000 feet (3,790.3m)
Dimensions	Physical	392.1mm x 291.7mm x 120.00mm
	(W) x (H) x (D)	15.44" x 11.48" x 4.72"
Weight	Net	1.5 kg (3.3 lb)
Power consumption	On	< 25 W [Max] (blue LED)
	Stand by	< 0.5 W @ 115 Vac only (orange LED)
Warning: Do not set the graphics card in your computer to exceed these refresh rates; doing so may result in permanent damage to the LCD TV.		

Note: Product Specifications are subject to change without notice.

Other Information

Customer Support

For technical support or product service, see the table below or contact your reseller.

Note: You will need the product serial number.

Use with other Wall-Mount kit may cause instability and possibly result in injury.

To find the perfect mount for VT1601LED, please browse www.viewsonic.com or call our service team: United States 1-800-688-6688, Canada 1-866-463-4775.

Country/Region	Website	T = Telephone F = FAX	Email
United States	www.viewsonic.com	T (Toll-Free)= 1-800-688-6688 T (Toll)= 1-424-233-2530 F= 1-909-468-3757	service.us@viewsonic.com
Canada	www.viewsonic.com	T (Toll-Free)= 1-866-463-4775 T (Toll)= 1-424-233-2533 F= 1-909-468-3757	service.ca@viewsonic.com
Latin America (Argentina)	www.viewsonic.com/la/	T= 0800-4441185	soporte@viewsonic.com
Latin America (Chile)	www.viewsonic.com/la/	T= 1230-020-7975	soporte@viewsonic.com
Latin America (Columbia)	www.viewsonic.com/la/	T= 01800-9-157235	soporte@viewsonic.com
Latin America (Mexico)	www.viewsonic.com/la/	T= 001-8882328722	soporte@viewsonic.com
Renta y Datos, 29 SUR 721, COL. LA PAZ, 72160 PUEBLA, PUE. Tel: 01.222.891.55.77 CON 10 LINEAS Electroser, Av Reforma No. 403Gx39 y 41, 97000 Mérida, Yucatán. Tel: 01.999.925.19.16 Other places please refer to http://www.viewsonic.com/la/soporte/index.htm#Mexico			
Latin America (Peru)	www.viewsonic.com/la/	T= 0800-54565	soporte@viewsonic.com

Limited Warranty

VIEWSONIC LED TV

What the warranty covers:

ViewSonic warrants its products to be free from defects in material and workmanship, under normal use, during the warranty period. If a product proves to be defective in material or workmanship during the warranty period, ViewSonic will, at its sole option, repair or replace the product with a like product. Replacement product or parts may include remanufactured or refurbished parts or components.

How long the warranty is effective:

ViewSonic LED TVs are warranted for 1 year for all parts excluding the light source and 1 year for labor from the date of the first customer purchase.

Who the warranty protects:

This warranty is valid only for the first consumer purchaser.

What the warranty does not cover:

1. Any product on which the serial number has been defaced, modified or removed.
2. Damage, deterioration or malfunction resulting from:
 - a. Accident, misuse, neglect, fire, water, lightning, or other acts of nature, unauthorized product modification, or failure to follow instructions supplied with the product.
 - b. Repair or attempted repair by anyone not authorized by ViewSonic.
 - c. Any damage of the product due to shipment.
 - d. Removal or installation of the product.
 - e. Causes external to the product, such as electric power fluctuations or failure.
 - f. Use of supplies or parts not meeting ViewSonic's specifications.
 - g. Normal wear and tear.
 - h. Any other cause which does not relate to a product defect.
3. Any product exhibiting a condition commonly known as "image burn-in" which results when a static image is displayed on the product for an extended period of time.
4. Removal, installation, and set-up service charges.
5. When you mount it on the wall, the following must be noticed:
 - a. The accessories attached with this product are applicable for this product only.
 - b. When the product is mounted on the wall, holes and fixed screws will remain in the wall body.
 - c. Wall face may discolor when this product has been mounted on the wall for a long time.

How to get service:

1. For information about receiving service under warranty, contact ViewSonic Customer Support (please refer to Customer Support page). You will need to provide your product's serial number.
2. To obtain warranted service, you will be required to provide (a) the original dated sales slip, (b) your name, (c) your address, (d) a description of the problem, and (e) the serial number of the product.
3. Take or ship the product freight prepaid in the original container to an authorized ViewSonic service center or ViewSonic.
4. For additional information or the name of the nearest ViewSonic service center, contact ViewSonic.

Limitation of implied warranties:

There are no warranties, express or implied, which extend beyond the description contained herein including the implied warranty of merchantability and fitness for a particular purpose.

Exclusion of damages:

ViewSonic's liability is limited to the cost of repair or replacement of the product. ViewSonic shall not be liable for:

1. Damage to other property caused by any defects in the product, damages based upon inconvenience, loss of use of the product, loss of time, loss of profits, loss of business opportunity, loss of goodwill, interference with business relationships, or other commercial loss, even if advised of the possibility of such damages.
2. Any other damages, whether incidental, consequential or otherwise.
3. Any claim against the customer by any other party.

Effect of state law:

This warranty gives you specific legal rights, and you may also have other rights which vary from state to state. Some states do not allow limitations on implied warranties and/or do not allow the exclusion of incidental or consequential damages, so the above limitations and exclusions may not apply to you.

Sales outside the U.S.A. and Canada:

For warranty information and service on ViewSonic products sold outside of the U.S.A. and Canada, contact ViewSonic or your local ViewSonic dealer.

The warranty period for this product in mainland China (Hong Kong, Macao and Taiwan Excluded) is subject to the terms and conditions of the Maintenance Guarantee Card.

For users in Europe and Russia, full details of warranty provided can be found in www.viewsoniceurope.com under Support/Warranty Information.

4.3: ViewSonic LED TV Warranty

LTV_LW01 Rev. 1C 06-25-07

Mexico Limited Warranty

VIEWSONIC LED TV

What the warranty covers:

ViewSonic warrants its products to be free from defects in material and workmanship, under normal use, during the warranty period. If a product proves to be defective in material or workmanship during the warranty period, ViewSonic will, at its sole option, repair or replace the product with a like product. Replacement product or parts may include remanufactured or refurbished parts or components & accessories.

How long the warranty is effective:

ViewSonic LED TVs are warranted for 1 year for all parts excluding the light source and 1 year for labor from the date of the first customer purchase.

Who the warranty protects:

This warranty is valid only for the first consumer purchaser.

What the warranty does not cover:

1. Any product on which the serial number has been defaced, modified or removed.
2. Damage, deterioration or malfunction resulting from:
 - a. Accident, misuse, neglect, fire, water, lightning, or other acts of nature, unauthorized product modification, unauthorized attempted repair, or failure to follow instructions supplied with the product.
 - b. Any damage of the product due to shipment.
 - c. Causes external to the product, such as electrical power fluctuations or failure.
 - d. Use of supplies or parts not meeting ViewSonic’s specifications.
 - e. Normal wear and tear.
 - f. Any other cause which does not relate to a product defect.
3. Any product exhibiting a condition commonly known as “image burn-in” which results when a static image is displayed on the product for an extended period of time.
4. Removal, installation, insurance, and set-up service charges.

How to get service:

For information about receiving service under warranty, contact ViewSonic Customer Support (Please refer to the attached Customer Support page). You will need to provide your product’s serial number, so please record the product information in the space provided below on your purchase for your future use. Please retain your receipt of proof of purchase to support your warranty claim.

For Your Records

Product Name: _____

Model Number: _____

Document Number: _____

Serial Number: _____

Purchase Date: _____

Extended Warranty Purchase? _____ (Y/N)

If so, what date does warranty expire? _____

1. To obtain warranty service, you will be required to provide (a) the original dated sales slip, (b) your name, (c) your address, (d) a description of the problem, and (e) the serial number of the product.
2. Take or ship the product in the original container packaging to an authorized ViewSonic service center.
3. Round trip transportation costs for in-warranty products will be paid by ViewSonic.

Limitation of implied warranties:

There are no warranties, express or implied, which extend beyond the description contained herein including the implied warranty of merchantability and fitness for a particular purpose.

Exclusion of damages:

ViewSonic’s liability is limited to the cost of repair or replacement of the product. ViewSonic shall not be liable for:

1. Damage to other property caused by any defects in the product, damages based upon inconvenience, loss of use of the product, loss of time, loss of profits, loss of business opportunity, loss of goodwill, interference with business relationships, or other commercial loss, even if advised of the possibility of such damages.
2. Any other damages, whether incidental, consequential or otherwise.
3. Any claim against the customer by any other party.
4. Repair or attempted repair by anyone not authorized by ViewSonic.

Other Information

Contact Information for Sales & Authorized Service (Centro Autorizado de Servicio) within Mexico:	
<p>Name, address, of manufacturer and importers: México, Av. de la Palma #8 Piso 2 Despacho 203, Corporativo Interpalmas, Col. San Fernando Huixquilucan, Estado de México Tel: (55) 3605-1099 http://www.viewsonic.com/la/soporte/index.htm</p>	
<p>NÚMERO GRATIS DE ASISTENCIA TÉCNICA PARA TODO MÉXICO: 001.866.823.2004</p>	
<p>Hermosillo: Distribuciones y Servicios Computacionales SA de CV. Calle Juárez 284 local 2 Col. Bugambillas C.P: 83140 Tel: 01-66-22-14-9005 E-Mail: disc2@hmo.megared.net.mx</p>	<p>Villahermosa: Compumantenimientos Garantizados, S.A. de C.V. AV. GREGORIO MENDEZ #1504 COL, FLORIDA C.P. 86040 Tel: 01 (993) 3 52 00 47 / 3522074 / 3 52 20 09 E-Mail: compumantenimientos@prodigy.net.mx</p>
<p>Puebla, Pue. (Matriz): RENTA Y DATOS, S.A. DE C.V. Domicilio: 29 SUR 721 COL. LA PAZ 72160 PUEBLA, PUE. Tel: 01(52).222.891.55.77 CON 10 LINEAS E-Mail: datos@puebla.megared.net.mx</p>	<p>Veracruz, Ver.: CONEXION Y DESARROLLO, S.A DE C.V. Av. Americas # 419 ENTRE PINZÓN Y ALVARADO Fracc. Reforma C.P. 91919 Tel: 01-22-91-00-31-67 E-Mail: gacosta@qplus.com.mx</p>
<p>Chihuahua Soluciones Globales en Computación C. Magisterio # 3321 Col. Magisterial Chihuahua, Chih. Tel: 4136954 E-Mail: Cefeo@soluglobales.com</p>	<p>Cuernavaca Compusupport de Cuernavaca SA de CV Francisco Leyva # 178 Col. Miguel Hidalgo C.P. 62040, Cuernavaca Morelos Tel: 01 777 3180579 / 01 777 3124014 E-Mail: aquevedo@compusupportcva.com</p>
<p>Distrito Federal: QPLUS, S.A. de C.V. Av. Coyoacán 931 Col. Del Valle 03100, México, D.F. Tel: 01(52)55-50-00-27-35 E-Mail : gacosta@qplus.com.mx</p>	<p>Guadalajara, Jal.: SERVICRECE, S.A. de C.V. Av. Niños Héroes # 2281 Col. Arcos Sur, Sector Juárez 44170, Guadalajara, Jalisco Tel: 01(52)33-36-15-15-43 E-Mail: mmiranda@servicrece.com</p>
<p>Guerrero Acapulco GS Computación (Grupo Sesicomp) Progreso #6-A, Colo Centro 39300 Acapulco, Guerrero Tel: 744-48-32627</p>	<p>Monterrey: Global Product Services Mar Caribe # 1987, Esquina con Golfo Pérsico Fracc. Bernardo Reyes, CP 64280 Monterrey N.L. México Tel: 8129-5103 E-Mail: aydeem@gps1.com.mx</p>
<p>MERIDA: ELECTROSER Av Reforma No. 403Gx39 y 41 Mérida, Yucatán, México CP97000 Tel: (52) 999-925-1916 E-Mail: rrrb@sureste.com</p>	<p>Oaxaca, Oax.: CENTRO DE DISTRIBUCION Y SERVICIO, S.A. de C.V. Murguía # 708 P.A., Col. Centro, 68000, Oaxaca Tel: 01(52)95-15-15-22-22 Fax: 01(52)95-15-13-67-00 E-Mail: gpotai2001@hotmail.com</p>
<p>Tijuana: STD Av Ferrocarril Sonora #3780 L-C Col 20 de Noviembre Tijuana, Mexico</p>	<p>FOR USA SUPPORT: ViewSonic Corporation 381 Brea Canyon Road, Walnut, CA. 91789 USA Tel: 800-688-6688 (English); 866-323-8056 (Spanish); Fax: 1-800-685-7276 E-Mail: http://www.viewsonic.com</p>



ViewSonic®



2001171222P