



BG-S7

BATTERY GRIP

Designed for the
Sony Alpha a7R IV and a9 II
Mirrorless Cameras

 VELLO®

Thank you for choosing Vello.

The Vello BG-S7 battery grip offers extended shooting time and comfort when shooting in a vertical (portrait) orientation. The grip is compatible with the Sony a7R IV and a9 II mirrorless cameras and accepts up to two Sony NP-FZ100 rechargeable batteries. It offers an alternate shutter release button, AF-ON and AEL buttons, two custom buttons, a multi-selector, and front and rear dials. This makes the grip ideal for shooting portrait photography. There is also a convenient control-lock switch to prevent unwanted triggering of the grip's controls. For connectivity, there is a mount on the bottom for standard tripods and a mount on the top for hand straps.

Please read through this entire manual before using the BG-S7 battery grip.



Precautions

- 1.** The BG-S7 should be used only with compatible devices specified in this manual.
- 2.** Use only with the batteries and battery holders recommended in this manual.
- 3.** If you notice smoke, noise, or an unusual smell from the battery pack, discontinue use immediately. Remove the batteries, and take the device to a Vello authorized reseller.
- 4.** The battery level may not display properly if batteries are installed before mounting the grip.
- 5.** Remove batteries from the grip when not in use.
- 6.** Do not attempt to disassemble.
- 7.** Avoid exposing this product to water or extreme humidity, and keep it in a cool, dry place.
- 8.** Keep out of reach of children.
- 9.** All images are for illustrative purposes only.

Overview

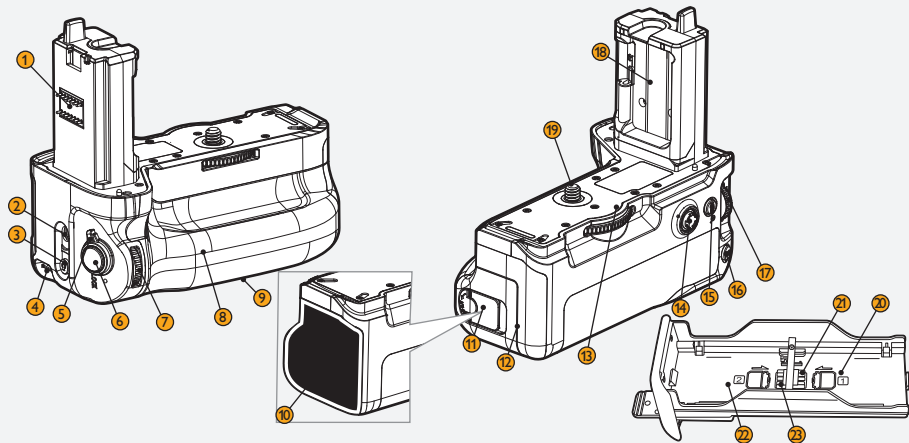

- ① Electrical contacts
- ② C2 custom button
- ③ C1 custom button
- ④ Hand strap mount
- ⑤ Control lock switch
- ⑥ Shutter release button
- ⑦ Front dial
- ⑧ Nonslip grip

- ⑨ Tripod socket
- ⑩ Battery compartment
- ⑪ Battery tray lock
- ⑫ Battery tray
- ⑬ Thumbwheel lock
- ⑭ Multi-selector
- ⑮ AF-ON / enlarge viewing
- ⑯ AEL button / preview zoom

- ⑰ Rear dial
- ⑱ Camera battery door holder
- ⑲ Mounting screw
- ⑳ Battery slot 1
- ㉑ Slot 1 contacts
- ㉒ Battery slot 2
- ㉓ Slot 2 contacts

Attaching the Battery Grip

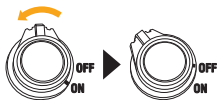

1. Ensure that the camera's power is turned off.

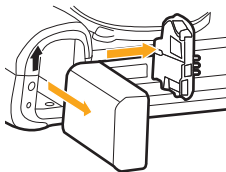

2. Open the camera's battery door, and remove the battery. Remove the camera's battery door by pulling the release latch on the inside of the door as indicated above.

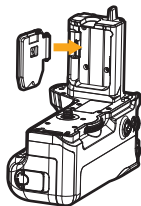

3. Store the camera's battery door in the BG-S7's battery door holder. Align the door with the compartment's slot as indicated, and slide the door in. Press the door's release latch to lock it in place.

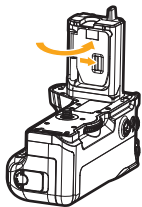

- 4.** Swing and lock the door shut.

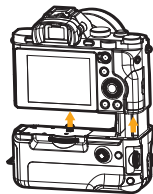

- 5.** Insert the BG-S7's electrical contacts into the camera's battery chamber, and seat the camera onto the grip's mounting screw.

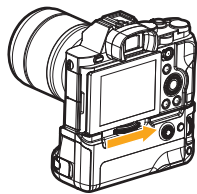

- 6.** Rotate the thumbwheel lock until secure.

Inserting the Batteries

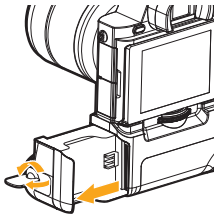

1. Turn the camera power off. Rotate the grip's battery tray lock to Open, and pull the tray out of the battery compartment.

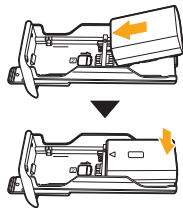

2. Align your battery's contacts with either battery tray slot 1 or 2, and insert the battery. Make sure the battery is secure.

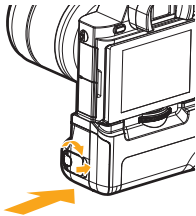

3. Slide the battery tray into the grip's battery compartment, and rotate the tray's lock to Close.

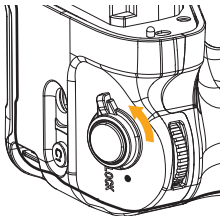

4. Turn on the camera's power, and make sure the grip's control lock switch is set to •.

Note: When removing the grip, turn off the camera power, and remove the batteries.

Battery Status

When two batteries are installed in the BG-S7, your camera will automatically select the battery with less power remaining. The battery level will appear on your camera's LCD, with the battery level percentage for only the battery in use. When the battery is depleted, your camera will switch to the other battery in the grip.

Important: When storing your Sony camera with the grip attached, turn your camera off, and turn the grip's control lock switch to the locked position.

Specifications

Power source	Up to two NP-FZ100 rechargeable Li-ion batteries
Operating temperature	32°F to 104°F (0°C to 40°C)
Dimensions (H × W × D)	4.3 × 5 × 2.55 in. (10.9 × 12.8 × 6.5 cm)
Weight	8 oz. (227 g) without batteries

ONE-YEAR LIMITED WARRANTY

This VELLO product is warranted to the original purchaser to be free from defects in materials and workmanship under normal consumer use for a period of one (1) year from the original purchase date or thirty (30) days after replacement, whichever occurs later. The warranty provider's responsibility with respect to this limited warranty shall be limited solely to repair or replacement, at the provider's discretion, of any product that fails during normal use of this product in its intended manner and in its intended environment. Inoperability of the product or part(s) shall be determined by the warranty provider. If the product has been discontinued, the warranty provider reserves the right to replace it with a model of equivalent quality and function.

This warranty does not cover damage or defect caused by misuse, neglect, accident, alteration, abuse, improper installation or maintenance. EXCEPT AS PROVIDED HEREIN, THE WARRANTY PROVIDER MAKES NEITHER ANY EXPRESS WARRANTIES NOR ANY IMPLIED WARRANTIES, INCLUDING BUT NOT LIMITED TO ANY IMPLIED WARRANTY OF MERCHANTABILITY OR FITNESS FOR A PARTICULAR PURPOSE. This warranty provides you with specific legal rights, and you may also have additional rights that vary from state to state.

To obtain warranty coverage, contact the Vello Customer Service Department to obtain a return merchandise authorization ("RMA") number, and return the defective product to Vello along with the RMA number and proof of purchase. Shipment of the defective product is at the purchaser's own risk and expense.

For more information or to arrange service, visit www.vellogear.com or call Customer Service at 212-594-2353.

Product warranty provided by the Gradus Group.

www.gradusgroup.com

VELLO is a registered trademark of the Gradus Group. © 2020 Gradus Group LLC. All Rights Reserved.



All other trademarks are the property of their respective owners.

GG1