

# SONY®

## Home Audio System

---

Operating Instructions US

---

Mode d'emploi FR

---

Manual de instrucciones ES

## For the customers in the USA

### Owner's Record

The model and serial numbers are located on the rear of the unit. Record these numbers in the spaces provided below. Refer to them whenever you call upon your Sony dealer regarding this product.

Model No. \_\_\_\_\_

Serial No. \_\_\_\_\_

## WARNING

**To reduce the risk of fire or electric shock, do not expose this apparatus to rain or moisture.**

To reduce the risk of fire, do not cover the ventilation opening of the appliance with newspapers, tablecloths, curtains, etc.

Do not expose the appliance to naked flame sources (for example, lighted candles).

To reduce the risk of fire or electric shock, do not expose this appliance to dripping or splashing, and do not place objects filled with liquids, such as vases, on the appliance.

As the main plug is used to disconnect the unit from the mains, connect the unit to an easily accessible AC outlet. Should you notice an abnormality in the unit, disconnect the main plug from the AC outlet immediately.

Do not install the appliance in a confined space, such as a bookcase or built-in cabinet.

Do not expose batteries or appliances with battery-installed to excessive heat, such as sunshine and fire.

The unit is not disconnected from the mains as long as it is connected to the AC outlet, even if the unit itself has been turned off.

Indoor use only.

## CAUTION

The use of optical instruments with this product will increase eye hazard.

CLASS 1 LASER PRODUCT  
LASER KLASSE 1  
LUOKAN 1 LASERLÄITE  
KLASS 1 LASERAPPARAT

This appliance is classified as a CLASS 1 LASER product under IEC 60825-1:2007. This marking is located on the rear exterior of the unit.

**FOR UNITED STATES CUSTOMERS. NOT APPLICABLE IN CANADA, INCLUDING IN THE PROVINCE OF QUEBEC.**

**POUR LES CONSOMMATEURS AUX ÉTATS-UNIS. NON APPLICABLE AU CANADA, Y COMPRIS LA PROVINCE DE QUÉBEC.**

## For the customers in the USA



This symbol is intended to alert the user to the presence of uninsulated "dangerous voltage" within the product's enclosure that may be of sufficient magnitude to constitute a risk of electric shock to persons.



This symbol is intended to alert the user to the presence of important operating and maintenance (servicing) instructions in the literature accompanying the appliance.

## Important Safety Instructions

- 1) Read these instructions.
- 2) Keep these instructions.
- 3) Heed all warnings.
- 4) Follow all instructions.
- 5) Do not use this apparatus near water.
- 6) Clean only with dry cloth.
- 7) Do not block any ventilation openings. Install in accordance with the manufacturer's instructions.
- 8) Do not install near any heat sources such as radiators, heat registers, stoves, or other apparatus (including amplifiers) that produce heat.
- 9) Do not defeat the safety purpose of the polarized or grounding-type plug. A polarized plug has two blades with one wider than the other. A grounding type plug has two blades and a third grounding prong. The wide blade or the third prong are provided for your safety. If the provided plug does not fit into your outlet, consult an electrician for replacement of the obsolete outlet.
- 10) Protect the power cord from being walked on or pinched particularly at plugs, convenience receptacles, and the point where they exit from the apparatus.
- 11) Only use attachments/accessories specified by the manufacturer.
- 12) Use only with the cart, stand, tripod, bracket, or table specified by the manufacturer, or sold with the apparatus. When a cart is used, use caution when moving the cart/apparatus combination to avoid injury from tip-over.



- 13) Unplug this apparatus during lightning storms or when unused for long periods of time.
- 14) Refer all servicing to qualified service personnel. Servicing is required when the apparatus has been damaged in any way, such as power-supply cord or plug is damaged, liquid has been spilled or objects have fallen into the apparatus, the apparatus has been exposed to rain or moisture, does not operate normally, or has been dropped.

### NOTE:

This equipment has been tested and found to comply with the limits for a Class B digital device, pursuant to Part 15 of the FCC Rules. These limits are designed to provide reasonable protection against harmful interference in a residential installation. This equipment generates, uses and can radiate radio frequency energy and, if not installed and used in accordance with the instructions, may cause harmful interference to radio communications. However, there is no guarantee that interference will not occur in a particular installation. If this equipment does cause harmful interference to radio or television reception, which can be determined by turning the equipment off and on, the user is encouraged to try to correct the interference by one or more of the following measures:

- Reorient or relocate the receiving antenna.
- Increase the separation between the equipment and receiver.
- Connect the equipment into an outlet on a circuit different from that to which the receiver is connected.
- Consult the dealer or an experienced radio/TV technician for help.

## CAUTION

You are cautioned that any changes or modifications not expressly approved in this manual could void your authority to operate this equipment.

Properly shielded and grounded cables and connectors must be used for connection to host computers and/or peripherals in order to meet FCC emission limits.

This equipment must not be co-located or operated in conjunction with any other antenna or transmitter.

This equipment complies with FCC radiation exposure limits set forth for an uncontrolled environment and meets the FCC radio frequency (RF) Exposure Guidelines. This equipment should be installed and operated keeping the radiator at least 20 cm or more away from person's body.

## For the customers in Canada

Properly shielded and grounded cables and connectors must be used for connection to host computers and/or peripherals.

This device complies with Industry Canada's licence-exempt RSSs. Operation is subject to the following two conditions:

- (1) This device may not cause interference; and
- (2) This device must accept any interference, including interference that may cause undesired operation of the device.

This equipment complies with IC radiation exposure limits set forth for an uncontrolled environment and meets RSS-102 of the IC radio frequency (RF) Exposure rules. This equipment should be installed and operated keeping the radiator at least 20 cm or more away from person's body.

## License and Trademark Notice

- "CD" logo is trademark.
- WALKMAN® and WALKMAN® logo are registered trademarks of Sony Corporation.
- MPEG Layer-3 audio coding technology and patents licensed from Fraunhofer IIS and Thomson.
- Windows Media is either a registered trademark or trademark of Microsoft Corporation in the United States and/or other countries.
- This product is protected by certain intellectual property rights of Microsoft Corporation. Use or distribution of such technology outside of this product is prohibited without a license from Microsoft or an authorized Microsoft subsidiary.
- LDAC™ and LDAC logo are trademarks of Sony Corporation.
- The BLUETOOTH® word mark and logos are registered trademarks owned by Bluetooth SIG, Inc. and any use of such marks by Sony Corporation is under license. Other trademarks and trade names are those of their respective owners.
- The N-Mark is a trademark or registered trademark of NFC Forum, Inc. in the United States and in other countries.
- Android™ is a trademark of Google Inc.
- Google Play is a trademark of Google Inc.
- Apple, iPhone, iPod, and iPod touch are trademarks of Apple Inc., registered in the U.S. and other countries. App Store is a service mark of Apple Inc., registered in the U.S. and other countries.

- Use of the Made for Apple badge means that an accessory has been designed to connect specifically to the Apple product(s) identified in the badge, and has been certified by the developer to meet Apple performance standards. Apple is not responsible for the operation of this device or its compliance with safety and regulatory standards.
- All other trademarks are trademarks of their respective owners.
- In this manual, ™ and ® marks are not specified.

---

## About this manual

- The instructions in this manual are for models SHAKE-X30 and SHAKE-X10. In this manual, the SHAKE-X30 is used for illustration purpose unless stated otherwise.
- This manual mainly explains operations using the remote control, but the same operations can also be performed using the buttons on the unit having the same or similar names.
- Icons, such as , listed at the top of each explanation indicate the type of media that can be used with the function being explained.
- Some illustrations are presented as conceptual drawings, and may be different from the actual products.
- The text enclosed in double quotation mark (“--”) appears on the display.

---

# Table of Contents

About this manual .....	5
Unpacking .....	8
Playable discs or files on discs/USB device .....	8
Websites for compatible devices .....	10
Guide to parts and controls .....	11

---

## Getting Started

Hooking up the system securely .....	15
Deactivating the demonstration .....	17
Inserting batteries .....	17
Positioning the speakers .....	17
Listening to TV sound via the system .....	18
Changing the display mode .....	19

---

## Disc/USB Playback

Before using the USB device .....	19
Basic playback .....	19
Using play mode .....	20
Viewing information on the display .....	21

---

## USB Transfer

Before using the USB device .....	21
Transferring music .....	21

---

## Tuner

Listening to the radio .....	24
------------------------------	----

---

## BLUETOOTH

About the BLUETOOTH wireless technology .....	25
Pairing this system with a BLUETOOTH device .....	26
Listening to music on a BLUETOOTH device .....	27
One Touch BLUETOOTH Connection by NFC .....	28
Setting the BLUETOOTH audio codecs .....	29
Setting the BLUETOOTH standby mode .....	29
Turning on or off the BLUETOOTH signal .....	30
Controlling the system using a smartphone or tablet (SongPal) .....	30
Getting frenzied parties with the "Fiestable" app .....	31

---

## Sound Adjustment

Adjusting the sound .....	32
Selecting the Virtual Football mode .....	32
Creating your own sound effect .....	32
Creating a party atmosphere (DJ Effect) .....	33

---

## Other Operations

Using the Party Chain function.....	34
Singing along: Karaoke .....	37
Using the Voice Guidance....	38
Enjoying sound from a guitar.....	38
Enjoying music with the Party Light and Speaker Light .....	39
Using the Sleep Timer .....	39
Using optional equipment...	39
Deactivating the buttons on the unit (Child Lock) .....	39
Setting the automatic standby function.....	40
Updating the software.....	40

---

## Additional Information

Troubleshooting .....	41
Precautions .....	47
Specifications.....	49

---

## Unpacking

- Remote control (1)
- R03 (size AAA) batteries (2)
- FM lead antenna (1)
- AC power cord (mains lead) (1)

### SHAKE-X30 only

- Unit: HCD-SHAKE30 (1)
- Speaker system: SS-SHAKE30 (2)

### SHAKE-X10 only

- Unit: HCD-SHAKE10 (1)
- Speaker system: SS-SHAKE10 (2)

#### Note

When unpacking or handling a big and/or heavy speaker, be sure to handle the speaker with two or more persons. Dropping the speaker may cause personal injury and/or property damage.

---

## Playable discs or files on discs/USB device

### Playable discs

- AUDIO CD
- CD-R/CD-RW in AUDIO CD format

### Playable files on discs

MP3 files (.mp3)<sup>\*1\*2</sup>

### Playable files on USB device

MP3 files (.mp3)<sup>\*1\*2</sup>, WMA files (.wma)<sup>\*2</sup>, AAC files (.m4a/.mp4/.3gp)<sup>\*2</sup>, WAV files (.wav)<sup>\*2</sup>

#### Note

- The CD-ROM/-R/-RW must be in DATA CD format that contains the MP3<sup>\*1\*2</sup> files, and conforms to ISO 9660<sup>\*3</sup> Level 1/Level 2 or Joliet (extended format).

- The system will attempt to play back any data with the extensions above, even if it is not in the supported format. Playing this data may generate a loud noise which could damage your speaker system.

<sup>\*1</sup> MP3 (MPEG 1 Audio Layer 3) is a standard format defined by ISO/MPEG for compressed audio data. MP3 files must be in MPEG 1 Audio Layer 3 format.

<sup>\*2</sup> Files with copyright protection (Digital Rights Management) cannot be played back by the system.

<sup>\*3</sup> A logical format of files and folders on CD-ROMs, defined by ISO (International Organization for Standardization).

### Discs/files that cannot be played back

- You cannot play back the following discs
  - CD-ROMs recorded in PHOTO CD format
  - Data part of CD-Extra or Mixed Mode CDs\*
  - CD Graphics disc
  - Super Audio CDs
  - DATA CD that is created in Packet Write format
  - DATA CD which has not been correctly finalized
  - A disc that has a non-standard shape (e.g., heart, square, star)
  - A disc that has adhesive tape, paper, or a sticker attached to it
- You cannot play back the following files
  - A WMA file in WMA DRM, WMA Lossless, or WMA PRO format.
  - An AAC file in AAC DRM or AAC Lossless format.
  - The AAC files which is encoded at 96 kHz.
  - Files that are encrypted or protected by passwords.

- Files with DRM (Digital Rights Management) copyright protection.
- The MP3 PRO audio file can be played back as MP3 file.
- \* Mixed Mode CD: This format records data on the first track and audio (AUDIO CD data) on the second and subsequent tracks of a session.

### Notes on CD-R/-RW

In some cases, a CD-R/-RW cannot be played back on this system due to the recording quality or physical condition of the disc, or the characteristics of the recording device and authoring software. For more information, refer to the operating instructions of the recording device.

### Notes on discs

- This product is designed to play back discs that conform to the Compact Disc (CD) standard.
- DualDisc and some music discs encoded with copyright protection technologies do not conform to the CD standard. Therefore, these discs may not be compatible with this product.

### Note on multisession disc

- This system can play back multisession discs when an MP3 file is contained in the first session. Any subsequent MP3 files recorded in later sessions can also be played back (If later sessions contain AUDIO CD format, the system cannot play back this multisession discs).
- If the first session is recorded in AUDIO CD format, only the first session will be played back.

### Notes on playable files

- Playback may take a longer time to start when:
  - a DATA CD/USB device is recorded with a complicated tree structure.
  - the audio files in another folder have just been played back.
- The system can play back a DATA CD or a USB device in the following conditions:
  - up to a depth of 8 folders
  - up to 300 folders
  - up to 999 files in a disc
  - up to 2,000 files in a USB device
  - up to 650 files in a folder
 These numbers may vary depending on the file or folder configuration.
- Folders that have no audio files are skipped.
- Files transferred by a device such as a computer may not be played back in the order in which they were transferred.
- The playback order may not be applicable depending on the software used for creating the audio file.
- Compatibility with all encoding/writing software of the supported formats, recording devices, and recording media cannot be guaranteed.

### Notes about USB devices

- This system is not guaranteed to operate with all USB devices.
- Although there are a variety of complex functions for USB devices, the playable contents of USB devices connected to the system are music contents only. For details, refer to the operating instructions of the USB device.

- When a USB device is inserted, the system reads all the files on the USB device. If there are many folders or files on the USB device, it may take a long time to finish reading the USB device.
  - Do not connect the system and the USB device through a USB hub.
  - With some connected USB devices, there may be a delay before an operation is performed by this system.
  - The playback order for the system may differ from the playback order of the connected USB device.
  - Before using a USB device, make sure that no virus-ridden files are on the USB device.
- iPhone 5c
  - iPhone 5
  - iPhone 4s
  - iPod touch (6th generation)
  - iPod touch (5th generation)

---

## Websites for compatible devices

Check the websites below for the latest information about compatible USB and BLUETOOTH devices.

**For customers in the United States:**

<<https://esupport.sony.com/US/>>

**For customers in Canada:**

<<http://esupport.sony.com/CA/>>

### Compatible iPhone/iPod models

The compatible iPhone/iPod models are as follows. Update your iPhone/iPod with the latest software before using with the system.

Made for

- iPhone 7
- iPhone 7 Plus
- iPhone SE
- iPhone 6s
- iPhone 6s Plus
- iPhone 6
- iPhone 6 Plus
- iPhone 5s

## Guide to parts and controls

You can lock the keys except  (power) on the unit to prevent them from being operated by mistake (page 39).

### Unit (Top)

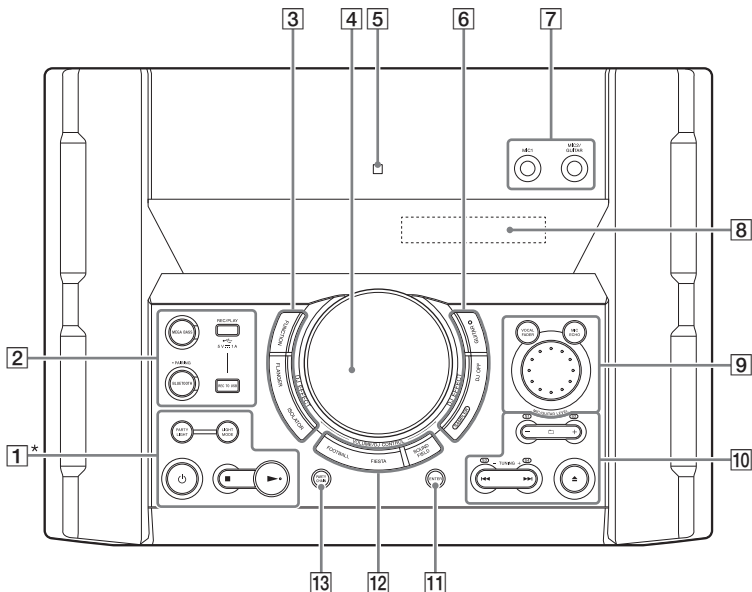

### Unit (Front)

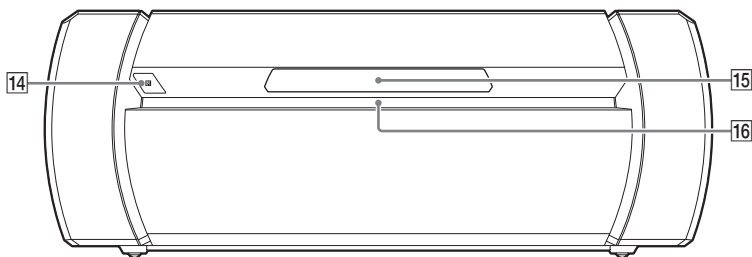

\* The  button has a tactile dot. Use the tactile dot as a reference when operating the system.

**1**  (power)

Turns on the system, or sets it to standby mode.

**■** (stop)

- Stops playback.  
When pressed twice, resume playback can be canceled.
- Stops transfer during music transfer.
- Stops the built-in sound demonstration.

**▶** (play)

Starts playback.  
Hold down **▶** for more than 2 seconds, the built-in sound demonstration will be played back. To stop the demonstration, press **■**.

**PARTY LIGHT** (page 19, 39)

**LIGHT MODE** (page 39)

**2** **BLUETOOTH**

Selects BLUETOOTH function.

**BLUETOOTH indicator**  
(page 25)

**– PAIRING**

Hold down to activate BLUETOOTH pairing during BLUETOOTH function.

**REC TO USB**

Transfers music to the USB device connected to the  (USB) port.

**MEGA BASS** (page 32)

**MEGA BASS indicator**

Lights up when MEGA BASS sound effect is selected.

 (USB) (REC/PLAY) port

Use to connect a USB device. This port can be used for both playback and music transfer.

**3** **FUNCTION**

Selects a function.

**FLANGER** (page 33)

**ISOLATOR** (page 33)

**4** **VOLUME/DJ CONTROL knob**

Adjusts the volume.\*  
Adjusts the FLANGER and ISOLATOR effect or outputs the SAMPLER sound effect continuously (page 33).

\* You cannot use this knob to adjust the volume when DJ Effect is selected.

**5**  (N-Mark) (page 28)

**6** **GUITAR** (page 37)

**GUITAR indicator**

Lights up when guitar mode is turned on.

**DJ OFF** (page 33)

**SAMPLER** (page 33)

**7** **MIC1 jack**

Use to connect the microphone.

**MIC2/GUITAR jack**

Use to connect the microphone or guitar.

**8** **Display**

**9** **VOCAL FADER** (page 37)

**MIC ECHO** (page 37)

## MIC/GUITAR LEVEL knob (page 37, 38)

- 10 +/- (select folder)  
Selects a folder on a data disc or a USB device.

## S1, S2, S3, S4 (page 33)

### ▲ (open/close)

Opens or closes the disc tray.

### ◀◀/▶▶ (go backward/go forward) (page 20)

## TUNING+/- (page 24)

- 11 ENTER  
Enters the settings.
- 12 FOOTBALL (page 32)  
FIESTA (page 32)  
SOUND FIELD (page 32)
- 13 PARTY CHAIN (page 36)
- 14 Remote control sensor  
(page 17)
- 15 Disc tray
- 16 Front panel lighting  
If the front panel lighting is glaring, do not look directly at it.

## Speaker (Rear)

Example:

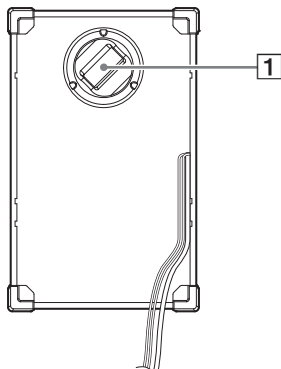

### 1 Party Light

Do not look directly at the light emitting part when the Party Light is turned on.

## Remote control

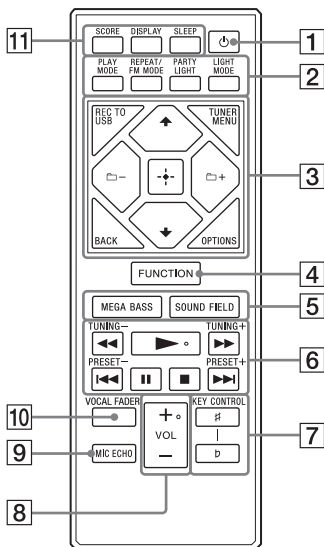

**1**  (power)  
Turns on the system, or sets it to standby mode.

**2** **PLAY MODE** (page 20, 22)

**REPEAT/FM MODE** (page 21, 24)

**PARTY LIGHT** (page 19, 39)

**LIGHT MODE** (page 39)

**3** **REC TO USB**

Transfers music to the USB device connected to the  (USB) port.

**TUNER MENU** (page 24)

**BACK**

Returns to the previous display.

**OPTIONS**

Enters or exits options menu.



Selects the menu items.

 +/- (select folder)

Selects a folder on a data disc or a USB device.

 (enter)

Enters or confirms the settings.

**4** **FUNCTION**

Selects a function.

**5** **MEGA BASS** (page 32)

**SOUND FIELD** (page 32)

**6**  (fast reverse/fast forward) (page 20)

**TUNING+/-** (page 24)

 (play)\*

Starts playback.

 (go backward/go forward) (page 20)

**PRESET+/-** (page 25)

 (pause)

Pauses playback. To resume playback, press .

 (stop)

— Stops playback.

When pressed twice, resume playback can be canceled.

— Stops transfer during music transfer.

— Stops the built-in sound demonstration.

**7** **KEY CONTROL #/b** (page 37)

**8** **VOL (volume) +/-\***

Adjusts the volume.

**9** **MIC ECHO** (page 37)

**10** **VOCAL FADER** (page 37)

**11** **SCORE** (page 37)

**DISPLAY** (page 17, 19, 21, 26)

Changes the information on the display.

**SLEEP** (page 39)

\* The VOL + and  buttons have a tactile dot. Use the tactile dot as a reference when operating the system.

### Hooking up the system securely

#### Unit (Rear)

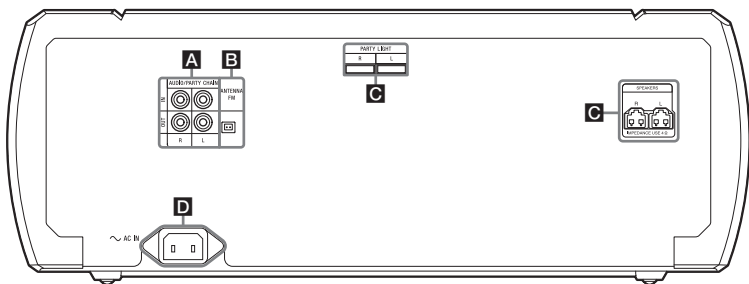

#### **A** Audio input and output jacks

Use an audio cable (not supplied) to make either connection as follows:

- **AUDIO/PARTY CHAIN IN L/R jacks**
  - Connect to the audio output jacks of a TV or an audio/video equipment. The sound is output through this system.
  - Connect to another audio system to enjoy the Party Chain function (page 34).
- **AUDIO/PARTY CHAIN OUT L/R jacks**
  - Connect to the audio input jacks of an optional equipment.
  - Connect to another audio system to enjoy the Party Chain function (page 34).

#### **B** FM ANTENNA terminal

Find a location and an orientation that provide good reception when you set up the antennas.

Keep the antenna away from the speaker cables, the AC power cord (mains lead) and the USB cable to avoid picking up noise.



## **C** Speakers

- **PARTY LIGHT L/R terminals**

Connect the Party Light connector of the speaker to this terminal. The lighting on the speakers will react according to the music source. You can select the Party Light and Speaker Light according to your preference (page 39).

- **SPEAKERS L/R terminals**

Connect the speaker connector of the speaker to this terminal.

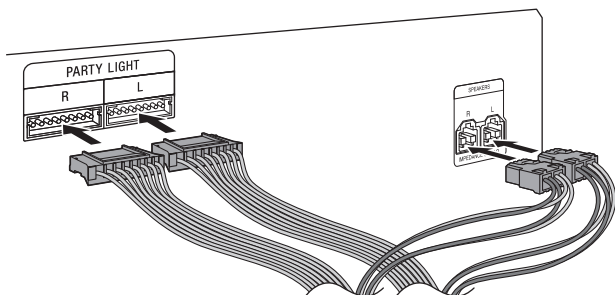

### **Note**

- Be sure to use only the supplied speakers.
- When connecting speaker cables, insert the connector straight into the terminals.

## **D** AC power cord (mains lead)

Connect the AC power cord (mains lead) (supplied) to the unit, then plug it into a wall outlet.

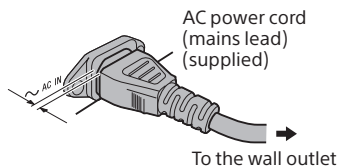

A small space is left between the plug and the unit even when the AC power cord (mains lead) is inserted firmly. The cord is supposed to be connected this way. This is not a malfunction.

When the AC power cord (mains lead) is connected, the demonstration (page 19) starts automatically. If you press **⏻** (power) to turn on the system, the demonstration ends.

## Deactivating the demonstration

To deactivate the demonstration while the system is turned off, press DISPLAY repeatedly to select the no display mode (Power Saving Mode) (page 19).

## Inserting batteries

Insert the two supplied R03 (size AAA) batteries, matching the polarities shown below.

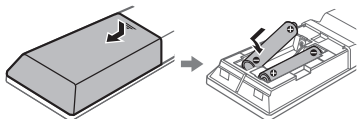

### Note

- Do not mix an old battery with a new one or mix different types of batteries.
- If you do not use the remote control for a long period of time, remove the batteries to avoid damage from battery leakage and corrosion.

## To operate the system using the remote control

Point the remote control at the unit's remote control sensor.

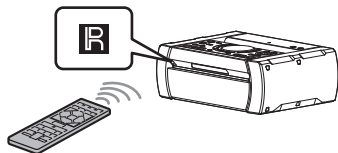

## Positioning the speakers

To obtain optimum performance from the system, we recommend you to place the speakers as shown below.

- (A) Unit
- (B) Left speaker (L)
- (C) Right speaker (R)

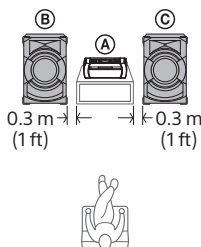

### Note

- Check the speaker type by referring to the speaker label ("L" or "R") on the rear panel of the speaker.
- To obtain optimum Party Light effects, we recommend you to place the speakers from the wall as shown below.

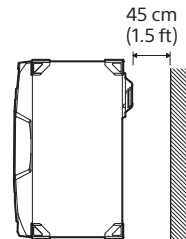

---

## Listening to TV sound via the system

Before connecting cables, be sure to disconnect the AC power cord (mains lead).

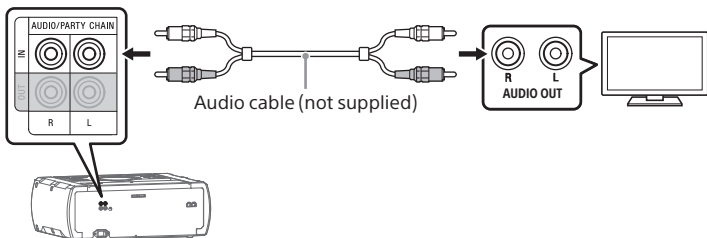

To listen to TV sound, press FUNCTION repeatedly to select "AUDIO IN".

### Hint

- You can also enjoy the sound of external equipment (DVD players, etc.) via the system by connecting to the AUDIO/PARTY CHAIN IN jacks. For details, refer to the operating instructions of your equipment.
- If the audio output level from the system is low when connecting the external equipment, try adjusting the audio output settings on the connected equipment. It may improve the audio output level. For details, refer to the operating instructions of your equipment.

## Changing the display mode

Press **DISPLAY** repeatedly while the system is turned off.

Each time you press the button, the display mode changes as follows.

### Demonstration

The messages about the main features of this system scrolls across the display and the illumination turns on.

To turn off the illumination, press **PARTY LIGHT**.

### No display (Power Saving Mode)

The display is turned off to conserve power.

## Disc/USB Playback

### Before using the USB device

For compatible USB devices, see "Websites for compatible devices" (page 10).

(You can use your Apple devices with this system via **BLUETOOTH** connection only.)

### Basic playback

**C D DATA CD USB**

- 1 Press **FUNCTION** repeatedly to select "CD" or "USB".
- 2 Prepare the playback source.

#### For CD function:

Press **▲** on the unit to open the disc tray and load a disc with the label facing up.

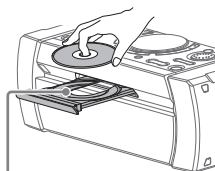

When you play back an 8 cm disc such as a CD single, place it on the inner circle of the tray.

Press **▲** on the unit again to close the disc tray.

Do not forcibly push the disc tray to close it as this may cause a malfunction.

### For USB function:









Connect a USB device to the  (USB) port.

#### Note

You can use a USB adaptor (not supplied) to connect the USB device to the unit if the USB device cannot be plugged into the  (USB) port.

## 3 Press to start playback.

### Other operations

To	Do this
Stop playback	Press  .
Pause playback	Press  .
Resume playback or return to normal playback	Press  .
Cancel the resume point	Press  twice.
Select a track or file	Press  or  during playback. (Operation might be prohibited by disc or USB device.)
Locate a point quickly in fast forward or fast reverse (Lock Search)	Press  or  during playback.

## Using play mode

### Playing in sequential order (Normal Play)

#### When playback is stopped, press **PLAY MODE** repeatedly.

The following indicator lights up on the display.

- (None): plays the disc or USB device.
- "FLDR"\*: plays all playable files in the specified folder on the disc or USB device.

\* Cannot be selected for AUDIO CD.

### Playing in random order (Shuffle Play)

#### When playback is stopped, press **PLAY MODE** repeatedly.

The following indicators light up on the display.

- "SHUF": shuffles all playable files on the disc or USB device.
- "FLDR SHUF"\*: shuffles all playable files in the specified folder on the disc or USB device.

\* Cannot be selected for AUDIO CD.



#### Note

- Shuffle Play is canceled when you:
  - open the disc tray.
  - perform Synchronized Transfer.
- Shuffle Play may be canceled when you select a folder or a track to play back.

## Playing repeatedly (Repeat Play)

### Press REPEAT repeatedly.

The following indicators light up on the display.

- : repeats all tracks or audio files on a folder/disc/USB device.
- : repeats a track or audio file.

### Note

Repeat Play is canceled when you:

- open the disc tray.
- perform Synchronized Transfer.

## Viewing information on the display

### Press DISPLAY repeatedly when the system is turned on.

You can view the information as follows:

- playing time/remaining time of track, file, disc
- file name, folder name
- title, artist name, and album name

### Note

- The disc name or track name may not be displayed depending on the characters.
- Playing time of audio files may not be displayed correctly.
- The elapsed playing time for an audio file encoded using a VBR (variable bit rate) is not displayed correctly.

## USB Transfer

### Before using the USB device

For compatible USB devices, see “Websites for compatible devices” (page 10).

(You can use your Apple devices with this system via BLUETOOTH connection only.)

### Transferring music

You can transfer music from a disc (AUDIO CD or MP3 disc only) to a USB device connected to the  (USB) port.

The audio format of files transferred by this system is MP3.

### Note

- Do not remove the USB device during transfer or erase operations. Doing so may corrupt the data on the USB device or damage the USB device itself.
- MP3 files are transferred with the same bit rate as the original files.
- When transferring from AUDIO CD, you may select the bit rate before transferring.
- USB transfer and erase operations are prohibited when the disc tray is opened.

### Note on copyright-protected content

The transferred music is limited to private use only. Use of the music beyond this limit requires permission of the copyright holders.

### To select the bit rate

You can select a higher bit rate to transfer music with better quality.

#### 1 Press OPTIONS.

- 2 Press **▲/▼** repeatedly to select "BIT RATE", then press **[+]**.
- 3 Press **▲/▼** repeatedly to select the bit rate you want, then press **[+]**.
  - "128 KBPS": encoded MP3 files have smaller file size and lower audio quality.
  - "256 KBPS": encoded MP3 files have bigger file size but higher audio quality.

To exit the options menu, press **OPTIONS**.

## Transferring music from a disc

You can transfer music to a USB device connected to **↔** (USB) port as follows:

- Synchronized Transfer: Transfer all tracks or MP3 files from a disc to USB.
- REC1 Transfer: Transfer a single track or MP3 file during playback.

Use the buttons on the unit to perform this operation.

### 1 Connect a transferable USB device to the **↔** (USB) port.

#### Note

You can use a USB adaptor (not supplied) to connect the USB device to the unit if the USB device cannot be plugged into the **↔** (USB) port.

### 2 Press **FUNCTION** repeatedly to select "CD" then load a disc.

### 3 Prepare the sound source.

#### Synchronized Transfer:

If the system starts playback automatically, press **■** twice to stop the playback fully.

When playback is stopped, press **PLAY MODE** on the remote control repeatedly to select the play mode you want.

#### Note

If you start transferring in Shuffle Play or Repeat Play, the selected play mode changes to Normal Play automatically.

#### REC1 Transfer:

Select the track or MP3 file you want to transfer, then start playback.

### 4 Press **REC TO USB**.

"PUSH ENTER" appears on the display.

### 5 Press **ENTER**.

The transfer starts, then "DO NOT REMOVE" appears on the display. Do not remove the USB device until the transfer is complete.

When the transfer is complete, the system performs as follows:

#### Synchronized Transfer:

The disc stops automatically.

#### REC1 Transfer:

The disc continues to play the next track or file.

### To stop transfer

Press **■**.

#### Notes on transfer

- While transferring, no sound is output.
- CD-TEXT information is not transferred to the created MP3 files.

- The transfer stops automatically if:
  - the USB device runs out of space during transfer.
  - the number of audio files or folders on the USB device reaches the limit that the system can recognize.
- If a folder or file that you are trying to transfer already exists on the USB device with the same name, a sequential number is added after the name without overwriting the original folder or file.
- You cannot perform the following operations during transfer:
  - Eject the disc.
  - Select another track or file.
  - Pause playback or find a point in the track or file.
  - Change the function.
- When transferring music to a WALKMAN® using "Media Manager for WALKMAN", be sure to transfer in MP3 format.
- When connecting a WALKMAN® to the system, be sure to connect after the display "Creating Library" or "Creating Database" on the WALKMAN® has disappeared.

## Folder and file generation rules

### Maximum number of MP3 files that can be generated

- 298 folders
- 650 files in a folder
- 650 files in REC1-CD or REC1-MP3 folder.

These numbers may vary depending on the file or folder configuration.

When transferring to a USB device, a "MUSIC" folder is created directly below "ROOT". Folders and files are generated within this "MUSIC" folder according to the transfer method and source as follows:

## Synchronized Transfer

### ■ When transferring CD-DA tracks from an AUDIO CD

Folder name: "CDDA0001"\*

File name: "TRACK001"\*

### ■ When transferring MP3 files from a disc

Folder name: Same as the source

File name: Same as the source

## REC1 Transfer

### ■ When transferring a CD-DA track from an AUDIO CD

Folder name: "REC1-CD"

File name: "TRACK001"\*

### ■ When transferring an MP3 file from a disc

Folder name: "REC1-MP3"

File name: Same as the source

\* Folder and file numbers are assigned serially thereafter.

## Erasing audio files or folders on the USB device

- 1 Press **FUNCTION** repeatedly to select "USB".
- 2 When playback is stopped, press **OPTIONS**.
- 3 Press **↔/↔** repeatedly to select "ERASE", then press **[+]**.
- 4 Press **↔/↔** repeatedly to select a folder, then press **[+]**.

**5** Press **↑/↓** repeatedly to select an audio file you want to erase, then press **[+]**.

If you want to erase all the audio files in the folder, select "ALL TRACKS".

"FLDR ERASE" or "TRK ERASE" and "PUSH ENTER" appear on the display.

To cancel erase operations, press **■**.

**6** Press **[+]**.

"COMPLETE" appears on the display. To exit the options menu, press **OPTIONS**.

**Note**

- You can erase the supported audio file, MP4 format file, and 3GP format file only.
- You cannot erase audio files or folders when Shuffle Play has been selected. Set the play mode to Normal Play before erasing.
- Erase operation is prohibited when the disc tray is opened.

## Tuner

### Listening to the radio

**1** Press **FUNCTION** repeatedly to select "TUNER FM".

**2** Tune to a station.

**For automatic scanning:**

Hold down **TUNING+/-** until the frequency begins to change on the display.

Scanning stops automatically when a station is tuned in. "STEREO" (for FM stereo programs only) lights up on the display.

If scanning does not stop, press **■** to stop scanning. Then, perform manual tuning (below).

**For manual tuning:**

Press **TUNING+/-** repeatedly to tune to the station you want.

**Hint**

To reduce static noise on a weak FM stereo station, press **FM MODE** repeatedly until "MONO" lights up on the display. You will lose the stereo effect, but reception will improve.

### Presetting radio stations

You can store up to 20 FM stations as your favorite stations.

**1** Tune to the station you want.

**2** Press **TUNER MENU**.

- 3** Press  $\uparrow/\downarrow$  repeatedly to select the preset number you want, then press  $\boxed{+}$ .

“COMPLETE” appears on the display and the station is stored.

If another station is already assigned to the selected preset number, that station is replaced by the new one.

### To listen to the preset station

Press PRESET+/- repeatedly to select the preset number you want.

## BLUETOOTH

### About the BLUETOOTH wireless technology

BLUETOOTH wireless technology is a short-range wireless technology that enables wireless data communication between digital devices.

#### Supported BLUETOOTH version, profiles and codecs

For details, see “BLUETOOTH section” (page 50).

#### Compatible BLUETOOTH devices

For details, see “Websites for compatible devices” (page 10).

### About the BLUETOOTH indicator

The BLUETOOTH indicator on the unit lights up or flashes in blue to show the BLUETOOTH status.

System status	Indicator status
BLUETOOTH standby	Flashes slowly
BLUETOOTH pairing	Flashes quickly
BLUETOOTH connection is established	Lights up

---

## Pairing this system with a BLUETOOTH device

Pairing is an operation where BLUETOOTH devices register with each other beforehand. Once a pairing operation is performed, it does not need to be performed again.

If your device is an NFC-compatible smartphone, the manual pairing procedure is not necessary. (See “One Touch BLUETOOTH Connection by NFC” (page 28).)

**1 Place the BLUETOOTH device within 1 meter (3.3 feet) from the unit.**

**2 Press BLUETOOTH on the unit to select the BLUETOOTH function.** “BLUETOOTH” appears on the display.

### Hint

- When there is no pairing information on the system (for example, when you use the BLUETOOTH function for the first time after purchase), “PAIRING” flashes on the display and the system enters the pairing mode. Proceed to step 4.
- If the system is connected to a BLUETOOTH device, press BLUETOOTH on the unit to disconnect the BLUETOOTH device.

**3 Hold down – PAIRING on the unit for 2 seconds or more.** “PAIRING” flashes on the display.

**4 Perform the pairing procedure on the BLUETOOTH device.**

For details, refer to the operating instructions of your BLUETOOTH device.

**5 Select the system’s name (for example, “SHAKE-X30”) on the display of the BLUETOOTH device.**

Perform this step within 5 minutes, otherwise pairing will be canceled. In this case, repeat from step 3.

### Note

If passkey is required on the BLUETOOTH device, enter “0000”. “Passkey” may be called “Passcode”, “PIN code”, “PIN number”, or “Password”.

**6 Establish connection with the BLUETOOTH device.**

When pairing is completed and the BLUETOOTH connection is established, BLUETOOTH device name appears on the display.

Depending on the BLUETOOTH device, connection may start automatically after pairing is completed.

You can check the BLUETOOTH device address by pressing DISPLAY repeatedly.

### Note

- You can pair up to 9 BLUETOOTH devices. If the 10th BLUETOOTH device is paired, the oldest paired device will be deleted.
- If you want to pair with another BLUETOOTH device, repeat steps 1 to 6.

**To cancel the pairing operation**

Hold down – PAIRING on the unit for 2 seconds or more until “BLUETOOTH” appears on the display.

## To erase pairing information

Use the buttons on the unit to perform this operation.

### 1 Press **BLUETOOTH** to select **BLUETOOTH** function.

"BLUETOOTH" appears on the display.

If the system is connected to a BLUETOOTH device, the BLUETOOTH device name appears on the display. Press BLUETOOTH to disconnect the BLUETOOTH device.

### 2 Hold down **ENTER** and **LIGHT MODE** for about 3 seconds.

"BT HISTORY CLEAR" appears on the display and all the pairing information is erased.

## Listening to music on a BLUETOOTH device

You can operate a BLUETOOTH device by connecting the system and the BLUETOOTH device using AVRCP.

Check the following before playing music:

- The BLUETOOTH function of the BLUETOOTH device is turned on.
- Pairing has been completed (page 26).

Once the system and the BLUETOOTH device are connected, you can control playback by pressing **▶**, **||**, **■**, **◀/▶** and **◀◀/▶▶**.

### 1 Press **BLUETOOTH** on the unit to select the **BLUETOOTH** function.

"BLUETOOTH" appears on the display.

### 2 Establish connection with the **BLUETOOTH** device.

Press BLUETOOTH on the unit to connect to the last connected BLUETOOTH device.

Perform the BLUETOOTH connection from the BLUETOOTH device if the device is not connected.

Once the connection is established, the BLUETOOTH device name appears on the display.

### 3 Press **▶** to start playback.

Depending on the BLUETOOTH device,

- you may need to press **▶** twice.
- you may need to start playing an audio source on the BLUETOOTH device.

### 4 Adjust the volume.

Adjust the volume of the BLUETOOTH device first. If the volume level is still too low, adjust the volume level on the system.

#### Note

- When the system is not connected to any BLUETOOTH device, the system will connect to the last connected BLUETOOTH device automatically when you press BLUETOOTH or **▶** on the unit.
- If you try to connect another BLUETOOTH device to the system, the current connected BLUETOOTH device will be disconnected.

### To terminate the **BLUETOOTH** connection

Press BLUETOOTH on the unit. "BLUETOOTH" appears on the display.

Depending on the BLUETOOTH device, the BLUETOOTH connection may be terminated automatically when you stop playback.

# One Touch BLUETOOTH Connection by NFC

NFC (Near Field Communication) is a technology enabling short-range wireless communication between various devices, such as smartphones and IC tags.

When you touch the system with an NFC-compatible smartphone, the system automatically:

- turns on in the BLUETOOTH function.
- completes the pairing and BLUETOOTH connection.

## Compatible smartphones

Smartphones with a built-in NFC function (OS: Android 2.3.3 or later, excluding Android 3.x)

### Note

- The system can only recognize and connects to one NFC-compatible smartphone at a time. If you try to connect another NFC-compatible smartphone to the system, the currently connected NFC-compatible smartphone will be disconnected.
- Depending on your NFC-compatible smartphone, you may need to perform the following steps on your NFC-compatible smartphone in advance.
  - Turn on the NFC function. For details, refer to the operating instructions of the NFC-compatible smartphone.
  - If your NFC-compatible smartphone has an OS version that is older than Android 4.1.x, download and start the “NFC Easy Connect” application. “NFC Easy Connect” is a free application for Android smartphones that can be obtained from Google Play. (The application may not be available in some countries/regions.)

- 1 Touch the smartphone to the N-Mark on the unit until the smartphone vibrates.

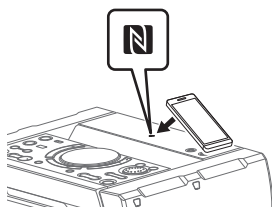

Complete the connection by following the instructions displayed on the smartphone.

When the BLUETOOTH connection is established, the BLUETOOTH device name appears on the display.

- 2 Start playback of an audio source on the smartphone.

For details, refer to the operating instructions of your BLUETOOTH device.

### Hint

If pairing and the BLUETOOTH connection fail, do the following.

- Remove the case from the smartphone if using a commercially available smartphone case.
- Touch the smartphone to the N-Mark on the unit again.
- Relaunch the “NFC Easy Connect” application.

## To terminate the BLUETOOTH connection

Touch the smartphone to the N-Mark on the unit again.

## Setting the BLUETOOTH audio codecs

You can enable AAC, LDAC or SBC codec reception from BLUETOOTH device. AAC/LDAC can be selected only when the BLUETOOTH device supports AAC/LDAC.

**1** Press **OPTIONS**.

**2** Press **↑/↓** repeatedly to select **"BT CODEC"**, then press **[+]**.

**3** Press **↑/↓** repeatedly to select the setting, then press **[+]**.

- "AUTO": Enable reception in AAC or LDAC codec format.
- "SBC": Receive in SBC codec format.

To exit the options menu, press **OPTIONS**.

### Note

- You can enjoy high quality sound if AAC or LDAC is selected. If you cannot listen to AAC or LDAC sound from your device or the sound is interrupted, select "SBC".
- If you change this setting while the system is connected to a BLUETOOTH device, the BLUETOOTH device will be disconnected. To connect to the BLUETOOTH device, perform the BLUETOOTH connection again.

### Hint

LDAC is an audio coding technology developed by Sony that enables the transmission of High-Resolution (Hi-Res) Audio content, even over a BLUETOOTH connection. Unlike other BLUETOOTH compatible coding technologies such as SBC, it operates without any down-conversion of the Hi-Res Audio content\*<sup>1</sup>, and allows approximately three times more data\*<sup>2</sup> than those other technologies to be transmitted over a BLUETOOTH wireless network with unprecedented sound quality, by means of efficient coding and optimized packetization.

\*<sup>1</sup> Excluding DSD format contents.

\*<sup>2</sup> In comparison with SBC (Subband Coding) when the bitrate of 990 kbps (96/48 kHz) or 909 kbps (88.2/44.1 kHz) is selected.

## Setting the BLUETOOTH standby mode

The BLUETOOTH standby mode enables the system to turn on automatically when you establish a BLUETOOTH connection from a BLUETOOTH device.

**1** Press **OPTIONS**.

**2** Press **↑/↓** repeatedly to select **"BT STBY"**, then press **[+]**.

**3** Press **↑/↓** repeatedly to select the setting, then press **[+]**.

- "ON": The system turns on automatically even when the system is in standby mode.
- "OFF": Turns off this function.

To exit the options menu, press **OPTIONS**.

---

## Turning on or off the BLUETOOTH signal

You can connect to the system from a paired BLUETOOTH device in all functions when the system's BLUETOOTH signal is set to on. The BLUETOOTH signal is turned on by default.

**Hold down ENTER and  on the unit for about 3 seconds.**

"BT ON" or "BT OFF" appears on the display.

### Note

- You cannot perform the following operations when BLUETOOTH signal is set to off:
  - Pair and/or connect with BLUETOOTH device
  - Erase the pairing information
  - Use "SongPal"
  - Change the BLUETOOTH audio codecs
- If you touch the N-Mark on the unit with an NFC-compatible smartphone or set the BLUETOOTH standby mode to on, the BLUETOOTH signal will be set to on automatically.



## Controlling the system using a smartphone or tablet (SongPal)

"SongPal" is a dedicated app for operating "SongPal"-compatible audio devices manufactured by Sony using a smartphone or tablet. Search for "SongPal" on Google Play™ or App Store and download it using your smartphone or tablet.

"SongPal" allows you to:

- change the function of the system, control the playback of the disc/USB device and tune to an FM station.
- browse the music content of disc/USB device.
- view the information of disc/USB such as playing time and title.
- adjust the volume and change sound setting.

### 1 Search for "SongPal" or scan the two-dimensional code below.



### 2 Download "SongPal" app on your device.

### 3 Connect the system and device by BLUETOOTH connection (page 25).

### 4 Launch "SongPal" and follow the on-screen instructions.

**Note**

- We recommend you to use the latest “SongPal” version.
- If the “SongPal” application does not work properly, press BLUETOOTH on the unit to terminate the BLUETOOTH connection, then perform the BLUETOOTH connection again so that the BLUETOOTH connection functions normally.
- Available operations via “SongPal” may differ depending on the audio devices.
- For more details on “SongPal”, refer to the following URL.  
<http://info.songpal.sony.net/help/>
- Specifications and display design of “SongPal” are subject to change without notice.



## Getting frenzied parties with the “Fiestable” app

You can control the party features of Sony’s Home Audio System with intuitive and fancy user interface with the “Fiestable” app. “Fiestable” allows you to control features such as DJ Effect, illumination and Karaoke.

Even if “Fiestable” is installed, the “Fiestable” icon is not displayed on the smartphone or tablet home screen. It is embedded in the “SongPal” app as a plug-in.

- 1 Search and download “SongPal” app on your device (page 30).**
- 2 Search and download “Fiestable” app from Google Play or App Store using your device.**

- 3 Connect the system and device by BLUETOOTH connection (page 25).**

- 4 Launch “SongPal” and touch the “Fiestable” icon at the top left corner.**

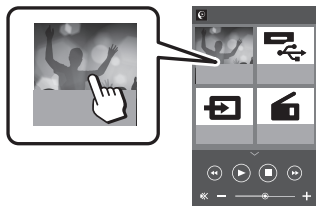
**Note**

For more details on “SongPal”, refer to the following URL.

<http://info.songpal.sony.net/help/>

## Sound Adjustment

### Adjusting the sound

To	Do this
Reinforce bass sound and create more powerful sound (MEGA BASS)	Press MEGA BASS on the unit to select "BASS ON". The MEGA BASS indicator lights up. To cancel, press MEGA BASS again to select "BASS OFF".
Reproduce the sound effect of a party hall (Fiesta)	Press FIESTA on the unit. "FIESTA" lights up on the display. To cancel, press SOUND FIELD repeatedly to select "FLAT".
Select a sound field	Press SOUND FIELD repeatedly. To cancel, press SOUND FIELD repeatedly to select "FLAT".

### Selecting the Virtual Football mode

You can experience the feeling of being in the stadium when watching a football match broadcast.

Note that you can only select Virtual Football mode during AUDIO IN function.

Press **FOOTBALL** on the unit repeatedly while watching a football match broadcast.

- "ON NARRATION": You can enjoy an immersive feeling of being in a football stadium through enhanced stadium cheers.
- "OFF NARRATION": You can enjoy a more immersive feeling of being in a football stadium by minimizing the volume level of narration in addition to the enhancement of cheers.

### To cancel the Virtual Football mode



Press **SOUND FIELD** repeatedly to select "FLAT".

#### Note

- We recommend that you select the Virtual Football mode when watching a football match broadcast.
- If you hear unnatural sounds in the content when "OFF NARRATION" is selected, "ON NARRATION" is recommended.
- This feature does not support monaural sound.

### Creating your own sound effect

You can raise or lower the levels of specific frequency bands, then store the setting in the memory as "CUSTOM EQ".

- 1 Press **OPTIONS**.
- 2 Press **↕/↗** repeatedly to select "CUSTOM EQ", then press .
- 3 Press **↕/↗** repeatedly to adjust the equalizer level, then press .

#### 4 Repeat step 3 to adjust the level of other frequency bands and surround effect.

To exit the options menu, press OPTIONS.

#### To select the custom equalizer setting

Press SOUND FIELD repeatedly to select "CUSTOM EQ".

## Creating a party atmosphere (DJ Effect)

Use the buttons on the unit to perform this operation.

### 1 Press the following button to select the effect type.

- **FLANGER:** Creates a deep flanging effect that is similar to the roar of a jet plane.
- **ISOLATOR:** Isolates a specific frequency band by adjusting the other frequency bands. For example, when you want to focus on vocals.
- **SAMPLER:** Provides a series of special sound effects.

### 2 Change the sound effect.

#### For FLANGER and ISOLATOR:

Turn the VOLUME/DJ CONTROL knob to adjust the effect level.

#### For SAMPLER:

Press SAMPLER repeatedly to select the SAMPLER mode you want, then press S1, S2, S3 or S4 to output the SAMPLER sound effect.

To output other SAMPLER sound effect continuously, turn the VOLUME/DJ CONTROL knob.

#### To turn off the effect

- Press DJ OFF.
- Press the selected effect button again (for FLANGER and ISOLATOR only).

#### Note

- The DJ Effect is automatically turned off when you:
  - turn off the system.
  - change the function.
  - activate or deactivate the PARTY CHAIN function.
  - change sound effect.
  - use the Vocal Fader.
  - change the key (Key Control).
- If you activate the DJ Effect during transferring, the sound effect will not be transferred onto the USB device.
- You cannot use VOLUME/DJ CONTROL knob on the unit to adjust the volume when the DJ Effect is activated. Press VOL +/- on the remote control to adjust the volume.

## Other Operations

### Using the Party Chain function

You can connect multiple audio systems in a chain to create a more interesting party environment and to produce higher sound output. An activated system in the chain will be the "Party Host" and share the music. Other systems will become "Party Guests" and play the same music as that being played by the "Party Host".

#### Setting up the Party Chain

Set up a Party Chain by connecting all the systems using audio cables (not supplied).

Before connecting cables, be sure to disconnect the AC power cord (mains lead).

#### **A** If all the systems are equipped with Party Chain function

Example: When connecting using this system as the first system

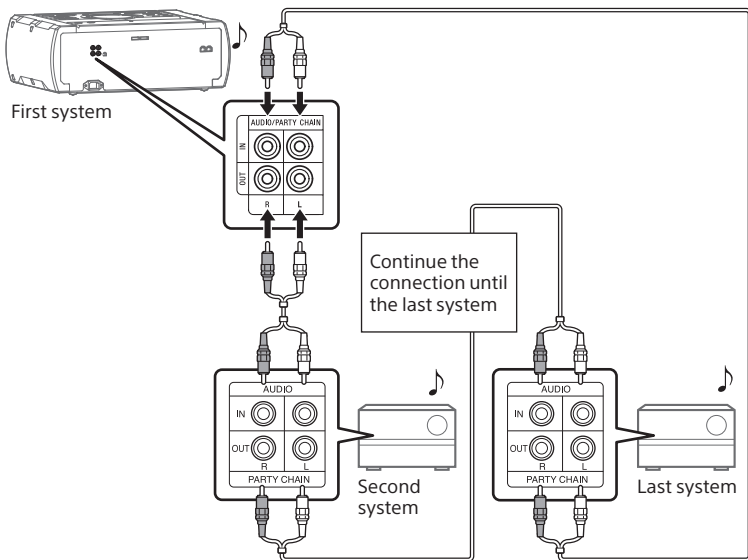

- The last system must be connected to the first system.
- Any system can become a Party Host.

- You can change the Party Host to another system in the chain. For details, see “To select a new Party Host (when all the systems are equipped with Party Chain function)” (page 36).

## **B** If one of the systems is not equipped with Party Chain function

Example: When connecting using this system as the first system

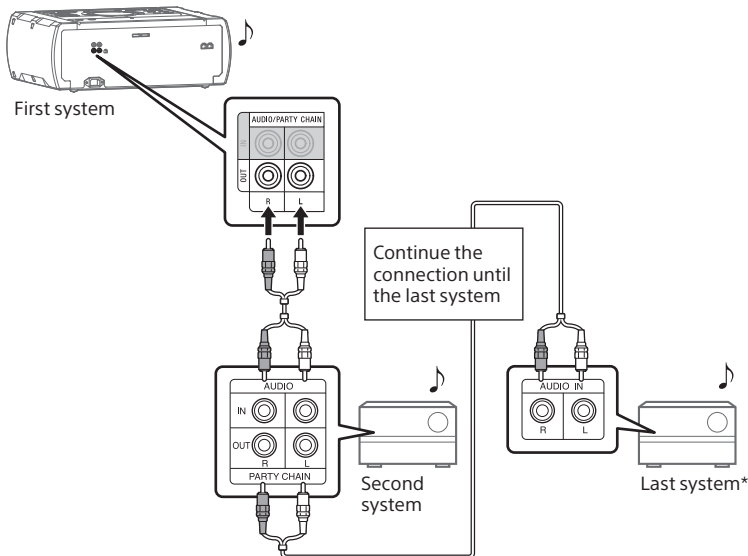

\* Connect the system which is not equipped with Party Chain function at the last system, otherwise the chain will stop at that system. Be sure to select the Audio In function on this last system.

- The last system is not connected to the first system.
- You must select the first system as Party Host so that all systems are playing the same music when Party Chain function is activated.

## Enjoying the Party Chain

**1 Plug in the AC power cord (mains lead) and turn on all the systems.**

**2 Adjust the volume on each system.**

**3 Activate the Party Chain function on the system to be used as the Party Host.**

### **Example: When using this system as the Party Host**

Press FUNCTION repeatedly on the unit to select the function you want (except when the AUDIO IN function is used in connection **A** (page 34)). Start playing the music, then press PARTY CHAIN on the unit.

"PARTY CHAIN" appears on the display. The Party Host starts the Party Chain, and other systems become Party Guests automatically. All systems play the same music as that being played by the Party Host.

### **Note**

- Depending on the total unit of systems you have connected, Party Guests may take some time to start playing the music.
- Changing the volume level and sound effect on the Party Host will not affect the output on the Party Guests.
- The Party Guest continues playing the music source as Party Host even when you change the function on Party Guest. However, you can adjust the volume and change the sound effect on Party Guest.
- When you use the microphone or play the guitar on Party Host, the sound will not be output from Party Guests.

- When one of the systems in the chain is performing USB transfer, wait for the system to complete or stop the transfer before you activate the Party Chain function.
- For detailed operation on other systems, refer to the operating instructions of the systems.

### **To select a new Party Host (when all the systems are equipped with Party Chain function)**

Repeat step 3 of "Enjoying the Party Chain" on the system to be used as a new Party Host. The current Party Host becomes Party Guest automatically. All systems play the same music as that being played by the new Party Host.

### **Note**

- You can select another system as the new Party Host only after the Party Chain function of all the systems in the Chain has been activated.
- If the selected system does not become a new Party Host after a few seconds, repeat step 3 under "Enjoying the Party Chain".

### **To deactivate the Party Chain**

Press PARTY CHAIN on the Party Host.

### **Note**

If the Party Chain function is not deactivated after a few seconds, press PARTY CHAIN on the Party Host again.

# Singing along: Karaoke

## Preparing for Karaoke

- 1** Turn **MIC/GUITAR LEVEL** knob on the unit anticlockwise to reduce the microphone volume level.
- 2** Press **GUITAR** on the unit repeatedly until **GUITAR** indicator lights off.
- 3** Connect an optional microphone to **MIC1** or **MIC2/GUITAR** jack on the unit.  
Connect another optional microphone if you want to sing in duet.
- 4** Start playing the music and adjust the microphone volume. Press **MIC ECHO** repeatedly to adjust the echo effect.
- 5** Start singing along with the music.

### Note

- If howling occurs:
  - move the microphone away from the speakers.
  - change the direction of the microphone.
  - turn **MIC/GUITAR LEVEL** knob on the unit anticlockwise.
  - press **MIC ECHO** repeatedly to adjust the echo level.
- Microphone sound will not be transferred to the USB device during USB transfer.

- You cannot adjust the microphone volume level using the **VOLUME/DJ CONTROL** knob on the unit or **VOL +/-** button on the remote control. Turn **MIC/GUITAR LEVEL** knob on the unit clockwise or anticlockwise to adjust the microphone volume level.

## Using Vocal Fader

You can reduce the sound of the vocal in stereo source.

Press **VOCAL FADER** repeatedly to select **"ON V.FADER"**.

To cancel Vocal Fader effect, press **VOCAL FADER** repeatedly to select **"OFF"**.

## Changing the key (Key Control)

Press **KEY CONTROL #/b** to suit your vocal range.

## Activating the Karaoke scoring mode (Score Mode)

You only can use scoring function when the microphone is connected. Your score is calculated from a scale of 0 to 99 by comparing your voice with the music source.

- 1** Start playing the music.
- 2** Press **SCORE** before singing a song.
- 3** After singing for more than a minute, press **SCORE** again to view your score.

---

## Using the Voice Guidance

You can hear English Voice Guidance on the following situations via the system.

- When entering BLUETOOTH pairing.
- When a BLUETOOTH device is connected.
- When a BLUETOOTH device is disconnected.

**1** Press **OPTIONS**.

**2** Press **▲/▼** repeatedly to select **“VOICE GUIDANCE”**, then press **[+]**.

**3** Press **▲/▼** repeatedly to select **“ON”**, then press **[+]**.

The Voice Guidance is activated. To exit the options menu, press **OPTIONS**.

### Note

- The Voice Guidance and the **SAMPLER** sound effect cannot be output at the same time. If you select **SAMPLER** sound effect while using the Voice Guidance, the Voice Guidance will be stopped automatically, and if you use the Voice Guidance during **SAMPLER** sound effect output, the **SAMPLER** sound effect will stop automatically.
- The Voice Guidance volume level change according to the system's volume level. However, in some cases, the Voice Guidance volume level may not change.
- In some cases, there may be a delay in Voice Guidance output.

---

## Enjoying sound from a guitar

You can listen to the sound from the guitar by connecting a guitar to the **MIC2/GUITAR** jack on the unit. You can also play the guitar and sing along by connecting a microphone to the **MIC1** jack on the unit.

Use the buttons on the unit to perform this operation.

**1** Turn **MIC/GUITAR LEVEL** knob anticlockwise to reduce the guitar volume level.

**2** Use an instrument cable (not supplied) to connect a guitar (not supplied) to **MIC2/GUITAR** jack on the unit.

**3** Press **GUITAR** repeatedly until **GUITAR** indicator lights up.

**4** Start playing the guitar and adjust the guitar volume.

The guitar sound is output from the system.

### Note

- If the guitar sound is distorted, reduce the guitar volume level on your guitar until the distorted sound disappears. If the guitar volume level is too low, turn **MIC/GUITAR LEVEL** knob on the unit clockwise to adjust the guitar volume.
- While playing the guitar, you can adjust the echo effect by pressing **MIC ECHO** repeatedly.

**To turn off the guitar mode**

Press **GUITAR** repeatedly until **GUITAR** indicator lights off.

---

## Enjoying music with the Party Light and Speaker Light

- 1 Press **PARTY LIGHT** repeatedly to select "LED ON".
- 2 Press **LIGHT MODE** repeatedly to select the illumination mode you want.

### To turn off Party Light and Speaker Light

Press **PARTY LIGHT** repeatedly to select "LED OFF".

#### Note

- Do not look directly at the light-emitting part when the Party Light and Speaker Light are turned on.
- If the illumination brightness is glaring, switch on the room lights or turn off the illumination.
- You can turn on or off the Party Light and Speaker Light when demonstration is turned on.

---

## Using the Sleep Timer

The system turns off automatically after the preset time.

### Press **SLEEP** repeatedly to select the time you want.

To cancel Sleep Timer, press **SLEEP** repeatedly to select "OFF".

#### Hint

To check the remaining time before the system turns off, press **SLEEP**.

---

## Using optional equipment

- 1 Press **VOL** – repeatedly until "VOLUME MIN" appears on the display.
- 2 Connect an optional equipment (page 15).
- 3 Press **FUNCTION** repeatedly to select "AUDIO IN".
- 4 Start playing the connected equipment.
- 5 Press **VOL +** repeatedly to adjust the volume.

#### Note

The system may enter standby mode automatically if the volume level of the connected equipment is too low. Adjust the volume level of the equipment. To turn off automatic standby function, see "Setting the automatic standby function" (page 40).

---

## Deactivating the buttons on the unit (Child Lock)

You can deactivate the buttons (except ) on the unit to prevent misoperation, such as child mischief.

### Hold down on the unit for more than 5 seconds.

"CHILD LOCK ON" appears on the display.

You can only operate the system using the buttons on the remote control. To turn off the Child Lock function, hold down ■ on the unit for more than 5 seconds until "CHILD LOCK OFF" appears on the display.

#### Note

- Child Lock function will be turned off automatically when you disconnect the AC power cord (mains lead).
- Child Lock function cannot be activated when you open the disc tray.

---

## Setting the automatic standby function

The system enters standby mode automatically in about 15 minutes when there is no operation or audio signal output.

By default, the automatic standby function is turned on.

**1** Press **OPTIONS**.

**2** Press **▲/▼** repeatedly to select "AUTO STBY", then press **+**.

**3** Press **▲/▼** repeatedly to select "ON" or "OFF", then press **+**.

To exit the options menu, press **OPTIONS**.

#### Note

- "AUTO STBY" flashes on the display about 2 minutes before entering standby mode.
- The automatic standby function does not work in the following cases:
  - during tuner function.
  - when the Sleep Timer is activated.
  - when microphone or guitar is connected.

---

## Updating the software

The software of this system may be updated in the future.

You can update your system's pre-installed software from the websites below.

Follow the online instructions to update the software.

**For customers in the United States:**

<<https://esupport.sony.com/US/>>

**For customers in Canada:**

<<http://esupport.sony.com/CA/>>

## Additional Information

### Troubleshooting

Should you encounter a problem with your system, find your problem in the troubleshooting checklist below and take the corrective action.

If the problem persists, consult your nearest Sony dealer.

Note that if the service personnel changes some parts during repair, these parts may be retained.

#### If "PROTECT XX" (X is a number) appears on the display

Immediately unplug the AC power cord (mains lead), and check the following items.

- Are you using only the supplied speakers?
- Is anything blocking the ventilation holes of the unit?

After you have checked and found no problems, reconnect the AC power cord (mains lead), and turn on the system. If the issue persists, contact your nearest Sony dealer.

#### General

##### The power does not turn on.

- Check that the AC power cord (mains lead) is connected securely.

##### The system has entered standby mode.

- This is not a malfunction. The system enters standby mode automatically in about 15 minutes when there is no operation or audio signal output (page 40).

##### There is no sound.

- Adjust the volume.
- Check the speaker connections (page 16).
- Check the connection of the optional equipment, if any (page 15).
- Turn on the connected equipment.
- Unplug the AC power cord (mains lead), then plug in the AC power cord (mains lead) again and turn on the system.

##### There is no microphone sound.

- Adjust the microphone volume level.
- Make sure the microphone is connected to the MIC1 or MIC2/ GUITAR jack on the unit correctly.
- Make sure the microphone is turned on.

##### There is severe hum or noise.

- Move the system away from sources of noise.
- Connect the system to a different wall outlet.
- Install a noise filter (not supplied) to the AC power cord (mains lead).
- Turn off surrounding electrical equipment.
- The noise generated by the cooling fans of the system may be heard when the system is turned on. This is not a malfunction.
- Move the unit away from the neon signs or fluorescent light.

### **The remote control does not function.**

- Remove the obstacles between the remote control and the unit.
- Move the remote control closer to the unit.
- Point the remote control at the unit's sensor (page 17).
- Replace the batteries (R03/size AAA).
- Move the unit away from the fluorescent light.

### **There is acoustic feedback.**

- Reduce the volume.
- Move the microphone and guitar away from the system or change the direction of the microphone.

### **"PLEASE CONNECT ALL SPK" appears.**

- Check that all speakers are connected.

### **"CHILD LOCK" appears when you press any button on the unit.**

- Set the Child Lock function to off (page 39).

### **A clicking sound is heard when turning the power on.**

- This is the operating sound and it occurs when the power is turned on or off, for example. This is not a malfunction.

## **Speakers**

---

### **Sound comes from only one channel or the left and right volume is unbalanced.**

- Place the speakers as symmetrically as possible.
- Check that the speakers are connected securely and correctly.
- The source being played back is monaural.

### **There is no sound from a specific speaker.**

- Check that the speaker is connected securely and correctly.

## **Disc player**

---

### **The disc tray does not open and "LOCKED" appears on the display.**

- Consult your nearest Sony dealer or local authorized Sony service facility.

### **The disc tray does not close.**

- Load the disc correctly.

### **The disc does not eject.**

- You cannot eject the disc during Synchronized Transfer or REC1 Transfer. Press **■** to cancel the transfer, then press **▲** on the unit to eject the disc.
- Consult your nearest Sony dealer.

### **Playback does not start.**

- Wipe the disc clean (page 47).
- Reload the disc.
- Load the disc that this system can play back (page 8).
- Remove the disc and wipe away the moisture on the disc, then leave the system turned on for a few hours until the moisture evaporates.

### **The sound skips.**

- Wipe the disc clean (page 47).
- Reload the disc.
- Move the unit to a place with no vibration.
- Move the speakers away from the unit. When you listen to a track with bass sounds at high volume, the speaker vibration may cause the sound to skip.

**Playback does not start from the first track.**

- Set the play mode to Normal Play (page 20).
- Resume Play has been selected. Press ■ twice. Then, press ► to start playback.

**The MP3 disc cannot be played back.**

- The data is not stored in the supported format.

**The folder name, track name, file name and ID3 tag characters do not appear properly.**

- The ID3 tag is not Version 1 (1.0/1.1) or Version 2 (2.2/2.3).
- The character codes that can be displayed by this system are as follows:
  - Upper cases (A to Z)
  - Numbers (0 to 9)
  - Symbols (<>\*+,[]\ \_)
  - Other characters appear as “\_”.

**The sound loses stereo effect when you play back an AUDIO CD or audio file.**

- Turn off the Vocal Fader (page 37).
- Make sure the system is connected properly.
- Check the speaker connections (page 16).

**USB device**

---

**Transferring results in an error.**

- You are using an unsupported USB device. Check the information on the website about compatible USB devices (page 10).
- The USB device is not formatted correctly. Refer to the operating instructions of the USB device on how to format.

- Turn off the system and remove the USB device. If the USB device has a power switch, turn the USB device off and on again after removing it from the system. Then, perform the transfer again.
- If the transfer and erase operations are repeated multiple times, the file structure within the USB device becomes fragmented. Refer to the operating instructions of the USB device on how to deal with this problem.
- The USB device was disconnected or the power was turned off during transfer. Delete the partially-transferred file, and perform the transfer again. If this does not fix the problem, the USB device may be broken. Refer to the operating instructions of the USB device on how to deal with this problem.

**Audio files or folders on the USB device cannot be erased.**

- Check if the USB device is write-protected.
- The USB device was disconnected or the power was turned off during the erase operation. Delete the partially-erased file. If this does not fix the problem, the USB device may be broken. Refer to the operating instructions of the USB device on how to deal with this problem.

**There is no sound.**

- The USB device is not connected correctly. Turn off the system and reconnect the USB device, then turn on the system and check if “USB” appears on the display.



### **There is noise, skipping, or distorted sound.**

- You are using an unsupported USB device. Check the information on the website about compatible USB devices (page 10).
- Turn off the system and reconnect the USB device, then turn on the system.
- The music data itself contains noise, or the sound is distorted. Noise may have entered during the transfer process. Delete the file, and try transfer again.
- The bit rate used in encoding an audio file was low. Send an audio file with higher bit rate to the USB device.

### **“READING” is displayed for an extended time, or it takes a long time before playback starts.**

- The reading process can take a long time in the following cases.
  - There are many folders or files on the USB device (page 9).
  - The file structure is extremely complex.
  - The memory capacity is excessive.
  - The internal memory is fragmented.

### **“NO FILE” appears on the display.**

- The system has entered the software update mode, and all buttons (except ) are deactivated. Press  on the unit to cancel the software update.

### **“OVER CURRENT” appears on the display.**

- A problem has been detected with the level of electrical current from the  (USB) port. Turn off the system and remove the USB device from the port. Make sure there is no problem with the USB device. If this display pattern persists, contact your nearest Sony dealer.

### **Erroneous display.**

- The data stored in the USB device may have been corrupted, perform the transfer again.
- The character codes that can be displayed by this system are as follows:
  - Upper cases (A to Z)
  - Numbers (0 to 9)
  - Symbols (< > \* +, [ ] \ \_)Other characters appear as “\_”.

### **The USB device is not recognized.**

- Turn off the system and reconnect the USB device, then turn on the system.
- Check the information on the website about compatible USB devices (page 10).
- The USB device is not working properly. Refer to the operating instructions of the USB device on how to deal with this problem.

### **Playback does not start.**

- Turn off the system and reconnect the USB device, then turn on the system.
- Check the information on the website about compatible USB devices (page 10).

### **Playback does not start from the first file.**

- Set the play mode to Normal Play (page 20).

**Files cannot be played back.**

- USB devices formatted with file systems other than FAT16 or FAT32 are unsupported.\*
- If you use a partitioned USB device, only files on the first partition can be played back.

\* This system supports FAT16 and FAT32, but some USB devices may not support all of these FAT. For details, refer to the operating instructions of each USB device or contact the manufacturer.

**Tuner\***

---

**There is severe hum or noise, or stations cannot be received.**

- Connect the antenna properly.
- Change antenna location and its orientation to obtain good reception.
- Turn off nearby electrical equipment.

\* Radio may not be received depending on the radio wave conditions or the housing environment in your area.

**BLUETOOTH device**

---

**Pairing cannot be performed.**

- Move the BLUETOOTH device closer to the system.
- Pairing may not be possible if other BLUETOOTH devices are present around the system. In this case, turn off the other BLUETOOTH devices.
- Make sure to enter the correct passkey when selecting the system's name (this system) on the BLUETOOTH device.

**The BLUETOOTH device cannot detect the system, or "BT OFF" appears on the display.**

- Set the BLUETOOTH signal to "BT ON" (page 30).

**Connection is not possible.**

- The BLUETOOTH device you attempted to connect does not support the A2DP profile, and cannot be connected with the system.
- Enable the BLUETOOTH function of the BLUETOOTH device.
- Establish a connection from the BLUETOOTH device.
- The pairing registration information has been erased. Perform the pairing operation again.
- Erase the pairing registration information of the BLUETOOTH device (page 27) and perform the pairing operation again (page 26).

**The sound skips or fluctuates, or the connection is lost.**

- The system and the BLUETOOTH device are too far apart.
- If there are obstacles between the system and your BLUETOOTH device, remove or avoid the obstacles.
- If there is equipment that generates electromagnetic radiation, such as a wireless LAN, other BLUETOOTH device, or a microwave oven nearby, move them away.

**The sound of your BLUETOOTH device cannot be heard on this system.**

- Increase the volume on your BLUETOOTH device first, then adjust the volume using VOL +/-.

**There is severe hum, noise, or distorted sound.**

- If there are obstacles between the system and your BLUETOOTH device, remove or avoid the obstacles.

- If there is equipment that generates electromagnetic radiation, such as a wireless LAN, other BLUETOOTH device, or a microwave oven nearby, move them away.
- Turn down the volume of the connected BLUETOOTH device.

## Party Chain

### Party Chain function cannot be activated.

- Check the connections (page 34).
- Make sure the audio cables are connected correctly.

### “PARTY CHAIN” is flashing on the display.

- You cannot select AUDIO IN function if you make connection **A** (page 34) during Party Chain function. Select other function (page 36).
- Press PARTY CHAIN on the unit.
- Restart the system.

### Party Chain function does not work properly.

- Turn off the system. Then, turn it back on again to activate the Party Chain function.

## Resetting the system

If the system still does not operate properly, reset the system to factory default settings.

Use the buttons on the unit to perform this operation.

- 1 Unplug the AC power cord (mains lead), then plug it back in.
- 2 Press  to turn on the system.

- 3 Hold down DJ OFF and  for about 3 seconds.

“RESET” appears on the display.

After the reset completes, the system automatically reboots. Press  to turn on the system.

All user-configured settings, such as preset radio stations are reset to factory default setting.

## Messages

One of the following messages may appear or flash on the display during operation.

### CANNOT PLAY

A disc that cannot be played back was inserted.

### DATA ERROR

- The file is created in unsupported format.
- The file extensions does not match the file format.

### DEVICE ERROR

The USB device could not be recognized or an unknown device is connected.

### DEVICE FULL

The memory of the USB device is full.

### ERASE ERROR

Erase of audio files or folders on the USB device failed.

### FATAL ERROR

The USB device was removed during transfer or erase operation, and may have been damaged.

### FOLDER FULL

You cannot transfer onto the USB device because the number of folders has reached its maximum.

**GUEST**

The system has become a Party Guest as the Party Chain function has been activated by a Party Host.

**HOST**

The system activated the Party Chain function and has become a Party Host.

**NO DEVICE**

No USB device is connected or unsupported device is connected.

**NO DISC**

There is no disc in the unit.

**NO MUSIC**

No supported audio files exist in the playback source.

**NOT IN USE**

You tried to perform a specific operation under conditions where that operation is prohibited.

**NOT SUPPORTED**

An unsupported USB device is connected, or the USB device is connected through a USB hub.

**OVER CURRENT**

An over current from the  (USB) port was detected.

**PROTECTED**

The USB device is write-protected.

**PUSH STOP**

You tried to perform an operation that can be performed only when the playback is stopped.

**READING**

The system is reading information of the disc or USB device. Some operations are not available.

**REC ERROR**

The transfer did not start, stopped partway, or otherwise could not be performed.

**TRACK FULL**

You cannot transfer onto the USB device because the number of files has reached its maximum.



---

## Precautions

**When carrying the unit**

To avoid damaging the disc mechanism, perform the following procedure before carrying the unit.

Use the buttons on the unit to perform this operation.

- 1 Press  to turn on the system.
- 2 Press **FUNCTION** repeatedly to select "CD".
- 3 Remove the disc.  
Press  to open and close the disc tray.  
Wait until "NO DISC" appears on the display.
- 4 Unplug the AC power cord (mains lead).

**Notes on discs**

- Before playing, wipe the disc with a cleaning cloth from the center outward to the edge.
- Do not clean discs with solvents, such as benzene, thinner, or commercially available cleaners or anti-static spray intended for vinyl LPs.
- Do not expose discs to direct sunlight or heat sources such as hot air ducts, nor leave them in a car parked in direct sunlight.

### On safety

- Completely disconnect the AC power cord (mains lead) from the wall outlet (mains) if it is not going to be used for an extended period of time. When unplugging the unit, always grip the plug. Never pull the cord itself.
- Should any solid object or liquid get into the system, unplug the system, and have it checked by qualified personnel before operating it again.
- AC power cord (mains lead) must be changed only at the qualified service shop.

### On handling the system

This system is not drip-proof or waterproof. Make sure not to splash water on the system or clean it with water.

### On placement

- Do not place the system in an inclined position or in locations that are extremely hot, cold, dusty, dirty, or humid or lacking adequate ventilation, or subject to vibration, direct sunlight or a bright light.
- Be careful when placing the unit or speakers on surfaces that have been specially treated (for example, wax, oil, polish) as staining or discoloration of the surface may result.
- If the system is brought directly from a cold to a warm location or is placed in a very damp room, moisture may condense on the lens inside the unit, and cause the system to malfunction. In this situation, remove the disc, and leave the system turned on for about an hour until the moisture evaporates.

### On heat buildup

- Heat buildup on the unit during operation is normal and is not a cause for alarm.
- Do not touch the cabinet if it has been used continuously at a high volume because the cabinet may have become hot.
- Do not obstruct the ventilation holes.

### On the speaker system

The speaker system is not magnetically shielded, and the picture on nearby TV sets may become magnetically distorted. In this situation, turn off the TV, wait 15 to 30 minutes, and turn it back on. If there is no improvement, move the speakers far away from the TV.

### Cleaning the cabinet

Clean this system with a soft cloth slightly moistened with a mild detergent solution. Do not use any type of abrasive pad, scouring powder, or solvent, such as thinner, benzene, or alcohol.

### On BLUETOOTH communication

- BLUETOOTH devices should be used within approximately 10 meters (33 feet) (unobstructed distance) of each other. The effective communication range may become shorter under the following conditions:
  - When a person, metal object, wall or other obstruction is between the devices with a BLUETOOTH connection
  - Locations where a wireless LAN is installed
  - Around microwave ovens that are in use
  - Locations where other electromagnetic waves are generated
- BLUETOOTH devices and wireless LAN (IEEE 802.11b/g/n) equipment use the same frequency band (2.4 GHz). When using your BLUETOOTH device near a device with wireless LAN capability, electromagnetic interference may occur. This could result in lower data transfer rates, noise, or inability to connect. If this happens, try the following remedies:
  - Use this system at least 10 meters (33 feet) away from the wireless LAN equipment.
  - Turn off the power of the wireless LAN equipment when using your BLUETOOTH device within 10 meters (33 feet).

- Use this system and BLUETOOTH device as close to each other as possible.
- The radio waves broadcast by this system may interfere with the operation of some medical devices. Since this interference may result in malfunction, always turn off the power on this system and BLUETOOTH device in the following locations:
  - In hospitals, on trains, in airplanes, at gas stations, and any place where flammable gases may be present
  - Near automatic doors or fire alarms
- This system supports security functions that comply with BLUETOOTH specifications to ensure secure connections during communication using BLUETOOTH technology. However, this security may be insufficient depending on the setting contents and other factors, so always be careful when performing communication using BLUETOOTH technology.
- Sony cannot be held liable in any way for damages or other loss resulting from information leaks during communication using BLUETOOTH technology.
- BLUETOOTH communication is not necessarily guaranteed with all BLUETOOTH devices that have the same profile as this system.
- BLUETOOTH devices connected with this system must comply with the BLUETOOTH specification prescribed by the Bluetooth SIG, Inc., and must be certified to comply. However, even when a device complies with the BLUETOOTH specification, there may be cases where the characteristics or specifications of the BLUETOOTH device make it impossible to connect, or may result in different control methods, display or operation.
- Noise may occur or the audio may cut off depending on the BLUETOOTH device connected with this system, the communications environment, or surrounding conditions.

---

## Specifications

### AUDIO POWER SPECIFICATIONS

#### POWER OUTPUT AND TOTAL HARMONIC DISTORTION: (USA models only)

##### SHAKE-X30 only

With 4 ohm loads, both channels driven, from 150 Hz – 20,000 Hz; rated 90 watts per channel minimum RMS power, with no more than 0.7% total harmonic distortion from 250 milliwatts to rated output.

##### SHAKE-X10 only

With 4 ohm loads, both channels driven, from 150 Hz – 20,000 Hz; rated 80 watts per channel minimum RMS power, with no more than 0.7% total harmonic distortion from 250 milliwatts to rated output.

### Inputs

AUDIO/PARTY CHAIN IN L/R:

Voltage 2 V, impedance  
47 kilohms

MIC1:

Sensitivity 1 mV, impedance  
10 kilohms

MIC2/GUITAR:

Sensitivity 1 mV, impedance  
10 kilohms (When guitar mode is  
turned off.)

Sensitivity 200 mV, impedance  
1 Megaohm (When guitar mode is  
turned on.)

### Outputs

AUDIO/PARTY CHAIN OUT L/R:

Voltage 2 V, impedance 1 kilohm

## Disc player section

### System:

Compact disc and digital audio system

### Laser Diode Properties

Emission Duration: Continuous

Laser Output\*: Less than 44.6  $\mu\text{W}$

\* This output is the value measurement at a distance of 200 mm from the objective lens surface on the Optical Pick-up Block with 7 mm aperture.

### Frequency response:

20 Hz – 20 kHz

## USB section

### Supported USB device:

Mass Storage Class

### Maximum current:

1 A

### ↔ (USB) port:

Type A

## FM tuner section

FM stereo, FM superheterodyne tuner

### Antenna:

FM lead antenna

### Tuning range:

87.5 MHz – 108.0 MHz (100 kHz step)

## BLUETOOTH section

### Communication system:

BLUETOOTH Standard version 3.0

### Output:

BLUETOOTH Standard Power  
Class 2

### Maximum communication range:

Line of sight approx. 10 m (33 ft)\*1

### Frequency band:

2.4 GHz band (2.4000 GHz – 2.4835 GHz)

### Modulation method:

FHSS (Freq Hopping Spread Spectrum)

### Compatible BLUETOOTH profiles\*2:

A2DP (Advanced Audio Distribution Profile)  
AVRCP (Audio Video Remote Control Profile)  
SPP (Serial Port Profile)

### Supported codecs:

SBC (Subband Codec)  
AAC (Advanced Audio Coding)  
LDAC

\*1 The actual range will vary depending on factors such as obstacles between devices, magnetic fields around a microwave oven, static electricity, reception sensitivity, antenna's performance, operating system, software application, etc.

\*2 BLUETOOTH standard profiles indicate the purpose of BLUETOOTH communication between devices.

## Supported audio formats

Supported bit rate and sampling frequencies:

MP3:

32/44.1/48 kHz, 32 kbps – 320 kbps (VBR)

AAC:

44.1 kHz, 48 kbps – 320 kbps (CBR/VBR)

WMA:

44.1 kHz, 48 kbps – 192 kbps (CBR/VBR)

WAV:

44.1/48 kHz (16 bit)

## Speaker System

### SS-SHAKE30

#### Speaker system:

2-way, Sound Pressure Horn

#### Speaker unit:

Tweeters: 25 mm (1 in), horn type  
Subwoofers: 250 mm (9 7/8 in), cone type

#### Rated impedance:

4 ohms

Dimensions (w/h/d) (Approx.):  
368 mm × 585 mm × 391 mm  
(14 1/2 in × 23 1/8 in × 15 1/2 in)  
Mass (Approx.):  
16.1 kg (35 lb 8 oz)

## **SS-SHAKE10**

Speaker system:  
2-way, Sound Pressure Horn  
Speaker unit:  
Tweeters: 25 mm (1 in), horn type  
Subwoofers: 200 mm (7 7/8 in),  
cone type  
Rated impedance:  
4 ohms  
Dimensions (w/h/d) (Approx.):  
315 mm × 490 mm × 388 mm  
(12 1/2 in × 19 3/8 in × 15 3/8 in)  
Mass (Approx.):  
12 kg (26 lb 8 oz)

## **General**

Power requirements:  
AC 120 V, 60 Hz  
Power consumption:  
220 W  
Dimensions (w/h/d) (excl. speakers)  
(Approx.):  
455 mm × 165 mm × 330 mm  
(18 in × 6 1/2 in × 13 in)  
Mass (excl. speakers) (Approx.):  
5.8 kg (12 lb 13 oz)

Design and specifications are subject  
to change without notice.