

G604

SETUP GUIDE
GUIDE D'INSTALLATION



logitech ™

SETUP INSTRUCTIONS

1 Remove the battery cover by lifting upward the back of the cover.

1

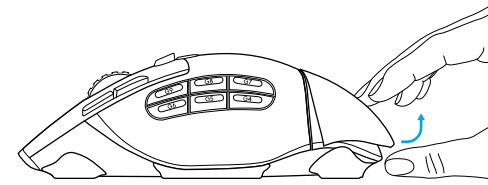

2 Insert the battery.

2

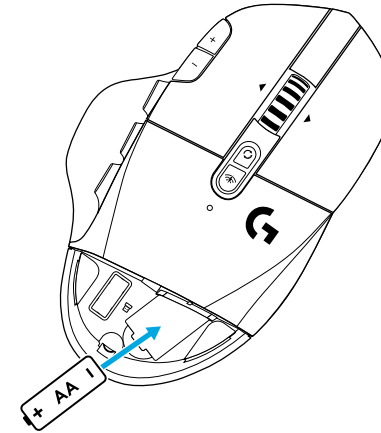

3 Remove the receiver.

3

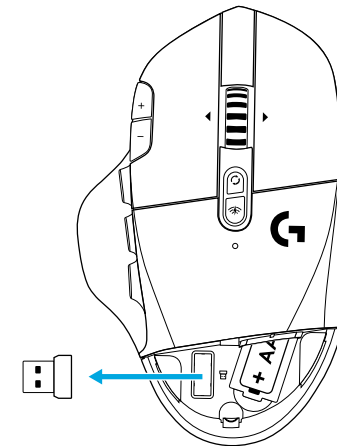

4 Close the battery cover.

4

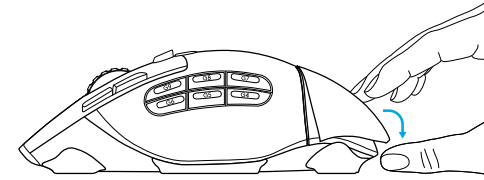

5 Make sure the switch on the bottom of the mouse is in the on position.

5

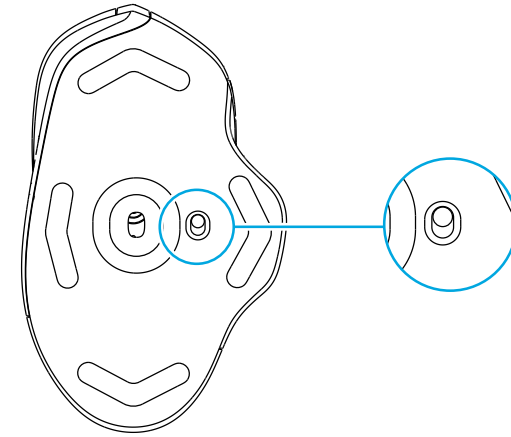

6 Recommended: Insert receiver into the receiver extension cable. Insert extension cable into your USB port. Alternatively, insert receiver directly into your USB port.

6

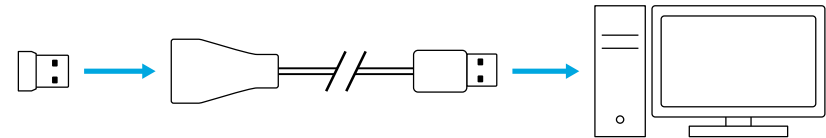

7 (Optional) Download Logitech G HUB software to access advanced features. Download at logitechG.com/ghub

7

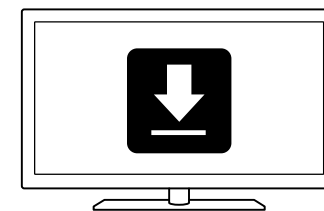

Tips:

- To make your mouse lighter, a lithium AA battery (not included) can be used.
- G604 has a wireless range of up to 10 meters. To ensure optimal performance in noisy wireless environments, it is recommended to keep the receiver within 20 cm of the mouse.
- Keep the mouse and receiver 2 m+ away from wireless routers or other 2.4 GHz wireless devices to minimize environmental noise.

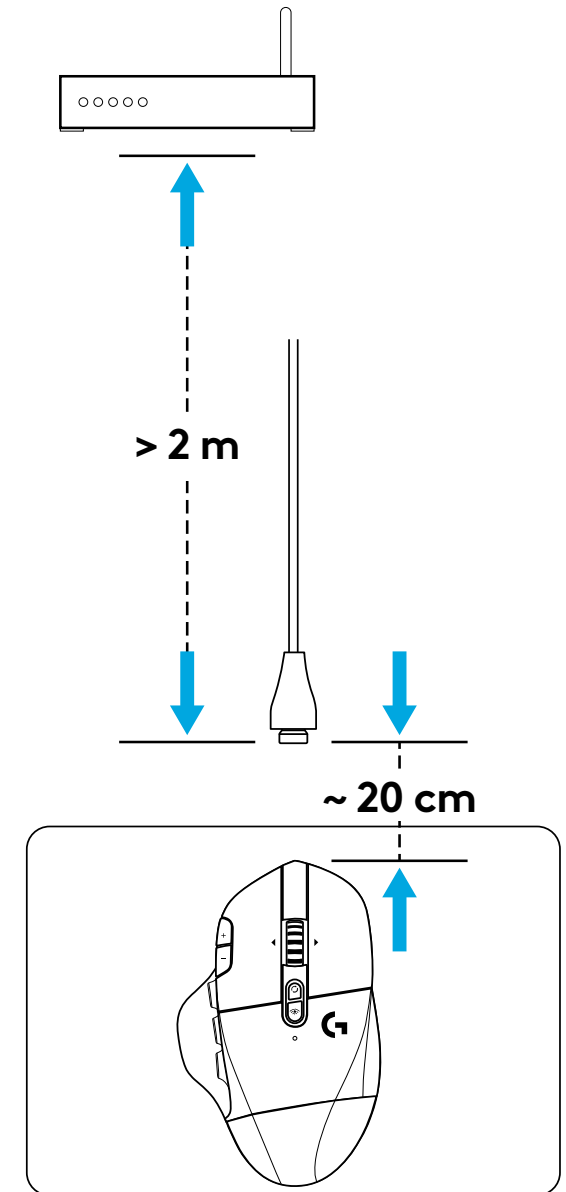
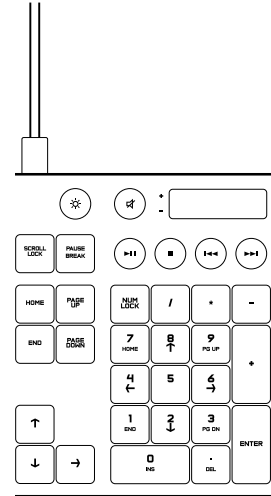

15 FULLY PROGRAMMABLE CONTROLS

- 1 Main click
- 2 Secondary click
- 3 Wheel click
- 4 DPI up
- 5 DPI down
- 6 Scroll up
- 7 Scroll right
- 8 Scroll down
- 9 Scroll left
- 10 Button G4 - Default: DPI shift
- 11 Button G5 - Default: Backward
- 12 Button G6 - Default: Forward
- 13 Button G7 - Default: 3
- 14 Button G8 - Default: 2
- 15 Button G9 - Default: 1

Programmable controls can be changed using Logitech G HUB software.

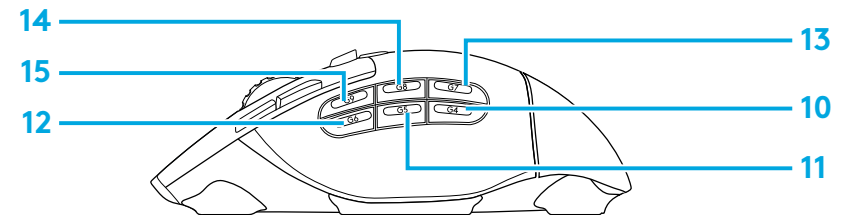
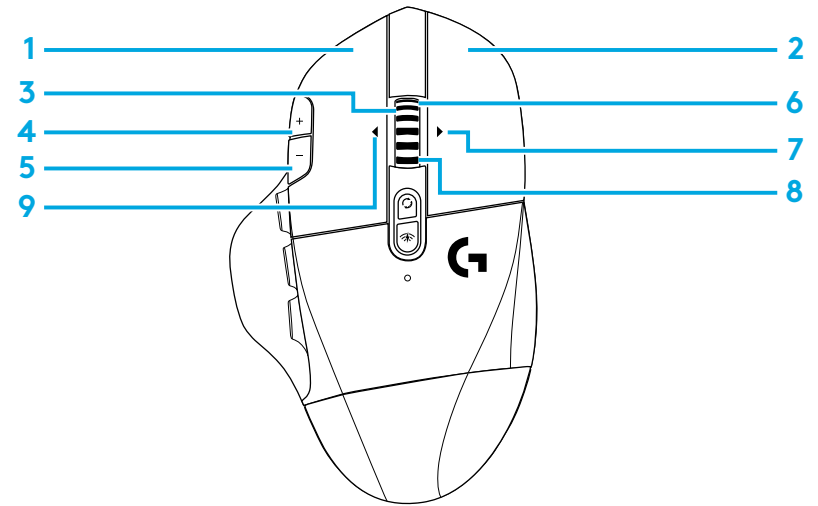

NON-PROGRAMMABLE CONTROLS

- 16 Wheel mode toggle button
- 17 LIGHTSPEED / Bluetooth toggle button
- 18 ON/OFF button

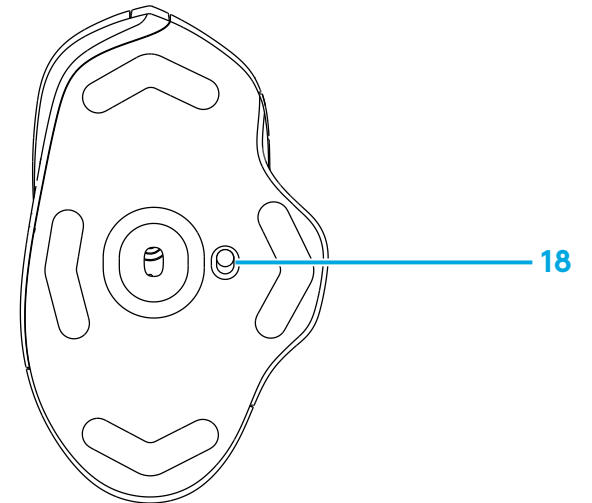
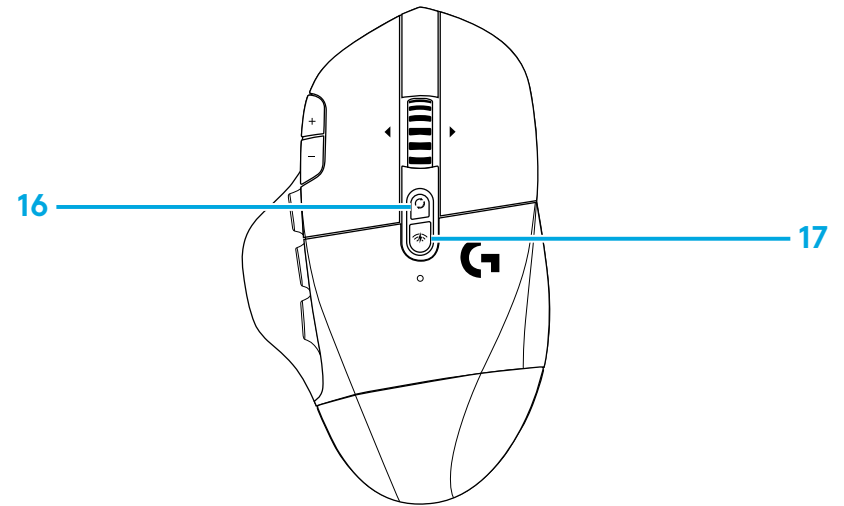

BLUETOOTH® / LIGHTSPEED DUAL CONNECTIVITY

Out of the box, your mouse and LIGHTSPEED receiver are paired.

To pair to a *Bluetooth*-enable computer:

Step 1: Press the connectivity button for 5 seconds until the LED indicator flashes blue quickly.

Step 2: Go to the *Bluetooth* settings of your computer

Step 3: Click “Add a *Bluetooth* Device” and select “G604 Gaming Mouse”

The color of the LED indicator will turn solid blue for 5 seconds when your mouse and computer are successfully paired.

To toggle between a *Bluetooth* and LIGHTSPEED mode, press the connectivity button for 0.2 sec, but less than 5 sec.

Tips:

- To pair your mouse to another *Bluetooth*-enable computer, repeat steps 1 to 3.
- *Bluetooth* mode has lower report rate compared to LIGHTSPEED. In *Bluetooth* mode, G604 has longer battery life as well.

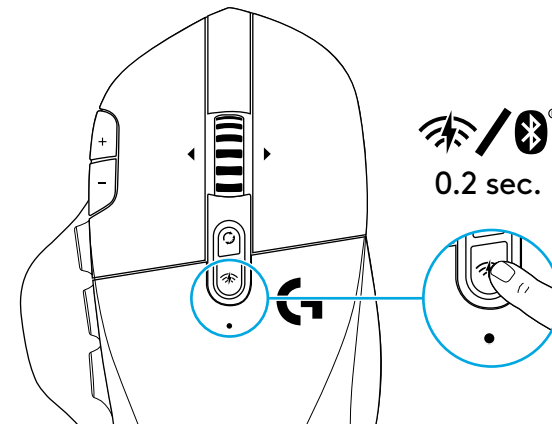
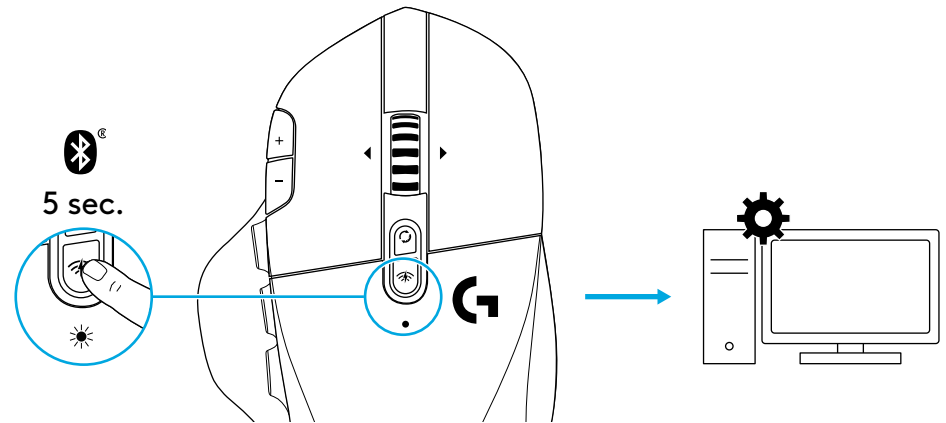

LED INDICATOR

Battery life

Flashing red: battery <15%

DPI steps

Yellow: step 1 (default)

White: step 2 (default)

Orange: step 3 (default)

Magenta: step 4 (default)

Purple: step 5 (Step 5 can be activated via software only)

Mode

Cyan (solid): LIGHTSPEED mode (default)

Cyan (slow flashing): Mouse looking for previously paired LIGHTSPEED receiver

Blue (solid): *Bluetooth* mode, mouse paired

Blue (fast flashing): *Bluetooth* pairing mode

Blue (slow flashing): Mouse looking for previously paired *Bluetooth* device

LOGITECH G HUB SOFTWARE

You can customize the onboard profile settings using the Logitech G HUB Software. These settings include button programming, report rate and tracking behavior. G604 allows up to 5 onboard DPI settings.

By default, G604 has the following settings:

- DPI: 400/800(default)/1600/3200
- DPI Shift: 400
- Report rate: 1 ms

QUESTIONS?

logitechG.com/support/g604