

# IN3924, IN3926

User's Guide  
Mode d'emploi  
Benutzeranleitung  
Manuale d'uso  
Manual de Uso  
Guia do Usuário  
Gebruikershandleiding

Användarhandbok  
Brukerhåndbok  
Руководство по пользователю  
사용 설명서  
用戶指南  
Panduan Pengguna  
دليل المستخدم

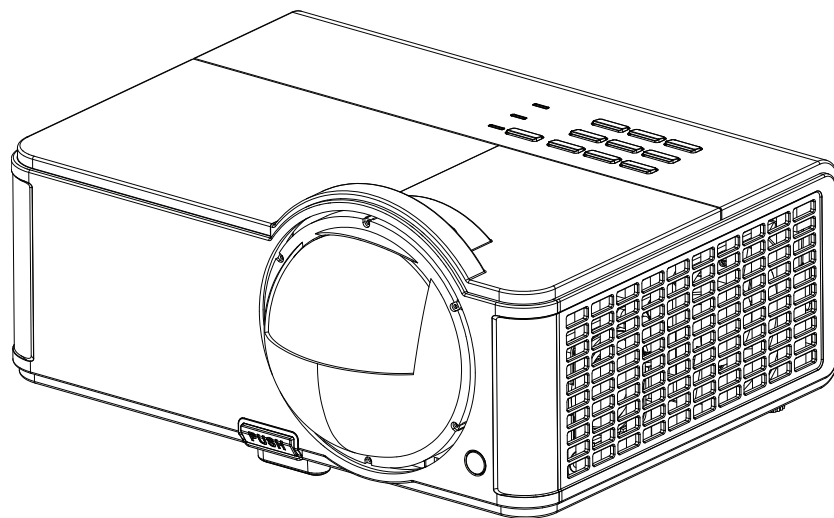

## Declaration of Conformity

Manufacturer: InFocus Corporation, 13190 SW 68th Parkway, Suite 200, Portland, Oregon 97223-8368 USA

We declare under our sole responsibility that this projector conforms to the following directives and norms:

ErP Directive 2009/125/EC

EMC Directive 2004/108/EC

EMC: EN 55024:2010, EN 55022:2010, EN 61000-3-2:2006+A1:2009+A2:2009, EN 61000-3-3:2008

Low Voltage Directive 2006/95/EC

Safety: IEC 60950-1: 2005;EN 60950-1:2006 +A11:2009

R&TTE Directive: 1999/5/EC

ETSI: EN 300 440, EN 301 489

The receiver portion of this product is a Category III device, as specified in EN 300 440.

## Trademarks

Apple, Macintosh, and PowerBook are trademarks or registered trademarks of Apple Computer, Inc. IBM is a trademark or registered trademark of International Business Machines, Inc. Microsoft, PowerPoint, and Windows are trademarks or registered trademarks of Microsoft Corporation. Adobe and Acrobat are trademarks or registered trademarks of Adobe Systems Incorporated. DLP®, DLP Link and the DLP logo are registered trademarks of Texas Instruments and BrilliantColor™ is a trademark of Texas Instruments. InFocus, In Focus, and INFOCUS (stylized) are either registered trademarks or trademarks of InFocus Corporation in the United States and other countries.

**NOTE:** This product is covered electrical and electronic equipment under the European Union's Waste from Electrical and Electronic Equipment ("WEEE") Directive (2002/96/EC). The WEEE Directive requires that covered equipment be collected and managed separately from typical household waste in all EU member states. Please follow the guidance of your local environmental authority or ask the shop where you purchased the product for collection or recycling options.



## FCC Warning

This device complies with part 15 of the FCC Rules. Operation is subject to the following two conditions: (1) This device may not cause harmful interference, and (2) this device must accept any interference received, including interference that may cause undesired operation.

Note: This equipment has been tested and found to comply with the limits for a Class B digital device, pursuant to part 15 of the FCC Rules. These limits are designed to provide reasonable protection against harmful interference in a residential installation. This equipment generates, uses and can radiate radio frequency energy and, if not installed and used in accordance with the instructions, may cause harmful interference to radio communications. However, there is no guarantee that interference will not occur in a particular installation. If this equipment does cause harmful interference to radio or television reception, which can be determined by turning the equipment off and on, the user is encouraged to try to correct the interference by one or more of the following measures:

--Reorient or relocate the receiving antenna.

--Increase the separation between the equipment and receiver.

--Connect the equipment into an outlet on a circuit different from that to which the receiver is connected.

--Consult the dealer or an experienced radio/TV technician for help.

Changes or modifications not expressly approved by InFocus Corporation may void authority to operate the equipment.

## CE Warning

This product is considered Class A for EU market.

## Canada

This Class B digital apparatus complies with Canadian ICES-003. Cet appareil numérique de la classe B est conforme à la norme NMB-003 du Canada.

This device complies with RSS-210 of the Industry Canada Rules.

Operation is subject to the following two conditions:

1) this device may not cause interference and

2) this device must accept any interference, including interference that may cause undesired operation of the device.

Ce dispositif est conforme à la norme CNR-210 d'Industrie Canada applicable aux appareils radio exempts de licence. Son fonctionnement est sujet aux deux conditions suivantes:

(1) le dispositif ne doit pas produire de brouillage préjudiciable, et

(2) ce dispositif doit accepter tout brouillage reçu, y compris un brouillage susceptible de provoquer un fonctionnement indésirable.

## Agency Approvals

cULus

Other specific Country Approvals may apply. Please see product certification label.

This document applies to regulatory model IN3924/IN3926.

Input ratings: 100-240Vac, 3.2A, 50-60Hz

InFocus reserves the right to alter product offerings and specifications at any time without notice.

## Table of Contents

Introduction	5
Positioning the projector	7
Connecting a computer source	8
VGA connection	8
HDMI connection	8
Connecting power	8
Optional computer connections	8
Displaying an image	9
Adjusting the image	10
Connecting a video device	11
Video device connections	11
Composite video connection	11
VGA connection	11
Component video connection	11
S-video connection	11
Shutting down the projector	12
Troubleshooting your setup	12
Using the remote control	20
Using the audio	21
Using the keypad buttons	22
Optimizing computer images	23
Presentation features	23
Optimizing video images	24
Customizing the projector	24
Using the menus	25
Basic Menu	26
Advanced Menu	27
Controlling the projector through a LAN environment	31
Controlling the projector remotely through a web browser	32
Displaying images through iFPresenter	36
Displaying pictures with a USB storage device	39
LiteBoard™ Wand	41
Charging the Wand's Battery	41
How to Use the Wand	41
Wand Position and Avoiding Shadows	41
Using More than One Wand	42

Wand Features	43
Buttons and Wand Tip	43
Troubleshooting LiteBoard™	44
Maintenance	45
Cleaning the lens	45
Using the security lock	45
Replacing the projection lamp	46

## Important Operating Considerations for Safety

- Refer to this guide for proper startup and shutdown procedures.
- Follow all warnings and cautions in this manual and on the projector.
- Place the projector in a horizontal position no greater than 15 degrees off axis.
- Locate the projector at least 4' (1.2m) away from any heating or cooling vents.
- Do not block ventilation openings. Locate the projector in a well-ventilated area without obstructions to intake or exhaust vents. Do not place the projector on a tablecloth or other soft covering that may block the vents.
- Do not place the projector in direct sunlight, humid, greasy or dusty places or in places where the projector may come into contact with smoke or steam.
- Do not touch or block the projector lens with any objects as this can damage the projector lens. Scratches, gouges and other lens damage are not covered by the product warranty.
- Do not look directly into the lens while the projector is being used.
- Do not drop the projector.
- Do not spill liquid on the projector. Spilled liquid may damage the projector.
- Use the power cord provided. Connect the power cord to a receptacle with a protective safety (earth) ground terminal. A surge-protected power strip is recommended.
- Do not overload wall outlets.
- When disconnecting the power cord, hold the plug, not the cord.
- Wash hands after handling the cables supplied with this product.
- The projector remote control uses batteries. Make sure the batteries' polarity (+/-) is aligned correctly. Dispose of used batteries in accordance with local disposal laws.
- Use an InFocus approved ceiling mount kit for proper fitting, ventilation and installation. The warranty does not cover any damage caused by use of non-approved ceiling mount kits or by installing in an improper location.
- When the projector is ceiling mounted, wear protective eyewear to prevent eye injury before opening lamp door.

- Refer all service to qualified service personnel. Servicing your own projector can be dangerous to you and will void the warranty.
- Only use replacement parts specified by InFocus. Unauthorized substitutions may result in fire, electrical shock, or injury, and may void the warranty.
- Only genuine InFocus lamps are tested for use in this projector. Use of non InFocus lamps may cause electrical shock and fire, and may void the projector warranty.
- Hg – Lamp contains mercury. Manage in accordance with local disposal laws. See [www.lamprecycle.org](http://www.lamprecycle.org).
- The projector uses a high-pressure mercury glass lamp. The lamp may fail prematurely, or it may rupture with a popping sound if jolted, scratched, or handled while hot. The risk of lamp failure or rupture also increases as the lamp age increases; please replace the lamp when you see the "Replace Lamp" message.
- In the unlikely event of a lamp rupture, particles may exit through the projector vents. Keep people, food, and drinks out of the "keep out" area under and around the projector, as indicated by the "X" areas below.

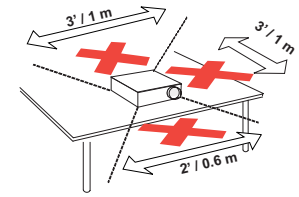
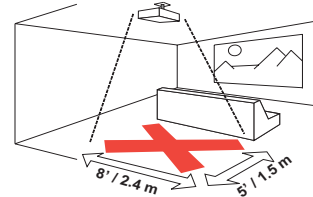

- Follow these instructions to help ensure image quality and lamp life over the life of the projector. Failure to follow these instructions may affect the warranty. For complete details of the warranty, see the Warranty/Safety booklet.

# Introduction

Your new digital projector is simple to connect, easy to use, and straightforward to maintain. It is a versatile projector that is flexible enough for business presentations and home video viewing too. IN3924 has native XGA 1024 x 768 resolution, and IN3926 has native WXGA 1280 x 800 resolution. It is compatible with a wide variety of computers and video devices.

## Product specifications

To read the latest specifications on your multimedia projector, be sure to visit our website at [www.infocus.com](http://www.infocus.com), as specifications are subject to change.

## Accessories

The standard accessories that came with your projector are listed in the included Quick Start documentation. Optional accessories can be found on our website at [www.infocus.com/support](http://www.infocus.com/support) or at your retailer or dealer.

## Online registration

Register your projector on our website at [www.infocus.com/register](http://www.infocus.com/register) to activate your warranty and receive product updates, announcements, and registration incentives.

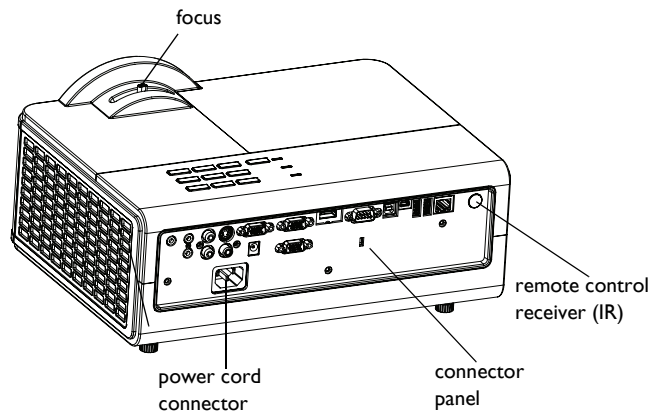
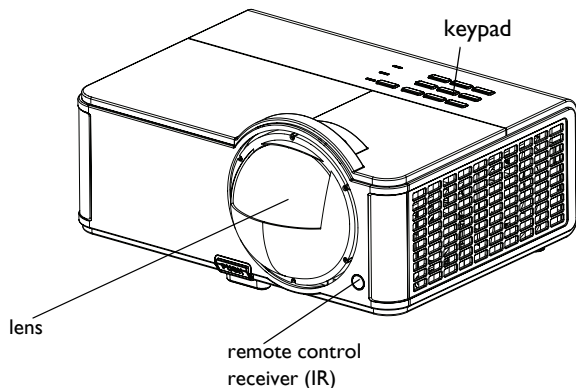

## Connector panel

The projector provides both computer and video connection options, including:

- HDMI
- VGA computer (2)
- S-video
- Composite video
- Monitor out (for external monitors)
- Audio inputs (1 RCA; 2 3.5mm)
- Audio output
- Microphone input
- USB A (2 - for JPEG presentations from a USB flash drive and for connecting a mouse, keyboard or wireless adapter)
- USB mini B (for presentation slide and LiteBoard™ Wand control)
- USB B (for firmware upgrades)
- LAN (RJ45 for network control and video over LAN)
- 12 volt DC output (for screen trigger)
- RS232 (Serial command codes available at [www.infocus.com/support](http://www.infocus.com/support))

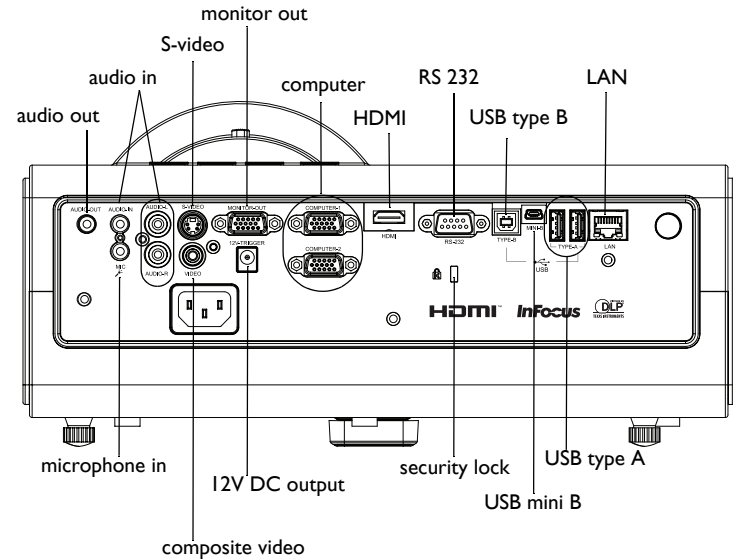

# Positioning the projector

To determine where to position the projector, consider the size and shape of your screen, the location of your power outlets, and the distance between the projector and the rest of your equipment. Here are some general guidelines:

- Position the projector on a flat surface at a right angle to the screen. IN3924 must be at least 45" (1.0m) from the projection screen, and IN3926 must be at least 51" (1.3m) from the projection screen.
- If you are installing the projector on the ceiling, we strongly recommend using InFocus approved ceiling mounts for proper fitting, ventilation and installation. Refer to the installation guide that comes with the InFocus Ceiling Mount Kit (p/n PRJ-MNT-UNIV) for more information. The warranty does not cover any damage caused by use of non-approved ceiling mount kits or by installing in an improper location. To turn the image upside down, see "Ceiling mount" on page 28. We recommend using an InFocus authorized ceiling mount.
- Position the projector the desired distance from the screen. The distance from the lens of the projector to the screen and the video format determine the size of the projected image.
- The image offset for IN3924 is 115% +/-5%. This means that if you have an image 60 inches (1.5 meters) tall from a table-mounted projector, the bottom of the image will be 9 inches (22.9 cm) above the centerline of the lens. The image offset for IN3926 is 113% +/-5%. This means that if you have an image 60 inches (1.5 meters) tall from a table-mounted projector, the bottom of the image will be 7.8 inches (19.8 cm) above the centerline of the lens.

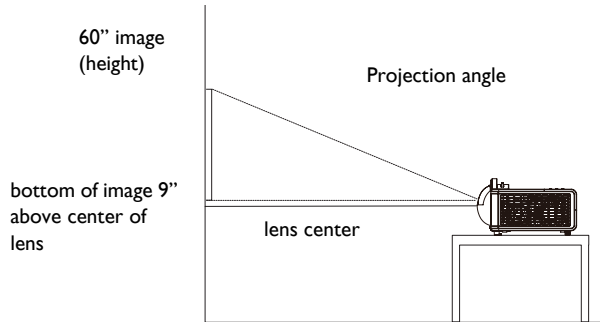
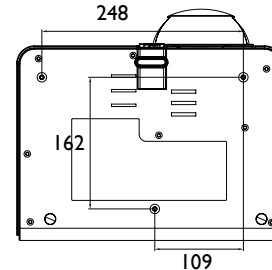

*Table 1: IN3924 (XGA) Screen size*

Diagonal Screen Size (inches/m)	Size of the Projected Image Width (inches/m)	Distance to screen (inches/m)
50"/1.3m	40"/1.0m	19"/0.5m
60"/1.5m	48"/1.2m	23"/0.6m
70"/1.8m	56"/1.4m	27"/0.7m
80"/2.0m	64"/1.6m	31"/0.8m
100"/2.5m	80"/2.0m	38"/1.0m

*Table 2: IN3926 (WXGA) Screen size*

Diagonal Screen Size (inches/m)	Size of the Projected Image Width (inches/m)	Distance to screen (inches/m)
60"/1.5m	51"/1.3m	19"/0.5m
70"/1.8m	59"/1.5m	22"/0.6m
90"/2.3m	76"/1.9m	29"/0.7m
100"/2.5m	85"/2.2m	32"/0.8m
120"/3.1m	102"/2.6m	38"/1.0m



Ceiling mount screws:  
M4x8 (Max. L= 8mm)  
Unit: mm

# Connecting a computer source

## VGA connection

Connect one end of the provided computer cable to the **Computer 1/Computer 2** connector on the projector and the other to the VGA connector on your computer. If you are using a desktop computer, you will need to disconnect the monitor cable from the computer's video port first.

connect VGA cable

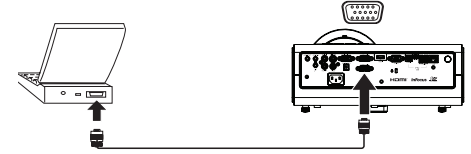

## HDMI connection

HDMI is a standard, uncompressed, all-digital audio/video interface. HDMI provides an interface between sources, such as set-top boxes, DVD players, and receivers and your projector. Plug an HDMI cable into the video-out connector on the video device and into the HDMI connector on the projector.

connect HDMI

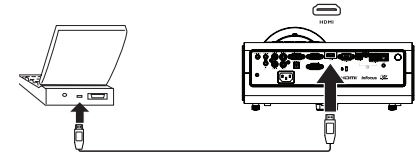

## Connecting power

Connect the black power cord to the **Power** connector on the rear of the projector and to your electrical outlet. If the Power Saving Mode feature is off, the Power LED on the Status Indicator Panel (page 12) blinks orange. If the Power Saving Mode feature is on, the Power LED is steady orange. By default, this feature is off. You can change the setting, see page 29. **NOTE:** Always use the power cord that shipped with the projector.

connect power

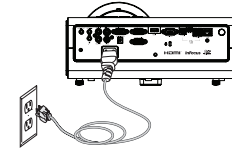

## Optional computer connections

To get sound from the projector, connect an audio cable (optional cable, not included) to your computer and to the **Audio in** connector on the projector. You may also need an adapter.

connect audio cable

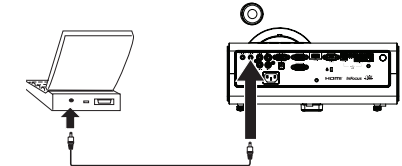

If you are using a desktop computer and want to see the image on your computer screen as well as on the projection screen, connect to the desktop's computer cable to Computer 1 and the desktop's monitor cable to the **Monitor out** connector on the projector.

# Displaying an image

Press the **Power** button.

The Power LED lights orange, and the fans start to run. When the lamp comes on, the start up screen displays. It can take up to a minute for the image to achieve full brightness.

**No start up screen?** Get help on page 13.

Turn on your computer or video device.

The image should appear on the projection screen. If it doesn't, press the **Source** button on the projector's keypad or remote.

**If you are using a VGA cable to connect your computer to the projector:**

If using a laptop, make sure its external video port is active.

Many laptops do not automatically turn on their external video port when a projector is connected. Usually a key combination like FN + F8 or CRT/LCD key turns the external display on and off. Locate a function key labeled CRT/LCD or a function key with a monitor symbol. Press FN and the labeled function key simultaneously.

**Refer to your laptop's documentation for more information about your laptop's key combination.**

**No laptop image?** Try pressing the **Auto** button on the projector's keypad or **Auto Image** button on the remote. Get help on page 13.

press Power button

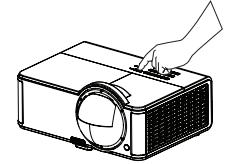

turn on computer or video device

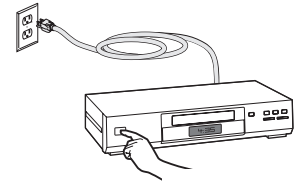

activate laptop's external port



monitor key or  
LCD/CRT key

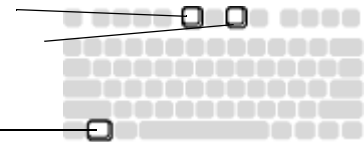

FN key

# Adjusting the image

If necessary, adjust the height of the projector by pressing the elevator foot release button to extend the foot.

If necessary, rotate the leveling feet located at the rear of the projector.

Position the projector the desired distance from the screen at a 90 degree angle to the screen.

See page 7 for a table listing screen sizes and distances.

Adjust the focus.

If the image is not square, first make sure that the projector is perpendicular to the screen. If the image is larger or smaller on the top or bottom edge of the screen, press the top **Keystone** button to reduce the upper part of the image, and press the bottom **Keystone** button to reduce the lower part.

If the left or right side of the screen is larger or smaller the other, you can turn the projector to the left or to the right a few degrees to square the image.

Adjust the Contrast or Brightness in the Basic Menu. See page 26 for help with these menu adjustments.

adjust height

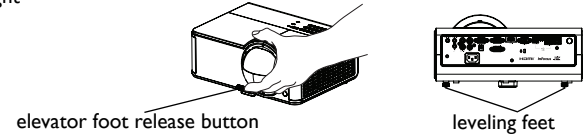

adjust distance

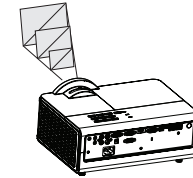

adjust focus

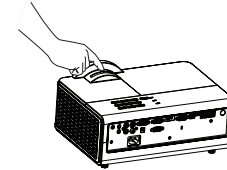

adjust keystone

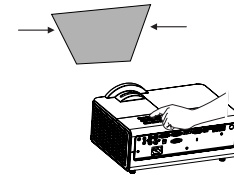

adjust Basic Menu

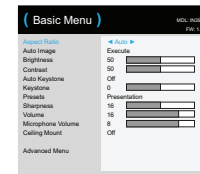

## Connecting a video device

You can connect video devices such as VCRs, DVD players, camcorders, digital cameras, video game consoles, HDTV receivers, and TV tuners to the projector. You can connect the audio directly to the projector to get sound from the built-in speaker, or you can bypass the projector's audio system and connect the audio directly from your source to a stereo or home theater system.

You can connect the projector to most video devices that can output video. You cannot directly connect the coaxial cable that enters your house from a cable or satellite company, the signal must pass through a tuner first. Examples of tuners are digital cable boxes, VCRs, digital video recorders, and satellite TV boxes. Basically, any device that can change channels is considered a tuner.

Before connecting your projector, you should decide which aspect ratio you want to use. The projector's Aspect Ratio setting is accessed through the Resize button on the remote or through the projector's Basic Menu. See page 26 for more information.

## Video device connections

No video cables are provided with the projector. You can order cables from InFocus or provide your own.

### HDMI connection

HDMI is a standard, uncompressed, all-digital audio/video interface. HDMI provides an interface between sources, such as set-top boxes, DVD players, and receivers and your projector. Plug an HDMI cable into the video-out connector on the video device and into the HDMI connector on the projector.

### Composite video connection

Plug the composite video cable's yellow connector into the video-out connector on the video device. Plug the other yellow connector into the yellow **Video** connector on the projector.

## VGA connection

If your video device has a 15-pin VGA output, plug one end of the included computer cable into the VGA connector on your video source. This connector may be labeled "To Monitor" on the video source. Plug the computer cable into either the **Computer 1** or **Computer 2** connector on the projector.

## Component video connection

If your HD video device has component connectors, an optional Component to VGA adapter can be used. Plug the component cable into the video device. Plug the other end of the component cable into the adapter and plug the adapter into the **Computer 1** or **Computer 2** connector.

## S-video connection

Plug the S-video cable's connector into the video-out connector on the video device. Plug the other connector into the **S-Video** connector on the projector.

## Audio

For PC audio jack, connect a 3.5mm stereo cable to the **Audio In** connector on the projector and to your source. If your source uses RCA audio connectors, a Y-cable or adapter may be used. For RCA audio jack, connect a RCA stereo cable to the **Audio/L** and **Audio/R** connectors on the projector and to your source. (Note: A separate audio connection is not required for HDMI source inputs.)

# Shutting down the projector

## Auto Off Time

The projector also has an Auto Off Time feature that automatically turns the projector off after no active sources are detected and no user interaction with the projector is performed for 30 minutes. By default, this feature is off. You can change the length of time, see page 29.

## Turning off the projector

To turn the projector off, press the **Power** button on the remote or keypad. The lamp turns off and the Power LED blinks orange for 1 minute while the fans continue to run to cool the lamp. If the Power Saving Mode feature is on and when the lamp has cooled, the LED lights orange and the fans stop. If the Power Saving Mode feature is off and when the lamp has cooled, the LED blinks orange and the fans stop. Unplug the power cable to completely power off the projector.



## Troubleshooting your setup

If your image appears correctly on the screen, skip to the next section. If it does not, troubleshoot the setup.

The Status Indicator Panel on top of the projector indicates the state of the projector and can help you troubleshoot.

**Table 3: Status indicator light behavior and meaning**

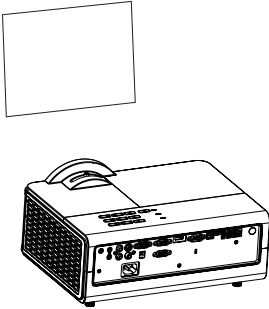
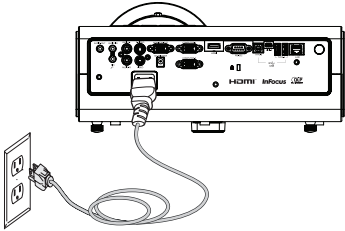
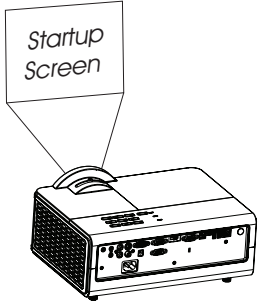
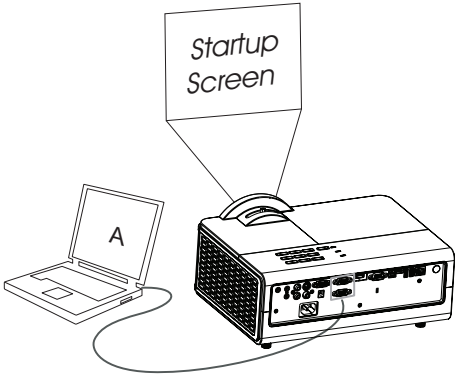
Status Indicator Light	Meaning
POWER: Solid orange	<ol style="list-style-type: none"><li>1. If the Power Saving Mode feature is on, the projector is plugged in.</li><li>2. The projector is on and initialized.</li><li>3. The projector is in normal operation.</li></ol>
POWER: Blinking orange	<ol style="list-style-type: none"><li>1. If the Power Saving Mode is off, the projector is plugged in.</li><li>2. The projector is powering down and the fans are cooling the projector.</li></ol>
POWER: Blinking orange TEMP: Blinking red LAMP: Blinking red	The projector fan(s) are not operating correctly and the projector has been shut down.
POWER: Solid orange TEMP: Blinking red LAMP: Blinking red	The lamp failed to ignite. Contact Technical Support if the problem persists. Visit <a href="http://www.infocus.com/support">www.infocus.com/support</a> to contact service.
POWER: Solid orange TEMP: Off LAMP: Blinking red	The lamp has reached its end of life and must be replaced. The lamp will continue to operate until it fails. Contact Technical Support. Repair may be needed.
POWER: Solid orange TEMP: Blinking red LAMP: Off	<ol style="list-style-type: none"><li>1. The projector is overheating and the lamp will be shut off. The fans will continue to run.</li><li>2. The projector will not turn back on until the cooling process is complete.</li></ol>

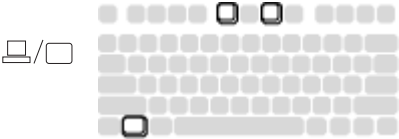
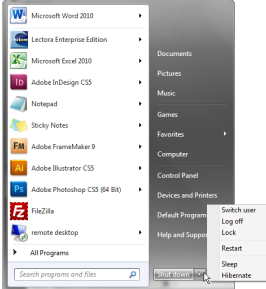
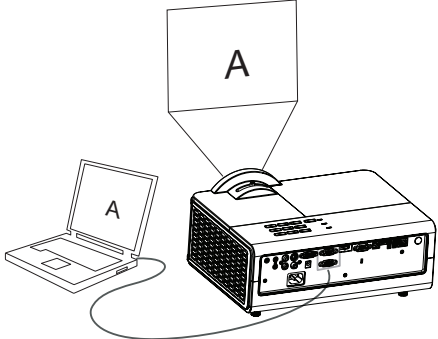
Problem	Solution	Result
<p data-bbox="48 115 244 142">No start up screen</p> 	<p data-bbox="661 115 1017 169">Plug power cord into the projector press power button</p> 	<p data-bbox="1183 115 1334 142">Correct image</p> 
<p data-bbox="48 502 340 529">Only start up screen appears</p> 	<p data-bbox="661 502 961 556">Press the Source button  activate laptop's external port</p>  <p data-bbox="678 816 835 842">Restart laptop</p> 	<p data-bbox="1183 502 1456 529">Computer image projected</p> 

### Problem

No computer image, just the words “Signal out of range”

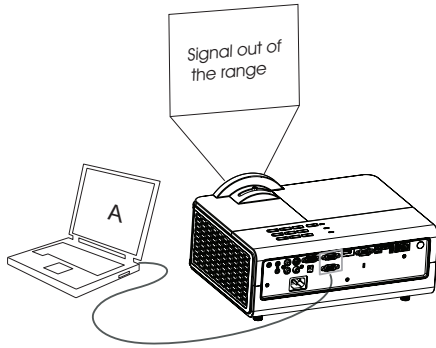

### Solution

Press the Auto Image button on remote  
Adjust computer refresh rate (Windows 7: Control Panel > Display > Screen Resolution > Advanced Settings > Adapter tab). Varies per operating system.

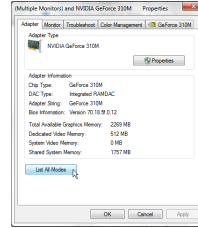

You may also need to set a different resolution on your computer, as shown in the following problem, “image fuzzy or cropped”

### Result

Computer image projected

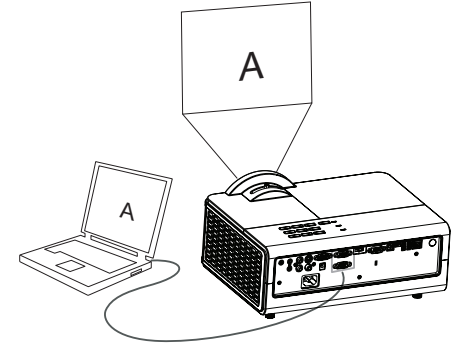

Only my laptop's background appears, not the Desktop icons

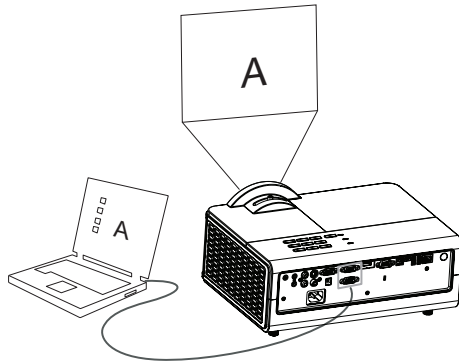

Change the Multiple Display setting to "Duplicate these displays" (Windows 7: Control Panel > Display > Screen Resolution). Varies per operating system.

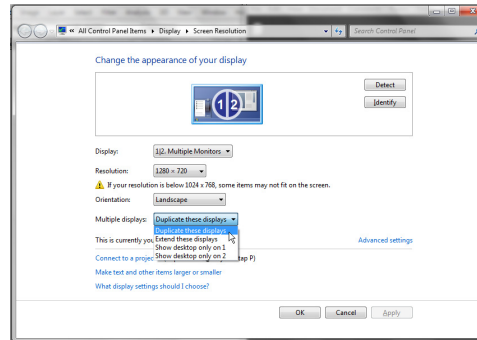

Background and Desktop projected

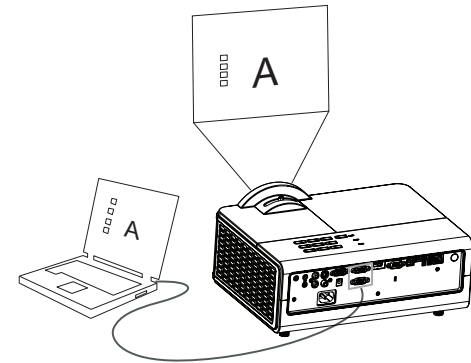

**Problem**

Image fuzzy or cropped

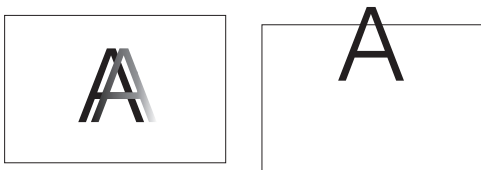
**Solution**

Change the computer's "Resolution" setting to match the projector's resolution (Windows 7: Control Panel > Display > Screen Resolution). Varies per operating system.

**Result**

Image clear and not cropped



Image not centered on screen

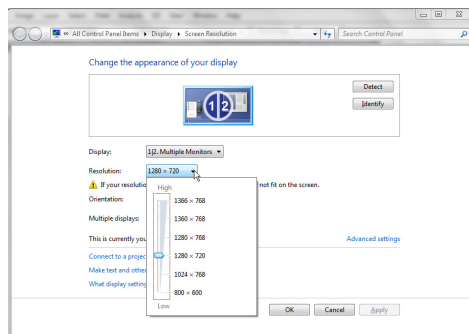
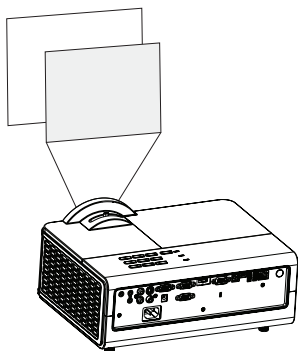

Move projector, adjust height

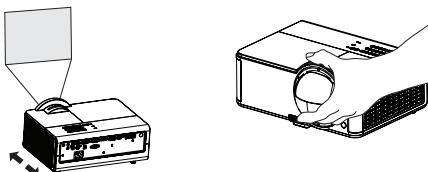



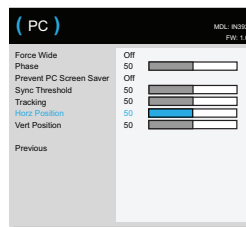

Adjust horizontal or vertical position in Advanced Menu > Image > PC menu

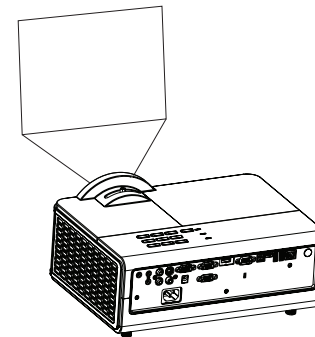

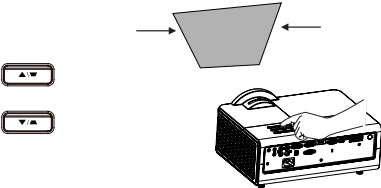
Correct image

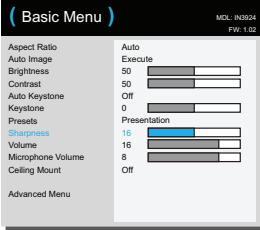

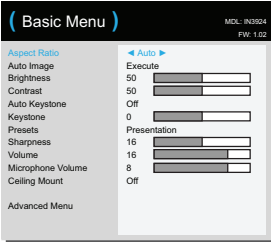
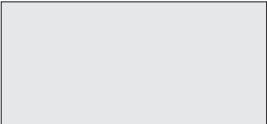
Problem	Solution	Result
<p data-bbox="48 96 222 119">Image not square</p> 	<p data-bbox="604 96 874 119">Adjust Keystone on keypad</p> 	<p data-bbox="1182 96 1315 119">Square image</p> 
<p data-bbox="48 357 210 379">Image not sharp</p> 	<p data-bbox="604 351 951 374">Adjust Sharpness in the Basic Menu</p> 	<p data-bbox="1182 362 1326 385">Correct image</p> 
<p data-bbox="48 655 413 678">Image does not fit 4:3 or 16:9 screen</p> 	<p data-bbox="604 655 1107 707">Change aspect ratio to 4:3 or 16:9 in Basic Menu &gt; Aspect Ratio menu</p> 	<p data-bbox="1182 649 1326 672">Correct image</p> 

**Problem**

Image upside down

**Solution**

Turn off Ceiling Mount in Basic menu

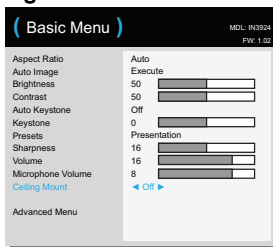
**Result**

Correct image



Image reversed left to right



Turn off Rear Project in Advanced Menu &gt; Setup &gt; Image Setup... menu

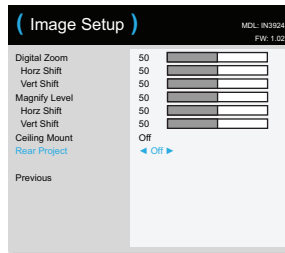

Correct image



Projected colors don't match source



Adjust the items in the Advanced Menu &gt; Image &gt; Color... menu

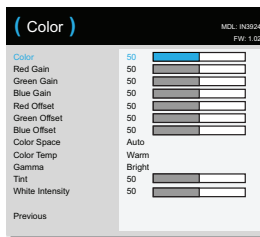

Correct image

COLOR

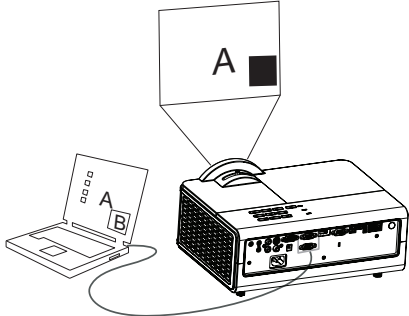
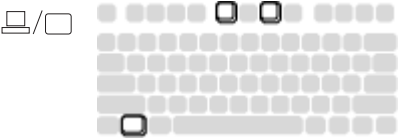
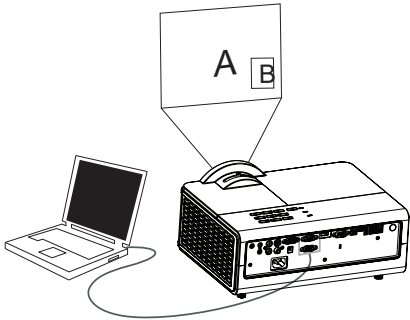
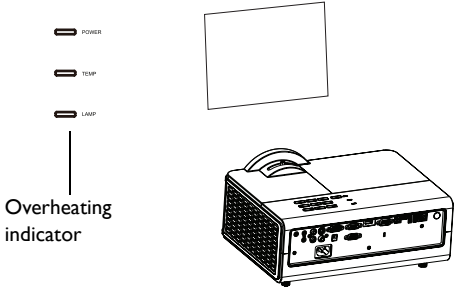
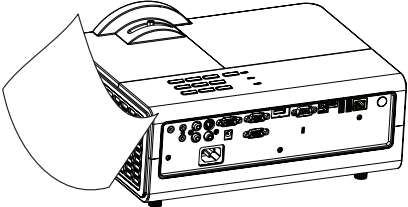
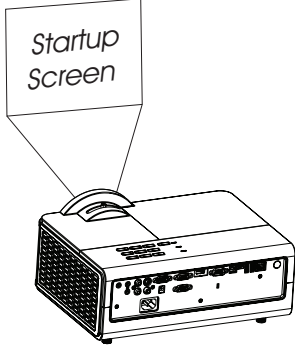
Problem	Solution	Result
<p data-bbox="48 101 574 153">The video embedded in my PowerPoint presentation does not play on the screen</p> 	<p data-bbox="604 101 1083 123">Turn off the internal LCD display on your laptop</p> 	<p data-bbox="1182 101 1499 123">Embedded video plays correctly</p> 
<p data-bbox="48 560 539 583">Lamp won't turn on, the projector is overheating</p>  <p data-bbox="93 904 204 950">Overheating indicator</p>	<p data-bbox="604 543 1135 594">Make sure vents aren't blocked, turn off the projector and allow it to cool for one minute</p> 	<p data-bbox="1182 548 1326 571">Lamp turns on</p> 

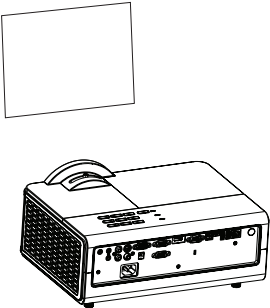
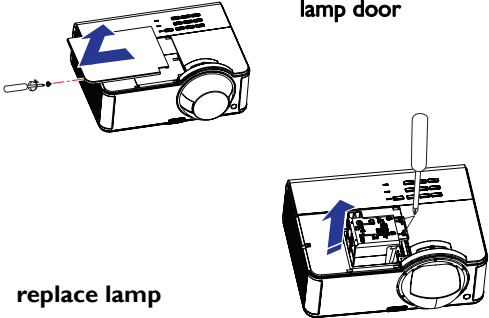
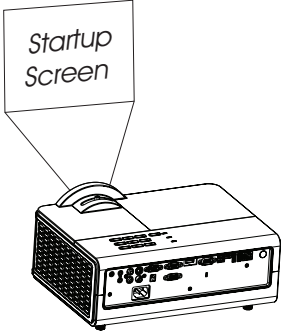
Problem	Solution	Result
<p data-bbox="48 89 531 141">“Replace lamp” message appears at startup, lamp won’t turn on</p> 	<p data-bbox="604 95 968 121">Lamp must be replaced (see page 46)</p>  <p data-bbox="951 144 1055 167">lamp door</p> <p data-bbox="666 429 812 452">replace lamp</p>	<p data-bbox="1182 87 1326 110">Lamp turns on</p>  <p data-bbox="1329 156 1420 222">Startup Screen</p>

**Still need assistance?**

If you need assistance, visit our website at [www.infocus.com/support](http://www.infocus.com/support) or call us. See the Warranty/Safety booklet for support contact information.

This product is backed by a limited warranty. An extended warranty plan may be purchased from your dealer. When sending the projector in for repair, we recommend shipping the unit in its original packing material, or having a professional packaging company pack the unit. Please insure your shipment for its full value.

# Using the remote control

The remote uses two (2) AAA batteries (not provided). They are easily installed by removing the cover from the remote's back, aligning the + and - ends of the batteries, sliding them into place, and then replacing the cover.

## Caution:

- When replacing the remote batteries, be aware that using batteries other than AAA batteries may risk severe damage to the remote. When disposing of the batteries, be sure to do so in an environmentally proper manner.
- If the remote control gets wet, wipe it dry immediately.
- Avoid excessive heat and humidity.
- Ensure the batteries' polarity (+/-) is aligned correctly.
- Do not mix new and old batteries together, or mix different types of batteries together.
- Replace the batteries as soon as they run out.
- Remove batteries from the remote control when storing or not in use for a prolonged period.

To operate, point the remote at the front of the projector (not at the computer). The range of optimum operation is about 15 feet (4.5m).

Press the remote's **Power** button to turn the projector on and off (see page 41 for shutdown info).

Press the remote's **Menu** button to open the projector's menu system. Use the arrow buttons to navigate, and the **Select** button to select features and adjust values in the menus. See page 25 for more info on the menus.

The remote also has:

- **Volume** buttons adjust the sound.
- **Custom** button that can be assigned to a special function, like Blank Screen or Freeze (see page 28).
- **Source** button brings up a menu of all possible sources allowing the user to switch the active source.
- **Blank** button to blank the screen.
- **Presets** button to select stored settings (see page 26).
- **Mute** button to silence the audio.

- **Auto Image** button to resynch the projector to the source.
- **Resize** button to switch among aspect ratios (see page 26).
- **Help** button to get help with connecting sources and improving the picture.
- **ESC** button to go back to previous OSD menu.
- **PC** button to cycle through the Computer sources.
- **Video** button to cycle through Composite/S-Video/HDMI input sources.
- **Keystone** buttons adjust the squareness of the image
- **Magnify** buttons magnify and reduce the projected picture size.
- **Freeze** button to pause the projected image.
- **Overscan** button remove noise around the video image.
- **AV Mute** button blanks the projected image and mutes audio.

## Troubleshooting the remote

- Make sure the batteries are installed in the proper orientation and are not dead.
- Make sure you're pointing the remote at the projector or the screen, not the computer, and are within the remote range of 15 feet (4.5m). For best results, point the remote at the projector.

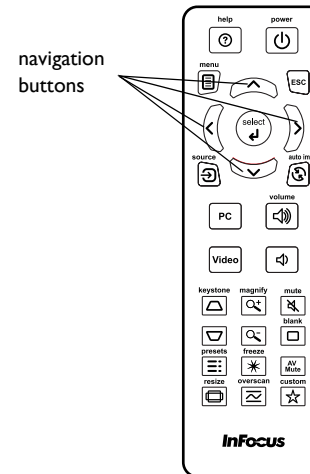

# Using the audio

## Using the projector's speakers

Connect the audio source to the Audio In or Audio L/R connectors to hear audio through the projector speakers. You may use the projector's speakers by connecting a microphone to the Microphone input connector.

Amplified speakers may also be connected to the projector using the Audio Out connector.

To adjust the volume, press the **Volume** buttons on the remote.

## Troubleshooting Audio

If you aren't hearing the audio, check the following:

- Make sure the audio cable is connected to the Audio In or Audio L/R connectors on the projector, and that the other end of the cable is connected to an Audio Out connector on the source (not a "line-in" or "microphone" connector).
- Make sure the volume is turned up enough. Press the **Volume** button on the remote.
- Make sure the correct source is active.
- Adjust the audio source.
- If playing a video, make sure the playback has not been paused.

connect PC audio cable

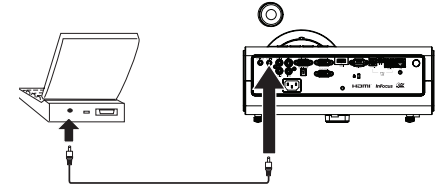

connect video source audio cable

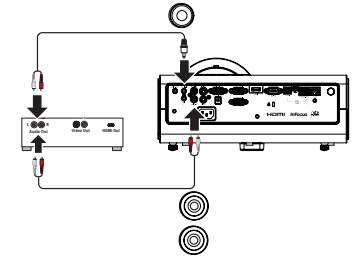

connect microphone

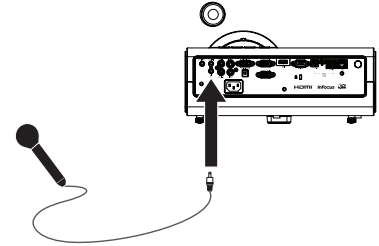

# Using the keypad buttons

Most buttons are described in detail in other sections, but here is an overview of their functions:

**Power**—turns the projector on and off (page 9).

**Auto**—resynchronize the projector to the source.

**Menu**—opens the onscreen menus (page 25).

**Enter**—selects items in the OSD menu and is used for USB storage device operation (page 39).

**Up/Down/Left/Right arrows**—When the menu is displayed, the up and down buttons navigate through the menu.

**Keystone**—adjusts the squareness of the image (page 10).

**Source**—brings up a menu of all possible sources allowing the user to switch the active source (page 9).

**Blank**—blanks the screen.

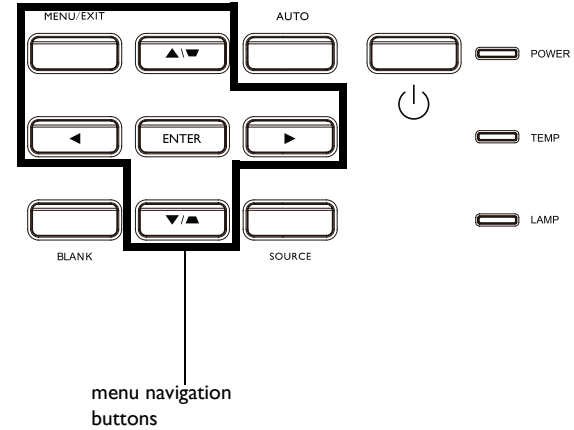

## Optimizing computer images

After the projector is running and the image is on the screen, you can optimize the image using the onscreen menus. For general information on using the menus, see page 25.

- Select default image settings using a preset appropriate to your environment.
- Adjust the Keystone, Contrast, or Brightness (page 26).
- Change the Aspect Ratio. Choose the option that best fits your input source (page 26).
- Adjust the Color Temperature (page 27).
- Adjust the Phase, Tracking, or Horizontal or Vertical position (page 27).
- Once you have optimized the image for a particular source, you can save the settings using Presets. This allows you to quickly recall these settings later (page 26).

## Presentation features

Several features are provided to make giving presentations easier. Here is an overview, details are found in the menu section.

- The Custom key allows you to assign various features to the button. The default effect is Source Info, which displays information about the projector and current source. See page 28 for details.
- The Search Screen option lets you change the appearance of the blank screen and start up screen (page 29).
- Auto Off Time is provided to automatically shut down the projector after several minutes. This helps preserve lamp life (page 29).

## Optimizing video images

After your video device is connected properly and the image is on the screen, you can optimize the image using the onscreen menus. For general information on using the menus, see page 25.

- Adjust the Keystone, Contrast, Brightness, Color, or Tint (page 26).
- Change the Aspect Ratio. Choose the option that best fits your input source (page 26).
- Select a Sharpness setting (page 26).
- Adjust the Color Temperature. Select a listed warmth value (page 27).
- Turn on Overscan to remove noise on the edges of the image (page 28).

## Customizing the projector

You can customize the projector for your specific setup and needs. See page 28 for details on these features.

- For rear projection, turn Rear Project on in the Advanced Menu > Setup > Image Setup menu.
- For ceiling mounted projection, turn Ceiling Mount on in the Basic menu.
- Specify which source the projector checks first for active video during power-up.
- Specify the function of the Custom key on the remote.
- Turn the projector's display messages on and off.
- Turn on power saving features.
- Specify appearance of blank screen and startup screen.
- Specify the language viewed on the menus.
- Save settings for the active source as a preset.

# Using the menus

- 1 To open the menus, press the **Menu** button on the keypad or remote. (The menus automatically close after 60 seconds if no buttons are pressed.) Use the arrow buttons to move up and down to review the menu options.
- 2 To enter a submenu, highlight the desired submenu and press > on the keypad or remote.
- 3 To adjust a menu setting, highlight the desired menu option and press < or > to scroll through the available adjustments.
- 4 Press the **Menu** button to exit the menu system.

The menus are grouped by usage:

- The Basic Menu provides common adjustments.
- The Advanced Menu provides more complex adjustments.

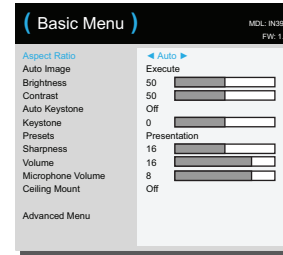
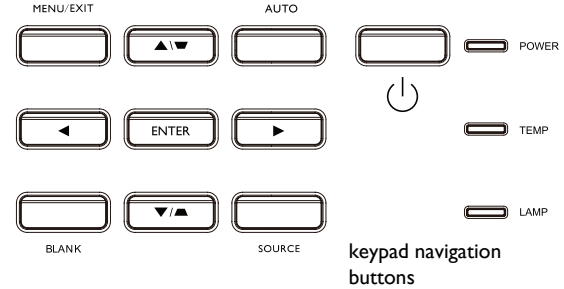

Basic Menu

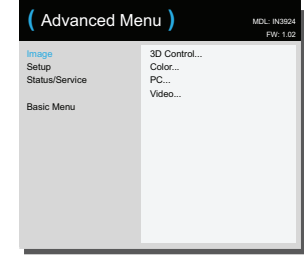

Advanced Menu

## Basic Menu

To adjust the following settings, highlight the setting, use the right and left arrows to adjust the values.

**Aspect Ratio:** Aspect ratio is the ratio of the image width to image height. TV screens are usually 4:3. HDTV and most DVDs are 16:9.

Select Auto to have the projector choose the ratio. Choose Native to see the unmodified input with no resizing by the projector. Select 16:9 to watch enhanced widescreen DVDs.

**Auto Image:** resets the projector to the source.

**Brightness:** changes the intensity of the image.

**Contrast:** controls the degree of difference between the lightest and darkest parts of the picture and changes the amount of black and white in the image.

**Auto Keystone:** enables and disables the projector's automatic vertical keystone adjustment.

**Keystone:** adjusts the image vertically and makes a squarer image. You can also adjust keystone from the keypad.

**Presets:** Presets are provided that optimize the projector for displaying computer presentations and video images under certain conditions. Note: Choosing User allows users to save their current settings as a User Preset. User Presets can be retrieved by pressing the Presets button on the remote and toggling to User.

**Sharpness:** Changes the clarity of the edges of a video image. Select a sharpness setting.

**Volume:** increases or decreases the audio volume.

**Microphone Volume:** adjusts the microphone sound level.

**Ceiling Mount:** turns the image upside down for ceiling-mounted projection.

## Basic Menu

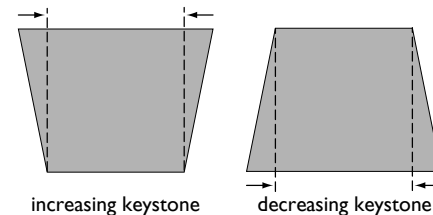
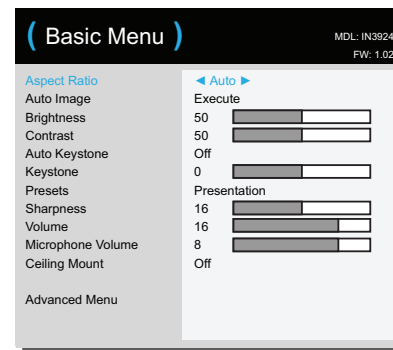

# Advanced Menu

Advanced Menu

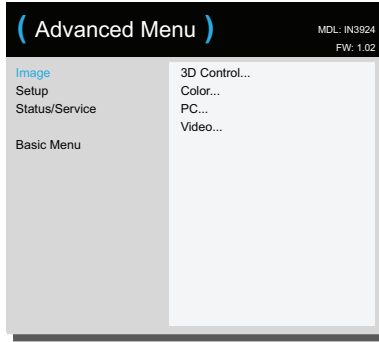

## Image:

### 3D Control:

**3D Control:** allows you to enjoy 3D (stereoscopic) content. Your projector supports two synchronization modes (External Sync and DLP Link™) for controlling LCD shutter glasses. In addition to the projector, you will need a pair of 3D shutter glasses, 3D content, and 3D compatible source (and emitter). Ensure the glasses you choose are consistent with the synchronization mode you will be using.

**3D Sync Invert:** (Only applies when 3D control is set to DLP Link™.) If the image appears to flutter, look odd or if the image depth looks off or you experience eye strain, turn this feature on to see if the image improves.

## Color

**Color:** adjusts a video image from black and white to fully saturated color. The color setting applies to video sources only.

**Red/Green/Blue Gain:** adjusts the gain of the red, green or blue channel of the image.

**Red/Green/Blue Offset:** adjusts the offset of the red, green or blue channel of the image.

**Color Space:** applies to computer and component video sources. It allows you to select a color space that has been specifically tuned for the input signal. When Auto is selected, the projector automatically determines the standard. To choose a different setting, turn off Auto, then choose RGB for computer sources or choose either REC709 or REC601 for component video sources.

**Color Temp:** changes the intensity of the colors. Select a listed relative warmth value.

**Gamma:** select the appropriate gamma from among Video, Film, Bright, and CRT.

**Tint:** adjusts the red-green color balance in the image of NTSC video images. The tint setting applies to NTSC video sources only.

**White Intensity:** increases the brightness of whites that are near 100%.

## PC:

**Force Wide:** when this is off, the analog locking algorithms choose the standard mode resolution (4:3) as the preferred default resolution. When this is on, the analog locking algorithms choose wide mode resolution (16:10) as the preferred default resolution.

**Phase:** adjusts the horizontal phase of a computer source.

**Prevent PC Screen Saver:** prevents your computer from going into Screen Save mode. The projector must be connected to the PC via a USB cable for this feature to work.

**Sync Threshold:** (progressive signals only) If a hardware device, such as a DVD player, is not syncing properly with the projector, select this option to help it to sync when connected to the projector.

**Tracking:** adjusts the vertical scan of a computer source.

**Horz/Vert Position:** adjusts the position of a computer source.

## Video:

**Detect Film:** determines whether the original source of the input video was film (progressive) or video (interlaced).

**Overscan:** removes noise around the video image.

**Set Black Level:** analyzes the current input image and calculates an offset value which is then added to the analog to digital converter black level value. This ensures optimum black level for each analog source.

## Setup:

### Audio Setup

**Internal Speakers:** turns the internal speakers on or off.

**Computer 1:** selects the audio input for Computer in 1 signal.

**Computer 2:** selects the audio input for Computer in 2 signal.

**Video:** selects the audio input for video source.

**HDMI:** select the audio input for HDMI signal.

### Closed Captions

**Closed Captions:** controls closed captioning. If the source is NTSC and contains captions on the selected channel, then the projector will display caption text overlaid on the image. When Closed Captions is off and volume is muted, closed captioning will appear. Options are: Off, CC1 and CC2.

### Image Setup

**Digital Zoom:** reduces the size of projector's display area. If the display area has been resized by this setting, it can be moved by changing the **Horz Shift** and **Vert Shift** settings.

**Magnify Level:** magnifies the image. If the image has been magnified by this setting, it can be moved by changing the **Horz Shift** and **Vert Shift** settings.

**Ceiling Mount:** turns the image upside down for ceiling-mounted projection.

**Rear Project:** reverses the image so you can project from behind a translucent screen.

## Keypad/Remote

**Blank Key:** select what to display when the blank key on the remote is pressed: a solid color screen (blue, black or white), or the factory logo screen.

**Custom Key:** allows you to assign a different function to the Custom button, allowing you to quickly and easily use the effect. Press < or > on the keypad or remote to choose a different one.

- **Blank Screen:** displays a solid color or factory logo screen..
- **Mute:** turns off all sound.
- **Source:** brings up a menu of available sources.
- **Auto Image:** resets the projector to the source.
- **Freeze Screen:** pauses the projected image.
- **Source Info:** the default action. Shows the Source Info menu.
- **Projector Info:** shows the Projector Info menu.
- **Overscan:** removes noise around the image.
- **AV Mute:** enables or disables AV Mute function.
- **Closed Captions:** enables or disables Closed Captions.

**Keypad:** enables or locks the projector keypad.

**LiteBoard™ Wand:** selects the LiteBoard™ Wand mode. Options are: None, Single Pen and Dual Pens.

## Lamp

**Programmed Dimming:** When enabled, Programmed Dimming enhances contrast ratios in dark scenes and disables Lamp Low Power. Programmed Dimming will impact lamp life and system noise performance. Programmed Dimming works in conjunction with the lamp. If Lamp Low Power is enabled, Programmed Dimming is unavailable.

**Lamp Low Power:** toggles between on and off. Turn it on to lower the light output of the lamp. This also lowers the fan speed, making the projector quieter.

## OSD Setup

**Language:** allows you to select a language for the onscreen display.

**Menu Position:** allows you to change the position of the On Screen Display items.

**Menu Transparency:** allows you to change how much of the projected image behind the menu you can see. As the value increases, more of the image behind the menu is visible.

**Show Messages:** displays status messages (such as “Searching”) in the lower-left corner of the screen.

## PIN Settings

**PIN Protect:** The PIN (personal identification number) feature allows you to password protect your projector. Once you enable the PIN feature, you must enter the PIN before you can project an image. Use the **Up/Down/Left/Right** arrows buttons on the remote or keypad to set a 4-button press sequence. If you enter an incorrect PIN 3 times in succession, the projector will automatically shut down. If you lose or forget your custom PIN, contact InFocus Technical Support.

### To enter the PIN at projector startup:

Power up the projector. The “**Enter PIN**” dialog box displays after the startup screen. Enter the PIN. Use the **Up/Down/Left/Right** arrows buttons on the remote or keypad to enter the correct 4-button press sequence. See the description above for instructions.

## To change the PIN:

Select “**Change PIN...**” in the Advanced Menu > Setup > PIN settings menu. Enter the existing PIN. Enter the new PIN.

## Power

**Power Saving Mode:** When the Power Saving Mode is On and the projector is in standby (powered off but connected to AC power), the monitor out function will not work.

## Source

**Auto Source:** When this feature is On, the projector automatically finds the active source, checking the selected Power-up Source first. When this feature is Off, the projector defaults to the source selected in Power-up Source. To display another source, you must manually select one by pressing the **Source** button on the remote or keypad and selecting one from the displayed Source menu.

**Power-up Source:** determines which source the projector checks first for active video during power-up.

**Search Screen:** allows you to display solid color screen (blue, black or white), or the factory logo screen at startup, and when no source is detected.

## Timer

**Auto Off Time:** automatically turns the projector off after no signals are detected for a preset number of minutes. If an active signal is received before the projector powers down, the image will be displayed.

## High Altitude

**High Altitude Setting:** We recommend you turn on the High Altitude Mode when your environment is between 5000' (1500m) and 10,000' (3000m) above sea level.

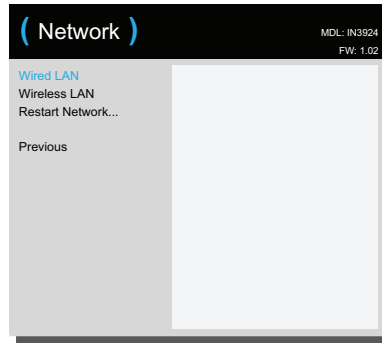

## Network

Allow you to configure the network settings.

### Wired LAN

**DHCP:** Abbreviation for Dynamic Host Configuration Protocol. This protocol automatically assigns IP Addresses to networked devices.

- When the “DHCP” is set to “On”, the DHCP server will assign an IP address to the projector automatically. This may take up to a minute.
- When the "DHCP" is set to "Off", the user will need to set the IP address manually.

**IP Address:** The numerical address used to identify devices on the network. This is only accessible when DHCP is set to Off.

- The IP Address is the number that identifies this projector on the network. You cannot have two devices with the same IP Address on the same network.
- The IP Address “0.0.0.0” is prohibited.

**Subnet Mask:** A numeric value defining the number of bits used in an IP Address when the network is divided into subnets. This function can only be used when DHCP is set to Off.

- The Subnet Mask “0.0.0.0” is prohibited.

**Default Gateway:** A server (or router) to communicate across networks (subnets) that are divided by a Subnet Mask. This function can only be used when DHCP is set to Off.

**DNS:** Setup DNS server address when DHCP is disabled.

**Mac Address:** Abbreviation for Media Access Control Address. A Mac Address is a unique ID number assigned to each network adapter.

**Apply:** Save and execute the wired network settings.

### Wireless LAN

**SSID:** Display the projector’s SSID information.

**IP Address:** a read-only display of IP Address.

**Subnet Mask:** a read-only display of Subnet Mask.

**Restart Network...:** Restart network settings.

### Status/Service:

**Source Info:** a read-only display of current source settings.

**Projector Info:** a read-only display of current projector settings.

**Reset Lamp Hours...:** resets the lamp hours used counter in the Projector Info menu to zero. Do this only after changing the lamp.

**Factory Reset...:** restores all settings to their factory default settings.

**Service Code...:** only used by authorized service personnel.

# Controlling the projector through a LAN environment

The projector supports Crestron<sup>®</sup> software. With correct settings for the **Network** menu, you can manage the projector from a computer using a web browser when the computer and the projector are properly connected to the same local area network.

## Wired connection

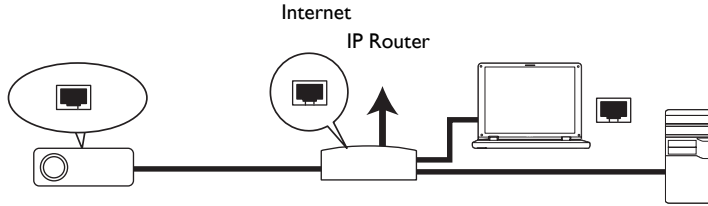

## Configuring the LAN control setting

### If you are in a DHCP environment:

- 1 Take a RJ45 cable and connect one end to the RJ45 LAN input jack of the projector and the other end to the RJ45 port .
- 2 Press **Menu** on the keypad or remote and then go to **Advanced Menu > Setup > Network** menu.
- 3 Press v to highlight **DHCP** and press < or > to select **On**.
- 4 Press v to highlight **Apply** and press >.
- 5 Please wait for around 15 - 20 seconds, and then re-enter the **Network** page. The **IP address, Subnet Mask, Default Gateway, DNS** and **Mac Address** settings will be displayed. Write down the IP address displayed in the **IP address** row.
  - If the Projector IP Address still does not display, contact your network administrator.

- If the RJ45 cables are not properly connected, the IP Address, Subnet Mask, Default Gateway, DNS and Mac Address settings will display 0.0.0.0. Make sure the cables are properly connected and perform the procedures above again.
- If you need to connect to the projector in its standby mode, set the **Power Saving Mode** feature to **Off**.

### If you are in a non-DHCP environment:

- 1 Repeat steps 1-2 above.
- 2 Press v to highlight **DHCP** and press < or > to select **Off**.
- 3 Contact your network administrator for information on the **IP address, Subnet Mask, Default Gateway, DNS** and **Mac Address** settings.
- 4 Press ^ or v to select the item you want to modify.
- 5 Press < or > to move the cursor and then press ^ or v to select the value.
- 6 Press v to highlight **Apply** and press > to save the settings.
  - If the RJ45 cables are not properly connected, the IP Address, Subnet Mask, Default Gateway, DNS and Mac Address settings will display 0.0.0.0. Make sure the cables are properly connected and perform the procedures above again.
  - If you wish to connect to the projector in its standby mode, be sure to select RJ45 and obtain the IP Address, Subnet Mask, Default Gateway, DNS and Mac Address information when the projector is on.

## Wireless connection

InFocus wireless dongle  
(p/n SP-WIFIUSB)

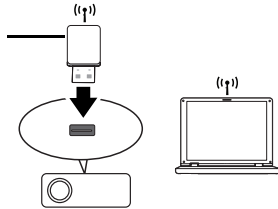

To connect to the projector wirelessly, you need to plug an optional InFocus wireless dongle (p/n SP-WIFIUSB) to the USB Type A connector on the projector, and then check the Wireless LAN Info on Network Info menu.

- 1 Make sure the projector is turned on.
- 2 Press **Menu** on the keypad or remote and then go to **Advanced Menu > Status/Service > Network Info**.
- 3 Make sure **SSID** and **IP Address** information are displayed.

## Controlling the projector remotely through a web browser

Once you have the correct IP address for the projector and the projector is on or in standby mode, you can use any computer that is on the same local area network to control the projector.

- If you are using Microsoft Internet Explorer, make sure it is version 7.0 or higher.
  - The screenshots in this manual are for reference only, and may differ depending on your browser.
- 1 Enter the address of the projector in the address bar of your browser and press **Enter**.

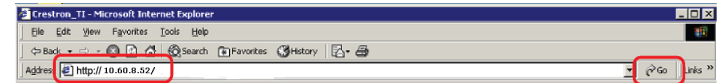

- 2 The main page of the Network Control displays.

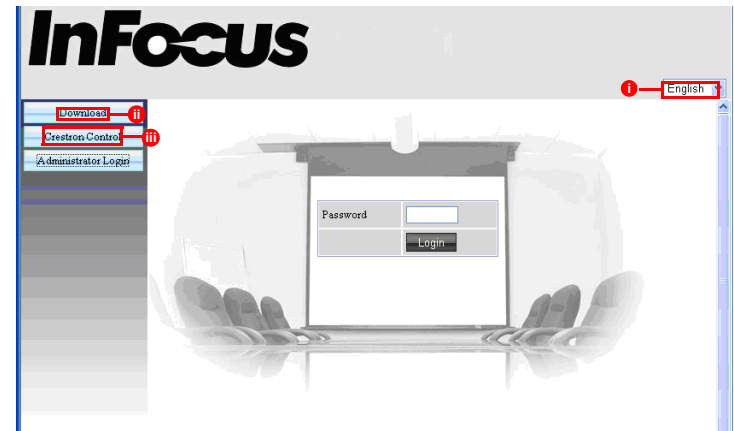

- i. To change the language for the web pages, click the down arrow to reveal a drop down list and select a desired language.
- ii. To download ifPresenter, click Download. See page 36 for details.

iii. The Crestron (eControl) page displays the Crestron eControl user interface. See page 33 for details.

3 To access the Admin page, enter the password. The default password is “admin”. If you forget the password, please go to Advanced Menu > Setup > Network > Restart Network to restore the password to the default code.

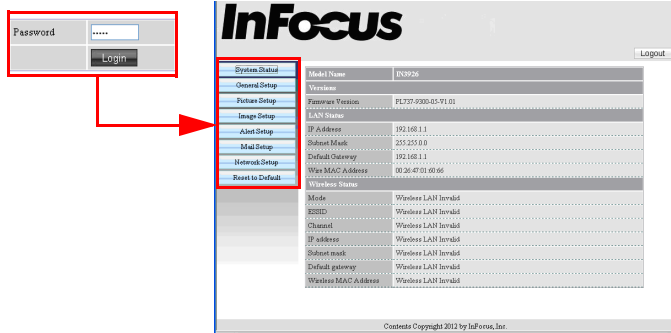

## About Crestron e-Control®

I The Crestron e-Control® page provides a variety of virtual keys to control the projector or adjust the projector’s image.



You can press </> to reveal more buttons.

- **System Status:** Displays the system information.
- **General Setup:** Allows you to turn on/off the projector, switch the input signal for the projector, and change the password for the Administrator page.
- **Picture Setup/Image Setup:** Provides some OSD menu items for adjusting the projected pictures. See page 25 for details.
- **Alert Setup/Mail Setup:** Allows you to setup the mail server and send system error messages to your network administrator.
- **Network Setup:** Provides wired and wireless network settings.
- **Reset to Default:** Allows you to restore the device to the factory default settings.

- These buttons function the same as the OSD menus and remote control functions.
- Source List:** To switch the source, click on the desired source.
- Menu:** Use to go back to the previous OSD menu, exit and save menu settings.
- When you use the projector control panel or remote control to change the OSD menu settings, it may take a while for the web browser to synchronize these changes with the projector.

- 2 The **Tools** page allows you to manage the projector, configure the LAN control settings and remotely access the network operations of this projector.

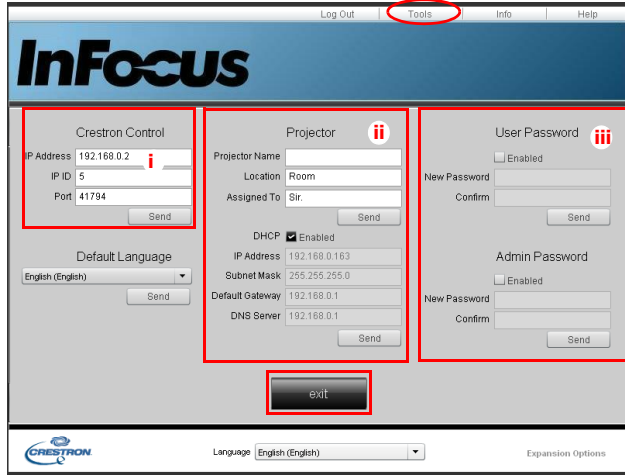

- i. This area is only used with a Crestron Control System. Please contact Crestron or refer to the Crestron user manual for setup information.
  - ii. This area is used for naming the projector, associating it with a particular location, assigning a responsible party to it, and adjusting network settings.
  - iii. This area is used to set User and Admin passwords. When password protection is enabled, unauthorized changes to the projector configuration will be avoided.
- To prevent errors, only enter alphanumeric characters on the **Tools** page.
  - After configuring the settings, press the **Send** button and the data will be saved in the projector.
  - Press **exit** to go back to the Crestron remote network operation page.

Please pay attention to the input length and character limitations (including character and punctuation restrictions) listed below:

	Input-Length	Maximum Number of Characters
Crestron Control	IP Address	15
	IP ID	2
	Port	5
Projector	Projector Name	10
	Location	9
	Assigned To	9
Network Configuration	DHCP (Enabled)	(N/A)
	IP Address	15
	Subnet Mask	15
	Default Gateway	15
	DNS Server	15
User Password	Enabled	(N/A)
	New Password	20
	Confirm	2
Admin Password	Enabled	(N/A)
	New Password	20
	Confirm	20

- / > < \$ % + \ ' " are prohibited.

3 The **Info** page displays the information and status of this projector.

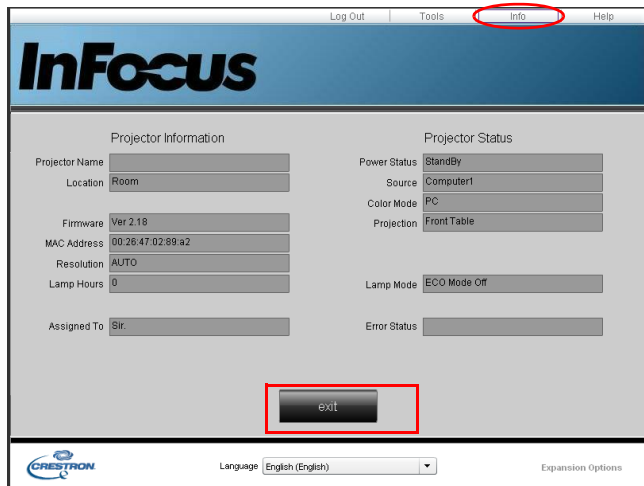

Press **exit** to go back to the Crestron remote network operation page.

4 After pressing the **Help** button, the **Title** window will display in the upper right corner of the screen. You will be able to send messages to RoomView™ software administrators/users who are connected to the same local area network.

- For more information, visit <http://www.crestron.com> and [www.crestron.com/getroomview](http://www.crestron.com/getroomview).

## Crestron RoomView

From the Crestron RoomView software in the **Edit Room** page, enter the IP Address (or hostname) as shown on the projector's on-screen display (OSD) menu, "05" for IPID, and "41794" for the reserved Crestron control port.

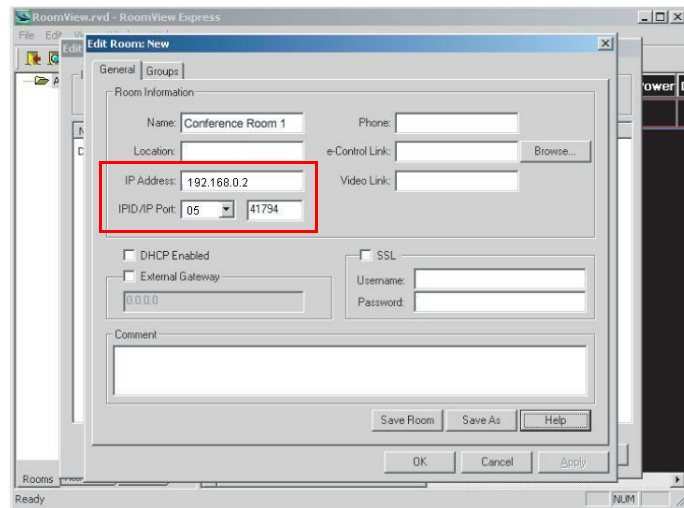

For the Crestron RoomView user guide and information about RoomView settings and commands, go to: [http://www.crestron.com/products/roomview\\_connected\\_embedded\\_projectors\\_devices/resources.asp](http://www.crestron.com/products/roomview_connected_embedded_projectors_devices/resources.asp)

# Displaying images through ifPresenter

## Downloading and installing ifPresenter

The ifPresenter is an application which can run on the host PC. It helps connect your computer to an available network projector and transfer the desktop content to the network projector via local network connection.

- 1 Enter the main page of Network Control. See steps 1-2 on page 32 for details.
- 2 Download ifPresenter.
- 3 When the download is complete, install the software to your computer by clicking the exe file. Follow the on-screen instructions to complete the installation.
- 4 Launch ifPresenter.

## Using ifPresenter

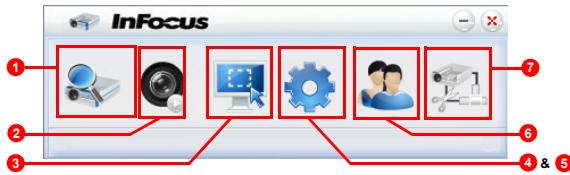

- 1 The Search page allows you to search and connect to a projector.

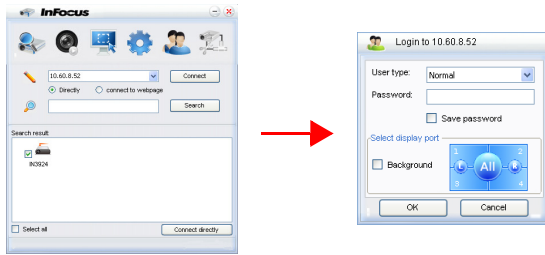

- i. To connect to a projector, select **Connect Directly** then type the projector's IP Address and click **Connect**.

- ii. To search for projectors, simply click **Search** to list all the projectors on the same local area network. Click the desired projector in the Search result list, and click **Connect directly**. You can also type a desired projector name and click **Search**.
- iii. You can link to the InFocus webpage control system on page 32.
  - If you are a first time user, choose your identity as a **Normal user** or **Administrator**. Neither requires a password. However if you choose to be an Administrator, you have the authority to set a password for connecting to the projector. That password should be written down and used to connect to the same projector.
  - If there are multiple computers connected to the projector, you can decide a display zone by clicking **I**, **2**, **3**, **4**, **L**, **R**, **All**, or **Background**.

- 2 If you want to freeze the projected image on the screen, press . Any further movements will be not been seen on the screen until is pressed.
- 3 You can choose a capture mode from here.

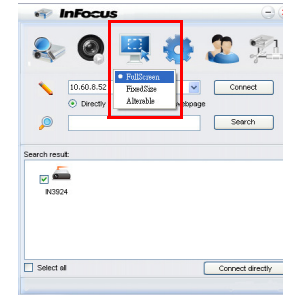

- i. To display a full screen, click **FullScreen**.
- ii. To display a partial screen, click **FixedSize**. A square appears on your screen. You can place it where you want to project.
- iii. If you wish to change the square, click **Alterable**.

#### 4 The Basic Setting page allows you to configure ifPresenter.

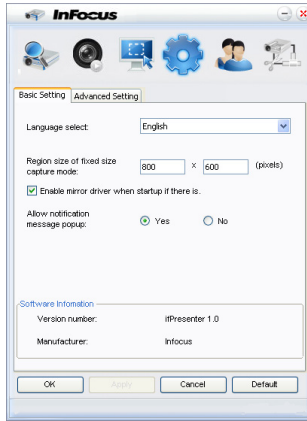

- i. To change the ifPresenter interface language, click the down arrow to reveal a drop-down list and select a desired language. Click **Apply**.
- ii. Users can change the size parameters of the frame in **FixedSize** capture mode by modifying width and height on this page and click **Apply** to make changes take effect.
- iii. User can use the mirror driver for presenter capture image, if the system has installed the mirror driver.
- iv. To allow notification messages to appear, click **Yes**. Click **Apply**.
- v. The Software Information is available on this page.

#### 5 The Advanced Setting page allows you to configure ifPresenter.

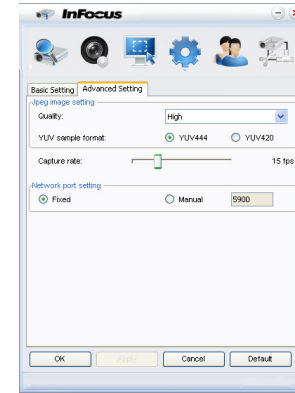

- i. To adjust the image quality, click the down arrow to reveal a drop-down list and select a desired quality level. The higher image quality you select, the higher network transfer speed is required. Select a YUV sample format between YUV444 and YUV420. Compared to format YUV420, format YUV 444 provides better image quality but may slow the loading and playing speed. Click **Apply** after your selections.
- ii. To adjust the capture rate, move the slide bar. The network bandwidth may also affect the performance.
- iii. Network port setting for fixed or manual type.

## 6 You can manage the connected projectors listed under Device Management.

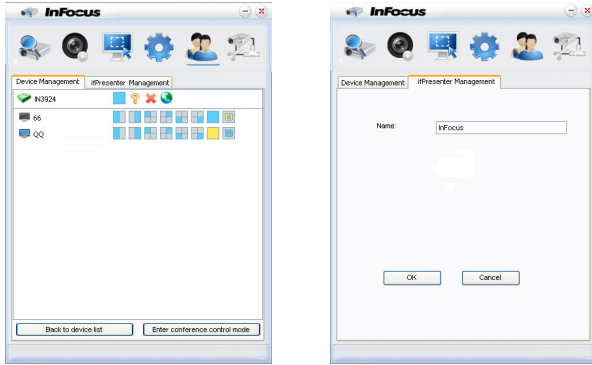

- Under a conference mode:
  - 1 Only the administrator can take control.
  - 2 A projector can display up to 4 computer screens.
- You can set the name of your computer under ifPresenter Management.

- For details about the icons, please see the following:

Icon	Description	Icon	Description
	You are a standard user and cannot change the password.		Disconnects from the projector.
	You are an administrator and can change the password.		Opens the web page of the Network Control.
	You are in control of the projector.		Someone else is controlling the projector.
	You are an administrator.		You are a standard user.
		Sets a display zone for the projector.	

## 7 Disconnect

To disconnect from the projector(s), click the **Disconnect** icon.

- Be sure to turn off other virtual network control programs before using ifPresenter.

# Displaying pictures with a USB storage device

The projector has a built-in application which can display images from a USB storage device. It can eliminate the need for a computer source.

## The projector supports the following image formats:

File format	Maximum pixel size
JPEG	8000 x 8000
GIF/TIFF/PNG/BMP	1280 x 800

- Progressive JPEG files are not supported.
- Some JPEG files may not display clearly.

## To display images from a USB storage device:

- 1 Plug the USB storage device into one of the USB Type A connectors.
- 2 Press the Source button and choose the USB A (Type-A) input. Note: If no other sources are connected and Auto Source is on, the projector will automatically select the USB A source.
- 3 Folders and supported files are displayed in thumbnail view.

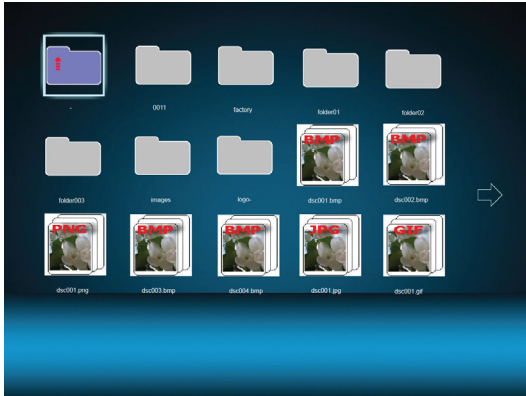

- To scroll through the thumbnails, use the arrow keys on your remote or the projector keypad.

- To open a file, highlight the file and press **Enter**. Press **Enter** again to close the file.
- To go back to the previous screen, select the thumbnail with an up arrow in the top left corner of the screen, and press **Enter**.
- To access additional USB display options, press the **Menu** button and then the **Enter** button. To close the USB Display menu, press the **Menu** button and then the **Enter** button again.
- To choose or cancel a menu option, use the left and right arrow buttons to highlight the option. Use the up and down arrow buttons to make a selection and press the **Enter** button.

## When viewing thumbnails



- **Next:** Selects the next folder/image.
- **Previous:** Selects the previous folder/image.
- **Thumbnail/Full Screen/SlideShow:** Displays the selected image(s) in Thumbnail, Full Screen or SlideShow mode.
- **NameOrder/ExtendOrder/SizeOrder/TimeOrder:** Sets the images to be displayed in the order of filenames, filename extension, file sizes, or time the photos were taken.
- **EXIF OFF/EXIF ON:** Toggles the EXIF data associated with the image on and off.
- **PathDisp OFF/PathDisp ON:** Toggles the display of the file name and path on and off.

## When viewing slide shows



- **Stop:** Stops the slide show.
- **Fast/Medium/Slow:** Sets the time interval each image displays. Fast displays an image every 3 seconds. Medium displays an image approximately every 10 seconds. Slow displays an image approximately every 15 seconds. Note: The actual display time varies based on the file size.

- **Slide Right/Slide Up/Right down/Random:** Sets the way the slide show is displayed.
- **Repeat On/Off:** Sets whether to repeat the slide shows.

### When viewing full screen images



- **Thumbnail/Full Screen/SlideShow:** Displays the selected image(s) in Thumbnail, Full Screen or SlideShow mode.
- **Best Fit/Actual Size:** Sets the display size of the image.
- **EXIFDisp OFF/EXIFDisp ON:** Toggles the EXIF data associated with the image on and off.
- **+ 90deg:** Rotates the image 90 degrees clockwise.
- **- 90deg:** Rotates the image 90 degrees counterclockwise.
- USB 2.0 compliant USB storage media (Mass Storage Class) is supported.
- We strongly recommend using an AC power adaptor with any USB hard drives.
- The following formats are recommended for any USB hard drives. FAT12/FAT16/FAT32 (NTFS format is not supported).
- Some USB flash drives may not work correctly with the projector.

- A security-enabled USB flash drive is not supported.
- Do not connect any apparatus other than USB storage devices. Do not charge other equipment through the USB connector. It may cause a malfunction.
- The projector plays up to 200 files in a folder.
- The filenames are displayed in the following order: symbols, digits, letters.
- The projector can display the filenames up to 16 characters including the file extension.
- The application displays English filenames the best. If the files are named in other languages, the filenames may not show properly, however the content will still display properly.
- Folders in the USB storage device can be recognized up to 3 layers. The priority of thumbnail display for image files is as follows:

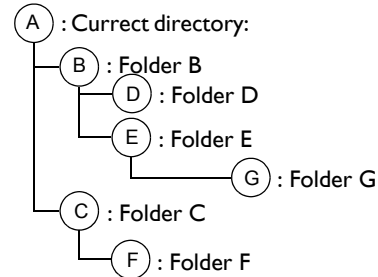

File display priority in folder: A > B > C > D > E > F.  
Folder G: Cannot be displayed

- Response times may vary depending on the image contents when switching pages, loading and playing files.

# LiteBoard™ Wand

The LiteBoard™ Wand works like a wireless mouse - but one that works in midair, not on your desktop. Just hold the wand in your hand, and point it at the projected image to point, click and drag. The wand works with all your software, just like a regular mouse.

## Charging the Wand's Battery

When the wand's amber battery light starts to blink, its internal battery is low (if the battery is fully discharged, you won't be able to turn the wand on by pressing its tip, left or right buttons).

To charge the battery, open the flap at the bottom of the wand to expose the wand's USB connector. Then connect a USB cable between the wand and the USB power adapter, or a computer (if connecting to a computer, make sure the computer is powered on). The battery light will stay on while the battery is charging, then it will turn off when the battery is fully charged.

When charging is finished, you can disconnect the USB cable (or keep the cable connected and use the wand while it's charging).

**NOTE:** 5-10 minutes of charging is enough for about an hour of wand use. A full charge will take 6-8 hours and will allow 20-40 hours of non-stop wand use. A fully charged, new wand will hold a charge in standby for up to 3 weeks.

**Caution:** The lithium battery is only rechargeable, and is not user serviceable or user replaceable.

**Caution:** Always use the included USB cable and power adapter (or your computer) to charge the wand.

## How to Use the Wand

- 1 The projector needs to be powered on and connected to your computer.
- 2 Connect the projector and your computer with a USB cable.
- 3 Connect the projector and your computer with a VGA cable.
- 4 Make sure the wand's battery is charged or charging.
- 5 Turn on the projector and make sure it's displaying the computer's screen -

set the source to Computer 1 or Computer 2 (press the source button on the projector or its remote if needed - you may need to press it several times).

- 6 Enable the LiteBoard™ Wand in the Advanced Menu > Setup > Keypad/Remote menu.
- 7 Turn on the wand by pressing its tip, left or right button - the wand's blue status light will start to blink.
- 8 Point the wand at the screen to point, click, and drag - just like a normal mouse. The Undo button is located at the bottom of the wand. You can select the function of the wand's Undo Button.

**NOTE:** When you're done, set the wand aside and make sure it isn't pointing at the screen; it will turn itself off automatically after 1 minute.

## Wand Position and Avoiding Shadows

### Your Location Distance from the Screen

You can use the LiteBoard™ Wand right up against the screen, or around the room. You might find that your pointing accuracy will improve if you get closer to the screen. Also, avoid standing too far off from either side of the screen.

### Avoid Shadows!

The wand won't work if its sensor is in a shadow or if it is pointing at a shadow:

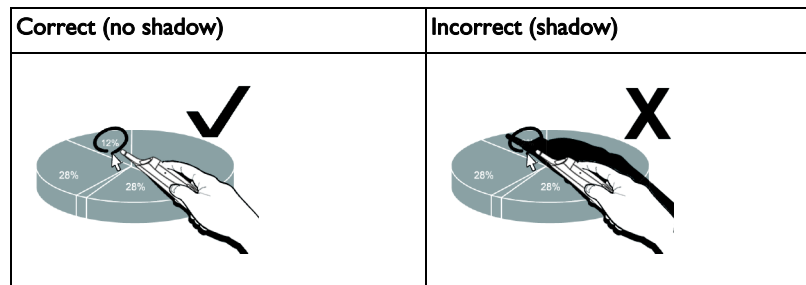

## How to Hold the Wand

You can hold the wand the way you would hold a normal pencil or pen, or you can hold it like a remote control - use in whichever position is most comfortable.

**NOTE:** If the wand is up close to the screen, you can press its tip against the projection surface to click and drag. Not recommended for use with fabric screens.

## Using More than One Wand

The projector can work with two wands at the same time.

- 1 Enter the Keypad/Remote menu under *Advanced Menu > Setup > Keypad/Remote* menu.
- 2 Scroll to the LiteBoard™ Wand function.
- 3 Select the desired setting:
  - None = No Liteboard Wand (Default)
  - Single = Use 1 Liteboard Wand
  - Dual = Use 2 Liteboard Wands

When you want to switch to a different wand:

- 1 Point the current wand away from the projected image for at least 3 seconds.
- 2 Press the tip, left or right button on the new wand to turn it on, and then start using the new wand.

**NOTE:** You can access the LiteBoard™ Wand menu from the projector's *Setup > Keypad/Remote* menu. Three options are available: None, Single Pen and Dual Pens.

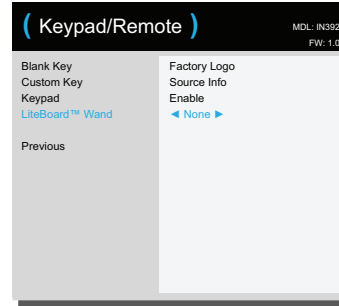

## Wand Features

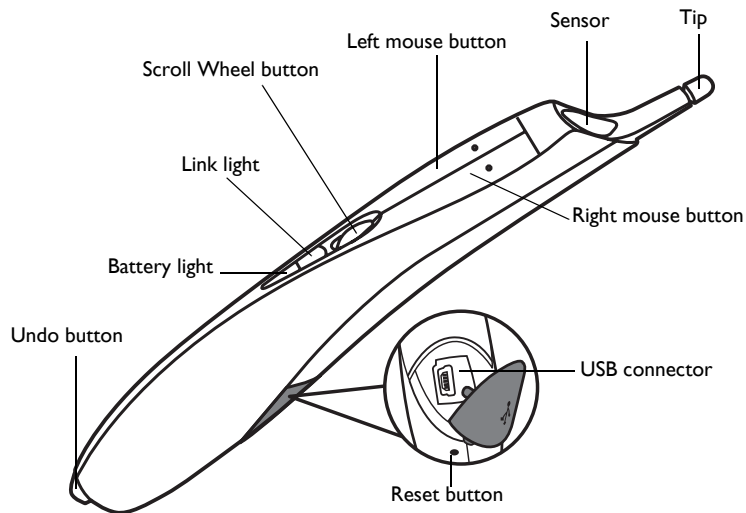

## Buttons and Wand Tip

The wand's three top buttons are equivalent to the left, right, and scroll wheel buttons on a mouse. The wand's tip is also a button, and is equivalent to the left mouse button.

**NOTE:** The Scroll Wheel button allows you to set the wand's motion mode. Toggle the Scroll Wheel button to select an active mode.

### Battery Light

The amber battery light shows the status of the wand's built-in battery (see below for battery information). The battery light will turn on while the wand is charging, and it will blink if the battery is low (2-4 hours of wand use left).

## Link Light

The blue link light shows the status of the wand's wireless connection to the projector. The link light will blink frequently (more than once per second) when the wand is attempting to link to the projector; then it will blink less frequently (about once every 4 seconds) after the wand has linked to the projector.

**NOTE:** The link light will stay off when the wand is off.

## USB Connector

The wand's USB connector is behind a flap on the back of the wand. The USB connector is only used for charging the wand's battery - using the included USB power adapter, or a computer.

**NOTE:** You can use the wand while charging the battery, but after the battery is charged (battery light turns off), you can unplug the USB cable and continue to use the wand without a cable.

## Undo Button

The wand's Undo button will function the same as the computer's Escape, Delete, or Backspace buttons, or the same as a Ctrl+Z (Windows/Linux) or Cmd+Z (Mac OS) command, depending on which function you select.

## Sensor

The wand's optical sensor opening is located above the wand's tip. Don't block the sensor, and make sure it always has a clear view of the screen.

**NOTE:** The sensor won't work if you point it at a shadow or away from the screen.

## Reset Button

The wand has a reset button, behind a small hole on its underside. Under normal conditions, you should not need to reset the wand. See the Troubleshooting section below for more information.

## Internal Radio

The wand has a built-in wireless transmitter/receiver which it uses to communicate with the projector.

## Lithium Battery Information

Manufacturer: HiTech Energy Inc.

Model: E3BE105K1002

Rating: 3.7V/800mAh

**Caution:** Lithium battery is only rechargeable, and not user replaceable. Not user serviceable.

## Troubleshooting LiteBoard™

For the most up-to-date information, visit our support site at [www.infocus.com/support](http://www.infocus.com/support)

- If the wand doesn't work at all, or it works intermittently, try one of these solutions:
  - **Press to Move** may be enabled; try holding down one of the wand's buttons while moving the wand.
  - Press the tip, left or right button on the wand to turn it on.
  - If the wand's blue Link light never blinks, then the wand's battery is fully discharged; connect the wand to the USB power adapter or your computer.
  - Make sure the wand is not pointing at a shadow and make sure its tip is not in a shadow.
  - If the room is brightly lit, reduce the room illumination.
  - If you're trying to use the computer's mouse at the same time as the wand, point the wand away from the screen while using the mouse.
  - If someone else is using a different wand with the same projector, they must stop using it before you can use another wand.
  - Reset the wand: push the end of a paper clip into the reset opening on the underside of the wand.
- If accurate clicking is difficult, try one of these solutions:
  - Hold the wand steadier when clicking.
  - Use the wand right up against the screen so it's easier to avoid unexpected movements.

- If the mouse pointer is in the wrong place on the screen, or the mouse pointer's movement is restricted to only part of the screen, try one of these solutions:
  - Make sure your projector is displaying the computer's screen and not some other source (such as DVD, VCR, etc.). To change the source, press the Source button on the projector or its remote.
  - Make sure the projector is displaying the same image as the computer's main or built-in monitor (don't extend your desktop onto multiple monitors). To correct this:
    - On Windows XP: Open the Display control panel, click Settings, click the display that represents the projector, then un-check "Extend my Windows desktop...".
    - On Windows Vista: Right-click on the desktop, choose Personalize..., click Display Settings, click the display that represents the projector, then un-check "Extend the desktop..."
    - On Windows 7.0: Right-click on the desktop, choose Screen Resolution, click the display that represents the projector, and then choose the "Duplicate Display..." under Multiple Displays.
    - On Macintosh: Select System Preferences from the Apple Menu, then select Displays. Click Arrangement, and check "Mirror Displays."
- If the battery light does not turn on when the wand is being charged, try one of the following:
  - Make sure a USB cable is connected between the wand and either the USB power adapter, or a USB port on your computer.
  - If the wand is connected to the USB power adapter, make sure the adapter is plugged in to a live electrical outlet. If the wand is connected to your computer, make sure the computer is powered on.
  - If the wand still won't charge, contact InFocus support at: [www.infocus.com/support](http://www.infocus.com/support).

# Maintenance

## Cleaning the lens

- 1 Apply a non-abrasive camera lens cleaner to a soft, dry cloth.
  - Projector must be off and the lens must be at room temperature.
  - Avoid using an excessive amount of cleaner, and don't apply the cleaner directly to the lens. Abrasive cleaners, solvents or other harsh chemicals might scratch the lens.
- 2 Lightly wipe the cleaning cloth over the lens in a circular motion.

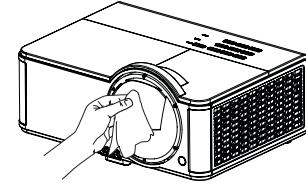

### WARNINGS:

- Turn the projector off and unplug power cord before cleaning any part of the projector.
- Do not touch or block the projector lens with any objects as this can damage the projector lens. Scratches, gouges and other lens damage are not covered by the product warranty.
- Do not open any cover on the projector, except the lamp cover.
- Do not attempt to service this product yourself as opening and removing covers may expose you to dangerous voltage and other hazards. Refer all servicing to qualified service personnel.

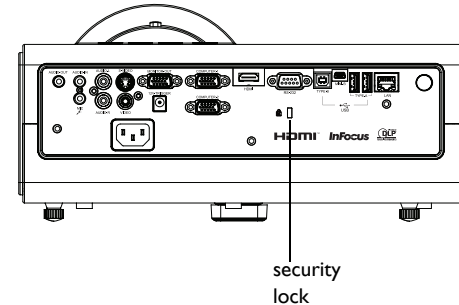

## Using the security lock

The projector has a security lock for use with a Cable Lock System. Refer to the information that came with the lock for instructions on how to use it.

## Replacing the projection lamp

The Lamp Hours timer in the Projector Info menu counts the number of hours the lamp has been in use. Twenty hours before the lamp life expires, the message “Replace lamp” displays on the screen at startup.

- **NOTE:** Be sure to use the InFocus lamp module designed for this projector. You can order new lamps from [www.infocus.com](http://www.infocus.com) (in select areas), your retailer or your dealer. **Only genuine InFocus lamps are tested for use in this projector.** Use of non InFocus lamps may cause electrical shock and fire, and may void the projector warranty. InFocus is not liable for the performance, safety or certification of any other lamps.

### WARNINGS:

- The projector uses a high-pressure mercury glass lamp. The lamp may fail prematurely, or it may rupture with a popping sound if jolted, scratched, or handled while hot. The risk of lamp failure or rupture also increases as the lamp age increases; please replace the lamp when you see the “Replace Lamp” message.
- To avoid burns, allow the projector to cool for at least 60 minutes before you replace the lamp.
- Do not touch or block the projector lens with any objects as this can damage the projector lens. Scratches, gouges and other lens damage are not covered by the product warranty.
- Unplug the power cord before replacing the lamp.
- Do not drop the lamp module. The glass may shatter and cause injury.
- Do not touch the glass surface of the lamp module. Fingerprints can obscure projection sharpness and may cause the glass to shatter.
- Be extremely careful when removing the lamp housing. In the unlikely event that the lamp ruptures, small glass fragments may be generated. The lamp module is designed to contain most of these fragments, but use caution when removing it.
- Before replacing a ruptured lamp, clean the lamp compartment and dispose of cleaning materials. Wash hands after lamp replacement.
- When replacing the lamp while the projector is ceiling-mounted, wear protective eyewear to prevent eye injury.

Hg – Lamp contains mercury. Manage in accordance with local disposal laws. See [www.lamprecycle.org](http://www.lamprecycle.org).

- 1 Turn off the projector and unplug the power cord.
- 2 Wait 60 minutes to allow the projector to cool thoroughly.
- 3 Remove the lamp door, located on top of the projector, by removing the screw on the side of the lamp door, sliding the door to the left, and lifting the lamp door off.
- 4 Loosen the captive screws that attach the lamp housing to the projector.  
**NOTE:** If the projector is installed on a ceiling mount, be careful not to drop the lamp module once the captive screws are loosened.
- 5 Carefully lift the lamp straight up, off of the alignment pins; being careful not to pinch the lamp connector. Dispose of the lamp in an environmentally proper manner.
- 6 Install the new lamp module, aligning the pins properly. Be careful not to pinch the lamp connector.
- 7 Tighten the screws. (**NOTE:** If the pins have not been aligned properly, the screws will not tighten securely.)
- 8 Replace the lamp door by reversing step 3 and locking it back into place.
- 9 Replace the lamp door screw and tighten securely.
- 10 Plug in the power cord and press the Power button to turn the projector back on.
- 11 To reset the lamp hour timer, navigate to the **Advanced Menu > Status/Service** menu and select **Reset Lamp Hours....**

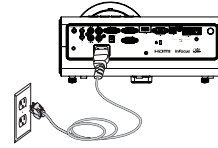

turn off and unplug projector

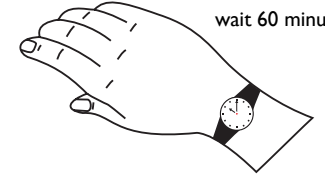

wait 60 minutes

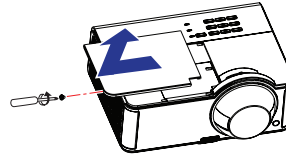

loosen lamp door screw

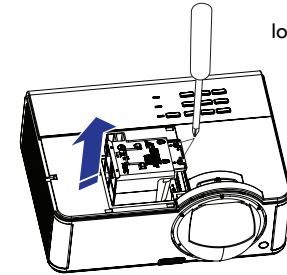

loosen screws

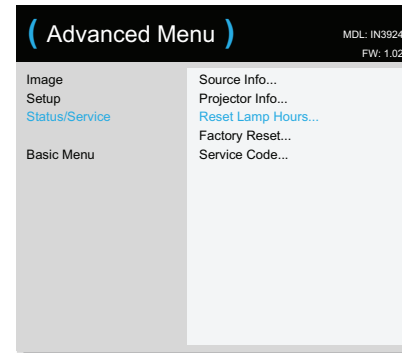

## INDEX

### Numerics

3D Sync Invert 27

### A

Apply 30

Aspect Ratio 26

Audio In Computer connector 8

Auto Image 26

Auto Keystone 26

Auto Off Time 29

Auto Source 29

AV Mute 28

### B

Battery Light 43

Blank Key 28

Blank Screen 28

Brightness 26

### C

Cable box 11

Ceiling Mount 28

Closed Captions 28

Color Space 27

Computer In connector 8

Connecting

Video device 11

Contrast 26

Crestron e-Control® 33

Crestron RoomView 35

### D

Default Gateway 30

Detect Film 28

DHCP 30

Digital Zoom 28

DNS 30

### F

Factory Reset 30

Focus 10

Force wide 27

Freeze Screen 28

### G

Gamma 27

### H

HDTV 26

High Altitude Setting 29

Horz Shift 28

Horz/Vert Position 27

### I

ifPresenter 32

Internal Radio 43

Internal Speaker 28

IP Address 30

### K

Keypad 28

Keypad buttons 22

Keystone 26

### L

Lamp Low Power 29

LAN 31

Link Light 43

LiteBoard™ Wand 41

### M

Mac Address 30

Magnify Level 28

Menu Transparency 29

Menu usage 25

Microphone Volume 26

Mute 28

### N

Network 30

**O**

Overscan 28

**P**

Phase 27

PIN Protect 29

Power connector 8

Power cord 8

Power Saving Mode 29

Prevent PC Screen Saver 27

Programmed Dimming 29

Projector

Keypad buttons 22

Menus 25

Positioning 7

Setting up 7

Troubleshooting problems 12

Projector Info 28, 30

**R**

Rear Project 28

Red/Green/Blue Gain 27

Red/Green/Blue Offset 27

Remote control 20

Reset Button 43

Resetting the projector 30

Restart Network... 30

**S**

Screen Aspect 11

Search Screen 29

Sensor 43

Service 30

Set Black Level... 28

Sharpness 26

Show Messages 29

Source 28

Source Info 28, 30

SSID 30

Subnet Mask 30

Sync Threshold 27

**T**

Tint 27

Tracking 27

Troubleshooting 12

Troubleshooting LiteBoard™ 44

**U**

Undo Button 43

USB 6

USB Connector 43

**V**

Vert Shift 28

Volume 26

Volume button 21

**W**

Warranty 19

Web browser 32

Wired LAN 30

Wireless connection 32

Wireless LAN 30