

# DIVIDED PICKUP GK-3

## Owner's Manual

Thank you for purchasing the **Roland GK-3** divided pickup. Before using this unit, carefully read the sections entitled:

- USING THE UNIT SAFELY (page 2-3)
- IMPORTANT NOTES (page 3)

These sections provide important information concerning the proper operation of the unit.

Additionally, in order to feel assured that you have gained a good grasp of every feature provided by your new unit, Owner's manual should be read in its entirety. The manual should be saved and kept on hand as a convenient reference.

---

**Copyright © 2003 Roland CORPORATION**

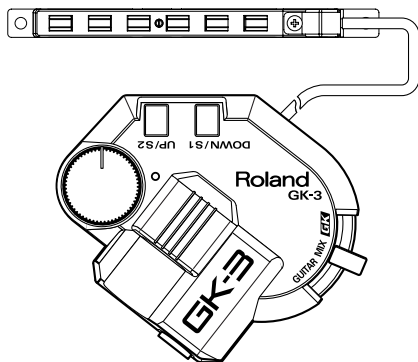

**All rights reserved. No part of this publication may be reproduced in any form without the written permission of Roland CORPORATION.**





# USING THE UNIT SAFELY

## INSTRUCTIONS FOR THE PREVENTION OF FIRE, ELECTRIC SHOCK, OR INJURY TO PERSONS

About ⚠ WARNING and ⚠ CAUTION Notices





 <b>WARNING</b>	Used for instructions intended to alert the user to the risk of death or severe injury should the unit be used improperly.
 <b>CAUTION</b>	Used for instructions intended to alert the user to the risk of injury or material damage should the unit be used improperly. * Material damage refers to damage or other adverse effects caused with respect to the home and all its furnishings, as well to domestic animals or pets.

About the Symbols





	The ⚠ symbol alerts the user to important instructions or warnings. The specific meaning of the symbol is determined by the design contained within the triangle. In the case of the symbol at left, it is used for general cautions, warnings, or alerts to danger.
	The ⊘ symbol alerts the user to items that must never be carried out (are forbidden). The specific thing that must not be done is indicated by the design contained within the circle. In the case of the symbol at left, it means that the unit must never be disassembled.
	The ● symbol alerts the user to things that must be carried out. The specific thing that must be done is indicated by the design contained within the circle. In the case of the symbol at left, it means that the power-cord plug must be unplugged from the outlet.

### ALWAYS OBSERVE THE FOLLOWING

#### **WARNING**

- Before using this unit, make sure to read the instructions below, and the Owner's Manual. 
- Do not open or perform any internal modifications on the unit. 
- Do not attempt to repair the unit, or replace parts within it (except when this manual provides specific instructions directing you to do so). Refer all servicing to your retailer, the nearest Roland Service Center, or an authorized Roland distributor, as listed on the "Information" page. 
- Never use or store the unit in places that are:
  - Subject to temperature extremes (e.g., direct sunlight in an enclosed vehicle, near a heating duct, on top of heat-generating equipment); or are
  - Damp (e.g., baths, washrooms, on wet floors); or are
  - Humid; or are
  - Exposed to rain; or are
  - Dusty; or are
  - Subject to high levels of vibration.   



#### **WARNING**

- Do not allow any objects (e.g., flammable material, coins, pins); or liquids of any kind (water, soft drinks, etc.) to penetrate the unit.   

- Immediately turn the power off, and request servicing by your retailer, the nearest Roland Service Center, or an authorized Roland distributor, as listed on the "Information" page when:
  - If smoke or unusual odor occurs
  - Objects have fallen into, or liquid has been spilled onto the unit; or
  - The unit has been exposed to rain (or otherwise has become wet); or
  - The unit does not appear to operate normally or exhibits a marked change in performance. 
- In households with small children, an adult should provide supervision until the child is capable of following all the rules essential for the safe operation of the unit. 
- Protect the unit from strong impact. (Do not drop it!) 

## CAUTION

- Try to prevent cords and cables from becoming entangled. Also, all cords and cables should be placed so they are out of the reach of children. 

---

- Never climb on top of, nor place heavy objects on the unit. 

---

- Disconnect all cords coming from external devices before moving the unit. 

---

- Should you remove the parts of installation, make sure to put them in a safe place out of children's reach, so there is no chance of them being swallowed accidentally. 

## IMPORTANT NOTES

In addition to the items listed under "USING THE UNIT SAFELY," please read and observe the following:

### Power Supply

- Before connecting this unit to other devices, turn off the power to all units. This will help prevent malfunctions and/or damage to speakers or other devices.

### Placement

- Using the unit near power amplifiers (or other equipment containing large power transformers) may induce hum. To alleviate the problem, change the orientation of this unit; or move it farther away from the source of interference.
- Noise may be produced if wireless communications devices, such as cell phones, are operated in the vicinity of this unit. Such noise could occur when receiving or initiating a call, or while conversing. Should you experience such problems, you should relocate such wireless devices so they are at a greater distance from this unit, or switch them off.
- Do not expose the unit to direct sunlight, place it near devices that radiate heat, leave it inside an enclosed vehicle, or otherwise subject it to temperature extremes. Excessive heat can deform or discolor the unit.

- When moved from one location to another where the temperature and/or humidity is very different, water droplets (condensation) may form inside the unit. Damage or malfunction may result if you attempt to use the unit in this condition. Therefore, before using the unit, you must allow it to stand for several hours, until the condensation has completely evaporated.

### Maintenance

- For everyday cleaning wipe the unit with a soft, dry cloth or one that has been slightly dampened with water. To remove stubborn dirt, use a cloth impregnated with a mild, non-abrasive detergent. Afterwards, be sure to wipe the unit thoroughly with a soft, dry cloth.
- Never use benzene, thinners, alcohol or solvents of any kind, to avoid the possibility of discoloration and/or deformation.

### Additional Precautions

- Use a reasonable amount of care when using the unit's buttons, sliders, or other controls; and when using its jacks and connectors. Rough handling can lead to malfunctions.
- When connecting / disconnecting all cables, grasp the connector itself—never pull on the cable. This way you will avoid causing shorts, or damage to the cable's internal elements.
- To avoid disturbing your neighbors, try to keep the unit's volume at reasonable levels. You may prefer to use headphones, so you do not need to be concerned about those around you (especially when it is late at night).
- When you need to transport the unit, package it in the box (including padding) that it came in, if possible. Otherwise, you will need to use equivalent packaging materials.
- Use a cable from Roland to make the connection. If using some other make of connection cable, please note the following precautions.
  - Some connection cables contain resistors. Do not use cables that incorporate resistors for connecting to this unit. The use of such cables can cause the sound level to be extremely low, or impossible to hear. For information on cable specifications, contact the manufacturer of the cable.

## **USING THE UNIT SAFELY .. 2**

## **IMPORTANT NOTES ..... 3**

## **Panel Descriptions ..... 5**

## **Attaching the GK-3 to the Guitar..... 6**

### **Precautions Before Installing ....6**

### **Adjusting the Divided Pickup ....8**

### **Attaching the Divided Pickup ....8**

Attaching the  
Pickup with Double-Sided Tape.....9

Attaching the  
Pickup with Screws .....12

Attaching the  
Pickup with the Pickup Holder ....13

### **Checking and Finely**

### **Adjusting the Pickup Height ....14**

### **Attaching the Controller .....15**

Adjusting the  
Length of the Pickup Cable .....15

Attaching with the Holder .....16

Attaching with  
Double-sided Tape and a Screw ...17

## **How to Connect the GK-3 ..... 18**

## **Specifications ..... 20**

The GK-3 is a special divided pickup, which, when installed on an ordinary guitar, allows you to use the guitar to play the sounds of GK-compatible guitar devices (Roland GR-20 or VG-99 etc.).

- The pickup's adjustable curve mechanism makes the GK-3 compatible with guitars with different fingerboard (string) curves.
- Included with the GK-3 are special holders, spacers, and other accessories, which allow you to easily attach the unit to any of a wide variety of guitar models.
- You can use the controller switches to control the various functions of connected GK devices.

## **About the GK-3 Warranty**

Roland guarantees the GK-3 (and all included parts) to be free of defects in materials and workmanship. Contact your retailer or nearest Roland Service Center if repairs become necessary.

Roland cannot be responsible for any damage caused to your guitar or the GK-3 as a result of your attempt to install or remove the GK-3. If you are not confident with your ability to properly install the Pickup or Controller unit (especially where drilling is involved), please contact your Roland retailer or nearest Roland Service Center.

\* All product names mentioned in this document are trademarks or registered trademarks of their respective owners.

# Panel Descriptions

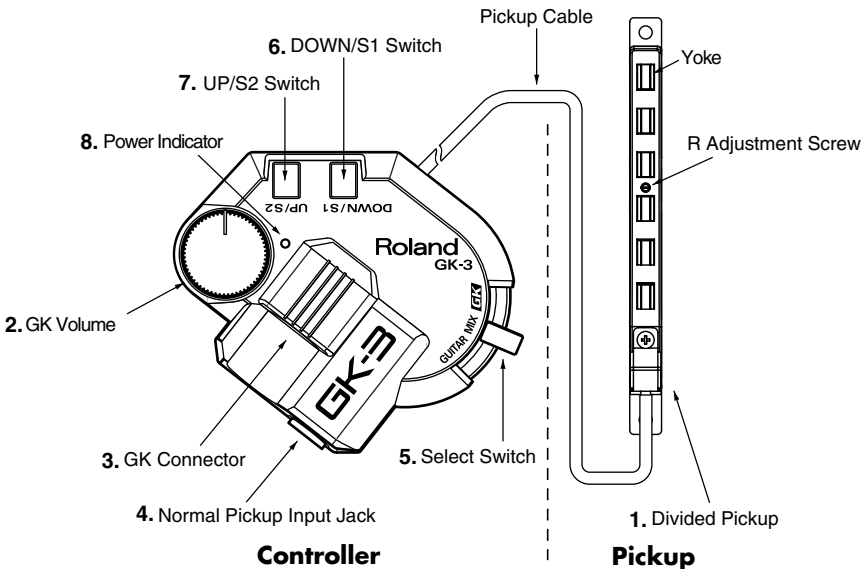

## 1. Divided Pickup

This pickup detects the vibrations of the guitar strings. It is attached between the guitar bridge and the bridge pickup.

## 2. GK Volume

This controls the volume of the connected GK-compatible device.

\* Certain GK-compatible devices also permit the GK Volume function to be changed. For more detailed information, refer to the Owner's Manual for the GK-compatible device being connected.

## 3. GK Connector

Connect the GK-compatible device to this connector.

## 4. Normal Pickup Input Jack

This jack is for inputting the guitar's normal pickup signals to the GK-3. Connect using the normal guitar cable included with the GK-3.

## 5. Select Switch

This switches between the output from the connected GK-compatible device and the normal guitar output.

\* Changing the GK Volume function also changes the function of this switch. For more detailed information, refer to the Owner's Manual for the GK-compatible device being connected.

## 6. DOWN/S1 Switch 7. UP/S2 Switch

The function of the S1 and S2 switches varies according to the GK-compatible device connected. For more detailed information, refer to the Owner's Manual for the GK-compatible device being connected.

## 8. Power Indicator

This indicates that power is being supplied to the GK-3. Power to the GK-3 is supplied by the connected GK-compatible device via the GK cable. No battery or other power source is required.

# Attaching the GK-3 to the Guitar

The GK-3 can be attached to and used with conventional electric and acoustic guitars. Please read the following precautions before installing the GK-3.

## Precautions Before Installing

---

- If double-sided tape is used to attach the divided pickup to your guitar for an extended period of time, you may experience one or more of the following (or other) issues when the tape is removed:
  - Adhesive residue or other marks remain on the guitar
  - A portion of the guitar's finish comes off, or is discoloredPlease be aware of these risks and exercise due caution when using double-sided tape.
- Do not use the GK-3 with 12-string guitars or guitars with other unusual or customized string setups, guitars strung with non-metal core nylon strings. The unit will not function properly with these instruments.
- Make any adjustments to the guitar neck, string height, and other such modifications before installing the GK-3.
- Try placing the divided pickup and the controller unit on the guitar before actually attaching them to confirm that there will be no problem with the installation.
- When using the screw to attach the controller, we recommend that you first attach the GK-3 temporarily using the holder, then after confirming that there are no problems when actually performing with the unit, secure it with the screw.
- If only the double-sided tape is used to attach the controller, shocks from rough handling during performances and from extended use will cause the tape to deteriorate, with the controller shifting out of position as a result. Also, if the finish on your guitar is less than perfect, you may discover that the finish is also removed when you later remove the tape. The supplied tape is intended to be used only very temporarily, to help you determine the optimum position for the controller.
- With certain guitars, the space between the pickup at the bridge position and the bridge itself is too narrow to allow installation of the divided pickup. In such instances, it may be possible to attach the pickup by modifying the guitar (for example, by moving the bridge pickup more towards the neck to make room for the divided pickup); consult your guitar dealer.

Confirm that the package contains all of the following parts for installing the GK-3.

**Flat-head Screw 3x16 mm**

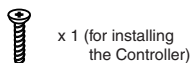

**Wood Screw 3x20 mm**

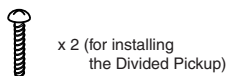

**Spring**

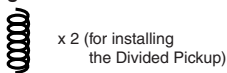

**Double-sided tape A**

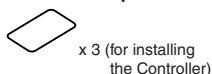

**Double-sided tape B**

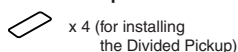

**Double-sided tape C**

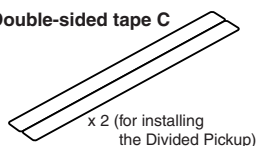

**Holder A**

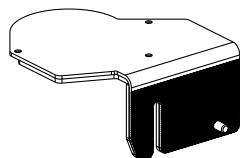

**Normal Guitar Cable**



**Pickup Cushion**

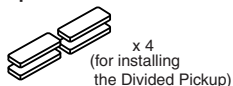

**Pickup Spacer A**

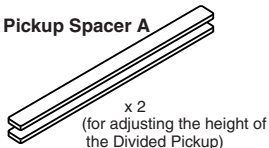

**Pickup Spacer B**

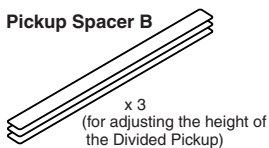

**Pickup Spacer C**

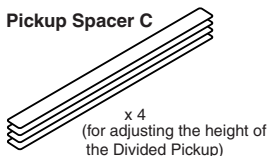

**Holder B**

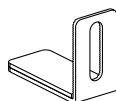

**Clearance Gauge**



**Cushion**

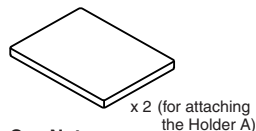

**Cap Nut**

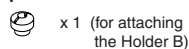

**Spring Washer**

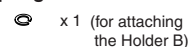

**Flat Washer Ø15 mm**

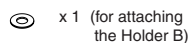

**Pickup Holder**

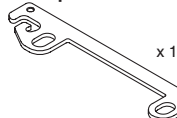

**Rubber Sheet**

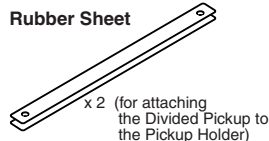

**Rubber Tube**

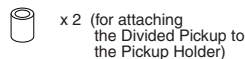

**Screw 3x8 mm**

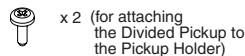

**Flat Washer Ø13 mm**

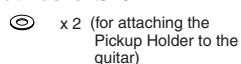

**Screwdriver**



---

## Adjusting the Divided Pickup

---

The surface of a guitar's fingerboard is not flat, but describes a large arc from the first string to the sixth string, and the strings themselves are laid out in roughly the same curved arrangement. The divided pickup uses independent coils to pick up the vibrations of each separate string, so variations in the clearance between the strings and their corresponding pickups may result in discrepancies in sensitivity for each string. The GK-3's divided pickup features a mechanism that allows you to adjust the curve outlined by the pickups, making the GK-3 compatible with different types of guitars.

### 1. Check the curve of the fingerboard on the guitar to which the GK-3 is to be attached.

- \* Refer to the guitar manual or catalog, or consult the guitar manufacturer.
- \* If you are not sure of your guitar's curve, attach the pickup to the guitar with the yokes left in the lowered position, then adjust the yokes after the pickup has been installed.

### 2. Adjust the pickups with the supplied screwdriver.

When completely extended (i.e., with the adjustment screw turned fully clockwise), the yoke is set to approximately 184R; when the yoke is in the fully lowered position, the setting is approximately 400R. If the guitar has a fingerboard curve with a value such as 250R or 300R, first adjust the yoke so that the yoke height is approximately midway between the fully

extended and lowered positions, then adjust to the optimal positions after the pickup is installed.

- \* Be sure not to turn the adjustment screw too much. When raising the yoke, rotate the adjustment screw slowly clockwise, and stop turning the screw at the point where you feel further resistance. Continuing to turn the screw beyond this point may result in damage to the unit.

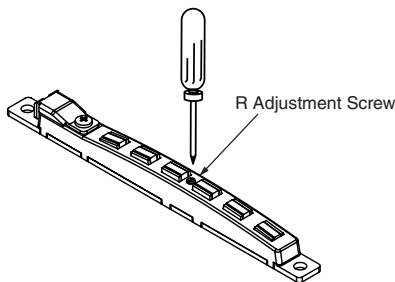

---

## Attaching the Divided Pickup

---

There are three ways to attach the divided pickup.

### ● Attaching the Pickup with Double-Sided Tape (p. 9)

This provides the simplest way to attach the pickup to flat-top guitars.

### ● Attaching the Pickup with Screws (p. 12)

This method features the benefit of allowing the pickups to be finely adjusted later on, but it is somewhat difficult to carry out.

- \* Do not place any unnecessary strain on the cable connecting the pickup and the controller. This may result in breaking.
- \* Do not bend or twist the pickup. Use particular care when removing the pickup.

### ● Attaching the Pickup with the Pickup Holder (p. 13)

This is the simplest method for guitars with the bridge mounted on posts embedded in the guitar body.

## ■ Attaching the Pickup with Double-Sided Tape

- \* If double-sided tape is used to attach the divided pickup to your guitar for an extended period of time, you may experience one or more of the following (or other) issues when the tape is removed:

- Adhesive residue or other marks remain on the guitar
- A portion of the guitar's finish comes off, or is discolored

Please be aware of these risks and exercise due caution when using double-sided tape.

### 1. Place the pickup between the guitar's body and strings, and determine the position for attachment.

In principle, the pickup should be centered with respect to the six strings, as close to the bridge as possible.

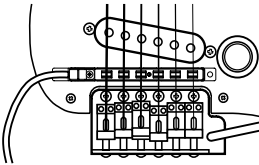

- \* If your guitar has a tremolo unit (whammy bar), then attaching the pickup at the bridge position may bring the pickup into direct contact with the tremolo unit. Position the pickup so that it will not interfere with operation of the tremolo unit.
- \* Attach the pickup about 15 mm (9/16") from the bridge if your guitar is strung with copper, brass, or bronze wound strings, such as with an acoustic guitar.
- \* Regardless of the guitar, do not position the divided pickup more than 20 mm (13/16") from the bridge.

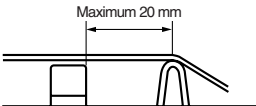

- \* When viewed from the front, the strings do not necessarily need to be aligned perfectly with the center of the yokes. Each string need only pass over some portion of its yoke.

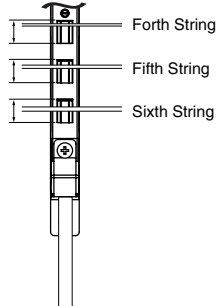

- \* Be sure the divided pickup is correctly oriented. The cord from the pickup should emerge from under the sixth string.

When you have determined the position in which the pickup is to be attached, mark the position with a pencil, cellophane tape or other appropriate marking.

### 2. Be sure the neck curvature and string height are set properly, then tune each string to its normal tuning.

- \* Changes in the string height following installation of the GK-3 pickup may cause the clearance between the strings and the pickup to change, which can result in poorer sensitivity.

### 3. Adjust the height of the pickup.

Insert the supplied spacers under the pickup until it is at the required height (do not yet remove the protective paper backing from the spacer's double-sided tape).

There are three types of pickup spacers, "A" (3 mm), "B" (1 mm) and "C" (0.25 mm); combine these as necessary to achieve the proper pickup height.

- \* The pickup height should be adjusted so that the distance between the pickup and the strings is about 1.0 mm (0.04") when the highest frets on the first and sixth strings are fingered. Check the height using the supplied clearance gauge (1.0 mm), and adjust the height as necessary (p. 11).
- \* If the first and sixth string heights differ greatly when the highest fret is fingered, compensate by adding the appropriate half-width or one-third width spacers until the clearance for both strings is the same.

When using an arch-top guitar, put the pickup cushions under the pickup spacers.

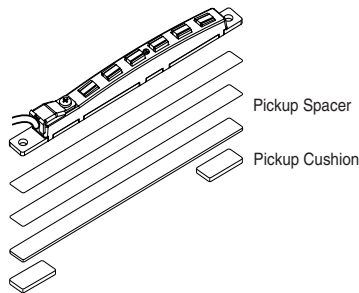

- \* Adjust the pickup cushion thickness as required, for example by using two pickup cushions.
- \* The pickup spacers and the pickup cushions are attached to the guitar with double-sided tape. When affixing the tape, however, the tape's thickness is reduced by 0.1 mm (0.004") when the backing of the tape is removed. Therefore, when using several pickup spacers, take this fact into account and set the height slightly higher to compensate.

### 4. Remove the strings from your guitar.

### 5. Remove the backing from the tapes for the pickup cushion, the pickup spacers, and the pickup, and carefully attach the pickup to the guitar.

- \* Although double-sided tape B is used for the pickup, if the adhesive capability seems insufficient after installation, use double-sided tape C instead.
- \* Using double-sided tape C strongly and securely attaches the pickup. Note, however, that once the pickup is attached with this tape, removal from the guitar becomes difficult and may result in damage to the guitar's finish.

### 6. Restring and tune the guitar, then carefully check the height of the divided pickup once more.

Measure with the clearance gauge to confirm that the clearances between the pickup and the strings are approximately 1.0 mm (0.04") when you press the first and sixth strings at the highest fret, play the strings and confirm that the strings do not come into contact with the pickup.

### 7. Take the steps below if the height of the divided pickup is not right.

- 1) Carefully examine the pickup in its current state, and add a suitable number of spacers if the pickup is too low, or remove one or more spacers if the pickup is too high.
  - 2) Remove the strings from the guitar.
  - 3) Remove the divided pickup from the guitar.
- \* Use care in handling the divided pickup; bending or twisting it may cause breaking in the coil elements. Carefully insert something thin and flat (like a table knife) under the Pickup from the sixth string side, then gently pry the pickup upwards.

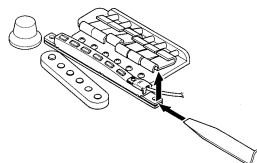

- 4) After removing the pickup, carefully remove the double-sided tape from the bottom of the pickup.
- 5) Adjust the height of the Pickup. If you wish to add a spacer, first completely remove the used double-sided tape from the top surface of the existing spacers, then add the new spacer. If you need to remove any spacers, remove the necessary number of spacers and completely remove the remaining double-sided tape from the top surface.
- 6) Attach two pieces of the new double-sided tape B to the bottom of the pickup.

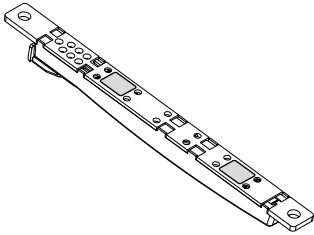

If when mounting the divided pickup you find that double-sided tape B lacks sufficient adhesion, use double-sided tape C.

- \* Using double-sided tape C strongly and securely attaches the pickup. Note, however, that once the pickup is attached with this tape, removal from the guitar becomes difficult and may result in damage to the guitar's finish.
- 7) Attach the pickup to the top of the spacer that is applied to the guitar side.
  - 8) Restring and tune the guitar, then check the height of the Divided Pickup again.
- \* Afterwards, you will need to adjust the pickup sensitivity when connecting to GK-compatible devices. However, you may find that the sensitivity level on the GK-compatible device is too high. In such instances, you may be able to correct the problem by widening the clearance between the strings and the pickup. Carry out Steps 1 through 8 again to lower the Pickup height slightly.

## How to Use the Clearance Gauge

The divided pickup height must be adjusted so that the clearance between each string and the divided pickup is 1.0 mm (0.04") when the highest fret is fingered.

The clearance gauge supplied with the GK-3 is 1.0 mm thick; place the gauge between the strings and the divided pickup as shown in the figure below, then check and adjust the height.

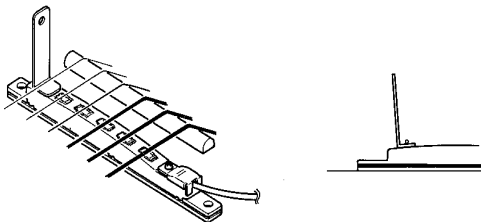

## ■ Attaching the Pickup with Screws

The steps for determining the position for attaching the pickup and for checking the height are exactly the same as when using the double-sided tape. Refer to “Attaching the Pickup with Double-Sided Tape” (p. 9).

\* *The height of the strings from the body must be no less than 13 mm (9/16”) when the pickup is attached with screws.*

**1. Determine the position for attaching the pickup. When you have determined the positioning, mark the position of the holes at each end of the pickup on the guitar’s body.**

**2. Remove the strings from the guitar.**

**3. Using a drill or similar means, open pilot holes where the attachment screws are to go in.**

\* *If the pilot holes are not made in the correct positions, then the pickup will not be attached in the correct position either. Use extra care when drilling the pilot holes.*

\* *Make the pilot holes approximately 2 mm (0.08”) in diameter.*

\* *Drill pilot holes slightly more than 2 mm in diameter if the guitar body is made of a particularly hard material.*

**4. Place the springs between the pilot holes and the pickup as shown in the figure below, then secure the pickup with the screws.**

**5. Restring and tune the guitar.**

**6. Adjust the height of the pickup.**

\* *The pickup height should be adjusted so that the distance between the pickup and the strings is about 1.0 mm (0.04”) when the highest frets on the first and sixth strings are fingered. Check the height using the supplied clearance gauge (1.0 mm).*

\* *Afterwards, when connecting to GK-compatible devices, you will need to adjust the pickup sensitivity again. However, you may find that the sensitivity level on the GK-compatible device is too high. In such instances, you may be able to correct the problem by widening the clearance between the strings and the pickup, so try lowering the Pickup height slightly to see if this approach is effective.*

\* *If the springs are too long, use a pair of wire clippers to cut them to the correct size.*

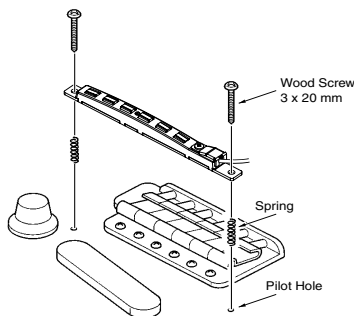

## ■ Attaching the Pickup with the Pickup Holder

### 1. Attach the divided pickup to the pickup holder.

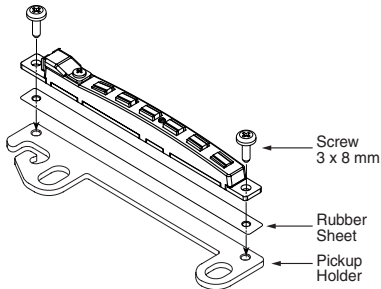

\* Tighten the screws until the pickup lightly presses down against the rubber sheet.

### 2. Remove the strings and the bridge from the guitar.

### 3. Lower the two bridge height adjustment screws of the guitar approximately 2 mm (0.08").

\* If the bridge is of the type whereby the posts themselves are adjusted, then lower the post height by 2 mm (0.08").

### 4. Place the holder on the posts, then cover it with the bridge.

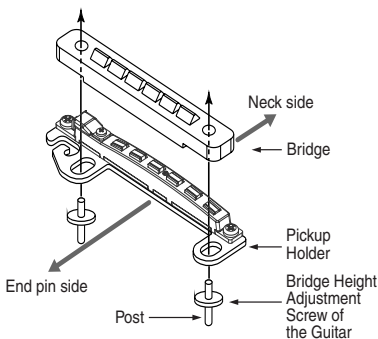

### 5. Restring and tune the guitar.

\* Tune the strings with the divided pickup adjusted to the optimal position (where all strings ride over their respective yokes).

### 6. Adjust the height of the pickup.

- \* The pickup height should be adjusted so that the distance between the pickup and the strings is about 1.0 mm (0.04") when the highest frets on the first and sixth strings are fingered. Check the height using the supplied clearance gauge (1.0 mm).
- \* If the pickup ends up being too low, use two rubber sheets layered together. But the pickup still sits too low even after layering the two rubber sheets, then use the rubber tubes.

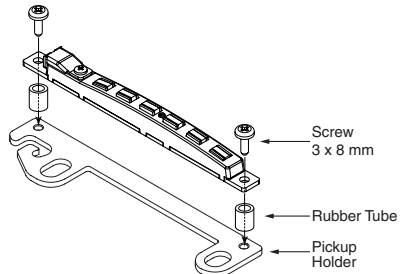

- \* If the pickup position is too high, insert the included 13-mm washers between the pickup holder and the bridge.

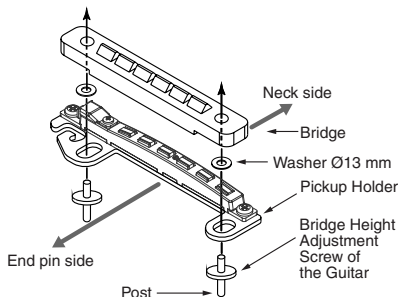

- \* Afterwards, when connecting to GK-compatible devices, you will need to adjust the pickup sensitivity again. However, you may find that the sensitivity level on the GK-compatible device is too high. In such instances, you may be able to correct the problem by widening the clearance between the strings and the pickup, so try lowering the Pickup height slightly to see if this approach is effective.

---

## **Checking and Finely Adjusting the Pickup Height**

---

Use the clearance gauge to confirm that the clearance between each string and the pickup is about 1 mm. If the gap is greater than 1 mm (0.04"), make fine adjustments to the height of the pickup itself and to the pickup curve (refer to p. 8).

---

## Attaching the Controller

---

There are two ways to attach the controller.

### ● Attaching the Controller Unit with Holder (p. 16)

With this method, the holder is secured using the guitar's strap pin. This permits easy installation with no modification of the guitar required.

### ● Attaching the Controller Unit with Double-Sided Tape and Screws (p. 17)

This allows you to position the controller where you like on the guitar and, by not using the holder, reduce the thickness of the controller. However, attaching the controller with the tape and screw is difficult to do with arched top guitars.

## ■ Adjusting the Length of the Pickup Cable

Place the controller where it is actually to be attached to the guitar to check the pickup cable length. If the cable is too long, wind it up in the space behind the controller.

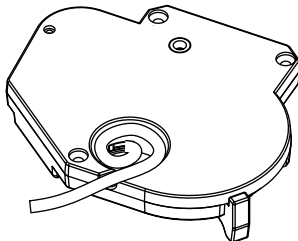

## ■ Attaching with the Holder

1. Remove three screws from the underside of the controller, then attach the GK-3 to holder "A."

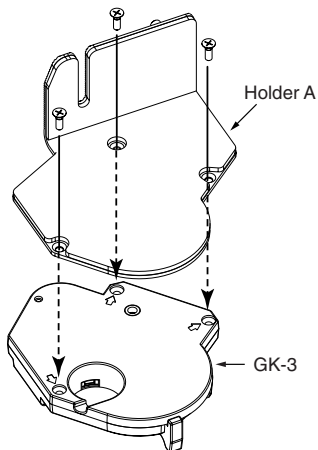

2. Loosen the guitar's end pin, and insert holder "A."

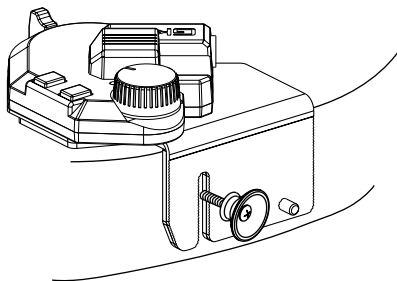

3. Screw in the end pin.

4. Attach holder "B" so that the guitar body is sandwiched between the two holders.

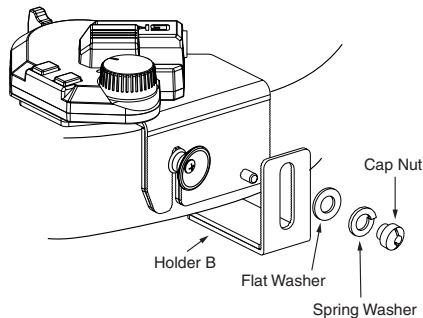

5. Tighten holders "A" and "B" using the flat washer, the spring washer, and the cap nut.

\* When attaching the GK-3 to an arched top guitar, place the cushion between the guitar and holder "A."

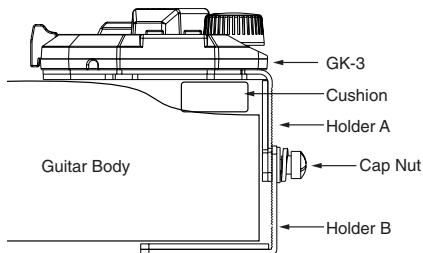

## ■ Attaching with Double-sided Tape and a Screw

1. Place the controller in an appropriate position on the guitar surface to determine where it is to be attached. Pay attention to the following points at this time.

- Install on a level surface.
- Position the controller so it does not interfere with your playing.
- If your guitar includes a fine tuning control, position the controller so it does not interfere with operation of the fine tuning.
- Position the controller so you can comfortably operate the select switch, the S1 and S2 switches, and other controls.
- Position the controller so that it does not place undue strain on the Normal Pickup Input jack, divided pickup, or GK connector cables.

- \* *Make sure that the plugs connected to the GK connector and Normal Pickup Input jack do not stick out, as this may result in damage should undue strain be placed on the GK connector or Normal Pickup Input jack.*

2. Once the controller position has been determined, place the controller in position and carefully drill a pilot hole in the guitar body where the controller's attachment hole is located.

- \* *The diameter of the hole should be about 2 mm (0.08 inches).*
- \* *Confirm that there are no other problems in attaching the controller before drilling the pilot hole.*

3. After attaching the double-sided tape A to the underside of the Controller, attach the controller to the guitar.

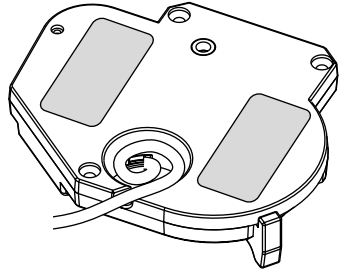

4. Secure the controller with the supplied screw (flat-head, 3x16 mm).

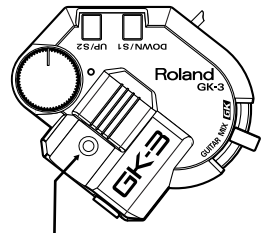

Put the screw (flat-head, 3x16 mm) through this hole.

- \* *If you'd rather not drill a hole in your guitar, you can secure the Controller using only the double-sided tape or the holders. However, if only the double-sided tape is used to secure the unit, shocks from rough handling during performances and from use over an extended period will cause the tape to deteriorate, with the GK-3 shifting out of position as a result. Furthermore, if the finish on your guitar is less than perfect, you may discover that the finish is also removed when you later remove the tape.*

# How to Connect the GK-3

- \* To prevent malfunction and/or damage to speakers or other devices, always turn down the volume, and turn off the power on all devices before making any connections.
- \* When connection cables with resistors are used, the volume level of equipment connected to the inputs (Normal Pickup Input jack) may be low. If this happens, use connection cables that do not contain resistors, such as those from the Roland PCS series.
- \* When all devices are properly connected, turn on the power to the various devices in the order specified below. Turning on devices in the wrong order may result in malfunction and/or damage to speakers and other devices.

- 1. Make sure that the power to the GK-compatible device being connected is turned off, then connect the device to the GK-3's GK connector using the GK cable.**

- \* The GK cable is a locking cable. When disconnecting the cable, do not pull on it with undue force, but instead release the lock and gently disconnect the cable. You can disconnect the cable simply and easily by holding down the locking portion with your thumb and gently pulling on the plug.

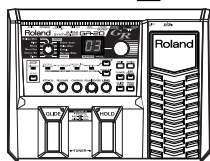
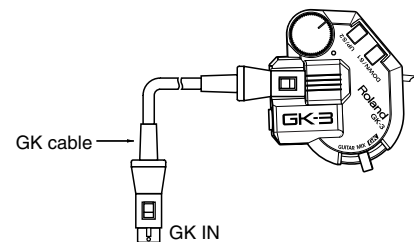

GK-compatible device



Connect the GK-3 only with dedicated GK cable (supplied with Roland GK-compatible devices and optional GK cables sold by Roland). Use of any other cable may result in damage or malfunction.

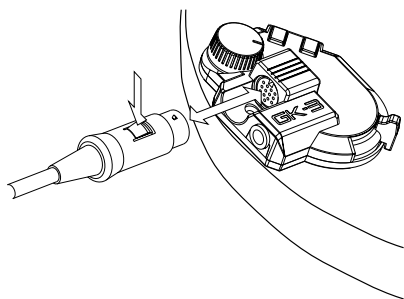

- 2. Use the included Normal guitar cable to connect the output jack on the guitar to the GK-3's Normal Pickup input jack.**

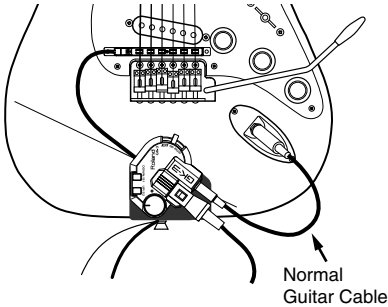

- \* This connection is necessary not only for playing the guitar's normal (straight) sound as well as the guitar's straight sound mixed with the synthesizer sound, but also for connecting the guitar's ground and the GK-3's ground. Even if you are not going to use the guitar's straight sound at all, always make this connection because of the noise reduction benefits it provides.

- 3. Turn on the power to the connected GK-compatible device.**

The Power indicator on the Controller lights up. Now, when you play your guitar you'll hear the sound of the connected GK-compatible device.

- \* The power indicator lights up when the GK-3 and the GK-compatible device are properly connected with a GK cable and the power to the GK-compatible device is turned on.
- \* Always make sure to have the volume level turned down before switching on power. Even with the volume all the way down, you may still hear some sound when the power is switched on, but this is normal, and does not indicate a malfunction.
- \* Before playing, be sure to wrap the cable around the guitar strap near the end pin. This will prevent the excess strain on the cable that can end up damaging the guitar or the GK-3.

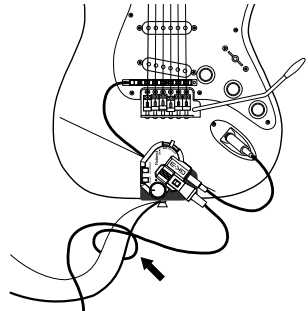

# Specifications

## GK-3: Divided Pickup

### ● Controls

GK Volume  
DOWN/S1 Switch  
UP/S2 Switch  
Select Switch

### ● Indicator

Power Indicator

### ● Connectors

GK Connector  
Normal Pickup Input Jack

### ● Weight

60 g / 3 oz

### ● Accessories

Normal Guitar Cable  
Parts for installation  
Owner's Manual

### ● Options

GK Cables: GKC-3, GKC-5, GKC-10  
Unit Selector: US-20

\* *In the interest of product development, the specifications and/or appearance of this unit are subject to change without prior notice.*

### ● Dimensions

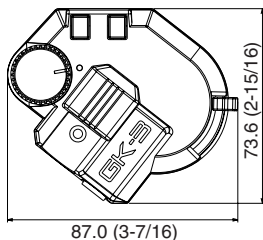

Unit : mm (inch)

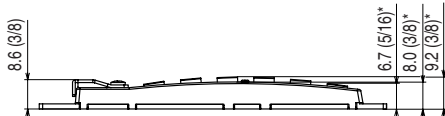
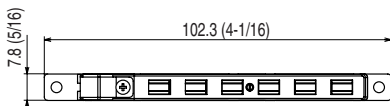

\*...with yokes at maximum height

Unit : mm (inch)



Manufacturer: Roland Corporation  
2036-1 Nakagawa, Hosoe-cho, Kita-ku, Hamamatsu, Shizuoka 431-1304, JAPAN  
Importer: Roland Corporation  
ENA 23 Zone 1 nr. 1620 Klaus-Michael Kuehnelaan 13, 2440 Geel, BELGIUM

For EU Countries



Manufacturer: Roland Corporation  
2036-1 Nakagawa, Hosoe-cho, Kita-ku, Hamamatsu, Shizuoka 431-1304, JAPAN  
Importer: Roland Europe Group Limited  
Hive 2, 1530 Arlington Business Park, Theale, Reading, Berkshire. RG7 4SA United Kingdom

For the U.K.





## Roland Service Centers and Distributors

When you need repair service, access this URL and find your nearest Roland Service Center or authorized Roland distributor in your country.

<https://roland.cm/service>



**For EU Countries**

- UK** This symbol indicates that in EU countries, this product must be collected separately from household waste, as defined in each region. Products bearing this symbol must not be discarded together with household waste.
- DE** Dieses Symbol bedeutet, dass dieses Produkt in EU-Ländern getrennt vom Hausmüll gesammelt werden muss gemäß den regionalen Bestimmungen. Mit diesem Symbol gekennzeichnete Produkte dürfen nicht zusammen mit dem Hausmüll entsorgt werden.
- FR** Ce symbole indique que dans les pays de l'Union européenne, ce produit doit être collecté séparément des ordures ménagères selon les directives en vigueur dans chacun de ces pays. Les produits portant ce symbole ne doivent pas être mis au rebut avec les ordures ménagères.
- IT** Questo simbolo indica che nei paesi della Comunità europea questo prodotto deve essere smaltito separatamente dai normali rifiuti domestici, secondo la legislazione in vigore in ciascun paese. I prodotti che riportano questo simbolo non devono essere smaltiti insieme ai rifiuti domestici.  
Ai sensi dell'art. 13 del D.Lgs. 25 luglio 2005 n. 151.
- ES** Este símbolo indica que en los países de la Unión Europea este producto debe recogerse aparte de los residuos domésticos, tal como está regulado en cada zona. Los productos con este símbolo no se deben depositar con los residuos domésticos.
- PT** Este símbolo indica que nos países da UE, a recolha deste produto deverá ser feita separadamente do lixo doméstico, de acordo com os regulamentos de cada região. Os produtos que apresentem este símbolo não deverão ser eliminados juntamente com o lixo doméstico.
- NL** Dit symbool geeft aan dat in landen van de EU dit product gescheiden van huishoudelijk afval moet worden aangeboden, zoals bepaald per gemeente of regio. Producten die van dit symbool zijn voorzien, mogen niet samen met huishoudelijk afval worden verwijderd.
- DK** Dette symbol angiver, at i EU-lande skal dette produkt opsamles adskilt fra husholdningsaffald, som defineret i hver enkelt region. Produkter med dette symbol må ikke smides ud sammen med husholdningsaffald.
- NO** Dette symbolet indikerer at produktet må behandles som spesialavfall i EU-land, iht. til retningslinjer for den enkelte regionen, og ikke kastes sammen med vanlig husholdningsavfall. Produkter som er merket med dette symbolet, må ikke kastes sammen med vanlig husholdningsavfall.
- SE** Symbolen anger att i EU-länder måste den här produkten kasseras separat från hushållsavfall, i enlighet med varje regions bestämmelser. Produkter med den här symbolen får inte kasseras tillsammans med hushållsavfall.
- FI** Tämä merkintä ilmaisee, että tuote on EU-maissa kerättävä erillään kotitalousjätteistä kunkin alueen voimassa olevien määräysten mukaisesti. Tällä merkinnällä varustettuja tuotteita ei saa hävittää kotitalousjätteen mukana.
- HU** Ez a szimbólum azt jelenti, hogy az Európai Unióban ezt a terméket a háztartási hulladéktól elkülönítve, az adott régióban érvényes szabályozás szerint kell gyűjteni. Az ezzel a szimbóllummal ellátott termékeket nem szabad a háztartási hulladék közé dobni.
- PL** Symbol oznacza, że zgodnie z regulacjami w odpowiednim regionie, w krajach UE produktu nie należy wyrzucać z odpadami domowymi. Produktów opatrzonych tym symbolem nie można utylizować razem z odpadami domowymi.
- CZ** Tento symbol udává, že v zemích EU musí být tento výrobek sbíráán odděleně od domácího odpadu, jak je určeno pro každý region. Výrobky nesoucí tento symbol se nesmí vyhadzovat spolu s domácím odpadem.
- SK** Tento symbol vyjadruje, že v krajinách EÚ sa musí zber tohto produktu vykonávať oddelene od domového odpadu, podľa nariadení platných v konkrétnej krajine. Produkty s týmto symbolom sa nesmú vyhazovať spolu s domovým odpadom.
- EE** See sümbol näitab, et EL-i maades tuleb see toode olemprügist eraldi koguda, nii nagu on igas piirkonnas määratletud. Selle sümboliga märgitud tooteid ei tohi ära visata koos olmeprügiga.
- LT** Šis simbolis rodo, kad ES šalyse šis produktas turi būti surenkamas atskirai nuo buitinių atliekų, kaip nustatyta kiekviename regione. Šiuo simboliu paženklinoti produktai neturi būti išmetami kartu su buitiniems atliekomis.
- LV** Šis simbols norāda, ka ES valstīs šo produktu jāievāc atsevišķi no mājsaimniecības atkritumiem, kā noteikts katrā reģionā. Produkta ar šo simbolu nedrīkst iznest kopā ar mājsaimniecības atkritumiem.
- SI** Ta simbol označuje, da je treba proizvod v državih EU zbirati ločeno od gospodinskih odpadkov, tako kot je določeno v vsaki regiji. Proizvoda s tem znakom ni dovoljeno odlagati skupaj z gospodinskimi odpadki.
- GR** Το σύμβολο αυτό υποδηλώνει ότι στις χώρες της Ε.Ε. το συγκεκριμένο προϊόν πρέπει να συλλέγεται χωριστά από τα υπόλοιπα οικιακά απορρίμματα, σύμφωνα με όσα προβλέπονται σε κάθε περιοχή. Τα προϊόντα που φέρουν το συγκεκριμένο σύμβολο δεν πρέπει να απορρίπτονται μαζί με τα οικιακά απορρίμματα.