

GODOX设计文件图注

项目名称	MF-R76 微距环形闪光灯 说明书		
项目类型	<input type="checkbox"/> 彩盒 <input type="checkbox"/> 彩卡 <input type="checkbox"/> 白盒 <input type="checkbox"/> 贴纸 <input checked="" type="checkbox"/> 说明书 <input type="checkbox"/> 内托 <input type="checkbox"/> 胶盒 <input type="checkbox"/> 吸塑 <input type="checkbox"/> 其他:		
产品料号	705-MFR760-00	版本	A
展开尺寸(mm)		成品尺寸(mm)	100*140mm
尺寸公差	± 2mm		
材质	105G 铜版纸		
工艺说明	骑马钉		
备注/色值	单色, 黑色印刷		
设计师	柳杨	校对	吴水宁

Godox

MF-R76

MACRO RING FLASH 微距环形闪光灯

合格证
QC PASS

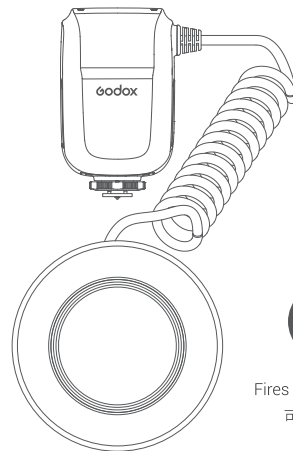

Fires Independently
可独立闪光

深圳市神牛摄影器材有限公司

地址: 深圳市宝安区福海街道塘尾社区耀川工业区厂房2栋
电话: 0755-29609320(8062) 传真: 0755-25723423 邮箱: godox@godox.com

GODOX Photo Equipment Co., Ltd.

Add: Building 2, Yaochuan Industrial Zone, Tangwei Community, Fuhai Street, Bao'an District, Shenzhen, 518103 China Tel: +86-755-29609320(8062)
Fax: +86-755-25723423 E-mail: godox@godox.com

说明手册 | Instruction Manual

在使用本产品之前, 请务必仔细阅读使用说明书。请务必妥善保管好使用说明书, 以便日后查阅。
Before using this product: Please read this user manual carefully in order to ensure your safety and the proper operation of this product. Keep for future reference.

godox.com

Made in China



前言

感谢您购买神牛产品-微距环形闪光灯MF-R76!

MF-R76是一款用于近距离摄影的环形闪光灯。结构紧凑,拥有环形闪光灯体与简便控制器。A/B灯管能够的独立闪光,还能设置精准闪光功率输出,实现精准控光,给摄影创作增加多种光线选择,创意无限。该机应用范围广泛,适用于昆虫摄影、植物摄影、珠宝摄影、口腔牙科摄影等微距拍摄场景。

主要特点:

接近拍摄时机身不会遮挡闪光灯的灯光,闪光无暗角无阴影。

多档位精佳控制功率,可在1/1全功率-1/128以1/3EV调节。

闪光指数GN14,手动闪光输出稳定,瞬间补光,细节与层次兼备。

全功率闪光回电仅需1.5s,随时捕捉精彩瞬间。

锂电池供电,续航能力强大,1/1全功率闪光次数多达660次。

环形灯体安装方便,灵活性高,适用于49mm-77mm口径的相机镜头。

2个辅助对焦灯设计,10档亮度调节,在黑暗环境下更容易对焦。

极简用户界面,操作轻松便捷,给予舒适的体验感。

主要特点:

请保持干燥。

请勿让儿童接触本产品。

本产品没有防水功能,在雨天及潮湿环境下请注意防水。

请勿放置在超过50度的高温环境中。

请勿私自拆卸产品,如产品出现故障须由本公司或授权的维修人员进行检查维修。

禁止拆卸、撞击、挤压或投入火中,若出现严重鼓胀,请勿继续使用。

请勿将闪光灯灯头正对人眼闪光(特别是婴儿的眼睛),否则可能会在短时间内造成视力障碍。

请勿在化学品、可燃性气体或其他特殊物质附近使用闪光灯,这些物质在特殊情况下可能对闪光灯发出的瞬间强光敏感,有可能导致火灾或电磁干扰。在这些场合下,请注意相关警告标识。

请勿在多尘或潮湿的地方使用或存放本设备,以防止发生火灾、过热、触电和烫伤等情况。

若发生任何故障,请立即关闭闪光灯电源。

部件名称

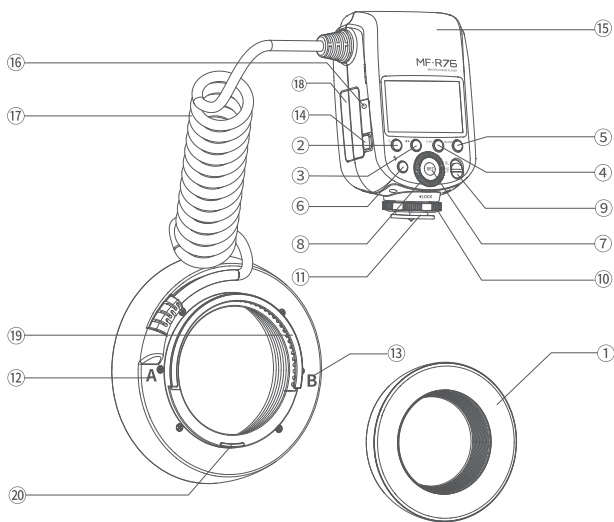

- | | |
|---------------------|---------------|
| 01. 灯头 | 11. 热靴 |
| 02. 辅助对焦灯按键(1~10调节) | 12. 闪光管A |
| 03. A/B选择按键 | 13. 闪光管B |
| 04. 自定义功能按键 | 14. 取电池按钮 |
| 05. RATIO按键 | 15. 控制器主体 |
| 06. 试闪按键 | 16. 2.5mm同步插孔 |
| 07. SET按键 | 17. 连接线 |
| 08. 调节拨轮 | 18. 锂电池 |
| 09. ON/OFF 开关键 | 19. 镜头适配环接口 |
| 10. 锁定环 | 20. 拆卸卡口 |

包装清单

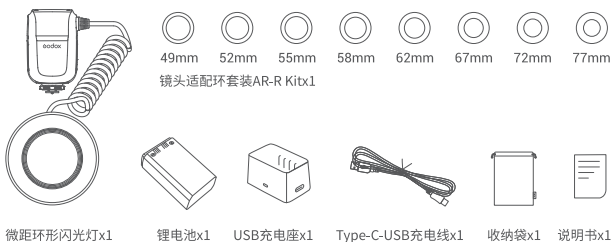

电池

1. 本品采用7.2V/2600mAh 锂电池,支持反复充放电660次,使用寿命长。
 2. 安全可靠,内置电路有过充保护、过放保护、过流保护、短路保护。
 3. 使用电池充电器VC1(5V 2A,需另购)只需3.5个小时左右。
- 小提示:微距环形闪光灯MF-R76通用神牛V1锂电池VB26和神牛AD100Pro锂电池WB100(7.2V/2600mAh或7.2V/3200mAh)。

● 注意事项

1. 避免正负极短路。
2. 电池没有防水功能,不要把电池浸泡在雾、水中。
3. 放置于儿童不易接触的地方。
4. 电池充电不要放置超过24小时。
5. 电池应放置于凉爽、干燥及通风的地方存储。
6. 电池不要靠近和放置于火中。
7. 电池使用报废后请按当地的规定处理。
8. 如果电池超过3个月不使用,请将电池充满电再进行使用。
9. 长期不使用,请充电至60%左右再放置。
10. 反复充放电500次以上或电池使用3年以上,建议更换新电池。

装卸电池

1. 拆卸电池(图一) 用您的拇指长按电池按钮,往右推电池,便可取出电池。
2. 安装电池(图二) 按照电池指示方向将锂电池插入电池仓,直至扣件卡住即可。

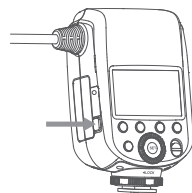

(图一)

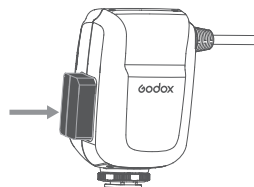

(图二)

装卸控制器

1. 松开锁定环

按照逆时针方向旋转松开锁定环。

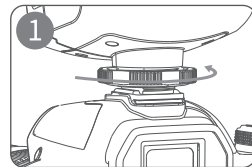

2. 安装控制器

滑动控制器热靴使其完全插入相机热靴插座中。

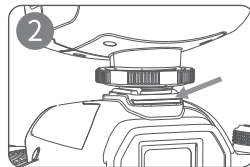

3. 拧紧锁定环

按照顺时针方向旋转拧紧锁定环。

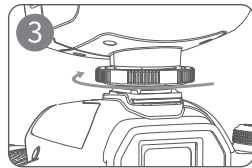

装卸环形闪光灯

1. 安装镜头适配环

将所需的镜头适配环,按照顺时针方向旋转安装到相机镜头前。

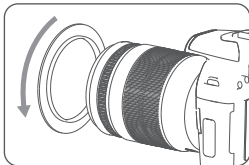

小提示:本产品配有8种规格的适配环,与相机镜头颈圈相符:
49mm、52mm、55mm、58mm、62mm、
67mm、72mm和77mm。

2. 安装环形闪光灯

将装有适配环的相机镜头对准适配环连接口,轻轻卡上即可。

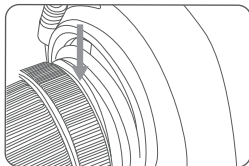

注:装好的环形灯可以360°旋转,属于正常安装情况。

3. 拆卸环形闪光灯

找到环形灯背面的拆卸卡口,稍微用力向上提拉,然后同时往右轻轻旋转,环形闪光灯随之脱离。

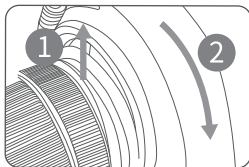

操作说明

打开电源开关

将ON/OFF 开关键拨至<ON>,即为开机。拨至<OFF>,即为关机。

辅助对焦灯

短按辅助对焦灯按键,实现打开或关闭辅助对焦灯。

造型灯调节:打开辅助对焦灯后,短按SET按键进入造型灯调节界面,旋转调节拨轮进行1-10级调节。

A灯/B灯设置切换

短按A灯/B灯选择按键,可切换A灯/B灯设置界面。切换到A灯或B灯,您都可直接旋转调节拨轮,在1/1全功率-1/128功率间设置闪光输出。

注:每档以1/3档为增量。

自定义功能设置

1. 背光休眠设置

本产品设有背光休眠设置,以避免长时间不操作灯体消耗电池电量。

通过短按< C.Fn >自定义功能按键进入自定义设置界面,显示屏显示“BL”(Background Light 表示背景光)和“休眠时间”。本产品出厂模式休眠时间设置为10s,拨动调节拨轮即可更改睡眠时间或关闭休眠时间,设置完毕按< C.Fn >自定义功能按键返回上一级界面。

背光休眠设置	说明
ON	背光处于一直点亮状态
OFF	表示背光关闭,界面为没有背景光状态。
10s	无人操作,10s后界面变为无背景光状态。
20s	无人操作,20s后界面变为无背景光状态。

2. 自动休眠设置

本产品设有自动休眠功能, 以避免长时间不操作灯体消耗电池电量。

通过短按< C.Fn > 自定义功能按键进入自定义设置界面, 显示屏显示“SL”(Sleep表示休眠)和“休眠时间”。本产品出厂模式休眠时间设置为30分钟, 拨动调节拨轮即可更改睡眠时间或关闭休眠时间, 设置完毕按< C.Fn > 自定义功能按键返回上一级界面。

自动休眠设置	说明
OFF	表示休眠时间已关闭, 闪光灯不会自动休眠。
30min	30分钟无人操作, 机体自动休眠。 按任意键可唤醒界面。
60min	60分钟无人操作, 机体自动休眠, 按任意键可唤醒界面。

闪光功率设置

短按RATIO按键, 可实现AB整体闪光功率调节界面—A、B闪光功率单独调节界面—A灯闪光功率调节界面循环切换。转动调节拨轮, 您可以在在1/1全功率至1/128功率间以1/3档为增量手动设置闪光输出。可使用四种方式之一使闪光灯闪光:

1. A和B以相同功率闪光;
2. A和B以不同功率闪光;
3. 只有A闪光;
4. 只有B闪光。

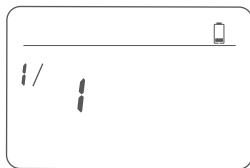

AB整体闪光功率调节界面

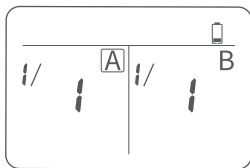

A、B闪光功率单独调节界面

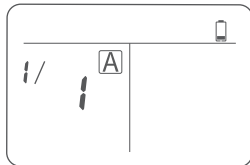

A灯闪光功率调节界面

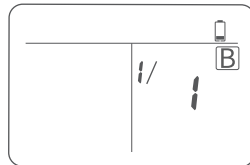

B灯闪光功率调节界面

注意: A、B闪光功率单独调节界面默认A灯功率调节, 调节B灯闪光功率, 需切换至B灯后方可旋转调节拨轮进行功率调节。

兼容相机列表

适用相机类型: 佳能、尼康、索尼、富士、奥林巴斯、松下、宾得。

过热保护功能

为防止闪光灯过热并损坏, 请勿在1/1功率时进行超过35次的快速连续闪光。35次连续闪光后, 要让闪光灯至少冷却10分钟。如您在进行超过35次连续闪光后马上继续进行多次闪光, 内部的过热保护功能可能会被激活, 过热保护启动后, 显示屏右上角显示< >。如果发生这种现象, 请让闪光灯冷却约10分钟, 闪光灯便会恢复正常。

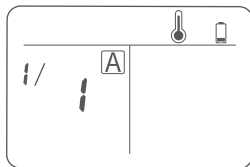

激活过热保护功能的连续闪光次数

档位	连续闪光次数
1/1	35
1/2	60
1/4	120
1/8	196
1/16	285
1/32	465
1/64	820
1/128	1750

其他保护

LCD显示	警示内容
E0	设备内部温度传感器有问题, 请维修。
E1	闪光灯回电系统出现问题, 无法回电引闪, 请重新开机, 如无法解决请维修。
E2	设备内温度过高, 请停止引闪10分钟。
E3	闪光管两端电压过高, 请维修。

规格参数

名称	微距环形闪光灯
型号	MF-R76
闪光指数	GN14/46(ISO 100、以米/英尺为单位)
兼容相机	佳能、尼康、索尼、富士、奥林巴斯、松下、宾得
锂电池	7.2V/2600mAh
闪光灯功率(1/1档位)	76Ws
辅助对焦灯功率	0.7W*2
辅助对焦灯色温	5000K
闪光控制	1/1-1/128(以1/3档为增量调节)
闪光持续时间	1/300s~1/20000s
灯体内径	77mm
照射距离	3cm~1.5m
回电时间	0.1-1.5s
全功率闪光次数	660次
工作环境温度	-10~50°C
环形闪光灯尺寸	130*130*27毫米/5.1*5.1*1英寸
控制器尺寸	120*70*50毫米/4.7*2.7*1.9英寸
净重	≈458克/16.1盎司
净重(含电池)	≈577克/20.3盎司

上述所有的规格均基于神牛测试标准。设计和规格如有变更, 恕不另行通知。

维护保养

在工作时,如发现异常,应立即关掉电源,查明原因。

灯体应避免震动,平时注意表面除尘。

灯体稍有发热为正常现象。

所有维修概由本厂指定的可供原配件的维修部负责。

1年保修,消耗品如灯管等,不在1年保修范围。

经发现,擅自检修此闪光环形灯,将取消一年保修期,维修需要收取相关费用。

如果本品出现故障或者被水淋湿,在专业人员维修后方可继续使用。如有技术更改,恕不另行通知。

Foreword

Thank you for purchasing!

MF-R76 is a macro ring flash with compact structure of flash body and convenient controller. The A/B flash tube can fire independently, set flash power output to achieve precise brightness control, and provide a variety of options and creations. It can be widely used in macro shooting scenes such as insect photography, plant photography, jewelry photography and dental photography.

Features

No vignetting and no shadows in macro shooting.

Accurate power adjustment from 1/1 full power to 1/128 at 1/3E

Vincement each stop.

Guide No. GN14, stable manual flash output and instant filling.

Merely 1.5s full-power flash recycling time.

Lithium battery power supply, up to 660 flash times in 1/1 full power.

Easy to install and suitable for camera lens with a diameter of 49mm-77mm.

Two LED Focus Assist Beam are designed with 10 levels of brightness adjustment.

Simple user's interface, convenient and comfortable operation.

Warning

△ Always keep this product dry.

△ Keep out of reach of children.

△ As this product is not waterproof, do not use in rain or in damp conditions.

△ Do not leave or store the flash unit if the ambient temperature reads over 50 C. Otherwise the electronic parts may be damaged.

△ Do not disassemble. Should repairs become necessary, this product must be sent to an authorized maintenance center.

△ Stop using this product if it breaks open due to extrusion, falling or strong hit. Otherwise, electric shock may occur if you touch the electronic parts inside it.

△ Do not fire the flash directly into the eyes (especially those of babies) within short distances. Otherwise visual impairment may occur.

△ Do not use the flash unit in the presence of flammable gases,

chemicals and other similar materials. In certain circumstance, these materials may be sensitive to the strong light emitting from this flash unit and fire or electromagnetic interference may result.

⚠ Turn off the devices immediately in the event of malfunction.

Name of Parts

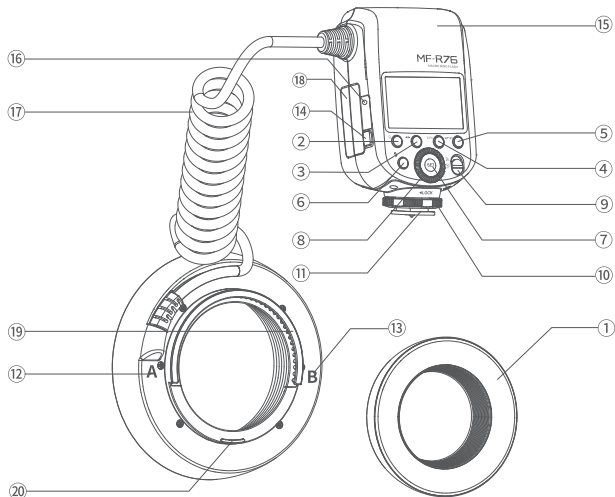

- | | |
|---|----------------------------------|
| 01. Flash head | 11. Hotshoe |
| 02.LED Focus Assist Beam button
(1~10 stops) | 12. Flash tube A |
| 03.A /B group selection dial | 13. Flash tube B |
| 04. C.Fn: Setting Custom Functions button | 14. Battery remove button |
| 05. RATIO button | 15. Controller |
| 06. Flash trigger button | 16.3.5mm sync cord jack |
| 07.SET button | 17. Connecting cable |
| 08. Select dial | 18. Lithium battery |
| 09. ON/OFF Power switch button | 19. Adapter ring connecting port |
| 10. Lock ring | 20.Detaching mount |

What's in the Box

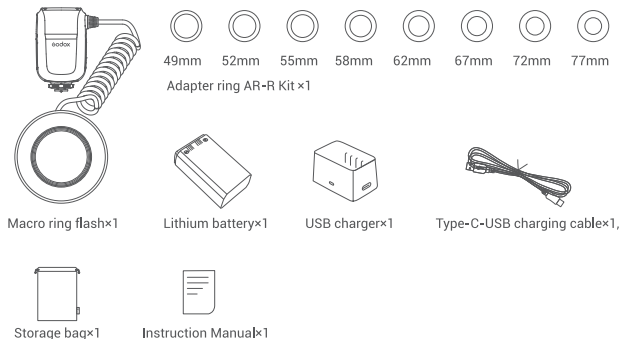

Battery

- 1.This product uses 7.2V/2600mAh lithium battery which has long runtime. The available charge-and-discharge times are 480.
- 2.It is reliably safe. The inner circuit is against overcharge, overdischarge, overcurrent, and short circuit.
- 3.Take only 3.5 hours to fully charge the battery by using battery charger. VC1(5V 2A,optional)

Tips: Macro ring flash MF-R76 is compatible with Godox V1 lithium battery VB26 and AD100Pro lithium battery WB100 (7.2V/2600mAh or 7.2V/3200mAh)

Cautions

1. Do not short circuit.
2. Do not expose to rain or immerse into water. This battery is not water proof.
3. Keep out of reach of children.
4. No over 24 hours' continuous charging.
5. Store in dry, cool, ventilated places.
6. Do not put aside or into fire.
7. Dead batteries should be disposed according to local regulations.
8. If the battery had ceased using for over 3 months, please make a full recharge.
9. Please charge the battery to approx. 60% before being placed for long time.
10. Please replace a new battery after charging-and-discharging over 500 times or being used over 3 years.

Loading and Unloading the Battery

1. Unloading(1)

Long press the battery remove button and push right the battery to unload it.

2. Loading(2)

Insert the lithium battery according to the direction, push in until it is locked.

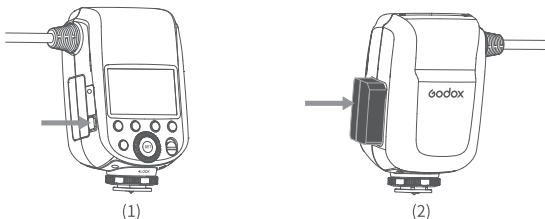

Installation and Disassembly of the Controller

1. Loosening the lock ring

Rotate anticlockwise to loosen the lock ring.

2. Installing the controller

Slide the hotshoe to completely insert it into the camera's socket.

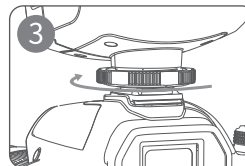
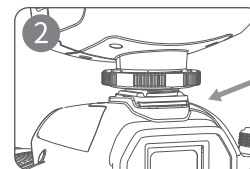
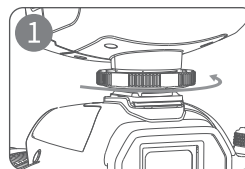

3. Securing the lock ring

Rotate clockwise to secure the lock ring.

Installation and Disassembly of the ring flash

1. Installing the lens adapter ring

Rotate clockwise the proper adapter ring and mount it to the front of the lens.

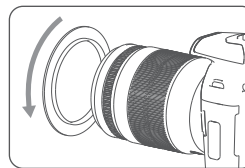

Tips: There are 8 adapter rings applicable to MF-R76: 49mm, 52mm, 55mm, 58mm, 62mm, 67mm, 72mm and 77mm.

2. Installing the ring flash

Insert the lens with adapter ring into the adapter ring connecting port until it is locked.

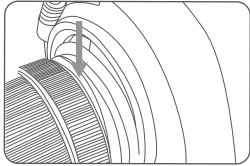

Note: It is normal that the mounted ring flash can be rotated 360°.

3. Disassembling the ring flash

Slightly pull out the remove buckle on the back, and then rotate to the right to remove the ring flash.

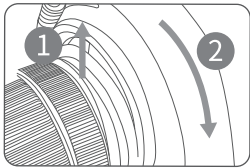

Operating Instructions

Power switch

Toggle ON/OFF Power switch button to <ON> to power on, and <OFF> to power off.

Focus Assist Beam

Short press the LED Focus Assist Beam button to turn on or turn off the Focus Assist Beam.

Modeling light adjustment: Turn on the Focus Assist Beam short press SET button to enter the setting interface, then turn the select dial to adjust in 1-10 stops.

A/B flash setting switch

Short press A/B flash selection dial to switch to A/B flash setting interface, turn the select dial to set flash output from 1/1 full power to 1/128 with 1/3 increment at each stop.

C.Fn: Setting Custom Functions

1. Backlight dormancy setting

This product has backlight dormancy function to avoid battery consumption in long period of idle use.

Short press <C.Fn > C.Fn button to enter the custom function setting interface, with "BL"(Backlight) and "dormancy time" displayed on the LCD panel. The dormancy time is set to 10s by default. You can change or turn off the dormancy time by turning the select dial, after which press the <C.Fn > C.Fn button to return to the previous interface.

Backlight Dormancy Setting	Description
ON	The backlight is constantly on.
OFF	The backlight is turned off, it is in the state of no backlight.
10s	Idle time before entering backlight dormancy mode is set to 10s.
20s	Idle time before entering backlight dormancy mode is set to 20s.

2. Auto sleep setting

This product has auto sleep function to avoid battery consumption in long period of idle use.

Short press <C.Fn > C.Fn button to enter the custom function setting interface, with "SL"(Sleep) and "sleeping time" displayed on the LCD panel. The sleeping time is set to 30min by default. You can change or turn off the sleeping time by turning the select dial, after which press the <C.Fn > C.Fn button to return to the previous interface.

Auto sleep setting	Description
OFF	The Sleep Function is turned off. The flash unit will not automatically enter sleep mode.
30min	Idle time before entering sleep mode is set to 30 minutes. Press any button to waken.
60min	Idle time before entering sleep mode is set to 60 minutes. Press any button to waken.

Flash power setting

Short press **RATIO** button to switch among **AB flash power common adjustment—A. B flash power individual adjustment—A flash power adjustment—B group flash power adjustment**. You can set the manual flash output from 1/1 full power to 1/128 with 1/3 increment at each stop by turning the select dial. The flash can fire in one of the four modes: **1. A group fires in the same power with B group, 2. A group fires in the different power with B group, 3. Only A group fires, 4. Only B group fires.**

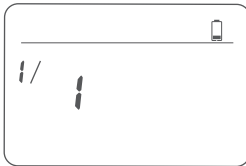

AB flash power common adjustment

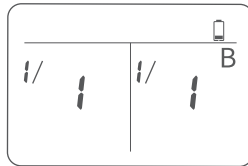

A, B flash power individual adjustment

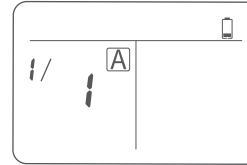

A flash power adjustment

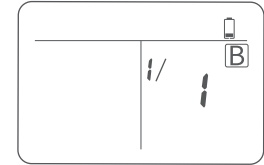

B flash power adjustment

Note: The A, B flash power individual adjustment interface displays A flash power adjustment by default, for B flash power adjustment, you need to switch to B flash then turn the select dial.

Compatible Camera Models

This flash unit can be used on the following camera models: Canon, Nikon, Sony, Fuji, Olympus, Panasonic, Pentax.

Over-Temperature Protection

To avoid overheating and deteriorating the flash head, do not fire more than 35 continuous flashes in fast succession at 1/1 full power. After 35 continuous flashes, allow a rest time of at least 10 minutes.

If you fire more than 35 continuous flashes and then fire more flashes in short intervals, the inner overtemperature protection function may be activated and  is shown on the LCD panel. If this occurs, allow a rest time of about 10 minutes, and the flash unit will then return to normal.

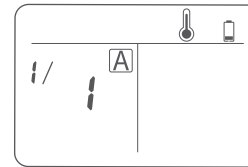

Number of flashes that will activate over-temperature protection:

Power Output Level	Number of Flashes
1/1	35
1/2	60
1/4	120
1/8	196
1/16	285
1/32	465
1/64	820
1/128	1750

Other Protections

Prompts on LCD Panel	Meaning
E0	A failure occurs on the temperature sensor. Please send this kit to a maintenance center.
E1	A failure occurs on the recycling system so that the flash cannot fire. Please restart the flash unit. If the problem still exists, please send this product to a maintenance center.
E2	The system gets excessive heat. Please allow a rest time of 10 minutes.
E3	The voltage on two outlets of the flash tube is too high. Please send this product to a maintenance center.

Technical Data

Product Name	Macro Ring Flash
Model	MF-R76
Guide No.	GN14 /46(ISO 100.in meter/feet)
Compatible Cameras	Canon, Nikon, Sony, Fuji, Olympus, Panasonic, Pentax
Lithium Battery	7.2V/2600mAh
Flash Power (1/1 Power Output)	76Ws
Focus Assist Beam Power	0.7W*2
Focus Assist Beam CCT	5000K
Flash Power Range	1/1-1/128(with 1/3 increment at each stop)
Flash Duration	1/300s~1/20000s
Inner Diameter of Light Body	77mm
Illuminating Distance	3cm~1.5m
Recycle Time	0.1-1.5s
Full Power Flashes	660times
Working Environment Temperature	-10~50°C
Ring Flash Dimension	130*130*27mm/5.1*5.1*1 inches
Controller Dimension	120*70*50mm/4.7*2.7*1.9 inches
Net Weight	≈458g/16.1oz
Net Weight (with battery)	≈577g/20.3 oz

All the above data are based on Godox testing standards. Design and specifications may be subject to change without notice.

Maintenance

- Shut down the device immediately should abnormal operation be detected.
- Avoid sudden impacts and the product should be dedusted regularly.
- It is normal for the flash tube to be warm when in use. Avoid continuous flashes if unnecessary.
- Maintenance of the flash must be performed by our authorized maintenance department which can provide original accessories.
- This product, except consumables e.g. flash tube, is supported with a one-year warranty.
- Unauthorized service will void the warranty.
- If the product had failures or was wetted, do not use it until it is repaired by professionals.
- Changes made to the specifications or designs may not be reflected in this manual.

FCC Statement

This device complies with part 15 of the FCC Rules. Operation is subject to the following two conditions:

- (1) This device may not cause harmful interference, and
- (2) this device must accept any interference received, including interference that may cause undesired operation. Any Changes or modifications not expressly approved by the party responsible for compliance could void the user's authority to operate the equipment.

Note: This equipment has been tested and found to comply with the limits for a Class B digital device, pursuant to part 15 of the FCC Rules. These limits are designed to provide reasonable protection against harmful interference in a residential installation. This equipment generates uses and can radiate radio frequency energy and, if not installed and used in accordance with the instructions, may cause harmful interference to radio communications. However, there is no guarantee that interference will not occur in a particular installation. If this equipment does cause harmful interference to radio or television reception, which can be determined by turning the equipment off and on, the user is encouraged to try to correct the interference

by one or more of the following measures:

- Reorient or relocate the receiving antenna.
- Increase the separation between the equipment and receiver.
- Connect the equipment into an outlet on a circuit different from that to which the receiver is connected.
- Consult the dealer or an experienced radio/TV technician for help.

Declaration of Conformity :

GODOX Photo Equipment Co,Ltd. hereby declares that the Thisequipment are in compliance with the essential requirements and other relevant provisions of EU Directive 2014/30/EU. They are allowed to be used in all EU member states.For more information of DoC, Please click this web link:http://www.godox.com/DOC/Godox_MF-R76_DOC.pdf

产品保修

尊敬的用户，本保修卡是申请保修服务的重要凭证，请您配合销售商填写并妥善保管，谢谢！

产品信息	型号	产品条码
用户信息	姓名	联系电话
	通信地址	
销售商信息	名称	
	联系电话	
	通信地址	
	销售日期	
备注		

注：此表应由销售商盖章确认。

适用产品

本文件适用于相关《产品保修信息》(见后面说明)所列产品，其他非属此范围的产品或部件(如促销品、赠品及其他出厂后附加的部件等)不在此保修承诺内。

保修期

产品及部件的相应保修期按相关的《产品保修信息》执行。保修期自产品首次购买日起算，购买日以购买产品时保修卡登记日期为准。

如何获得保修服务

您可直接与产品销售商或授权服务机构联系，也可拨打神牛产品售后服务电话，与我们联系，由我们的服务人员为您安排服务。申请保修时，您应提供有效的保修卡作为保修凭证，方可获得保修。如您不能提供有效的保修卡，则在我们确认产品或部件属于保修范围的情况下，也可以为您提供保修，但这不作为我们的义务。

不适用保修的情况

如产品存在下列情况，本文件项下的保证和服务将不适用 ①产品或部件超过相应保修期；②错误或不当使用、维护或保管导致的故障或损坏，如：不当搬运；非按产品合理预期用途使用；不当插接外接设备；跌落或外力挤压；接触或暴露于不当温度、溶剂、酸碱、水浸或潮湿环境；③由非神牛授权机构或人员安装、修理、更改、添加或拆卸造成的故障或损坏；④产品或部件原有识别信息被修改变更或删除；⑤无有效保修卡；⑥使用非合法授权、非标准或非公开发行的软件造成的故障或损坏；⑦因不可抗力或意外事件造成的故障或损坏；⑧其他非因产品本身质量问题导致的故障或损坏。遇上述情况，您应向相关责任方寻求解决，神牛对此不承担任何责任。因非在保修期或保修范围内的部件、附件或软件导致产品不能正常使用的，不是保修范围内的故障。产品使用过程中正常的脱色，磨损和消耗，不是保修范围内的故障。

产品保修和服务支持信息

产品的保修期和服务类型按以下《产品保修信息》执行：

产品类别	选件名称	保修期(月)	保修服务类型
部件	电路板	12	客户送修
	电池	3	客户送修
	充电器、电源线，同步线等带电性能的部件。	12	客户送修
其他	如闪光灯管、造型灯泡、外壳、保护罩、锁紧装置、包装等。	无	无保修

神牛产品售后服务电话 0755-29609320-8062

Warranty

Dear customers, as this warranty card is an important certificate to apply for our maintenance service, please fill in the following form in coordination with the seller and safe-keep it. Thank you!

Product Information	Model	Product Code Number
Customer Information	Name	Contact Number
	Address	
Seller Information	Name	
	Contact Number	
	Address	
	Date of Sale	
Note:		

Note: This form shall be sealed by the seller.

Applicable Products

The document applies to the products listed on the Product Maintenance Information (see below for further information). Other products or accessories (e.g. promotional items, giveaways and additional accessories attached, etc.) are not included in this warranty scope.

Warranty Period

The warranty period of products and accessories is implemented according to the relevant Product Maintenance Information. The warranty period is calculated from the day(purchase date) when the product is bought for the first time, And the purchase date is considered as the date registered on the warranty card when buying the product.

How to Get the Maintenance Service

If maintenance service is needed, you can directly contact the product distributor or authorized service institutions. You can also contact the Godox after-sale service call and we will offer you service. When applying for maintenance service, you should provide valid warranty card. If you cannot provide valid warranty card, we may offer you maintenance service once confirmed that the product or accessory is involved in the maintenance scope, but that shall not be considered as our obligation.

Inapplicable Cases

The guarantee and service offered by this document are not applicable in the following cases: ①. The product or accessory has expired its warranty period; ②. Breakage or damage caused by inappropriate usage, maintenance or preservation, such as improper packing, improper usage, improper plugging in/out external equipment, falling off or squeezing by external force, contacting or exposing to the improper temperature, solvent, acid, base, flooding and damp environments, etc; ③. Breakage or damage caused by non-authorized institution or staff in the process of installation, maintenance, alternation, addition and detachment; ④. The original identifying information of product or accessory is modified, alternated, or removed; ⑤. No valid warranty card; ⑥. Breakage or damage caused by using illegally authorized, nonstandard or non-public released software; ⑦. Breakage or damage caused by force majeure or accident; ⑧. Breakage or damage that could not be attributed to the product itself. Once met these situations above, you should seek solutions from the related responsible parties and Godox assumes no responsibility. The damage caused by parts, accessories and software that beyond the warranty period or scope is not included in our maintenance scope. The normal discoloration, abrasion and consumption are not the breakage within the maintenance scope.