

WF-2540 User's Guide

Contents

WF-2540 User's Guide	13
Product Basics	14
Setting Up the Control Panel	14
Control Panel Buttons and Lights	14
Changing LCD Screen Language.....	15
Turning Off Control Panel Sounds.....	16
Product Parts Locations	17
Product Parts - Top and Front	18
Product Parts - Inside	21
Product Parts - Back.....	22
Scanning, Copying, and Faxing from the Control Panel	22
The Sleep Timer.....	23
Changing the Sleep Timer Setting From the Control Panel	23
Changing the Sleep Timer Setting - Windows	24
Changing the Sleep Timer Setting - Mac OS X.....	25
Epson Connect Solutions for Smartphones, Tablets, and More	26
Using Epson Email Print	27
Using the Epson iPrint Mobile App	27
Using Epson Remote Print	27
Using Epson Scan to Cloud.....	28
Using AirPrint	28
Using Google Cloud Print	29
Selecting Wireless Network Settings From the Control Panel	30
Loading Paper	32
Loading Paper for Documents	32
Loading Paper for Photos	35
Loading Envelopes	38
Paper Loading Capacity	41
Available EPSON Papers.....	42
Borderless Paper Type Compatibility	43

Paper or Media Type Settings	44
Placing Originals on the Product	46
Placing Originals on the Scanner Glass	46
Placing Originals in the Automatic Document Feeder	47
Copying	51
Copying Documents or Photos	51
Paper Type Settings - Copying	52
Paper Size Settings - Copying	53
Copying Options	54
Copying ID Cards	54
Printing From a Computer	57
Printing with Windows	57
Selecting Basic Print Settings - Windows	57
Print Quality Options - Windows	60
Multi-Page Printing Options - Windows	60
Selecting Double-sided Printing Settings - Windows	60
Double-sided Printing Options - Windows	62
Selecting Additional Layout and Print Options - Windows	62
Custom Color Correction Options - Windows	64
Image Options and Additional Settings - Windows	65
Header/Footer Settings - Windows	66
Selecting a Printing Preset - Windows	66
Printing Your Document or Photo - Windows	67
Selecting Default Print Settings - Windows	68
Changing the Language of the Printer Software Screens	69
Changing Automatic Update Options	70
Printing with Mac OS X	71
Selecting Basic Print Settings - Mac OS X	72
Print Quality Options - Mac OS X	75
Print Options - Mac OS X	75
Selecting Page Setup Settings - Mac OS X	76
Selecting Print Layout Options - Mac OS X	77
Managing Color - Mac OS X	78

Color Matching and Color Options - Mac OS X	79
Selecting Printing Preferences - Mac OS X	79
Printing Preferences - Mac OS X	80
Printing Your Document or Photo - Mac OS X	81
Checking Print Status - Mac OS X	81
Cancelling Printing Using a Product Button.....	82
Scanning	83
Starting a Scan.....	83
Starting a Scan Using the Product Control Panel	83
Scan to USB Device Options	85
Changing Default Scan Button Settings.....	86
Starting a Scan Using the Epson Scan Icon	86
Starting a Scan from a Scanning Program.....	89
Selecting Epson Scan Settings	91
Scan Modes.....	91
Selecting the Scan Mode.....	91
Scanning in Office Mode.....	92
Available Document Source Settings - Office Mode.....	94
Selecting a Scan Area - Office Mode	95
Available Image Adjustments - Office Mode	96
Scanning in Home Mode	97
Selecting a Scan Area - Home Mode	100
Available Image Adjustments - Home Mode	103
Selecting a Scan Size - Home Mode.....	104
Scanning in Professional Mode	106
Available Document Source Settings - Professional Mode	109
Available Image Types - Professional Mode	109
Selecting a Scan Area - Professional Mode	109
Available Image Adjustments - Professional Mode	112
Selecting a Scan Size - Professional Mode.....	114
Image Preview Guidelines.....	117
Scan Resolution Guidelines	117
Selecting Scan File Settings.....	118

Available Scanned File Types and Optional Settings.....	119
Scanning with Mac OS X 10.6/10.7/10.8 Using Image Capture	120
Available Scan Settings - Mac OS X Image Capture	122
Scanning Special Projects.....	122
Scanning to a PDF File.....	122
Restoring Photo Colors as You Scan	125
Convert Scanned Documents to Editable Text (OCR).....	126
Scanning Using OCR - Windows	126
Scanning Using OCR - Mac OS X.....	128
Faxing.....	131
Connecting a Telephone or Answering Machine.....	131
Setting Up Fax Features	138
Setting Up Fax Features Using the Product Control Panel	138
Selecting Your Country or Region.....	138
Selecting the Date and Time.....	139
Entering Fax Header Information	141
Entering Numbers and Characters for Faxing.....	142
Selecting Fax Send and Receive Settings	143
Selecting Fax Communication Settings	144
Printing Fax Reports	145
Restoring Default Fax Settings	146
Fax Sending Options	147
Fax Receive Options.....	148
Fax Communications Options.....	148
Fax Report Options.....	150
Restore Default Settings Options.....	150
Setting Up Fax Features Using the Fax Utility - Windows.....	150
Setting Up Fax Features Using the Fax Utility - Mac OS X	152
Setting Up Speed Dial and Group Dial Lists.....	153
Setting Up Speed/Group Dial Lists Using the Product Control Panel	153
Creating Speed Dial List Entries	154
Printing Your Speed Dial List	156
Creating Group Dial List Entries.....	157

Printing Your Group Dial List.....	159
Setting Up Speed/Group Dial Lists Using the Fax Utility - Windows.....	161
Setting Up Speed/Group Dial Lists Using the Fax Utility - Mac OS X.....	164
Sending Faxes.....	165
Sending Faxes from the Product Control Panel.....	166
Manually Dialing or Redialing Fax Numbers.....	166
Selecting Fax Numbers From Speed or Group Dial Lists.....	167
Dialing Fax Numbers from a Connected Telephone.....	168
Broadcasting a Fax.....	169
Sending a Fax at a Specified Time.....	171
Fax Send Options.....	172
Sending Faxes Using the Fax Utility - Windows.....	172
Sending Faxes Using the Fax Utility - Mac OS X.....	174
Receiving Faxes.....	177
Fax Reception.....	177
Receiving Faxes Automatically (Auto Answer).....	178
Receiving Faxes Manually.....	178
Using USB Flash Drives With Your Product.....	180
Inserting a USB Flash Drive.....	180
Removing a USB Flash Drive.....	180
Transferring Files on a USB Flash Drive.....	180
Setting Up File Sharing for File Transfers From Your Computer.....	181
Transferring Files from a USB Flash Drive to Your Computer.....	181
Replacing Ink Cartridges.....	183
Check Cartridge Status.....	183
Checking Cartridge Status on the LCD Screen.....	183
Checking Cartridge Status with Windows.....	184
Checking Cartridge Status with Mac OS X.....	187
Purchase Epson Ink Cartridges.....	189
Ink Cartridge Part Numbers.....	189
Removing and Installing Ink Cartridges.....	190
Replacing Ink Cartridges Using a Computer Utility.....	196
Printing With Black Ink and Expended Color Cartridges.....	197

Printing With Expended Color Cartridges - Windows.....	198
Printing With Expended Color Cartridges - Mac OS X.....	198
Conserving Low Black Ink with Windows	200
Adjusting Print Quality.....	201
Print Head Maintenance.....	201
Print Head Nozzle Check.....	201
Checking the Nozzles Using the Product Control Panel	201
Checking the Nozzles Using a Computer Utility	204
Print Head Cleaning	207
Cleaning the Print Head Using the Product Control Panel	207
Cleaning the Print Head Using a Computer Utility.....	209
Print Head Alignment.....	212
Aligning the Print Head Using the Product Control Panel.....	212
Aligning the Print Head Using a Computer Utility	214
Cleaning the Paper Path	215
Cleaning and Transporting Your Product	217
Cleaning Your Product	217
Transporting Your Product	219
Solving Problems	221
Checking for Software Updates.....	221
Product Status Messages	222
Running a Product Check	223
Resetting Control Panel Defaults	224
Solving Setup Problems	225
Noise After Ink Installation.....	226
Software Installation Problems	226
Control Panel Setup Problems	227
Solving Network Problems	227
Product Cannot Connect to a Wireless Router or Access Point	227
Network Software Cannot Find Product on a Network.....	228
Product Does Not Appear in Mac OS X Printer Window	228
Cannot Print Over a Network.....	228
Cannot Scan Over a Network	229

Printing a Network Status Sheet.....	230
Solving Copying Problems	231
Product Makes Noise, But Nothing Copies.....	231
Product Makes Noise When It Sits for a While.....	231
Solving Paper Problems.....	231
Paper Feeding Problems.....	232
Paper Jam Problems	232
Document Jams in the Automatic Document Feeder	235
Paper Ejection Problems	239
Solving Problems Printing from a Computer.....	239
Nothing Prints	240
Product Icon Does Not Appear in Windows Taskbar	241
Error After Cartridge Replacement	241
Printing is Slow	242
Solving Page Layout and Content Problems	243
Inverted Image.....	243
Too Many Copies Print	243
Blank Pages Print	244
Incorrect Margins on Printout.....	244
Border Appears on Borderless Prints	245
Incorrect Characters Print.....	245
Incorrect Image Size or Position	246
Slanted Printout	247
Solving Print Quality Problems.....	247
White or Dark Lines in Printout	247
Blurry or Smearred Printout	248
Faint Printout or Printout Has Gaps	249
Grainy Printout.....	250
Incorrect Colors	251
Solving Scanning Problems	252
Scanning Software Does Not Operate Correctly	252
Cannot Start Epson Scan	252
Solving Scanned Image Quality Problems	253

Image Consists of a Few Dots Only	254
Line of Dots Appears in All Scanned Images	254
Straight Lines in an Image Appear Crooked	255
Image is Distorted or Blurry	255
Image Colors are Patchy at the Edges	255
Image is Too Dark	255
Back of Original Image Appears in Scanned Image	256
Ripple Patterns Appear in an Image	256
Image is Scanned Upside-Down	256
Scanned Image Colors Do Not Match Original Colors	256
Scan Area is Not Adjustable in Thumbnail Preview	257
Scanned Image Edges are Cropped	257
Solving Faxing Problems.....	257
Cannot Send or Receive Faxes	258
Cannot Receive Faxes with a Telephone Connected to Your Product	259
Cannot Transfer Files To or From a USB Flash Drive	259
When to Uninstall Your Product Software	260
Uninstalling Product Software - Windows	260
Uninstalling Product Software - Mac OS X	261
Where to Get Help.....	262
Technical Specifications	263
Windows System Requirements	263
Mac System Requirements	264
Printing Specifications	264
Scanning Specifications	264
Automatic Document Feeder (ADF) Specifications	265
Fax Specifications	265
Paper Specifications	266
Printable Area Specifications	267
Ink Cartridge Specifications.....	269
Dimension Specifications	270
Electrical Specifications	270
Environmental Specifications	271

Interface Specifications	271
External USB Device Specifications.....	271
Network Interface Specifications	271
Safety and Approvals Specifications	272
Notices	273
FCC Compliance Statement.....	273
Software Notices	276
Trademarks	279
Copyright Notice.....	280
libTIFF Software Acknowledgment.....	280
A Note Concerning Responsible Use of Copyrighted Materials.....	281
Default Delay Times for Power Management for Epson Products	281
Copyright Attribution	281

WF-2540 User's Guide

Welcome to the *WF-2540 User's Guide*.

Product Basics

See these sections to learn about the basic features of your product.

[Setting Up the Control Panel](#)

[Product Parts Locations](#)

[Scanning, Copying, and Faxing from the Control Panel](#)

[The Sleep Timer](#)

[Epson Connect Solutions for Smartphones, Tablets, and More](#)

Setting Up the Control Panel

See these sections to set up the control panel for use.

[Control Panel Buttons and Lights](#)

[Changing LCD Screen Language](#)







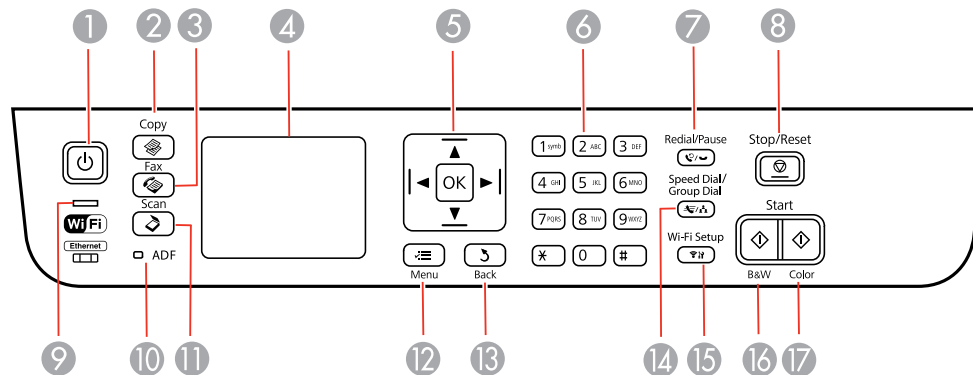

[Turning Off Control Panel Sounds](#)

Parent topic: [Product Basics](#)

Control Panel Buttons and Lights



- 1 The power button and the power light
- 2 The **Copy** button

- 3 The  **Fax** button
- 4 The LCD screen
- 5 The arrow buttons and the **OK** button
- 6 The number pad
- 7 The  **Redial/Pause** button
- 8 The  **Stop/Reset** button
- 9 The WiFi light
- 10 The **ADF** light
- 11 The  **Scan** button
- 12 The  **Menu** button
- 13 The  **Back** button
- 14 The  **Speed Dial/Group Dial** button
- 15 The  **Wi-Fi Setup** button
- 16 The  **Start B&W** button
- 17 The  **Start Color** button

Parent topic: [Setting Up the Control Panel](#)

Changing LCD Screen Language

You can change the language used on the LCD screen.

1. Press the  **Menu** button.
2. Press the up or down arrow buttons to select **Printer Setup** and press the **OK** button.

You see this screen:



3. Press the up or down arrow buttons to select **Language** and press the **OK** button.
4. Press the up or down arrow buttons to select a language and press the **OK** button.
5. Press the  **Menu** button to exit.

Parent topic: [Setting Up the Control Panel](#)

Turning Off Control Panel Sounds

You can turn off the sound heard when you press buttons on the control panel.

1. Press the  **Menu** button.
2. Press the up or down arrow buttons to select **Printer Setup** and press the **OK** button.

You see this screen:



3. Press the up or down arrow buttons to select **Sound** and press the **OK** button.
4. Press the up or down arrow buttons to select the **Off** setting and press the **OK** button.
5. Press the  **Menu** button to exit.

Parent topic: [Setting Up the Control Panel](#)

Product Parts Locations

See these sections to identify the parts on your product.

[Product Parts - Top and Front](#)

[Product Parts - Inside](#)

[Product Parts - Back](#)

Parent topic: [Product Basics](#)

Product Parts - Top and Front

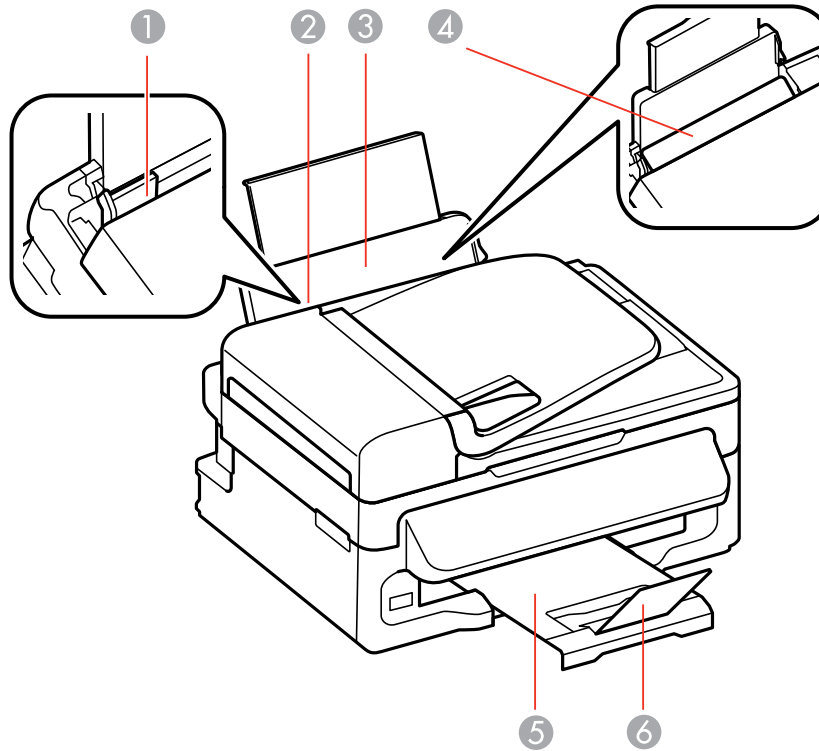

- 1 Edge guide
- 2 Sheet feeder
- 3 Paper support
- 4 Feeder guard
- 5 Output tray
- 6 Paper stopper

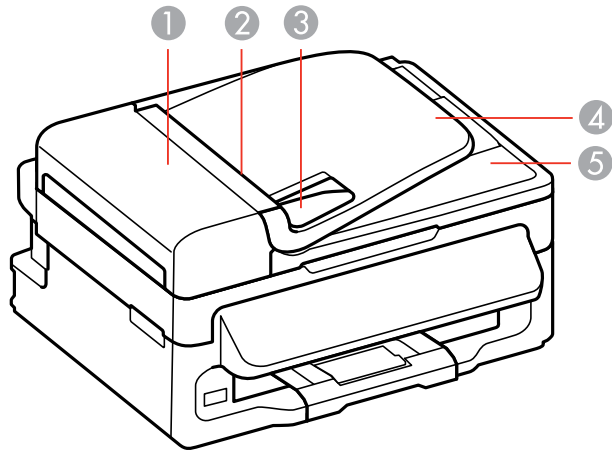

- 1 ADF cover
- 2 Automatic Document Feeder (ADF)
- 3 ADF edge guide
- 4 ADF input tray
- 5 ADF output tray

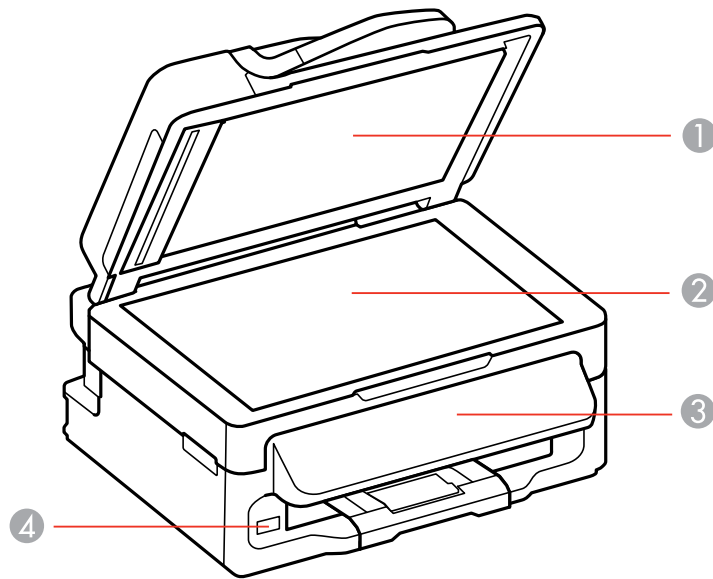

- 1 Document cover
- 2 Scanner glass
- 3 Control panel
- 4 USB port for external devices

Parent topic: [Product Parts Locations](#)

Product Parts - Inside

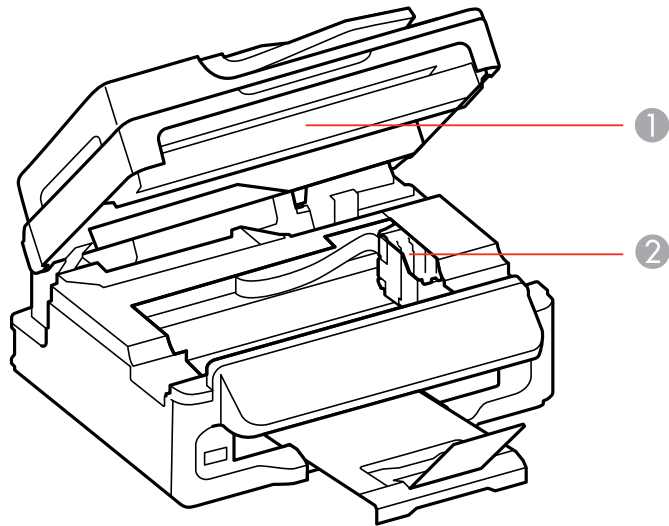

- 1 Scanner unit
- 2 Ink cartridge holder in home position

Parent topic: [Product Parts Locations](#)

Product Parts - Back

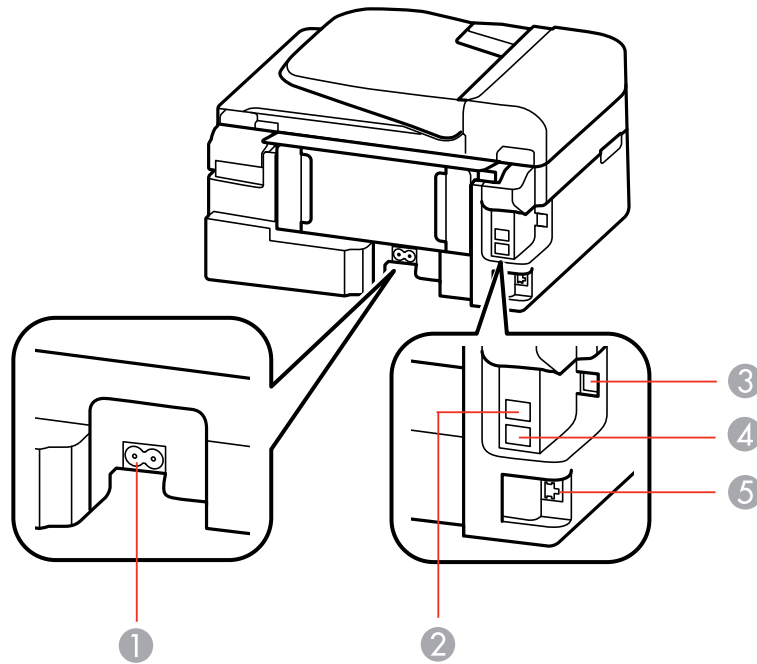

- 1 AC inlet
- 2 **LINE** port
- 3 **USB** port
- 4 **EXT** port
- 5 **LAN** port

Parent topic: [Product Parts Locations](#)

Scanning, Copying, and Faxing from the Control Panel

You can scan, copy, and fax right from your product control panel.

- Use the control panel to quickly scan a photo or document and save it on your computer or on a USB flash drive. You can even scan and send the file to an online service or to a remote printer.

- Your product works like a copy machine too. You can place a photo or document on the scanner glass, or load pages in the automatic document feeder (ADF).
- For faxing, you first need to connect a phone line as described on the *Start Here* sheet. Then load your document and use the control panel to enter a phone number or select a number from your speed dial list.

Parent topic: [Product Basics](#)

Related tasks

[Starting a Scan Using the Product Control Panel](#)

Related topics

[Copying](#)

[Faxing](#)

The Sleep Timer

The product enters sleep mode if it is not used for a period of time. You can adjust the time period before sleep mode, but increasing the time reduces the product's energy efficiency.

[Changing the Sleep Timer Setting From the Control Panel](#)

[Changing the Sleep Timer Setting - Windows](#)

[Changing the Sleep Timer Setting - Mac OS X](#)

Parent topic: [Product Basics](#)

Changing the Sleep Timer Setting From the Control Panel

You can use the product's control panel to change the time period before the product enters sleep mode.

1. Press the  **Menu** button.
2. Press the up or down arrow buttons to select **Printer Setup** and press the **OK** button.

You see this screen:



3. Press the up or down arrow buttons to select **Sleep Timer** and press the **OK** button.
You see this screen:

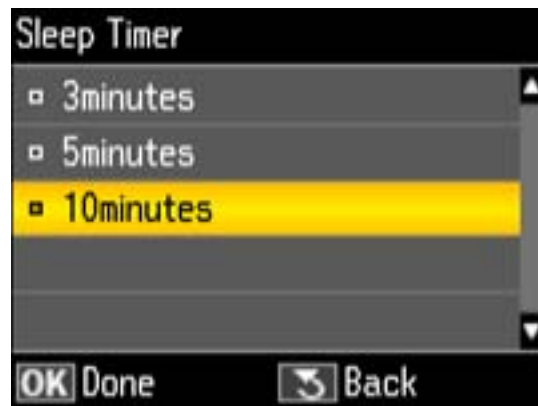

4. Press the up or down arrow buttons to select the time period you want, then press the **OK** button.
5. Press the  **Menu** to exit.

Parent topic: [The Sleep Timer](#)

Changing the Sleep Timer Setting - Windows

You can use the printer software to change the time period before the product enters sleep mode.

1. Right-click the product icon in the Windows taskbar and select **Printer Settings**.
2. Click the **Maintenance** tab and select **Printer and Option Information**.

You see this window:

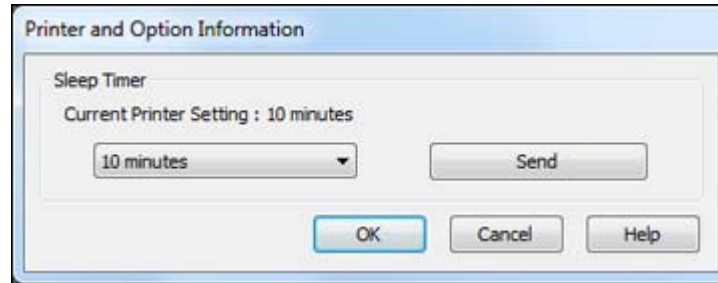

3. Select the time period you want as the Sleep Timer setting.
4. Click **Send**.
5. When you see the time period you selected listed as the Current Printer Setting, click **OK**.

Parent topic: [The Sleep Timer](#)

Changing the Sleep Timer Setting - Mac OS X

You can use the printer software to change the time period before the product enters sleep mode.

1. Do one of the following:
 - **Mac OS X 10.6/10.7/10.8:** In the Apple menu or the Dock, select **System Preferences**. Select **Print & Fax** or **Print & Scan**, select your product, and select **Options & Supplies**. Select **Utility** and select **Open Printer Utility**.
 - **Mac OS X 10.5:** In the Apple menu or the Dock, select **System Preferences**. Select **Print & Fax**, select your product, and select **Open Print Queue**. Select **Utility**.
2. Click **Printer Settings**.

You see this window:

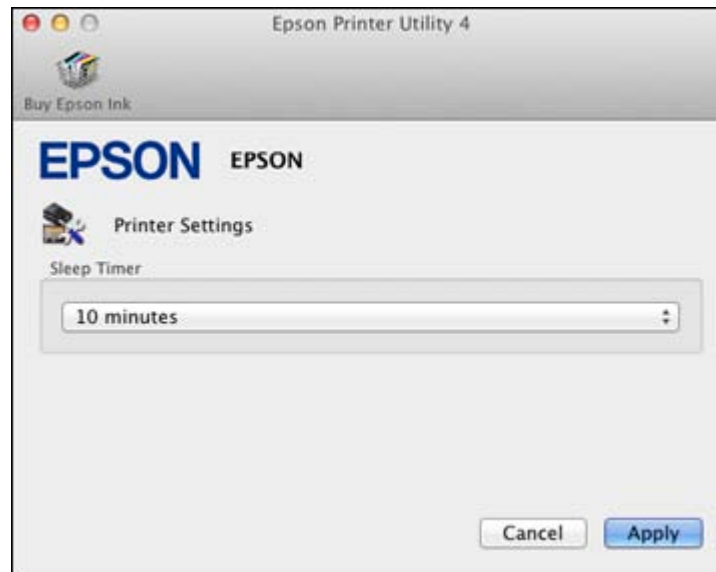

3. Select the time period you want as the Sleep Timer setting.
4. Click **Apply**.
5. Close the Printer Settings window.

Parent topic: [The Sleep Timer](#)

Epson Connect Solutions for Smartphones, Tablets, and More

You can print documents, photos, emails, and web pages from your home, office, or even across the globe. You can use your smartphone, tablet, or computer. Epson offers these solutions to print and scan from anywhere: Epson Email Print, Epson iPrint Mobile App, Epson Remote Print, and Epson Scan to Cloud.

[Using Epson Email Print](#)

[Using the Epson iPrint Mobile App](#)

[Using Epson Remote Print](#)

[Using Epson Scan to Cloud](#)

[Using AirPrint](#)

[Using Google Cloud Print](#)

Parent topic: [Product Basics](#)

Using Epson Email Print

With Epson Email Print, you can print from any device that can send email, such as your smartphone, tablet, or laptop. Just activate your product's unique email address. When you want to print, attach a PDF, Microsoft Office document, or photo and send an email to your product.

1. Set up your product for network printing as described on the *Start Here* sheet.
2. If you did not already set up Email Print when you installed your product software, visit www.epson.com/connect to learn more about Email Print, check compatibility, and get detailed setup instructions.
3. Send an email with attachments to your product's Email Print address.

Note: Both the email and any attachments print by default. You can change these printing options by logging into your Epson Connect account.

Parent topic: [Epson Connect Solutions for Smartphones, Tablets, and More](#)

Using the Epson iPrint Mobile App

Use this free Apple and Android app to print to nearby Epson networked products. The Epson iPrint Mobile App lets you print PDFs, Microsoft Office documents, photos, and web pages over a wireless network. You can even scan and save a file on your device, send it as an email, or upload it to an online service such as Box, Dropbox, EverNote, or Google Docs.

1. Set up your product for network printing as described on the *Start Here* sheet.
2. Visit www.epson.com/connect to learn more about Epson iPrint and check the compatibility of your mobile device.
3. Download Epson iPrint from the Apple App Store or Google Play.
4. Connect your mobile device to the same wireless network that your product is using.
5. Print from your mobile device to your Epson product.

Parent topic: [Epson Connect Solutions for Smartphones, Tablets, and More](#)

Using Epson Remote Print

With Epson Remote Print software on your Windows computer or laptop, you can print to an Epson Email-enabled product anywhere in the world.

1. Visit www.epson.com/connect to learn more about Remote Print and how to download the software.
2. Download and install the Remote Print software.

3. Obtain the email address and optional access key of the Epson product you want to use for printing, and enter this address during Remote Print setup.
4. Select the print command in your application and choose the Remote Print driver for your Epson product.

Parent topic: [Epson Connect Solutions for Smartphones, Tablets, and More](#)

Using Epson Scan to Cloud

The Epson Scan to Cloud service sends your scanned files to a destination that you have registered with Epson Connect.

1. Set up your product for network printing as described on the *Start Here* sheet.
2. Visit www.epson.com/connect for instructions on registering an account and your product with Epson Connect.
3. After registering, sign in to the Epson Connect web page with the email address and password you selected.
4. Select **Destination List** for Scan to Cloud.
5. Click **Add**, then follow the instructions on the screen to create your destination list.
6. When you're ready to scan, select the setting for the Scan to Cloud service on your product control panel.

Parent topic: [Epson Connect Solutions for Smartphones, Tablets, and More](#)

Related tasks

[Starting a Scan Using the Product Control Panel](#)

Using AirPrint

AirPrint allows you to wirelessly print to your AirPrint-enabled product from iPhone, iPad, and iPod touch running the latest version of iOS.

1. Set up your product for wireless printing as described on the *Start Here* sheet.
2. Connect your Apple device to the same wireless network that your product is using.
3. Print from your iPad, iPhone, or iPod touch to your product.

Parent topic: [Epson Connect Solutions for Smartphones, Tablets, and More](#)

Using Google Cloud Print

With a Google Account, you can print from your Apple or Android device to your Epson wireless product. You can also print from Chromebooks and the Google Chrome browser without drivers or cables.

If you are setting up your product for the first time, set up your Epson product for wireless printing as described on the *Start Here* sheet.

Note: Make sure your Epson printer and computer are connected to the same network before starting the Google Cloud Print setup.

If your product is already on your wireless network, follow these steps:

1. Connect your device to the same wireless network that your Epson product is using.
2. Print a network status sheet.
3. Locate your product's IP address on the network status sheet.
4. Enter the IP address into the address bar of a web browser.
5. Select the **Google Cloud Print Services** option.

Note: If you don't see the **Google Cloud Print Services** option, turn your product off and back on. If the option still doesn't appear, select the **Firmware Update** option and follow the on-screen instructions to update your product.

6. Click **Register**.
7. Select the check box to agree to the Usage Advisory and click **Next**.
8. Click **OK** to launch the sign-in page.
A separate browser window opens.
9. Enter your Google Account username and password and click **Sign in**, or, if you don't have an account, click **Sign up for a new Google Account** and follow the on-screen instructions.
10. Click **Finish printer registration** to complete setup and print a test page.
Your product is now linked to your Google Account and can be accessed from any Chromebook, computer, Apple or Android device with internet access. Visit [Epson Support](#) for more information on using Google Cloud Print, or the [Google Cloud Print](#) website for a list of [supported apps](#).

Parent topic: [Epson Connect Solutions for Smartphones, Tablets, and More](#)

Related tasks

[Printing a Network Status Sheet](#)

Selecting Wireless Network Settings From the Control Panel

You can select or change wireless network settings using your product control panel.

To install your product on a wireless network, follow the instructions on the *Start Here* sheet and install the necessary software from the product CD. The installer program guides you through network setup.

1. Press the  **Wi-Fi Setup** button.

You see this screen:



2. Press the **OK** button to select **Wi-Fi Setup Wizard**.
3. Press the up or down arrow buttons to select the name of your wireless network and press the **OK** button. If you do not see your wireless network's name, you can enter it manually.

Note: To enter the wireless network name manually, select **Other SSIDs** and press the **OK** button. Enter your network name as described in the next step.

4. Enter your wireless password (or network name and then password).



- Press the arrow buttons to highlight a character or a function button displayed on the keypad. Then press the **OK** button to select it.
 - To change the case of letters, select **AB12** (uppercase), **ab12** (lowercase) and press the **OK** button.
 - To select a symbol, select **Symbol** and press the **OK** button. Then highlight a symbol and press the **OK** button to select it.
 - To enter a space, select **Space** and press the **OK** button.
 - To delete characters, select the back arrow and press the **OK** button.
 - When you finish entering characters, select **Done** and press the **OK** button.
5. Press the **OK** button to confirm Wi-Fi settings.
 6. Select **Yes** if you want to print a network status report, or **No** if not, and press the **OK** button. The WiFi light should now be on, but not flashing.

Note: If the WiFi light is off, you may have selected the wrong network name or entered the password incorrectly. Repeat these steps to try again.

Related topics

[Solving Network Problems](#)

Loading Paper

Before you print, load paper for the type of printing you will do.

[Loading Paper for Documents](#)

[Loading Paper for Photos](#)

[Loading Envelopes](#)

[Paper Loading Capacity](#)

[Available EPSON Papers](#)

[Borderless Paper Type Compatibility](#)

[Paper or Media Type Settings](#)

Loading Paper for Documents

You can print documents on a variety of paper types and sizes.

1. Flip the feeder guard forward.

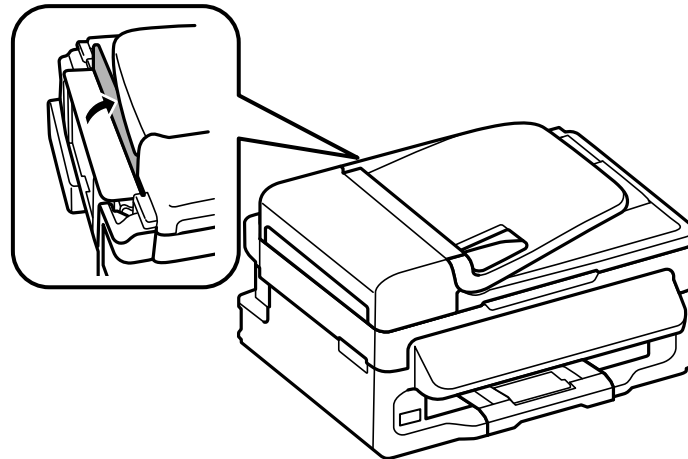

2. Raise the paper support and its extension, pull out the output tray, then raise the paper stopper.

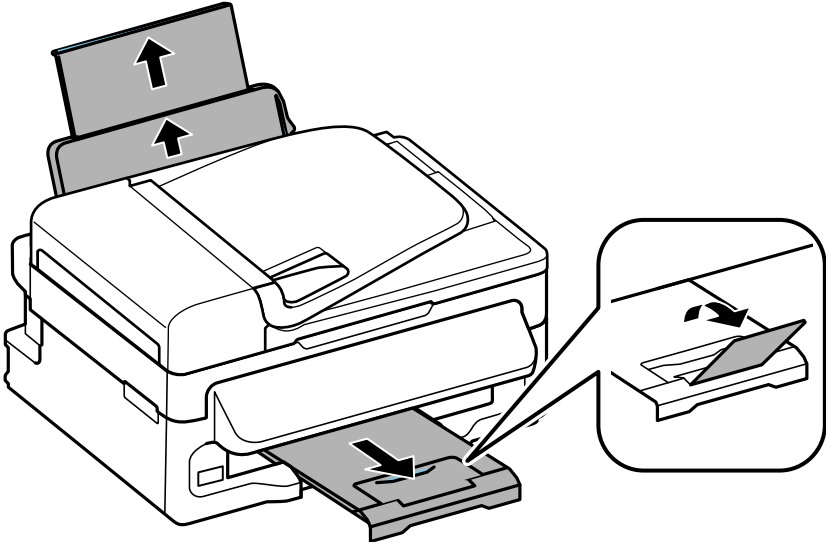

3. Slide the edge guide to the left.

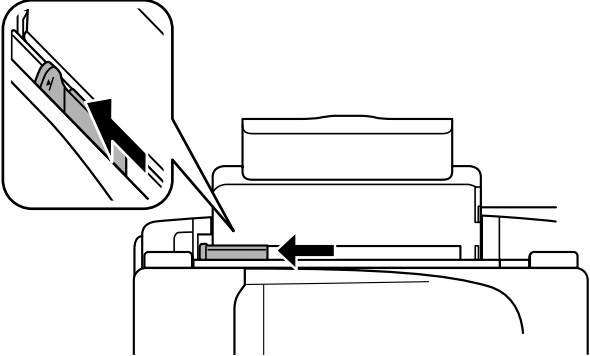

4. Insert paper, glossy or printable side up and short edge first, against the right side. If you are inserting a stack of paper, fan the sheets first and tap the stack on a flat surface to even the edges.

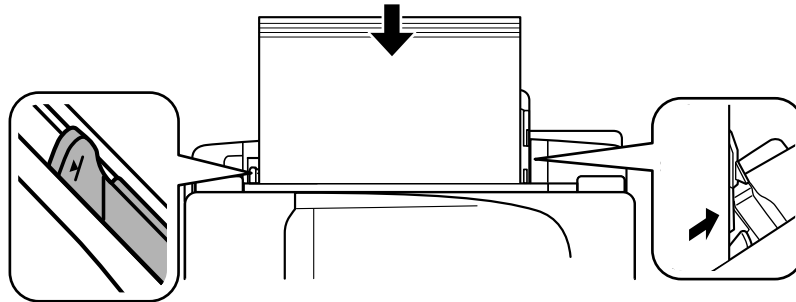

5. Slide the edge guide against the paper, but not too tightly.

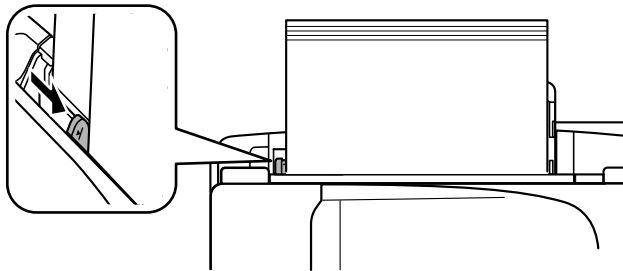

6. Flip the feeder guard back.

Always follow these paper loading guidelines:

- Load only the recommended number of sheets.
- Load paper short edge first, no matter which way your document faces.
- Load letterhead or pre-printed paper top edge first.
- Do not load paper above the arrow mark inside the edge guide.
- Check the paper package for any additional loading instructions.
- If you use paper with binder holes, load only one sheet at a time and use only these sizes: Letter (8.5 x 11 inches [216 x 279 mm]), A4 (8.3 x 11.7 inches [210 x 297 mm]), or Legal (8.5 x 14 inches [216 x 357 mm]).

Parent topic: [Loading Paper](#)

Related references

[Paper Loading Capacity](#)

Loading Paper for Photos

You can print photos on a variety of paper types and sizes.

1. Flip the feeder guard forward.

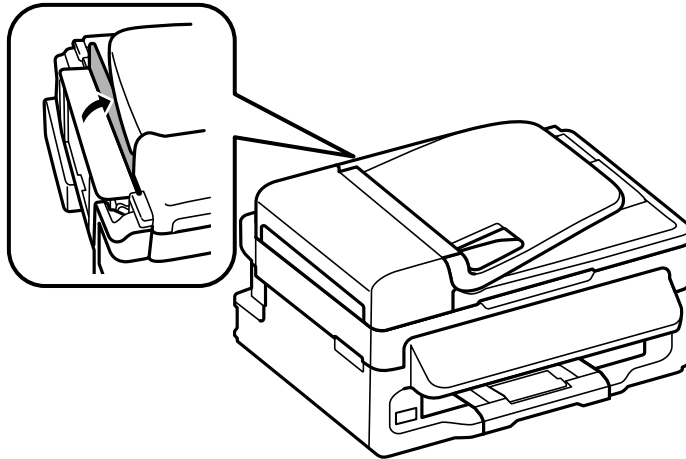

2. Raise the paper support and its extension, pull out the output tray, then raise the paper stopper.

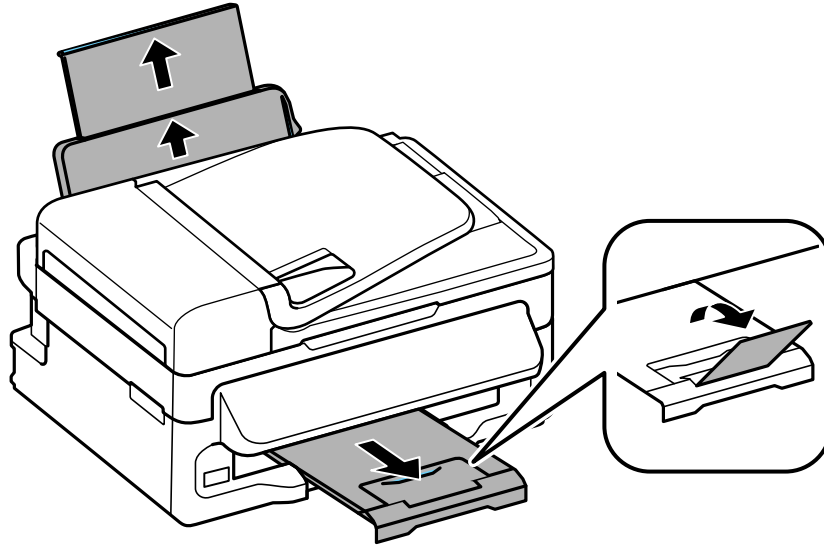

3. Slide the edge guide to the left.

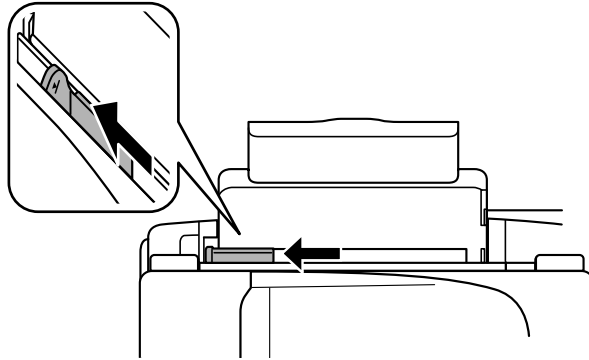

4. Insert paper, glossy or printable side up and short edge first, against the right side. If you are inserting a stack of paper, fan the sheets first and tap the stack on a flat surface to even the edges.

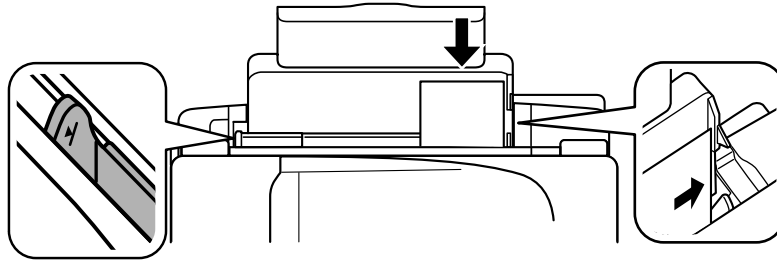

5. Slide the edge guide against the paper, but not too tightly.

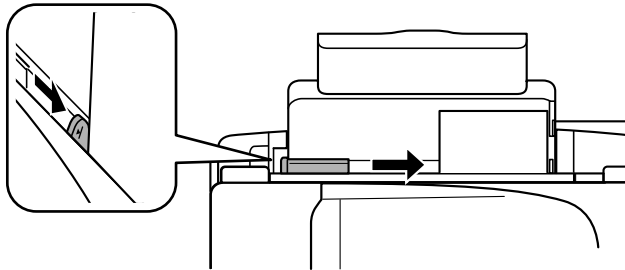

6. Flip the feeder guard back.

Always follow these paper loading guidelines:

- Load only the recommended number of sheets.
- Load paper short edge first, no matter which way your photo faces.
- Do not load paper above the arrow mark inside the edge guide.
- Check the paper package for any additional loading instructions.

Parent topic: [Loading Paper](#)

Related references

[Paper Loading Capacity](#)

Loading Envelopes

You can print on plain paper envelopes in this size: No. 10 (4.1 × 9.5 inches [105 × 241 mm]).

1. Flip the feeder guard forward.

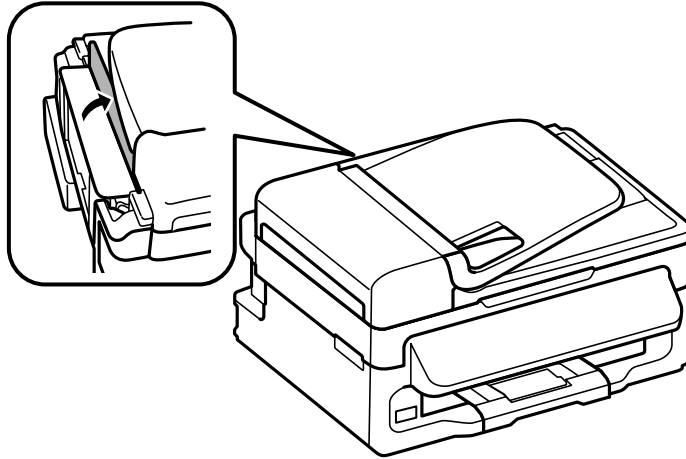

2. Raise the paper support and its extension, pull out the output tray, then raise the paper stopper.

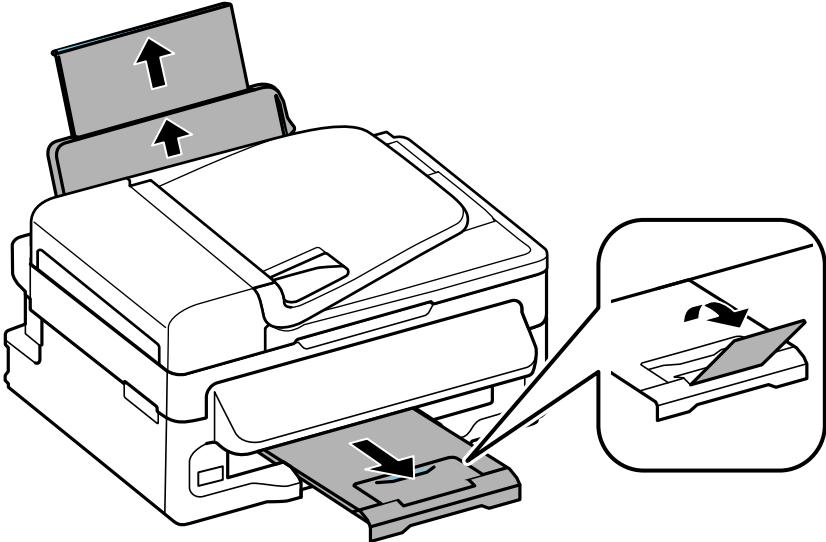

3. Slide the edge guide to the left.

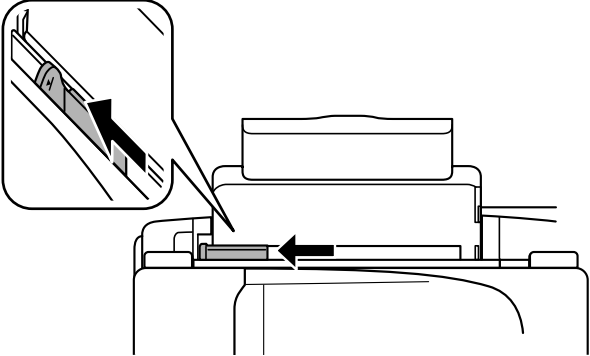

4. Load up to 10 envelopes against the right side. Load them printable side up and flap edge left.

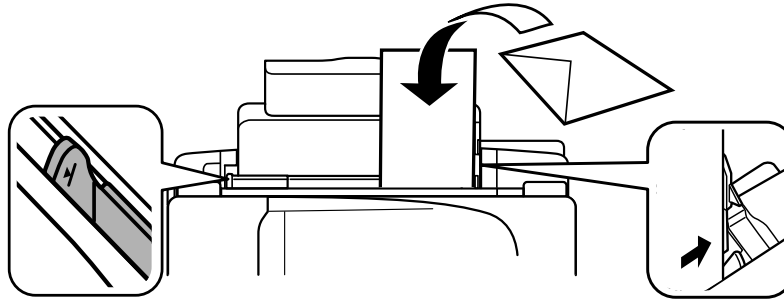

5. Slide the edge guide against the envelopes, but not too tightly.

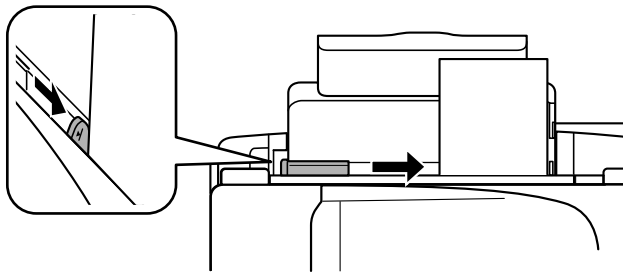

6. Flip the feeder guard back.

Always follow these loading guidelines:

- If you have trouble loading a stack of envelopes, press each envelope flat before loading it or load one envelope at a time.
- Do not load envelopes above the arrow mark inside the edge guide.
- Do not load envelopes that are curled, folded, or too thin, or that have plastic windows.

Parent topic: [Loading Paper](#)

Paper Loading Capacity

Paper type	Loading capacity
Plain paper - Letter (8.5 × 11 inches [216 × 279 mm]) or A4 (8.3 × 11.7 inches [210 × 297 mm]) **	Approximately 100 sheets *
Epson Bright White Paper ** Epson Presentation Paper Matte - Letter (8.5 × 11 inches [216 × 279 mm])	80 sheets
Epson Photo Paper Glossy Epson Premium Photo Paper Glossy Epson Premium Photo Paper Semi-gloss	20 sheets
Plain paper - Legal (8.5 × 14 inches [216 × 357 mm]) Epson Presentation Paper Matte - Legal (8.5 × 14 inches [216 × 357 mm]) Epson Premium Presentation Paper Matte Epson Premium Presentation Paper Matte Double-sided Epson Ultra Premium Presentation Paper Matte Epson Brochure & Flyer Paper Matte Double-sided Epson Ultra Premium Photo Paper Glossy Epson Photo Quality Self-adhesive Sheets Epson Iron-on Cool Peel Transfer paper User defined paper size of any type Any type of paper with binder holes	1 sheet
Envelopes	10 envelopes

* Based on 20 lb (75 g/m²) paper weight. Do not load paper above the arrow mark inside the edge guide.

** For two-sided printing, load up to 30 sheets.

Parent topic: [Loading Paper](#)

Available EPSON Papers

You can purchase genuine Epson ink and paper at Epson Supplies Central at www.epson.com/ink3 (U.S. sales) or www.epson.ca (Canadian sales). You can also purchase supplies from an Epson authorized reseller. To find the nearest one, call 800-GO-EPSON (800-463-7766).

Paper Type	Size	Part number	Sheet count
Epson Bright White Paper	Letter (8.5 × 11 inches [216 × 279 mm])	S041586	500
Epson Brochure & Flyer Paper Matte Double-sided	Letter (8.5 × 11 inches [216 × 279 mm])	S042384	150
Epson Ultra Premium Presentation Paper Matte	Letter (8.5 × 11 inches [216 × 279 mm])	S041341	50
Epson Premium Presentation Paper Matte	8 × 10 inches (203 × 254 mm)	S041467	50
	Letter (8.5 × 11 inches [216 × 279 mm])	S041257 S042180	50 100
Epson Premium Presentation Paper Matte Double-sided	Letter (8.5 × 11 inches [216 × 279 mm])	S041568	50
Epson Presentation Paper Matte	Letter (8.5 × 11 inches [216 × 279 mm])	S041062	100
	Legal (8.5 × 14 inches [216 × 357 mm])	S041067	100
Epson Ultra Premium Photo Paper Glossy	4 × 6 inches (102 × 152 mm)	S042181 S042174	60 100
	5 × 7 inches (127 × 178 mm)	S041945	20
	8 × 10 inches (203 × 254 mm)	S041946	20
	Letter (8.5 × 11 inches [216 × 279 mm])	S042182	25
		S042175	50
Epson Premium Photo Paper Semi-gloss	4 × 6 inches (102 × 152 mm)	S041982	40
	Letter (8.5 × 11 inches [216 × 279 mm])	S041331	20

Paper Type	Size	Part number	Sheet count
Epson Premium Photo Paper Glossy	4 x 6 inches (102 x 152 mm)	S041808	40
		S041727	100
	5 x 7 inches (127 x 178 mm)	S041464	20
	8 x 10 inches (203 x 254 mm)	S041465	20
Epson Photo Paper Glossy	4 x 6 inches (102 x 152 mm)	S041809	50
		S042038	100
	Letter (8.5 x 11 inches [216 x 279 mm])	S041141	20
Epson Photo Quality Self-adhesive Sheets	A4 (8.3 x 11.7 inches [210 x 297 mm])	S041106	10
		S041153	10
Epson Iron-on Cool Peel Transfer paper	Letter (8.5 x 11 inches [216 x 279 mm])	S041153	10

Parent topic: [Loading Paper](#)

Borderless Paper Type Compatibility

You can print borderless photos on compatible paper types in compatible sizes:

Borderless Paper Types

- Epson Premium Presentation Paper Matte
- Epson Premium Presentation Paper Matte Double-sided
- Epson Ultra Premium Presentation Paper Matte
- Epson Brochure & Flyer Paper Matte Double-sided
- Epson Premium Photo Paper Glossy
- Epson Ultra Premium Photo Paper Glossy
- Epson Photo Paper Glossy

- Epson Premium Photo Paper Semi-gloss

Borderless Paper Sizes

- 4 x 6 inches (102 x 152 mm)
- 5 x 7 inches (127 x 178 mm)
- 8 x 10 inches (203 x 254 mm)
- Letter (8.5 x 11 inches [216 x 279 mm])

Parent topic: [Loading Paper](#)

Paper or Media Type Settings

For this paper	Select this paper Type or Media Type setting
Plain paper Epson Bright White Paper Epson Presentation Paper Matte Epson Photo Quality Self-adhesive Sheets Epson Iron-on Cool Peel Transfer paper	Plain Paper/Bright White Paper
Epson Ultra Premium Photo Paper Glossy	Ultra Premium Photo Paper Glossy
Epson Premium Photo Paper Glossy	Premium Photo Paper Glossy
Epson Photo Paper Glossy	Photo Paper Glossy
Epson Premium Photo Paper Semi-gloss	Premium Photo Paper Semi-Gloss
Epson Premium Presentation Paper Matte Epson Premium Presentation Paper Matte Double-sided Epson Ultra Premium Presentation Paper Matte Epson Brochure & Flyer Paper Matte Double-sided	Premium Presentation Paper Matte
Envelopes	Envelope

Note: The settings listed here are available only when printing from your computer; they do not apply to your product's control panel settings.

Parent topic: [Loading Paper](#)

Related references

[Paper Type Settings - Copying](#)

Placing Originals on the Product

Follow the instructions here to place your original documents or photos on the product.

Caution: Do not place anything on top of your product or use its cover as a writing surface to avoid damaging it.

[Placing Originals on the Scanner Glass](#)

[Placing Originals in the Automatic Document Feeder](#)

Placing Originals on the Scanner Glass

You can place originals up to this size on the scanner glass: Letter (8.5 × 11 inches [216 × 279 mm]) or A4 (8.3 × 11.7 inches [210 × 297 mm]).

1. Open the document cover.

Caution: Do not lift up the document cover so high that the scanner unit lifts at the same time.

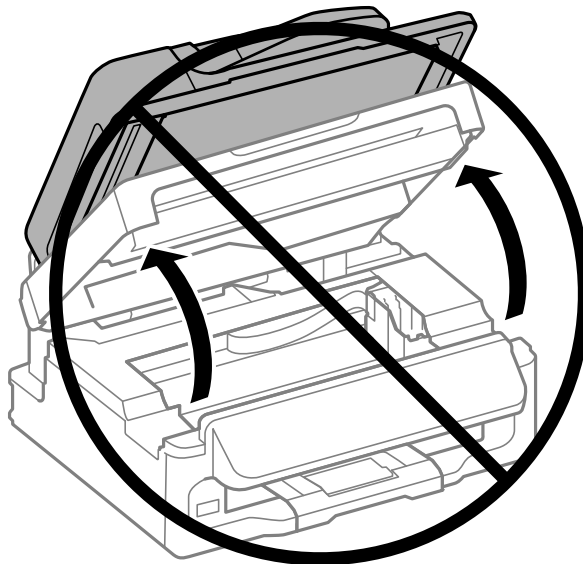

2. Place your original facedown on the scanner glass with the top facing as shown. Slide the original to the edges of the indicated corner.

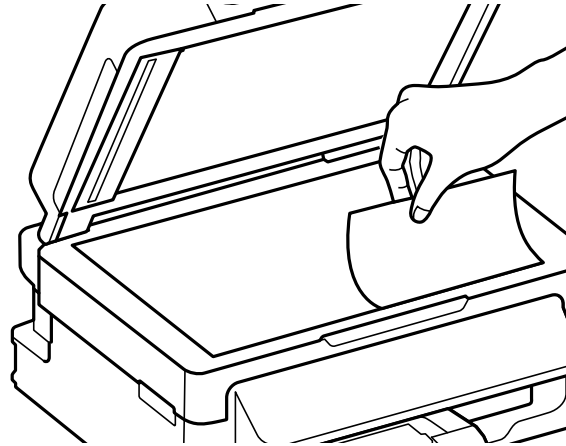

Note: You can place multiple originals on the scanner glass. Just make sure they are at least 0.8 inch (20 mm) away from each other.

3. Close the document cover gently to keep your original in place.

Parent topic: [Placing Originals on the Product](#)

Related topics

[Copying](#)

[Scanning](#)

Placing Originals in the Automatic Document Feeder

You can place multi-page original documents in the Automatic Document Feeder (ADF). Make sure the originals meet the Automatic Document Feeder specifications before loading them.

Caution: Make sure your originals are not creased or folded, and do not contain holes, staples, tape, or other materials that could obstruct the feeder.

1. Slide the ADF edge guide outward.

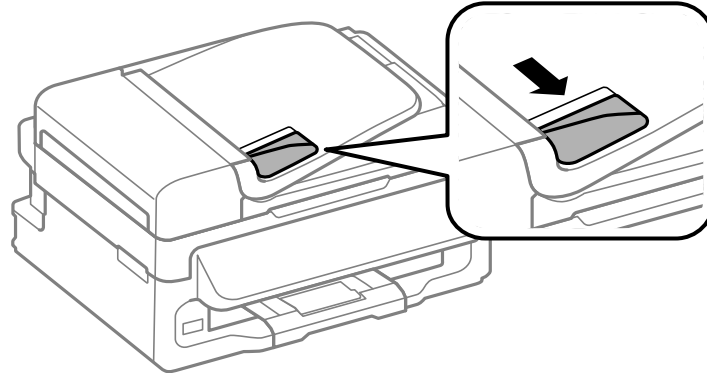

2. Fan your stack of originals and tap them gently on a flat surface to even the edges.

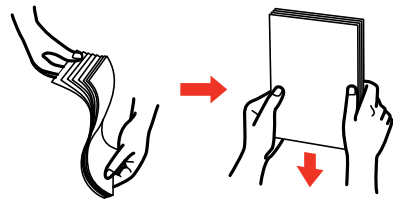

3. Insert the originals into the ADF faceup and top-edge first. The **ADF** light on the control panel turns on.

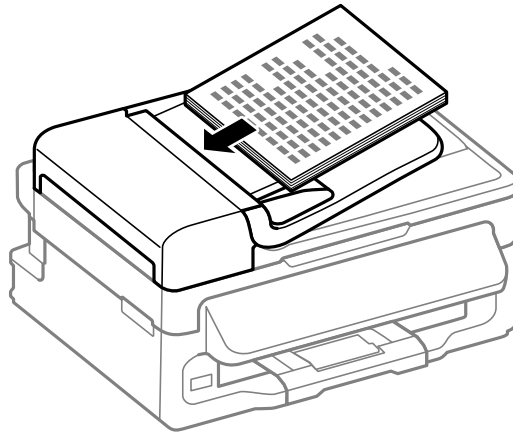

4. Slide the ADF edge guide against the originals, but not too tightly.

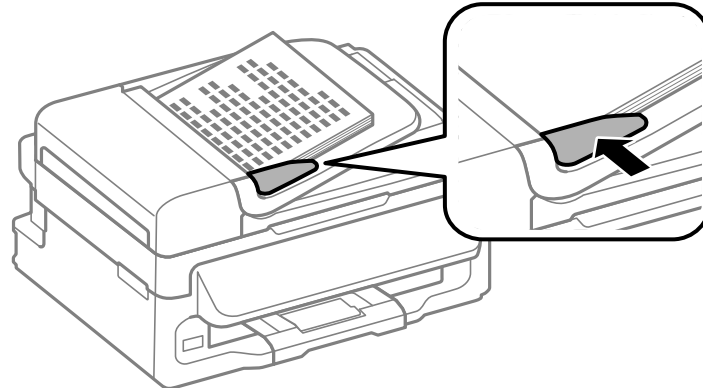

Parent topic: [Placing Originals on the Product](#)

Related references

[Automatic Document Feeder \(ADF\) Specifications](#)

Related topics

[Copying](#)

[Scanning](#)

Copying

See the information here to copy documents or photos using your product.

Note: Copies may not be exactly the same size as your originals.

[Copying Documents or Photos](#)

[Copying ID Cards](#)

Copying Documents or Photos

You can copy documents or photos onto various sizes and types of paper, including Epson special papers.

1. Place your original document or photo on the scanner glass, or place multi-page documents in the ADF.

Note: Depending on the copy settings you select when copying originals placed in the ADF, your product may instruct you to copy using the scanner glass instead.



2. Load the paper you want to print on.

Note: Load only the recommended number of sheets.

3. Press the  **Copy** button.

You see this screen:



4. To print more than one copy, press the up or down arrow buttons to select the number (up to 99).
5. If you need to adjust the darkness of your copy, press the left or right arrow buttons to change the **Density** setting.
6. To change any of the print settings displayed on the LCD screen, press the  **Menu** button, select **Paper and Copy Settings**, press the **OK** button, and select the necessary settings.
7. When you are ready to copy, press one of the  **Start** buttons.

Note: To cancel printing, press the  **Stop/Reset** button.

[Paper Type Settings - Copying](#)

[Paper Size Settings - Copying](#)

[Copying Options](#)

Parent topic: [Copying](#)

Related references

[Automatic Document Feeder \(ADF\) Specifications](#)

Related topics

[Loading Paper](#)

[Placing Originals on the Product](#)

Paper Type Settings - Copying

Select a **Paper Type** setting that matches the paper you loaded.

Paper type loaded	Paper Type setting
Plain paper Epson Bright White Paper Epson Presentation Paper Matte Epson Photo Quality Self-adhesive Sheets Epson Iron-on Cool Peel Transfer paper	Plain Paper
Epson Brochure & Flyer Paper Matte Double-sided Epson Ultra Premium Presentation Paper Matte Epson Premium Presentation Paper Matte Epson Premium Presentation Paper Matte Double-sided Epson Ultra Premium Photo Paper Glossy Epson Premium Photo Paper Semi-gloss Epson Premium Photo Paper Glossy Epson Photo Paper Glossy	Photo Paper

Parent topic: [Copying Documents or Photos](#)

Related references

[Paper or Media Type Settings](#)

Paper Size Settings - Copying

Select the **Paper Size** setting that matches the paper you loaded.

Note: You can copy photos only on these paper sizes.

- 4 × 6 inches (102 × 152 mm)
- 5 × 7 inches (127 × 178 mm)
- Letter (8.5 × 11 inches [216 × 279 mm])
- A4 (8.3 × 11.7 inches [210 × 297 mm])

Parent topic: [Copying Documents or Photos](#)

Copying Options

Select the copying options you want to use for your copies.

Note: Not all options or settings may be available, depending on other copying settings.

Copying option	Available settings	Description
Density	Various levels	Adjusts the lightness or darkness of copies
Layout	With Border	Leaves a small margin around the image
	Borderless	Expands the image to the edge of the paper (slight cropping may occur)
Reduce/Enlarge	Actual Size	Copies at 100% size, unless you select a different percentage as the Custom Size setting
	Auto Fit Page	Automatically sizes the image to fit the selected paper size setting
	Legal->Letter and other conversions	Automatically converts from one size to another
	Custom Size	Automatically sizes the image by the percentage you select as the Custom Size setting
Paper Size	Various sizes	Selects the paper size for the copy printout
Paper Type	Plain Paper	Adjusts printer settings for the selected paper type
	Photo Paper	
Quality	Draft	Provides lower quality for draft copies
	Standard Quality	Provides good quality for most copies
	Best	Provides the highest quality for special copies

Parent topic: [Copying Documents or Photos](#)

Copying ID Cards

You can copy both sides of an ID card on one sheet of paper.





1. Load plain paper in one of these sizes: Letter (8.5 × 11 inches [216 × 279 mm]) or A4 (8.3 × 11.7 inches [210 × 297 mm]).

Note: Load only the recommended number of sheets.

2. Press the  **Copy** button.

You see this screen:



3. To print more than one copy, press the up or down arrow buttons to select the number (up to 99).
4. Press the  **Menu** button, press the up or down arrow buttons to select **ID Card Copy**, and press the **OK** button.
5. Press the up or down arrow buttons to select your paper size, and press the **OK** button again.
6. When you are ready to copy, press one of the  **Start** buttons.
You see instructions on the LCD screen. Press the **OK** button to see how to place your card.
7. Place your ID card facedown on the scanner glass.
8. Press the same  **Start** button again.
Your product scans the front side of the card.
9. When your product finishes scanning the front side, turn the card over, then press the same  **Start** button again.
Your product scans the back side of the card and then begins printing.

Note: To cancel printing, press the  **Stop/Reset** button.

Parent topic: [Copying](#)

Related topics

[Loading Paper](#)

[Placing Originals on the Product](#)

Printing From a Computer

Before printing from your computer, make sure you have set up your product and installed its software as described on the *Start Here* sheet.

Note: If you have an Internet connection, it is a good idea to check for updates to your product software on Epson's support website. If you see a Software Update screen, select **Enable automatic checking** and click **OK**. The update scans your system to see if you have the latest product software. Follow the on-screen instructions.

[Printing with Windows](#)

[Printing with Mac OS X](#)

[Cancelling Printing Using a Product Button](#)

Related tasks

[Checking for Software Updates](#)

Printing with Windows

You can print with your product using any Windows printing program, as described in these sections.

[Selecting Basic Print Settings - Windows](#)

[Selecting Double-sided Printing Settings - Windows](#)

[Selecting Additional Layout and Print Options - Windows](#)

[Selecting a Printing Preset - Windows](#)

[Printing Your Document or Photo - Windows](#)

[Selecting Default Print Settings - Windows](#)

[Changing Automatic Update Options](#)

Parent topic: [Printing From a Computer](#)

Selecting Basic Print Settings - Windows

Select the basic settings for the document or photo you want to print.

1. Open a photo or document for printing.

2. Select the print command in your application.

Note: You may need to select a print icon on your screen, the **Print** option in the **File** menu, or another command. See your application's help utility for details.

3. If necessary, select your product name as the printer you want to use.

Note: You may also need to select **Properties** or **Preferences** to view your print settings.

You see the Main tab of your printer settings window:

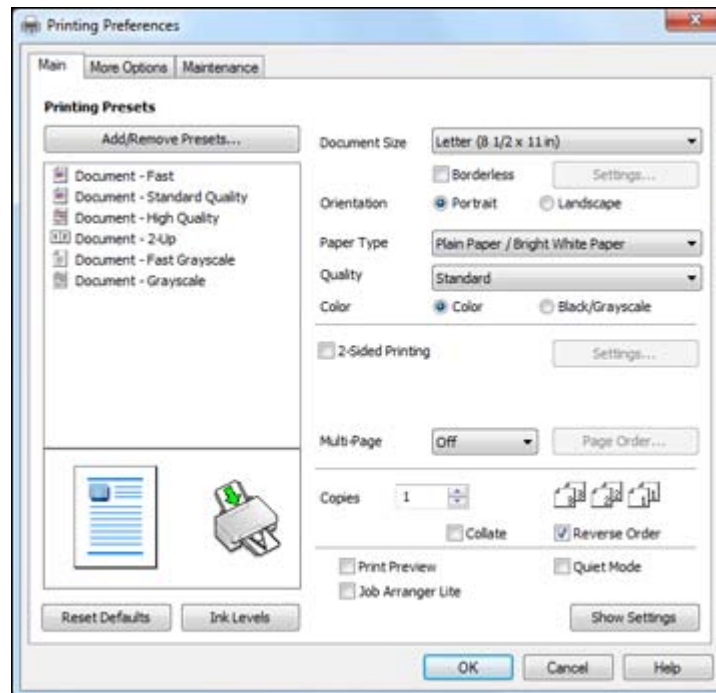

4. Select the size of the paper you loaded as the **Document Size** setting.

Note: You can also select the **User-Defined** setting to create a custom paper size, but you will not be able to use the **Borderless** setting.

5. If you are printing a borderless photo, select **Borderless**. You can click **Settings** to access additional options for borderless printing.

Note: You must select a compatible borderless paper type and size to print without borders. Check the borderless paper compatibility list for details.

6. Select the orientation of your document.

Note: If you are printing an envelope, select **Landscape**.

7. Select the type of paper you loaded as the **Paper Type** setting.

Note: The setting may not exactly match the name of your paper. Check the paper type settings list for details.

8. Select the **Quality** setting that matches the print quality you want to use.

9. Select a Color option:

- To print a color document or photo, select the **Color** setting.
- To print text and graphics in black or shades of gray, select the **Black/Grayscale** setting.

10. To print on both sides of the paper, select the **2-Sided Printing** checkbox and select the options you want.

11. To print multiple pages on one sheet of paper, or print one image on multiple sheets of paper, select one of the settings in the **Multi-Page** menu and select the printing options you want.

12. To print multiple copies and arrange their print order, select the **Copies** options.

13. To preview your job before printing, select **Print Preview**.

14. To save your print job as a project that can be modified and combined with other print jobs, select **Job Arranger Lite**.

15. To reduce noise during printing when you select **Plain Paper/Bright White Paper**, select **Quiet Mode**.

[Print Quality Options - Windows](#)

[Multi-Page Printing Options - Windows](#)

Parent topic: [Printing with Windows](#)

Related references

[Borderless Paper Type Compatibility](#)

[Paper or Media Type Settings](#)

Related tasks

[Printing Your Document or Photo - Windows](#)

[Selecting Double-sided Printing Settings - Windows](#)

Print Quality Options - Windows

You can select any of the available Quality options to fine-tune the quality of your print. Some settings may be unavailable, depending on the paper type and border setting you have chosen.

Draft

For draft printing on plain paper.

Standard

For everyday text and image printing.

High

For photos and graphics with high print quality.

More Settings

Opens a window that lets you choose among levels of speed and quality.

Parent topic: [Selecting Basic Print Settings - Windows](#)

Multi-Page Printing Options - Windows

You can select any of the available options in the Multi-Page menu to set up your multi-page print job.

2-Up and 4-Up

Prints 2 or 4 pages on one sheet of paper. Click the **Page Order** button to select page layout and border options.

2x1 Poster, 2x2 Poster, 3x3 Poster, 4x4 Poster

Prints one image on multiple sheets of paper to create a larger poster. Click the **Settings** button to select image layout and guideline options.

Parent topic: [Selecting Basic Print Settings - Windows](#)

Selecting Double-sided Printing Settings - Windows

You can print on both sides of the paper by selecting the **2-Sided Printing** checkbox on the Main tab.



Note: Some options may be pre-selected or unavailable, depending on other settings you have chosen or if you are accessing the product over a network or as a shared printer.

1. Select the **2-Sided Printing** checkbox.
2. Click the **Settings** button.

You see this window:

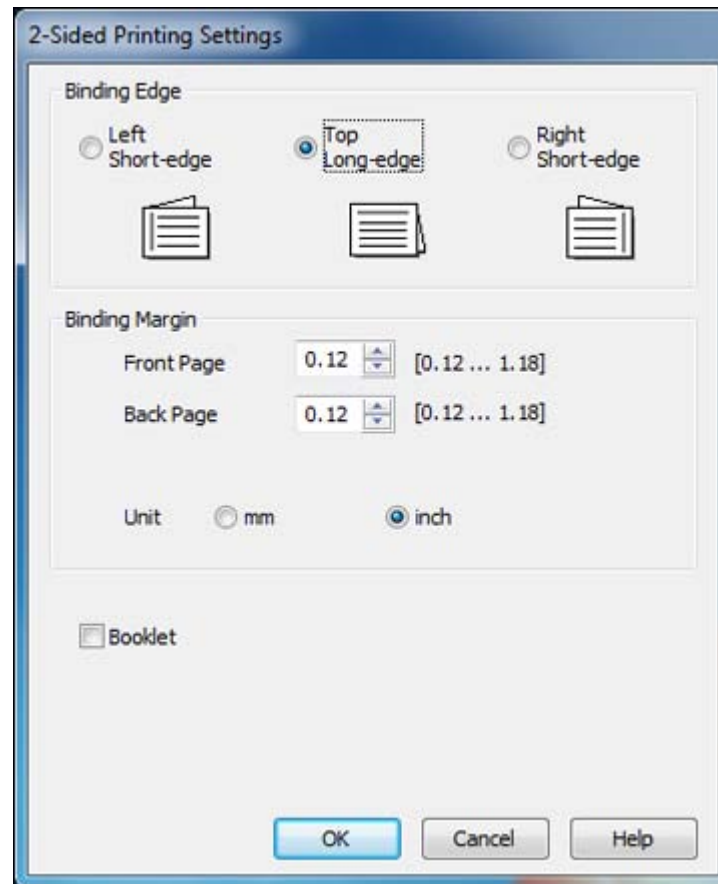

3. Select the double-sided printing options you want to use.
4. Click **OK** to return to the Main tab.

5. Print a test copy of your double-sided document to test the selected settings.
6. Follow any instructions displayed on the screen during printing.

Note: The surface of the paper may smear during double-sided printing. Make sure the ink has dried before reloading the paper.

[Double-sided Printing Options - Windows](#)

Parent topic: [Printing with Windows](#)

Double-sided Printing Options - Windows

You can select any of the available options on the 2-Sided Printing Settings window to set up your double-sided print job.

Binding Edge Options

Select a setting that orients double-sided print binding in the desired direction.

Binding Margin Options

Select options that define a wider margin to allow for binding.

Booklet

Select the **Booklet** checkbox to print double-sided pages as a booklet.

Parent topic: [Selecting Double-sided Printing Settings - Windows](#)

Selecting Additional Layout and Print Options - Windows

You can select a variety of additional layout and printing options for your document or photo on the More Options tab.

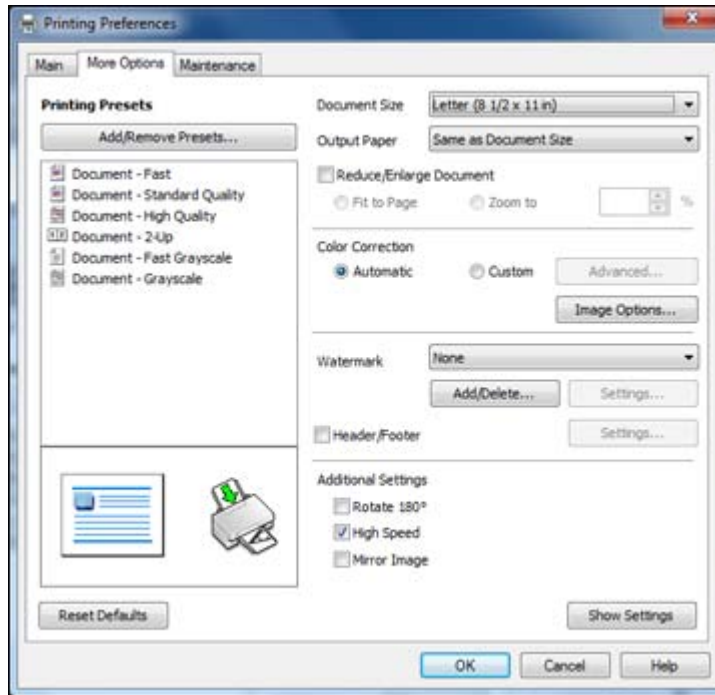

1. To change the size of your printed document or photo, select the **Reduce/Enlarge Document** checkbox and select one of these sizing options:
 - Select the **Fit to Page** option to size your image to fit the paper you loaded. Select the size of the your document or photo as the **Document Size** setting, and the size of your paper as the **Output Paper** setting.
 - Select the **Zoom to** option to reduce or enlarge your document or photo by a specific percentage. Select the percentage in the % menu.
2. Select one of the following Color Correction options:
 - Select **Automatic** to automatically adjust the sharpness, brightness, contrast, and color saturation for your image.
 - Select **Custom** and click the **Advanced** button to manually adjust the color correction settings or turn off color management in your printer software.
 - Select **Image Options** to access additional settings for improving printed images.
3. To add a watermark to your printout, select Watermark settings.

4. To add a header or footer to your document, select **Header/Footer**, then select **Settings** to customize the text and location.
5. Select any of the Additional Settings options to customize your print.

[Custom Color Correction Options - Windows](#)

[Image Options and Additional Settings - Windows](#)

[Header/Footer Settings - Windows](#)

Parent topic: [Printing with Windows](#)

Related tasks

[Printing Your Document or Photo - Windows](#)

Custom Color Correction Options - Windows

You can select any of the available options in the Color Correction window to customize the image colors for your print job.

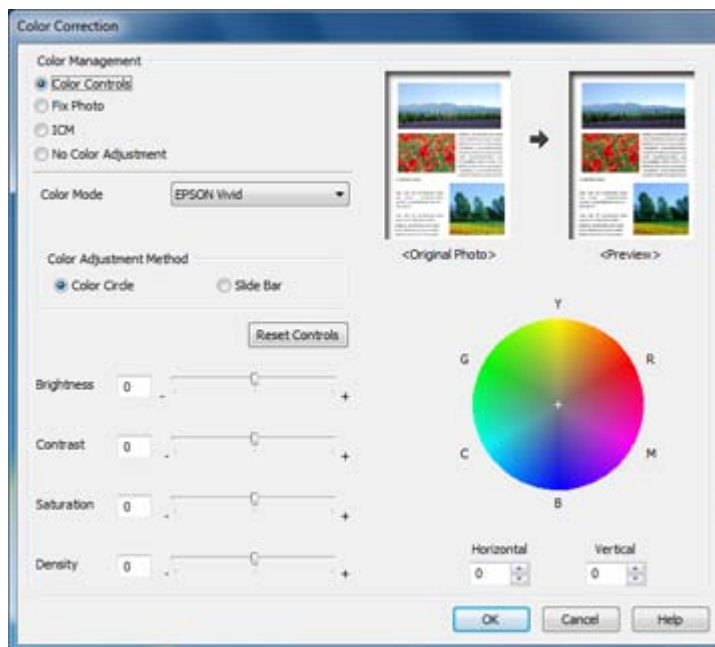

Color Controls

Lets you select a **Color Mode** setting, individual settings for **Brightness, Contrast, Saturation,** and **Density,** and individual color tones. Depending on the selected color mode, you can also adjust the midtone density using the **Gamma** setting.

Fix Photo

Improves the color, contrast, and sharpness of flawed photos.

Note: Fix Photo uses a sophisticated face recognition technology to optimize photos that include faces. For this to work, both eyes and the nose must be visible in the subject's face. If your photo includes a face with an intentional color cast, such as a statue, you may want to turn off **Fix Photo** to retain the special color effects.

No Color Adjustment

Turns off color management in your printer software so you can manage color using only your application software.

Parent topic: [Selecting Additional Layout and Print Options - Windows](#)

Image Options and Additional Settings - Windows

You can select any of the Image Options and Additional Settings to customize your print. Some options may be pre-selected or unavailable, depending on other settings you have chosen.

Image Options**Edge Smoothing**

Smooths jagged edges in low-resolution images such as screen captures or images from the Web.

Fix Red-Eye

Reduces or removes red-eye in photos.

Additional Settings Options**Rotate 180°**

Prints the image rotated 180° from its original orientation.

High Speed

Speeds up printing, but may reduce print quality.

Mirror Image

Flips the printed image left to right.

Parent topic: [Selecting Additional Layout and Print Options - Windows](#)

Header/Footer Settings - Windows

You can select any of the Header/Footer Settings options to add headers or footers when you print. The items are available to print at the top or bottom of your pages, in either the left, right, or center of the page.

Note: These settings are not saved with your document.



You can select to print the following information, which comes from the Windows Control Panel on your computer:

- User Name
- Computer Name
- Date
- Date/Time

Parent topic: [Selecting Additional Layout and Print Options - Windows](#)

Selecting a Printing Preset - Windows

For quick access to common groups of print settings, you can select a printing preset on the Main or More Options tab.

Note: You can create your own preset by clicking the **Add/Remove Presets** button.

1. Click the **Main** or **More Options** tab.
You see the available **Printing Presets** on the left:

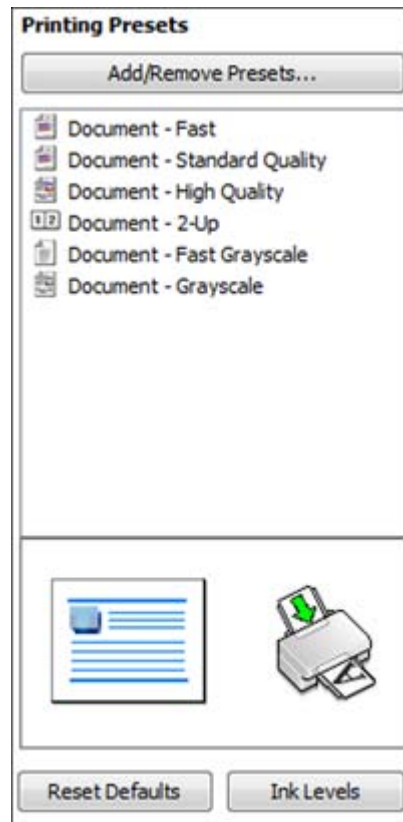

2. Place your cursor over one of the **Printing Presets** to view its list of settings.
3. Use any of the available options on the screen to control your printing presets.
4. To choose an option for printing, select it.
5. Click **OK**.

Parent topic: [Printing with Windows](#)

Printing Your Document or Photo - Windows

Once you have selected your print settings, you are ready to save your settings and print.

1. Click **OK** to save your settings.

You see your application's Print window, such as this one:

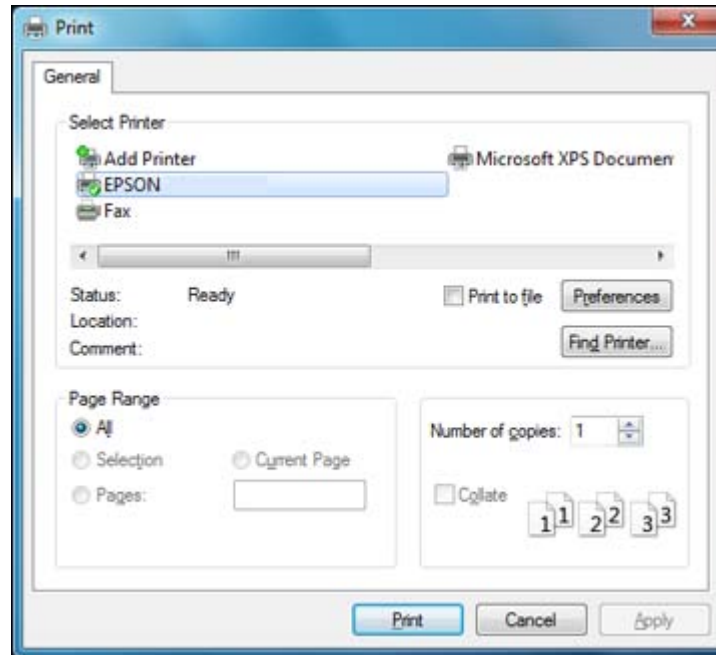

2. Click **OK** or **Print** to start printing.

Parent topic: [Printing with Windows](#)

Selecting Default Print Settings - Windows

When you change your print settings in a program, the changes apply only while you are printing in that program session. If you want to change the print settings you use in all your Windows programs, you can select new default print settings.

1. Right-click the product icon in the Windows taskbar.
2. Select **Printer Settings**.

You see the printer settings window:

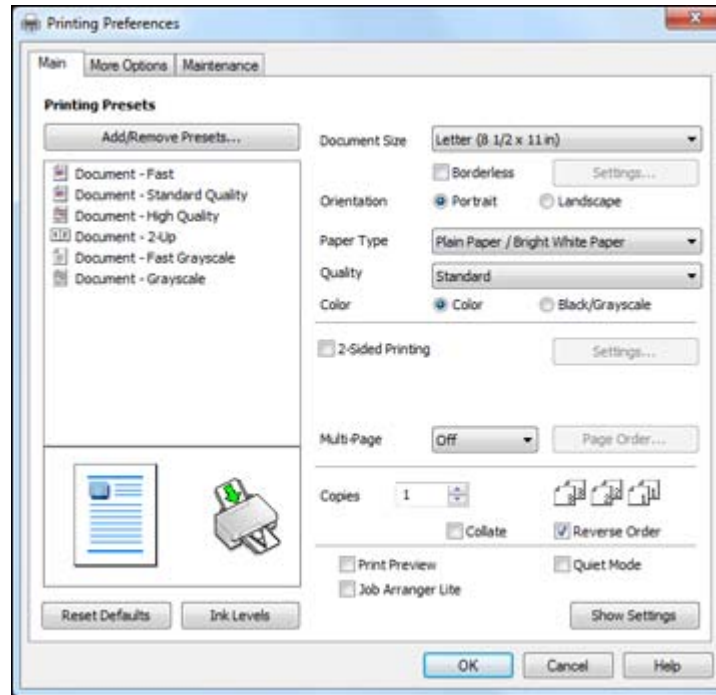

3. Select the print settings you want to use as defaults in all your Windows programs.

4. Click **OK**.

These settings are now the defaults selected for printing. You can still change them as needed for printing in any program session.

[Changing the Language of the Printer Software Screens](#)

Parent topic: [Printing with Windows](#)

Changing the Language of the Printer Software Screens

You can change the language used on the Windows printer software screens.

1. Right-click the product icon in the Windows taskbar.
2. Select **Printer Settings**.
You see the printer settings window.
3. Click the **Maintenance** tab.

You see the maintenance options:

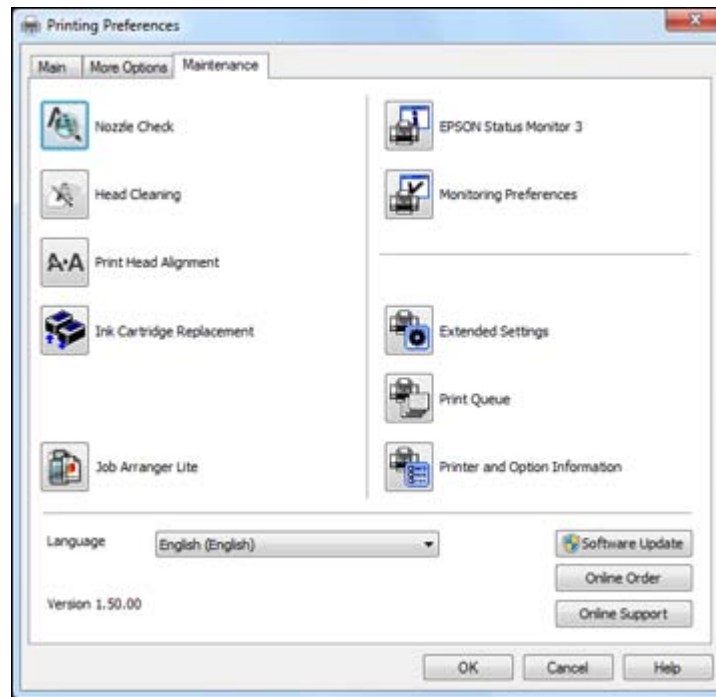

4. Select the language you want to use as the **Language** setting.
5. Click **OK** to close the printer software window.

The printer software screens appear in the language you selected the next time you access them.

Parent topic: [Selecting Default Print Settings - Windows](#)

Changing Automatic Update Options

Your printer software for Windows automatically checks for updates to the product software. You can change how often the software checks for updates or disable this feature.

1. Right-click the product icon in the Windows taskbar.
2. Select **Software Update Settings**.

You see this window:

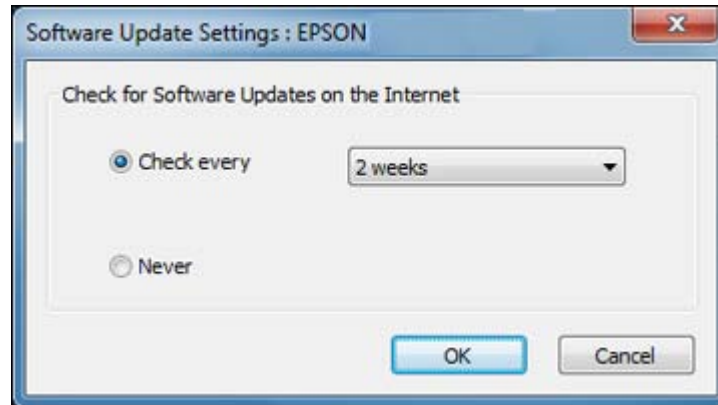

3. Do one of the following:
 - To change how often the software checks for updates, select a setting in the **Check every** menu.
 - To disable the automatic update feature, select the **Never** option.
4. Click **OK** to exit.

Note: If you choose to disable the automatic update feature, you can check for updates manually.

Parent topic: [Printing with Windows](#)

Related tasks

[Checking for Software Updates](#)

Printing with Mac OS X

You can print with your product using any Mac OS X printing program, as described in these sections.

[Selecting Basic Print Settings - Mac OS X](#)

[Selecting Page Setup Settings - Mac OS X](#)

[Selecting Print Layout Options - Mac OS X](#)

[Managing Color - Mac OS X](#)

[Selecting Printing Preferences - Mac OS X](#)

[Printing Your Document or Photo - Mac OS X](#)

Parent topic: [Printing From a Computer](#)

Selecting Basic Print Settings - Mac OS X

Select the basic settings for the document or photo you want to print.

1. Open a photo or document for printing.
2. Select the print command in your application.

Note: You may need to select a print icon on your screen, the **Print** option in the File menu, or another command. See your application's help utility for details.

3. Select your product as the **Printer** setting.

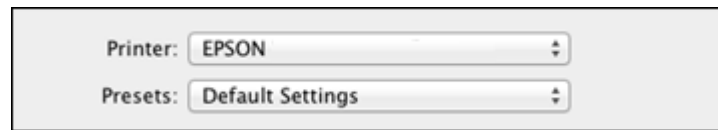

The image shows a screenshot of a print settings dialog box. It contains two dropdown menus. The first dropdown menu is labeled 'Printer:' and has 'EPSON' selected. The second dropdown menu is labeled 'Presets:' and has 'Default Settings' selected. Both dropdown menus have a small arrow icon on the right side.

4. If necessary, click the arrow next to the Printer setting or the **Show Details** button to expand the print window.

You see the expanded printer settings window for your product:

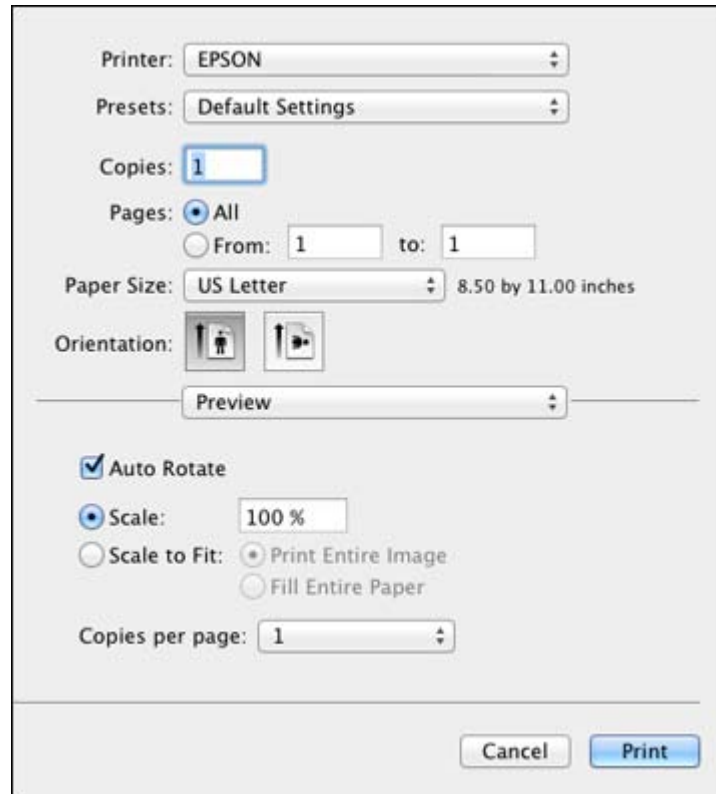

Note: The print window may look different, depending on the version of Mac OS X and the application you are using.

5. Select the **Copies** and **Pages** settings as necessary.

Note: If you do not see these settings in the print window, check for them in your application before printing.

6. Select the page setup options: **Paper Size** and **Orientation**.

Note: If you do not see these settings in the print window, check for them in your application before printing. They may be accessible by selecting **Page Setup** from the File menu.

7. Select any application-specific settings that appear on the screen, such as those shown in the image above for the Preview application.
8. Select **Print Settings** from the pop-up menu.

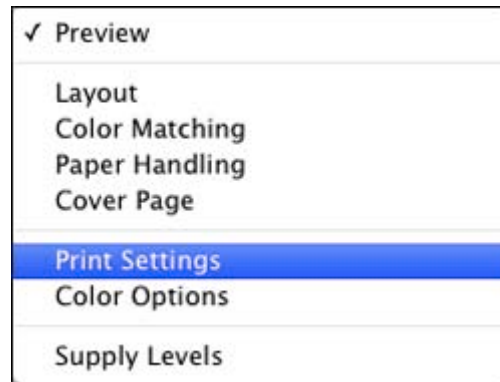

You see these settings:

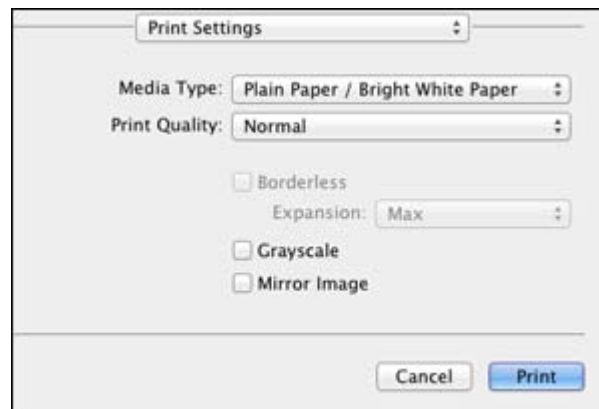

9. Select the type of paper you loaded as the **Media Type** setting.

Note: The setting may not exactly match the name of your paper. Check the paper type settings list for details.

10. Select the **Print Quality** setting you want to use.

11. Select any of the available print options.

[Print Quality Options - Mac OS X](#)

[Print Options - Mac OS X](#)

Parent topic: [Printing with Mac OS X](#)

Related references

[Paper or Media Type Settings](#)

Related tasks

[Selecting Page Setup Settings - Mac OS X](#)

[Printing Your Document or Photo - Mac OS X](#)

Print Quality Options - Mac OS X

You can select any of the available Print Quality options to fine-tune the quality of your print. Some settings may be unavailable, depending on the paper type and border setting you have chosen.

Fast Economy

For the fastest printing with draft quality.

Economy

For fast printing with reduced quality.

Normal

For everyday text and image printing.

Fine

For text and graphics with good quality and print speed.

Quality

For photos and graphics with good quality and print speed.

High Quality

For photos and graphics with high print quality.

Best Quality

For the best print quality, but the slowest print speed.

Parent topic: [Selecting Basic Print Settings - Mac OS X](#)

Print Options - Mac OS X

You can select any of the print options to customize your print. Some options may be unavailable, depending on other settings you have chosen.

Expansion

If you selected a borderless paper size setting, this option adjusts the image expansion settings to control printing at the edges of borderless prints.

Grayscale

Prints text and graphics in black or shades of gray.

Mirror Image

Lets you flip the printed image horizontally.

Note: If you select the **Min** option for the Expansion setting, you may see white borders on your printed photo.

Parent topic: [Selecting Basic Print Settings - Mac OS X](#)

Selecting Page Setup Settings - Mac OS X

Depending on your application, you may be able to select the paper size and orientation settings from the print window.

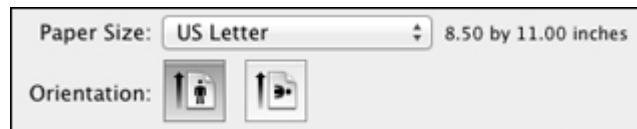

Note: If you do not see these settings in the print window, check for them in your application before printing. They may be accessible by selecting **Page Setup** from the File menu.

1. Select the size of the paper you loaded as the **Paper Size** setting. If you are printing a borderless photo, select the **Borderless** checkbox or a paper size with a **Borderless** option. You can also select a custom setting to create a custom paper size.

Note: You must select a compatible borderless paper type and size to print without borders. Check the borderless paper compatibility list for details.

2. Select the orientation of your document or photo as shown in the print window.

Note: If you are printing an envelope, select the  icon.

Note: You can reduce or enlarge the size of the printed image by selecting **Paper Handling** from the pop-up menu and selecting a scaling option.

Parent topic: [Printing with Mac OS X](#)

Related references

[Borderless Paper Type Compatibility](#)

Selecting Print Layout Options - Mac OS X

You can select a variety of layout options for your document or photo by selecting **Layout** from the pop-up menu on the print window.

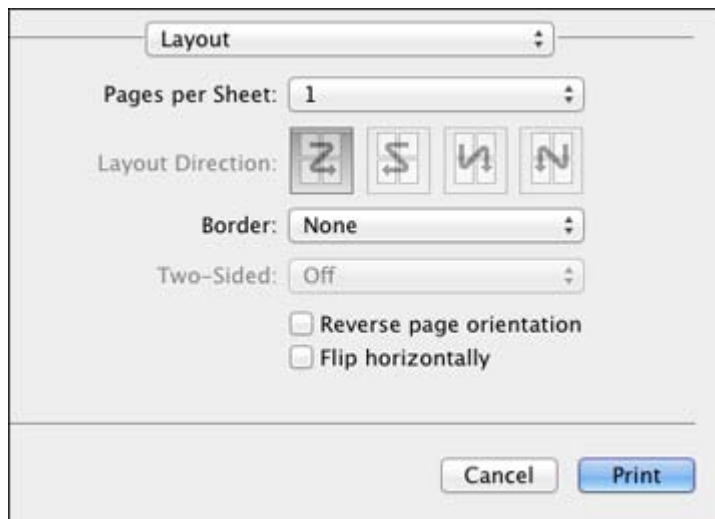

- To print multiple pages on one sheet of paper, select the number of pages in the **Pages per Sheet** pop-up menu. To arrange the print order of the pages, select a **Layout Direction** setting.
- To print borders around each page on the sheet, select a line setting from the **Border** pop-up menu.
- To invert or flip the printed image, select the **Reverse page orientation** or **Flip horizontally** settings.

Parent topic: [Printing with Mac OS X](#)

Managing Color - Mac OS X

You can adjust the Color Matching and Color Options settings to fine-tune the colors in your printout, or turn off color management in your printer software.

1. Select **Color Matching** from the pop-up menu in the print window.



2. Select one of the available options.
3. Select **Color Options** from the pop-up menu in the print window.

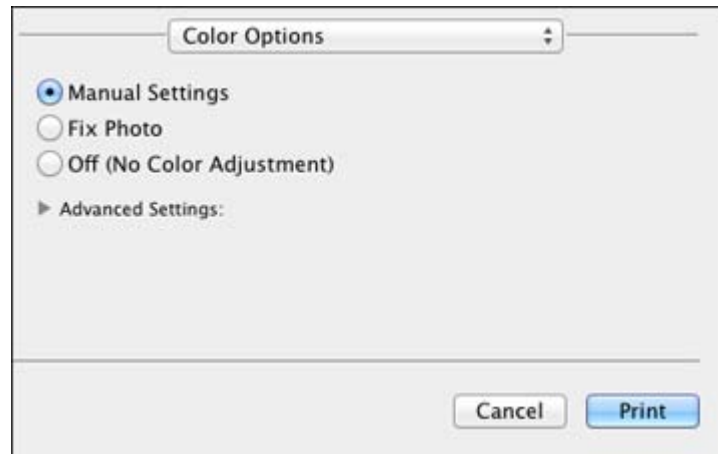

Note: The available settings on the Color Options menu depend on the option you selected on the Color Matching menu.

4. Select one of the available options.
- [Color Matching and Color Options - Mac OS X](#)
Parent topic: [Printing with Mac OS X](#)

Color Matching and Color Options - Mac OS X

You can select from these settings on the **Color Matching** and **Color Options** menus.

Color Matching Settings

EPSON Color Controls

Lets you manage color using controls in your printer software, or turn off color management.

ColorSync

Prints using standard color profiles for your product and paper to help match image colors. You can customize the conversion method and filter settings on the ColorSync pop-up menu in the print window.

Color Options Settings

Manual Settings

Lets you select manual color adjustments. Click the arrow next to **Advanced Settings** and select settings for **Brightness**, **Contrast**, **Saturation**, and individual color tones. You can also select a color **Mode** setting for printing photos and graphics and the **Fix Red-Eye** setting to reduce or remove red-eye in photos. Depending on the selected color mode, you can also adjust the midtone density using the **Gamma** setting.

Fix Photo

Improves the color, contrast, and sharpness of flawed photos. Click the arrow next to **Advanced Settings** and select the **Fix Red-Eye** setting to reduce or remove red-eye in photos.

Note: Fix Photo uses a sophisticated face recognition technology to optimize photos that include faces. For this to work, both eyes and the nose must be visible in the subject's face. If your photo includes a face with an intentional color cast, such as a statue, you may want to turn off **Fix Photo** to retain the special color effects.

Off (No Color Adjustment)

Turns off color management in your printer software so you can manage color using only your application software.

Parent topic: [Managing Color - Mac OS X](#)

Selecting Printing Preferences - Mac OS X

You can select printing preferences that apply to all the print jobs you send to your product.

1. In the Apple menu or the Dock, select **System Preferences**.
2. Select **Print & Fax** or **Print & Scan**, select your product, and select **Options & Supplies**.

3. Select **Driver**.

You see this screen:

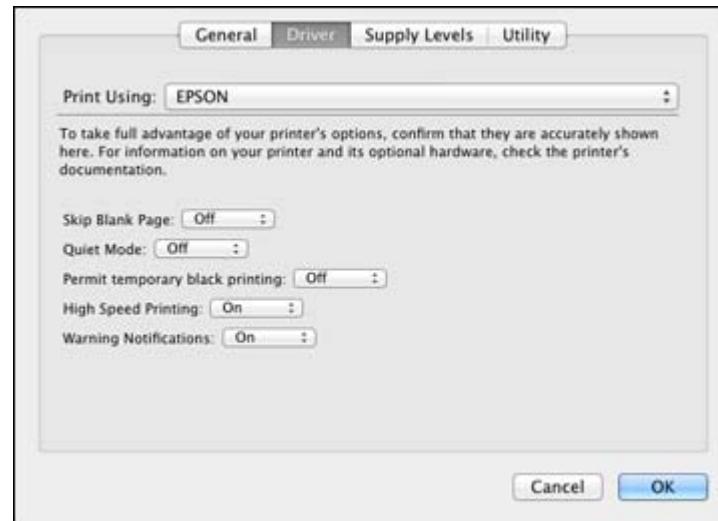

4. Select any of the available printing preferences.

5. Click **OK**.

[Printing Preferences - Mac OS X](#)

Parent topic: [Printing with Mac OS X](#)

Printing Preferences - Mac OS X

You can select from these settings on the Driver tab.

Skip Blank Page

Ensures that your product does not print pages that contain no text or images.

Quiet Mode

Lessens noise during printing when you select **Plain Paper/Bright White Paper** as the paper Type or Media Type setting.

Permit temporary black printing

Allows you to print using black ink when a color ink cartridge is expended.

High Speed Printing

Speeds up printing, but may reduce print quality.

Warning Notifications

Lets you choose whether or not to receive warning notifications from the printer software when ink is low.

Parent topic: [Selecting Printing Preferences - Mac OS X](#)

Printing Your Document or Photo - Mac OS X

Once you have selected your print settings, you are ready to print.

Click **Print** at the bottom of the print window.

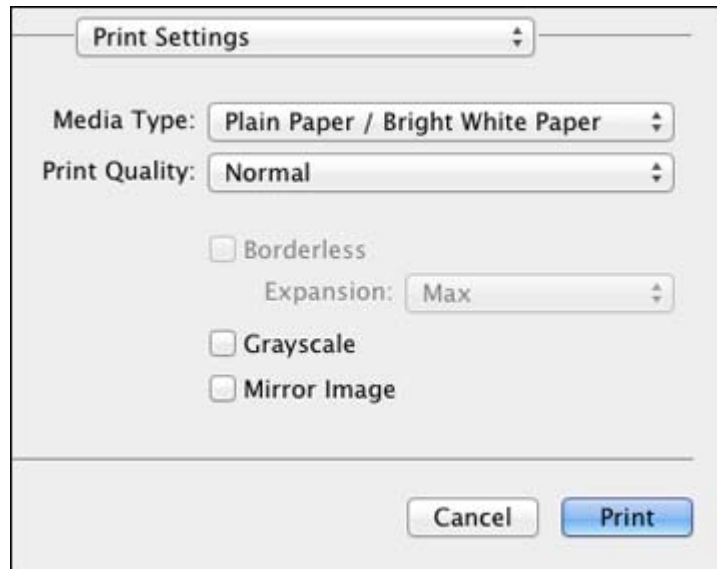

[Checking Print Status - Mac OS X](#)

Parent topic: [Printing with Mac OS X](#)

Checking Print Status - Mac OS X

During printing, you can view the progress of your print job, control printing, and check ink cartridge status.

1. Click the printer icon when it appears in the Dock.

You see the print status window:

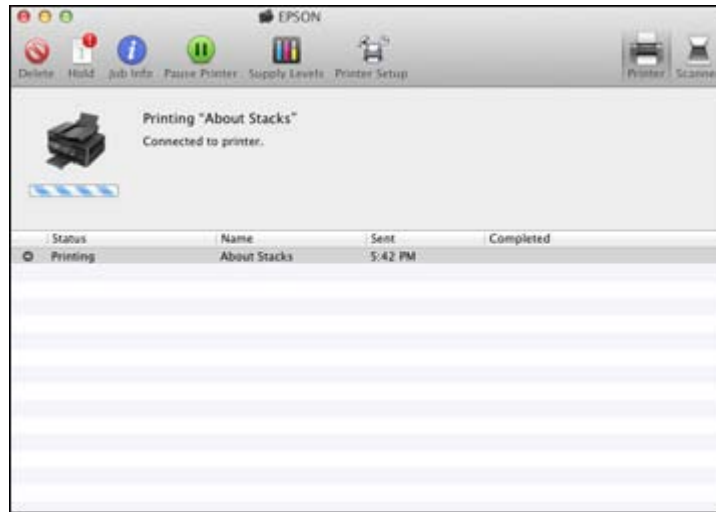

2. Select the following options as necessary:

- To cancel printing, click the print job and click **Delete**.
- To pause a print job, click the print job and click **Hold**. To resume a print job, click the print job marked "Hold" and click **Resume**.
- To pause printing for all queued print jobs, click **Pause Printer**.
- To check ink status, click **Supply Levels**.

Parent topic: [Printing Your Document or Photo - Mac OS X](#)

Cancelling Printing Using a Product Button

If you need to cancel printing, press the  **Stop/Reset** button on your product.

Parent topic: [Printing From a Computer](#)

Scanning

You can scan original documents or photos and save them as digital files.

[Starting a Scan](#)

[Selecting Epson Scan Settings](#)

[Scanning with Mac OS X 10.6/10.7/10.8 Using Image Capture](#)

[Scanning Special Projects](#)

Starting a Scan

After placing your original documents or photos on your product for scanning, start scanning using one of these methods.

[Starting a Scan Using the Product Control Panel](#)

[Starting a Scan Using the Epson Scan Icon](#)

[Starting a Scan from a Scanning Program](#)

Parent topic: [Scanning](#)

Related topics

[Placing Originals on the Product](#)

Starting a Scan Using the Product Control Panel

You can scan an image using your product's control panel buttons.

Your product automatically selects suitable default scan settings, but you can view or change them as necessary.

1. Make sure you installed the product software and connected the product to your computer or network.
2. Press the  **Scan** button.

The scan options are displayed:

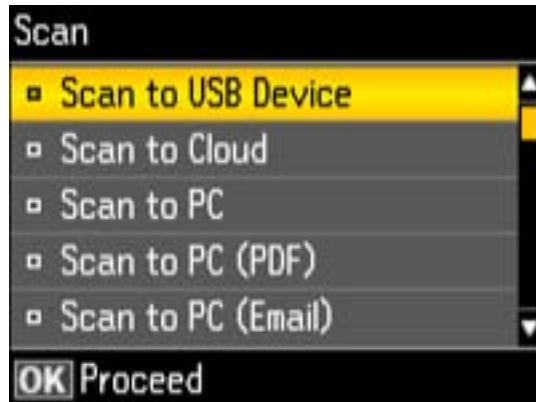

3. Press the up or down arrow buttons to select a scan option and press the **OK** button.
 - **Scan to USB Device** saves your scan file on a USB flash drive and lets you select the file format, resolution, and other settings.
 - **Scan to Cloud** sends your scanned files to a destination that you have registered with Epson Connect.
 - **Scan to PC** saves your scan as a JPEG file to your computer or as an image capture in Mac OS X 10.6/10.7/10.8.
 - **Scan to PC (PDF)** saves your scan as a PDF file to your computer or as an image capture in Mac OS X 10.6/10.7/10.8.
 - **Scan to PC (Email)** scans your original and attaches it to a message in your e-mail program. You can select the e-mail program you want to use and resize your image, if necessary, from an option screen on your computer.

Note: This works with MAPI-type email such as Microsoft Outlook, Windows Live Mail, Mac Mail, and Entourage, but not web-based email such as Gmail.
 - **Scan to PC (WSD)** lets you manage network scanning in Windows 7 or Windows Vista (English only).

Note: To use this feature, you must first set up WSD (Web Services for Devices) on the computer you want to scan to.

4. To scan to your computer, you first need to select how you connected your product to your computer:
 - If your product is connected directly to your computer with a USB cable, press the up or down arrow buttons to select **USB Connection**.
 - If your product is connected to your computer over a network, press the up or down arrow buttons to select the computer name from the list.
5. Press the **Start Color** button to start scanning.

[Scan to USB Device Options](#)

[Changing Default Scan Button Settings](#)

Parent topic: [Starting a Scan](#)

Related tasks

[Inserting a USB Flash Drive](#)

Scan to USB Device Options

Select the **Scan to USB Device** options you want to use.

Scan to USB Device setting	Available options	Description
Format	JPEG PDF	JPEG: for photos PDF: for documents
Scan Area	Letter Legal A4 Auto Cropping Max Area	Selects the page size for documents or special settings for photos. Auto Cropping: for photos with dark edges Max Area: for most photos
Document	Text Photograph	Selects the type of original you are scanning
Resolution	200 dpi 300 dpi 600 dpi	200 dpi: for e-mailing or posting on the web 300 dpi: for printing or OCR 600 dpi: for highest quality printing

Scan to USB Device setting	Available options	Description
Contrast	-4 to +4	Press the arrow buttons to decrease or increase image contrast
Document Orientation	Portrait Landscape	For PDF documents

Parent topic: [Starting a Scan Using the Product Control Panel](#)

Changing Default Scan Button Settings

You can view or change the default scan settings your product uses when you scan to your computer using the product buttons. You do this using the Event Manager program.

1. Do one of the following to open Event Manager:
 - **Windows 8:** Navigate to the **Start** screen and select **Event Manager**.
 - **Windows (other versions):** Click  or **Start > All Programs** or **Programs > EPSON Software > Event Manager**.
 - **Mac OS X:** Open the **Applications** folder, click **Epson Software**, and click **Event Manager**.
2. Open the **Scanner** (Windows) or **Select Scanner** (Mac OS X) drop-down list and select your product, if necessary.
3. Click **Make Job Settings**.
4. Open the **Edit Job Settings** drop-down list and select the scan button settings you want to view or change.
5. Change the settings as necessary.
6. Click **OK**.
7. Click **Close** to close the Event Manager window.

Parent topic: [Starting a Scan Using the Product Control Panel](#)

Starting a Scan Using the Epson Scan Icon

You can start the Epson Scan program to select scan settings, scan, and save the scanned image to a file.

- **Windows:** Double-click the **EPSON Scan** icon on your computer desktop.

- **Mac OS X:** Open the **Applications** folder, open the **Epson Software** folder, and double-click the **EPSON Scan** icon.

Note: With Mac OS X 10.6, 10.7, or 10.8, in addition to scanning with Image Capture, you can download and install Epson Scan scanning software. Epson Scan provides additional image adjustment and photo correction features for enhancing scanned images, and provides an interface for TWAIN-compliant OCR scanning software, such as ABBYY FineReader. To download Epson Scan, visit Epson's driver download site ([U.S. downloads](#) or [Canadian downloads](#)).

You see an Epson Scan window like this:

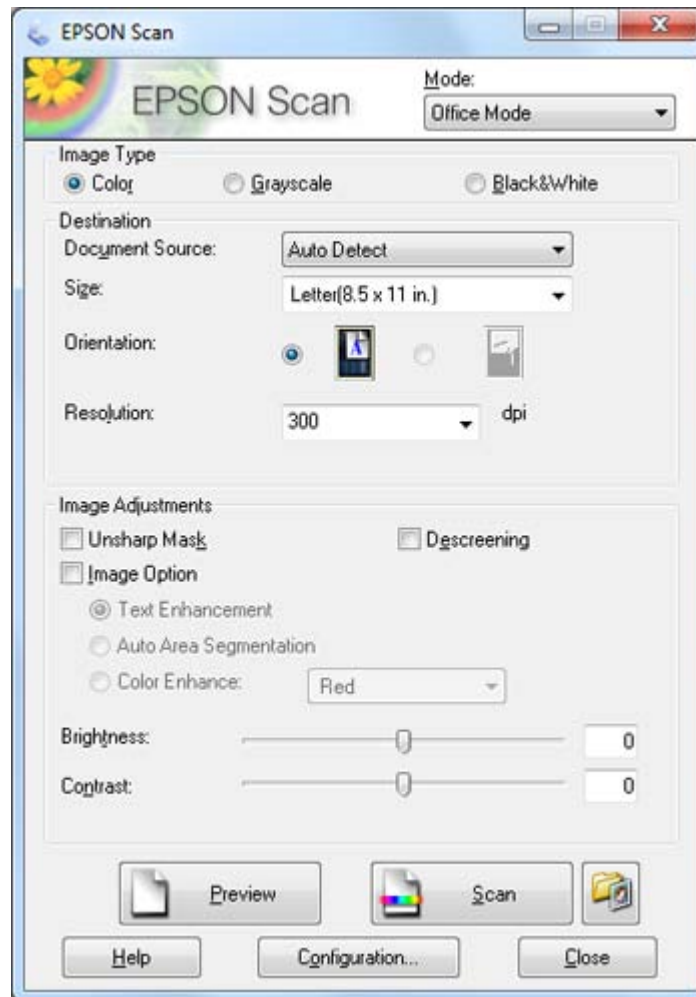

Parent topic: [Starting a Scan](#)

Related tasks

[Scanning with Mac OS X 10.6/10.7/10.8 Using Image Capture](#)

Related topics

[Selecting Epson Scan Settings](#)

Starting a Scan from a Scanning Program

You can start Epson Scan from a scanning program to select scan settings, scan, and open the scanned image in the program.

Note: With Mac OS X 10.6, 10.7, or 10.8, in addition to scanning with Image Capture, you can download and install Epson Scan scanning software. Epson Scan provides additional image adjustment and photo correction features for enhancing scanned images, and provides an interface for TWAIN-compliant OCR scanning software, such as ABBYY FineReader. To download Epson Scan, visit Epson's driver download site ([U.S. downloads](#) or [Canadian downloads](#)).

1. Open your scanning program and select its scanning option. (See your scanning program help for instructions.)
2. Select your product.

Note: In certain programs, you may need to select your product as the "source" first. If you see a **Select Source** option, choose it and select your product. With Windows, do not select a **WIA** option for your product; it will not work correctly.

You see an Epson Scan window like this:

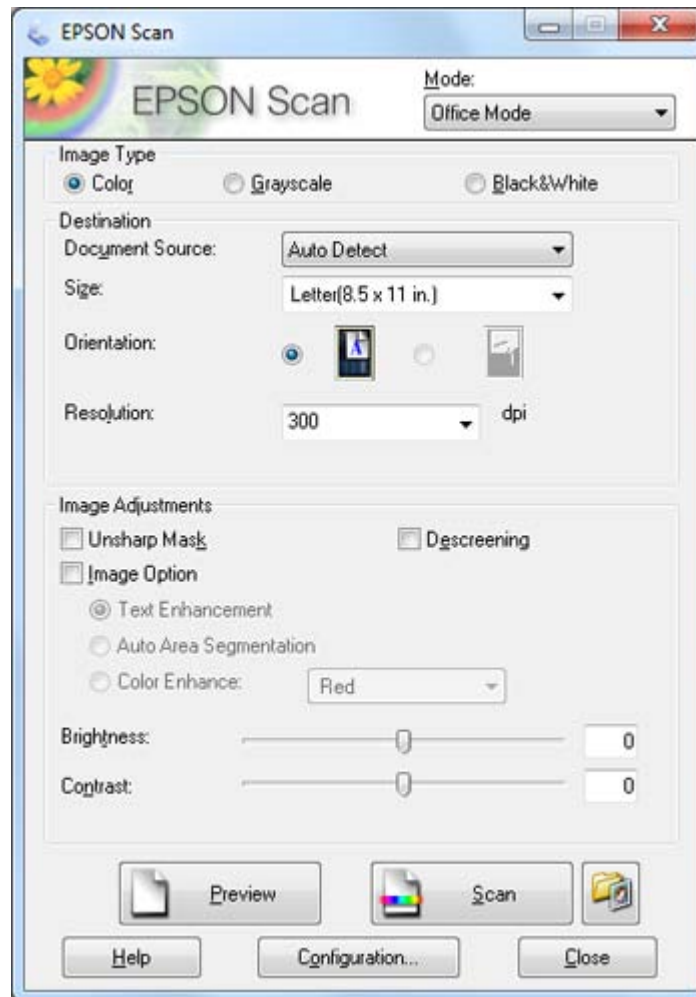

Parent topic: [Starting a Scan](#)

Related tasks

[Scanning with Mac OS X 10.6/10.7/10.8 Using Image Capture](#)

Related topics

[Selecting Epson Scan Settings](#)

Selecting Epson Scan Settings

After starting Epson Scan, you can select settings in various modes to customize your scan.

[Scan Modes](#)

[Selecting the Scan Mode](#)

[Scanning in Office Mode](#)

[Scanning in Home Mode](#)

[Scanning in Professional Mode](#)

[Image Preview Guidelines](#)

[Scan Resolution Guidelines](#)

[Selecting Scan File Settings](#)

Parent topic: [Scanning](#)

Scan Modes

Epson Scan provides a choice of scan modes with different levels of control over your settings.

Office Mode

You can quickly scan text documents and adjust them on a preview screen. You can also select various image adjustment options and preview your scanned image.

Home Mode

You can select setting groups based on the type of content you are scanning. You can also select various image adjustment options, and preview and size your scanned image.

Professional Mode

You can manually customize all available settings, and preview and size your scanned image.

Parent topic: [Selecting Epson Scan Settings](#)

Related tasks

[Selecting the Scan Mode](#)

Selecting the Scan Mode

Select the Epson Scan mode you want to use from the Mode box in the upper right corner of the Epson Scan window:



Parent topic: [Selecting Epson Scan Settings](#)

Related tasks

[Scanning in Home Mode](#)

[Scanning in Office Mode](#)

[Scanning in Professional Mode](#)

Scanning in Office Mode

When you scan in Office Mode, Epson Scan automatically saves your scanned file in JPEG format in your operating system's Pictures or My Pictures folder, or opens it in your scanning program. You can select settings, preview, and change the scanned file settings as necessary.

1. Start Epson Scan and select **Office Mode** as the Mode setting.

You see this window:

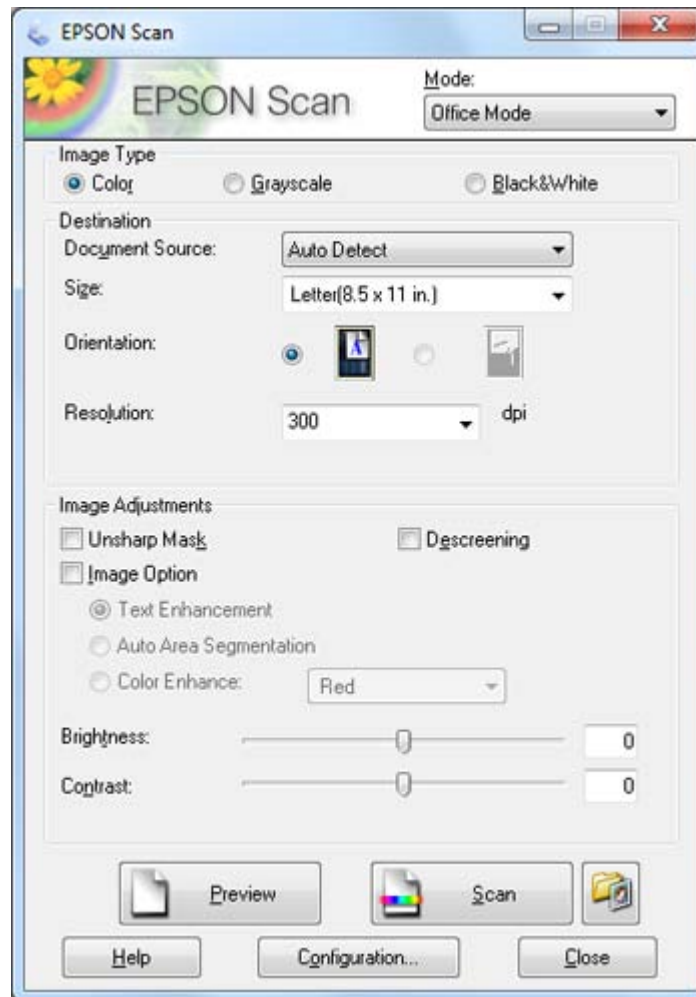

2. Select the **Image Type** setting that matches your original.
3. Select the **Document Source** setting indicating where you placed your original.
Note: If you are using the ADF, remove any documents from the scanner glass.
4. Select the **Size** and **Orientation** settings that match your original.

5. Select the **Resolution** setting you want to use for your scan.
6. Click the **Preview** button.
Epson Scan previews your original and displays the result in a separate Preview window.
7. If you are using the ADF, reinsert your original into the ADF.
8. If desired, select the area in your preview image that you want to scan (scanned image area).
9. Select any of the image adjustment settings you want to use. Before making adjustments, click the image or scanned image area in the Preview window.
10. Click **Scan**.
You see the File Save Settings window.
11. Change any of the necessary file save settings and click **OK**.

Epson Scan scans your original, and saves the file in the selected folder or opens it in your scanning program. If the file was saved directly to your computer, you see the file in the Windows Explorer or Mac OS X Finder, where you can view and print the image, if desired.

[Available Document Source Settings - Office Mode](#)

[Selecting a Scan Area - Office Mode](#)

[Available Image Adjustments - Office Mode](#)

Parent topic: [Selecting Epson Scan Settings](#)

Related concepts

[Scan Resolution Guidelines](#)

Related tasks

[Selecting Scan File Settings](#)

Available Document Source Settings - Office Mode

You can select these Document Source options in Epson Scan Office Mode.

Auto Detect

Automatically detects where the originals are placed on your product for scanning.

ADF

Selects the Automatic Document Feeder as the location where the originals are placed on your product for scanning.

Document Table

Selects the scanner glass as the location where the originals are placed on your product for scanning.

Parent topic: [Scanning in Office Mode](#)

Selecting a Scan Area - Office Mode

You can select a specific area in your preview image to include in your scanned image. You can select the entire image area or a portion of it. You can even select multiple scan areas to create multiple scanned images of different areas.

You can also use the scan area to select specific Image Adjustments settings for a scanned image. Just be sure to click inside the scan area before selecting the settings.

1. In the Preview window, click the  Auto Locate icon to create a marquee (dotted line) on the preview image.

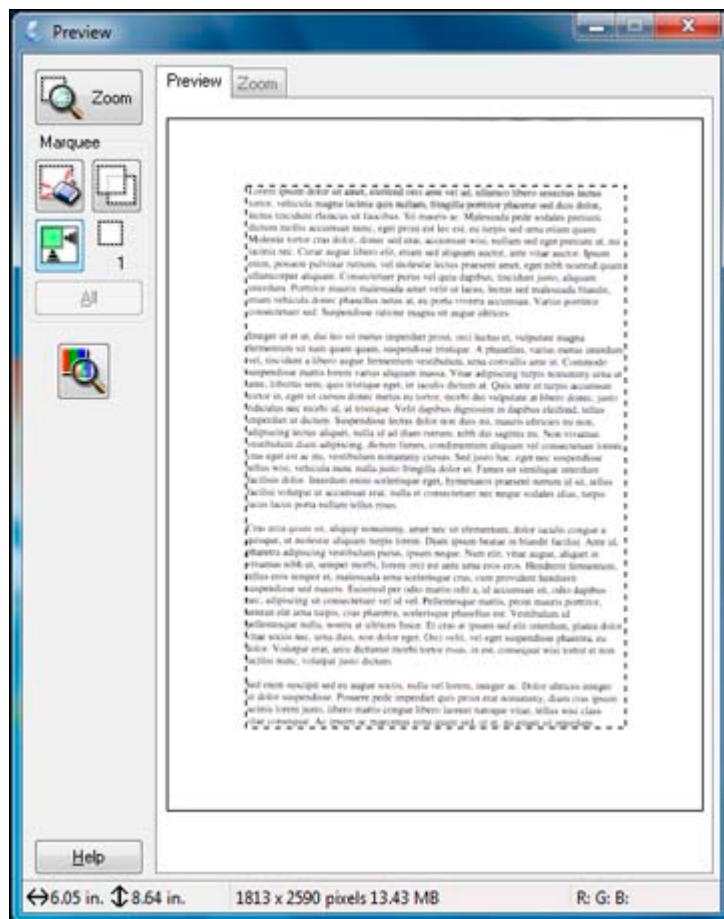

2. Do the following, as necessary, to work with the selected scan area:
 - If the marquee is correct, continue with the next step.
 - To move the marquee, click inside the scan area and drag the marquee where you want it.
 - To resize the scan area, place your cursor over the edge or corner of the marquee, then click and drag the edges where you want them. (Hold down the **Shift** key as you resize the marquee to retain the same width/height proportions.)
 - To create additional marquees (up to 50, if available), click the  Copy Marquee icon to copy the existing marquee and paste it on the preview image.

Note: If you draw multiple marquees, make sure you select the **All** button in the Preview window before you scan. Otherwise, only the area inside the currently selected marquee will be scanned.
 - To delete a marquee, click the marquee, then click the  Delete Marquee icon.
3. Click inside each scan area and make any necessary settings in the Epson Scan window.

Parent topic: [Scanning in Office Mode](#)

Available Image Adjustments - Office Mode

You can select these Image Adjustments options in Epson Scan Office Mode.

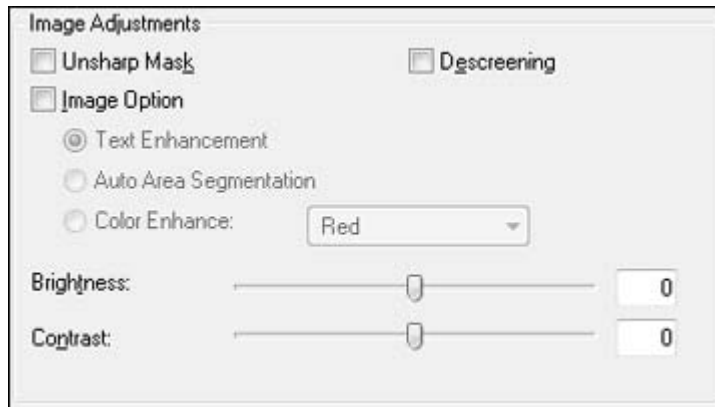

Note: Select the **Image Option** checkbox if you need to set any of the grayed-out image adjustments. Not all adjustment settings may be available, depending on the Image Type setting.

Unsharp Mask

Makes the edges of certain image areas clearer. Turn off this option to leave softer edges.

Descreening

Removes the ripple pattern that might appear in subtly shaded image areas, such as skin tones. This option improves results when scanning magazines or newspapers. (The results of descreening do not appear in the preview image, only in your scanned image.)

Text Enhancement

Sharpens the appearance of letters in text documents.

Auto Area Segmentation

Makes grayscale images clearer and text recognition more accurate by separating the text from the graphics.

Color Enhance

Enhances the red, green, or blue shades in the scanned image.

Brightness

Adjusts the overall lightness and darkness of the scanned image.

Contrast

Adjusts the difference between the light and dark areas of the overall scanned image.

Threshold

Adjusts the level at which black areas in text and line art are delineated, improving text recognition in OCR (Optical Character Recognition) programs.

Parent topic: [Scanning in Office Mode](#)

Scanning in Home Mode

When you scan in Home Mode, Epson Scan automatically saves your scanned file in JPEG format in your operating system's Pictures or My Pictures folder, or opens it in your scanning program. You can select settings, preview, and change the scanned file settings as necessary.

Note: You must place your original on the scanner glass when using **Home Mode**.

1. Start Epson Scan and select **Home Mode** as the Mode setting.

You see this window:

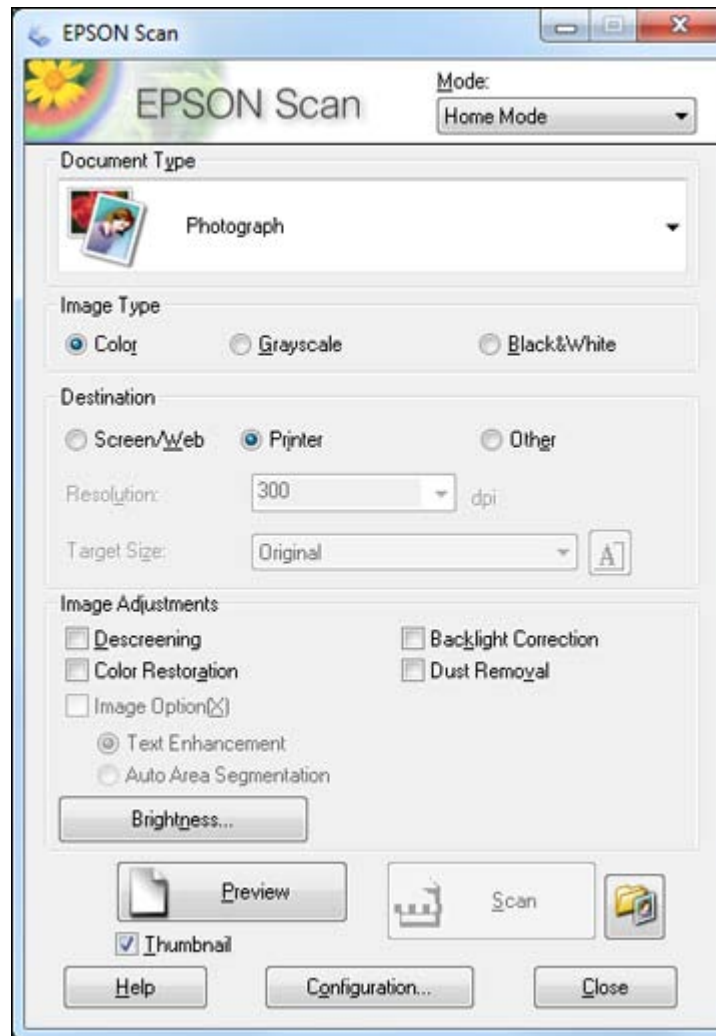

2. Select the **Document Type** setting that matches your original, such as **Photograph** or **Text/Line Art**.
3. Select the **Image Type** setting that matches your original.

4. Select the way you plan to use your scanned image as the **Destination** setting. (The Resolution setting is selected automatically based on the Destination setting you choose.)
 - **Screen/Web**: Select this option for images you will e-mail, view on a computer screen, or post on the web.
 - **Printer**: Select this option for images you will print or documents you will convert to editable text using OCR (Optical Character Recognition) software.
 - **Other**: Select this option if you want to select a custom resolution for your image.
5. If you selected **Other** in the last step, select the **Resolution** setting you want to use for your scan.
6. Click the **Preview** button.

Epson Scan previews your original and displays the result in a separate Preview window.
7. If desired, select the area in your preview image that you want to scan (scan area).
8. Select any of the image adjustment settings you want to use. Before making adjustments, click the image or scan area in the Preview window.
9. If you want to reduce or enlarge your image as you scan, select the **Target Size** setting you want to use.
10. Click **Scan**.

You see the File Save Settings window.
11. Change any of the necessary file save settings and click **OK**.

Epson Scan scans your original, and saves the file in the selected folder or opens it in your scanning program. If the file was saved directly to your computer, you see the file in the Windows Explorer or Mac OS X Finder, where you can view and print the image, if desired.

[Selecting a Scan Area - Home Mode](#)

[Available Image Adjustments - Home Mode](#)

[Selecting a Scan Size - Home Mode](#)

Parent topic: [Selecting Epson Scan Settings](#)

Related concepts

[Image Preview Guidelines](#)

[Scan Resolution Guidelines](#)

Related tasks

[Selecting Scan File Settings](#)

Selecting a Scan Area - Home Mode

You can select a specific area in your preview image to include in your scanned image. You can select the entire image area or a portion of it. You can even select multiple scan areas to create multiple scanned images of different areas (Normal Preview mode only).

You can also use the scan area to select specific Image Adjustments settings for a scanned image. Just be sure to click inside the scan area before selecting the settings.

1. Do one of the following to select your scan area in the Preview image:
 - **Thumbnail preview:** Your scan area is selected automatically, but you can change it. Place your cursor in one corner of the desired scan area, then click and drag the cursor to the opposite corner to create a marquee (dotted line) on the preview image.

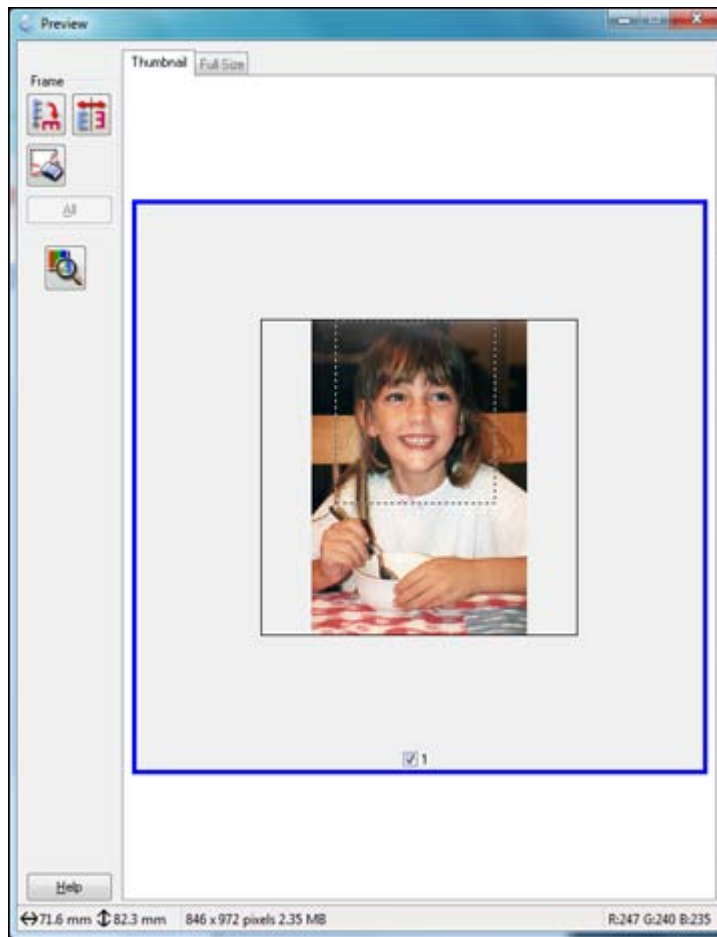

- **Normal preview:** Click the  Auto Locate icon to create a marquee (dotted line) on the preview image.

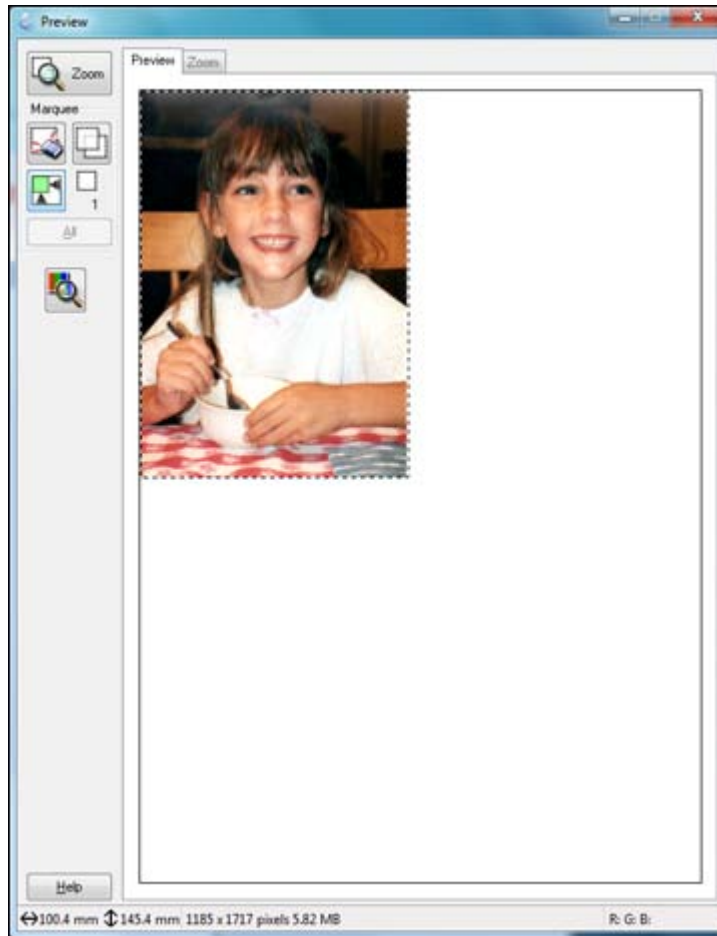

2. Do the following, as necessary, to work with the selected scan area:
 - If the marquee is correct, continue with the next step.
 - To move the marquee, click inside the scan area and drag the marquee where you want it.
 - To resize the scan area, place your cursor over the edge or corner of the marquee, then click and drag the edges where you want them. (Hold down the **Shift** key as you resize the marquee to retain the same width/height proportions.)

- **Normal preview:** To create additional marquees (up to 50), click the  Copy Marquee icon to copy the existing marquee and paste it on the preview image.

Note: If you draw multiple marquees, make sure you select the **All** button in the Preview window before you scan. Otherwise, only the area inside the currently selected marquee will be scanned.

- To delete a marquee, click the marquee, then click the  Delete Marquee icon.
3. Click inside the scan area and make any necessary settings in the Epson Scan window.

Parent topic: [Scanning in Home Mode](#)

Available Image Adjustments - Home Mode

You can select these Image Adjustments options in Epson Scan Home Mode.

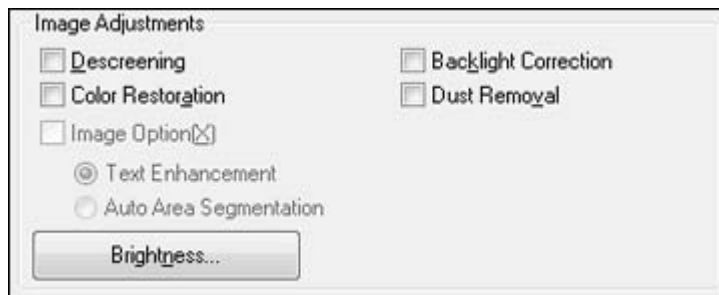

Note: Select the **Image Option** checkbox if you need to set any of the grayed-out image adjustments. Not all adjustment settings may be available, depending on the Document Type and Image Type setting. Click the **Brightness** button to access additional settings.

Descreening

Removes the ripple pattern that might appear in subtly shaded image areas, such as skin tones. This option improves results when scanning magazines or newspapers. (The results of descreening do not appear in the preview image, only in your scanned image.)

Color Restoration

Restores the colors in faded photos automatically.

Backlight Correction

Removes shadows from photos that have too much background light.

Dust Removal

Removes dust marks from your originals automatically.

Text Enhancement

Sharpens the appearance of letters in text documents.

Auto Area Segmentation

Makes grayscale images clearer and text recognition more accurate by separating the text from the graphics.

Brightness

Adjusts the overall lightness and darkness of the scanned image.

Contrast

Adjusts the difference between the light and dark areas of the overall scanned image.

Threshold

Adjusts the level at which black areas in text and line art are delineated, improving text recognition in OCR (Optical Character Recognition) programs.

Parent topic: [Scanning in Home Mode](#)

Selecting a Scan Size - Home Mode

You can reduce or enlarge the size of your image as you scan. You can also select a specific scan size, such as a common photo size like 4 × 6 inches (102 × 152 mm). This places a scan area of that size on the preview image so you can use it to help crop the image in the correct proportions.

1. Click the **Preview** button to preview your image.
2. In the Epson Scan window, select the size you want your scanned image to be from the **Target Size** list.



Note: If you need to rotate the orientation of the target size for your image, click the  Orientation icon.

A marquee (dotted line) appears on your preview image proportioned for the size you selected.

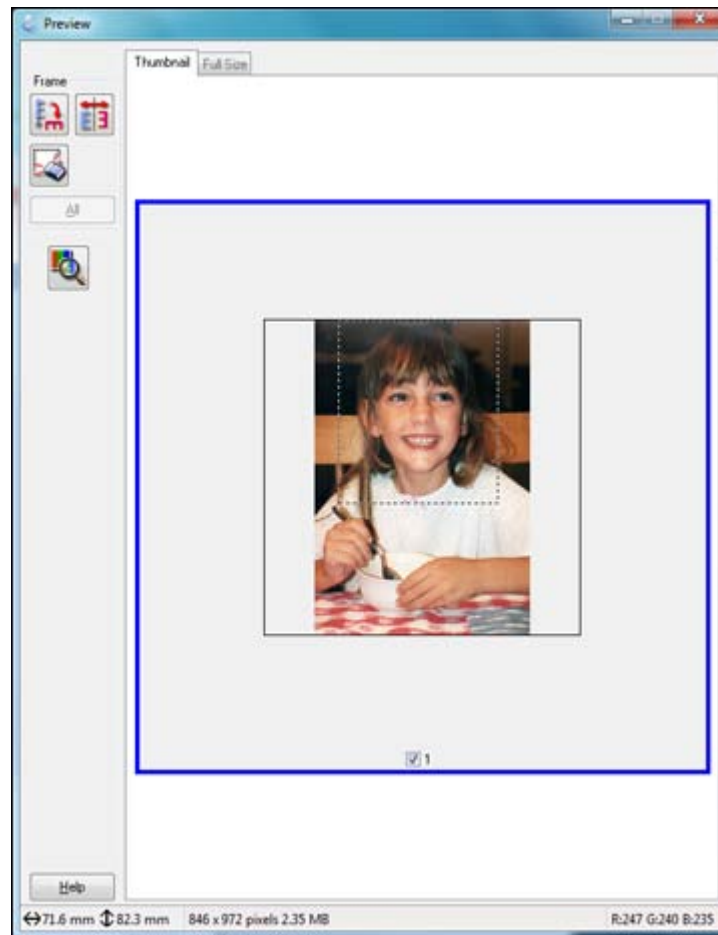

3. Do the following, as necessary, to work with the selected scan area:
 - To move the marquee, click inside the scan area and drag the marquee where you want it.
 - To resize the scan area, place your cursor over the edge or corner of the marquee, then click and drag the edge where you want it.

Note: Manually adjusting the marquee will not change the size of the scanned file. The marquee only indicates the area of the image that will be scanned.

4. To create a scanned image size that is not available in the Target Size list, click the **Customize** option.

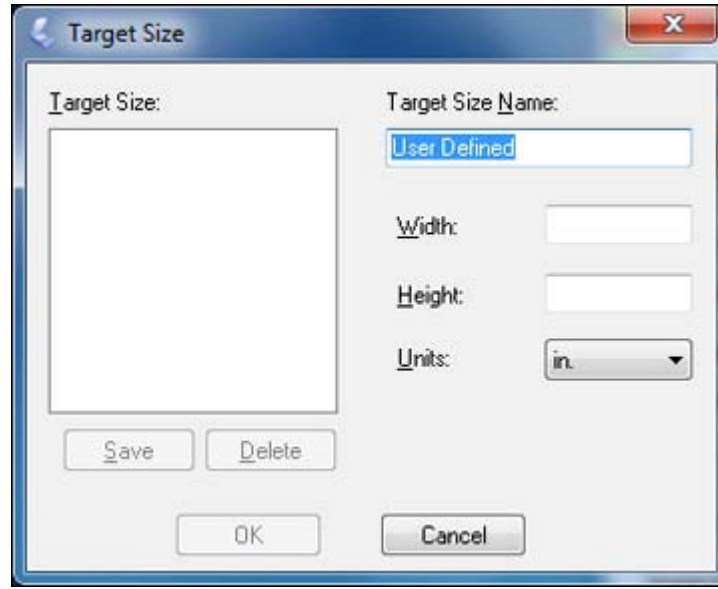

5. Name the custom size, enter the size, click **Save**, and click **OK**. Then create a scan area on the preview image.

The marquee is automatically proportioned for your custom scan size.

Parent topic: [Scanning in Home Mode](#)

Scanning in Professional Mode

When you scan in Professional Mode, Epson Scan automatically saves your scanned file in JPEG format in your operating system's Pictures or My Pictures folder, or opens it in your scanning program. You can select settings, preview, and change the scanned file settings as necessary.

1. Start Epson Scan and select **Professional Mode** as the Mode setting.

You see this window:

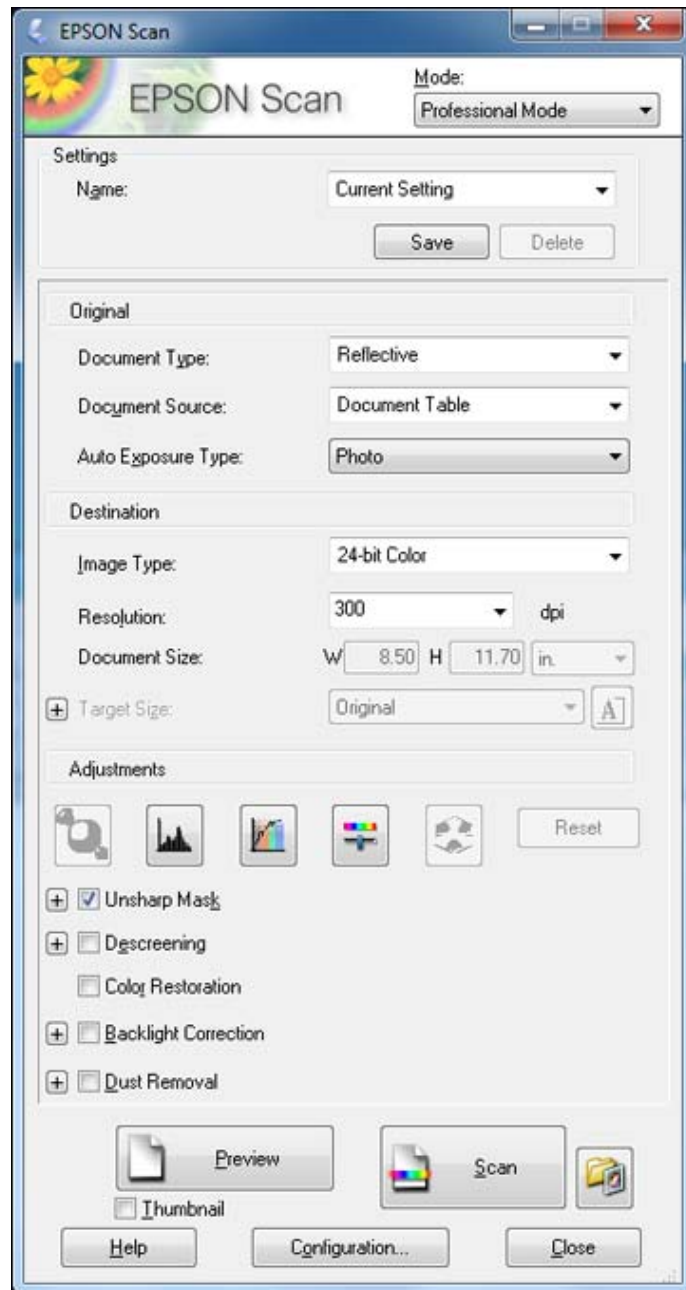

2. Select the **Document Type** setting that matches your original, such as **Reflective** for documents or photos.
3. Select the **Document Source** setting indicating where you placed your original.

Note: If you are using the ADF, remove any documents from the scanner glass.

4. Select the specific type of original you are scanning as the **Auto Exposure Type** setting: **Document** or **Photo**.
5. Select the details of your original and how you want it scanned as the **Image Type** setting.
6. Select the **Resolution** setting you want to use for your scan.
7. Click the **Preview** button.

Epson Scan previews your original and displays the result in a separate Preview window.

8. If you are using the ADF, reinsert your original into the ADF.
9. If desired, select the area in your preview image that you want to scan (scan area).
10. Select any of the image adjustment settings you want to use. Before making adjustments, click the image or scanned image area in the Preview window.
11. If you want to reduce or enlarge your image as you scan, select the **Target Size** setting you want to use.
12. Click **Scan**.

You see the File Save Settings window.

13. Change any of the necessary file save settings and click **OK**.

Epson Scan scans your original, and saves the file in the selected folder or opens it in your scanning program. If the file was saved directly to your computer, you see the file in the Windows Explorer or Mac OS X Finder, where you can view and print the image, if desired.

[Available Document Source Settings - Professional Mode](#)

[Available Image Types - Professional Mode](#)

[Selecting a Scan Area - Professional Mode](#)

[Available Image Adjustments - Professional Mode](#)

[Selecting a Scan Size - Professional Mode](#)

Parent topic: [Selecting Epson Scan Settings](#)

Related concepts

[Image Preview Guidelines](#)

[Scan Resolution Guidelines](#)

Related tasks

[Selecting Scan File Settings](#)

Available Document Source Settings - Professional Mode

You can select these Document Source options in Epson Scan Professional Mode.

ADF

Selects the Automatic Document Feeder as the location where the originals are placed on your product for scanning.

Document Table

Selects the scanner glass as the location where the originals are placed on your product for scanning.

Parent topic: [Scanning in Professional Mode](#)

Available Image Types - Professional Mode

You can select these Image Type options in Epson Scan Professional Mode.

24-bit Color

Select this setting for color photos.

Color Smoothing

Select this setting for color graphic images, such as charts or graphs.

8-bit Grayscale

Select this setting for black-and-white photos.

Black & White

Select this setting for black text documents or line art.

Parent topic: [Scanning in Professional Mode](#)

Selecting a Scan Area - Professional Mode

You can select a specific area in your preview image to include in your scanned image. You can select the entire image area or a portion of it. You can even select multiple scan areas to create multiple scanned images of different areas (Normal Preview mode only).

You can also use the scan area to select specific Image Adjustments settings for a scanned image. Just be sure to click inside the scan area before selecting the settings.

Note: In Professional Mode, the default Preview mode is Normal mode. To use Thumbnail Preview mode instead, select the **Thumbnail** checkbox beneath the Preview button (if available), then click the **Preview** button to preview your image again.

1. Do one of the following to select your scan area in the Preview image:

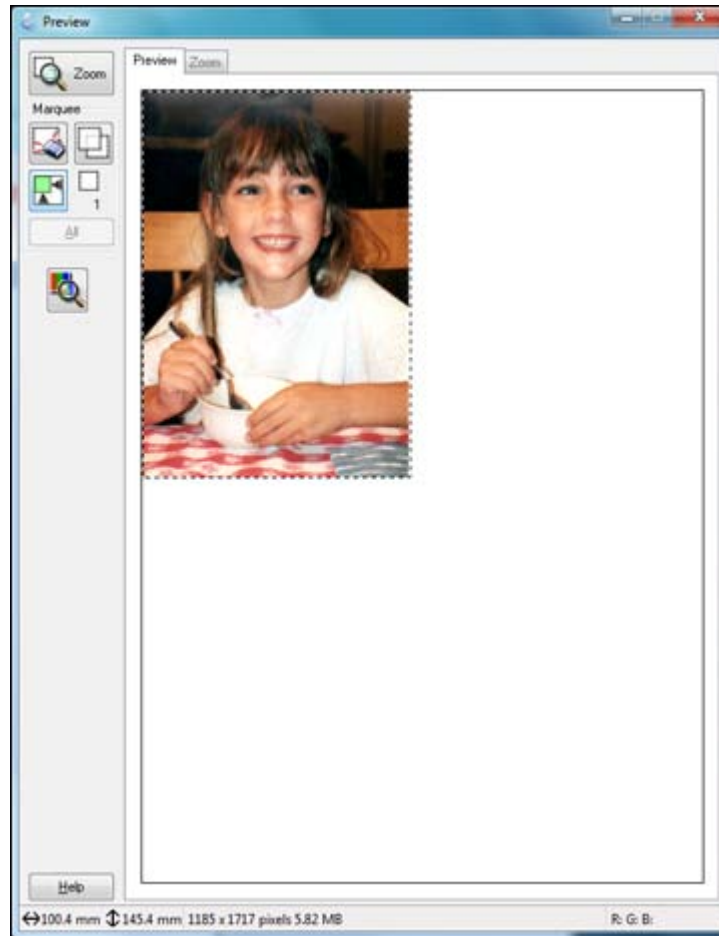

- **Normal preview:** Click the  Auto Locate icon to create a marquee (dotted line) on the preview image.

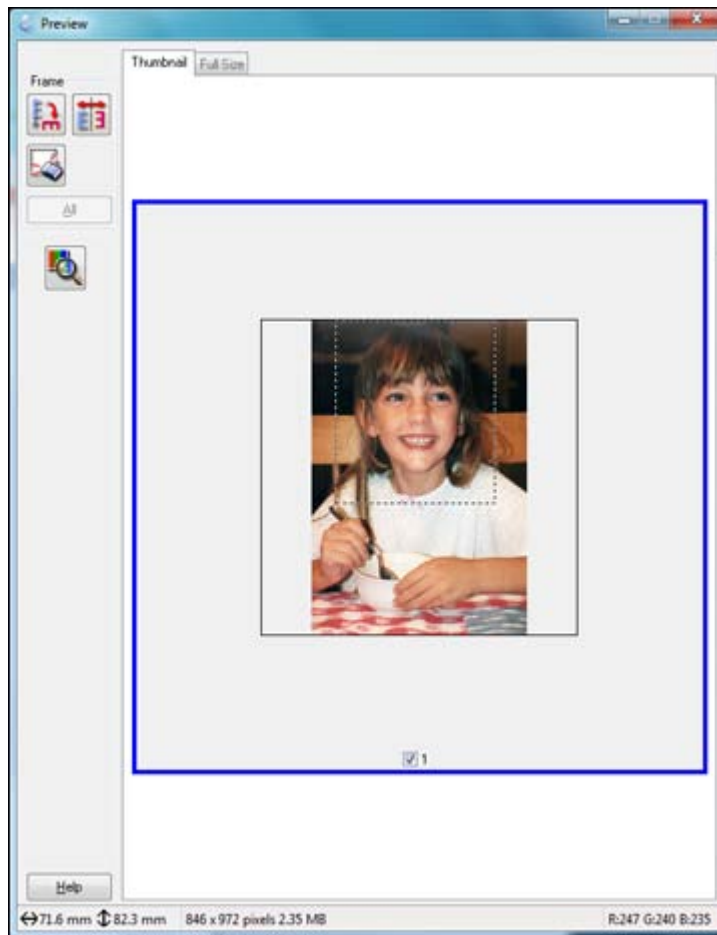

- **Thumbnail preview:** Your scan area is selected automatically, but you can change it. Place your cursor in one corner of the desired scan area, then click and drag the cursor to the opposite corner to create a marquee (dotted line) on the preview image.



2. Do the following, as necessary, to work with the selected scan area:
 - If the marquee is correct, continue with the next step.
 - To move the marquee, click inside the scan area and drag the marquee where you want it.
 - To resize the scan area, place your cursor over the edge or corner of the marquee, then click and drag the edges where you want them. (Hold down the **Shift** key as you resize the marquee to retain the same width/height proportions.)

- **Normal preview:** To create additional marquees (up to 50, if available), click the  Copy Marquee icon to copy the existing marquee and paste it on the preview image.
- To delete a marquee, click the marquee, then click the  Delete Marquee icon.

Note: If you draw multiple marquees, make sure you select the **All** button in the Preview window before you scan. Otherwise, only the area inside the currently selected marquee will be scanned.

3. Click inside the scan area and make any necessary settings in the Epson Scan window.

Parent topic: [Scanning in Professional Mode](#)

Available Image Adjustments - Professional Mode

You can select these Adjustments options in Epson Scan Professional Mode.

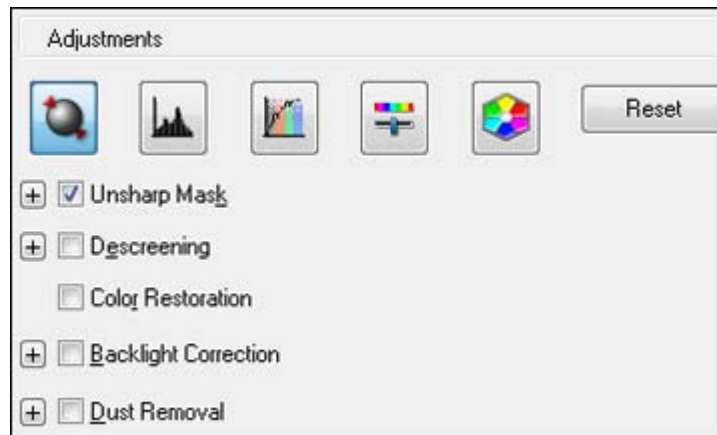

Note: Not all adjustment settings may be available, depending on the Image Type setting.

Click the  image adjustment icon to access additional settings.

Click the + (Windows) or ► (Mac OS X) icon next to a setting to change the level of adjustment.

Unsharp Mask

Makes the edges of certain image areas clearer. Turn off this option to leave softer edges.

Descreening

Removes the ripple pattern that might appear in subtly shaded image areas, such as skin tones. This option improves results when scanning magazines or newspapers. (The results of descreening do not appear in the preview image, only in your scanned image.)

Color Restoration

Restores the colors in faded photos automatically.

Backlight Correction

Removes shadows from photos that have too much background light.

Dust Removal

Removes dust marks from your originals automatically.

Auto Exposure

Automatically adjusts the image exposure settings when you click the  Auto Exposure icon. To automatically adjust image exposure settings continuously, click the **Configuration** button, click the **Color** tab, and select **Continuous auto exposure**. You can adjust the level of auto exposure using a slider.

Histogram Adjustment

Provides a graphical interface for adjusting highlight, shadow, and gamma levels individually. (For advanced users only.) Click the  histogram icon to access the settings.

Tone Correction

Provides a graphical interface for adjusting tone levels individually. (For advanced users only.) Click the  tone correction icon to access the settings.

Brightness

Adjusts the overall lightness and darkness of the scanned image.

Contrast

Adjusts the difference between the light and dark areas of the overall scanned image.

Saturation

Adjusts the density of colors in the overall image.

Color Balance

Adjusts the balance of colors in the overall image.

Color Palette

Provides a graphical interface for adjusting mid-tone levels, such as skin tones, without affecting the highlight and shadow areas of the image. (For advanced users only.) Click the  Color Palette icon to access the settings.

Threshold

Adjusts the level at which black areas in text and line art are delineated, improving text recognition in OCR (Optical Character Recognition) programs.

Parent topic: [Scanning in Professional Mode](#)

Selecting a Scan Size - Professional Mode

You can reduce or enlarge the size of your image as you scan. You can also select a specific scan size, such as a common photo size like 4 × 6 inches (102 × 152 mm). This places a scan area of that size on the preview image so you can use it to help crop the image in the correct proportions.

1. Click the **Preview** button to preview your image.
2. In the Epson Scan window, select the size you want your scanned image to be from the **Target Size** list.



Note: If you need to rotate the orientation of the target size for your image, click the  orientation icon.

A marquee (dotted line) appears on your preview image proportioned for the size you selected.

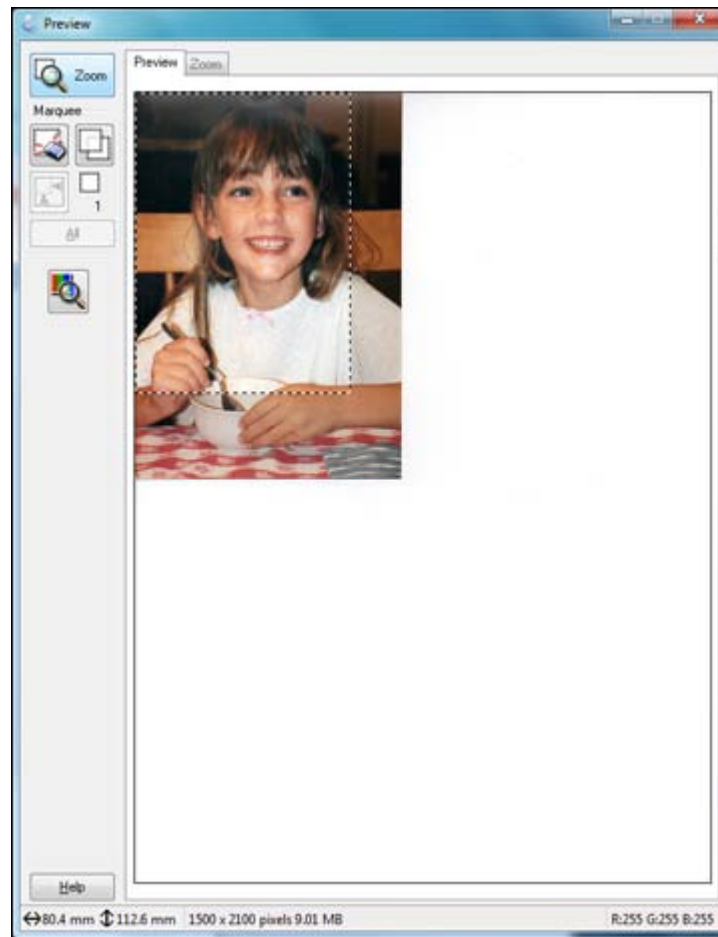

3. Do the following, as necessary, to work with the selected scan area:
 - To move the marquee, click inside the scan area and drag the marquee where you want it.
 - To resize the scan area, place your cursor over the edge or corner of the marquee, then click and drag the edge where you want it.

Note: Manually adjusting the marquee will not change the size of the scanned file. The marquee only indicates the area of the image that will be scanned.

- To create a scanned image size that is not available in the Target Size list, click the **Customize** option.

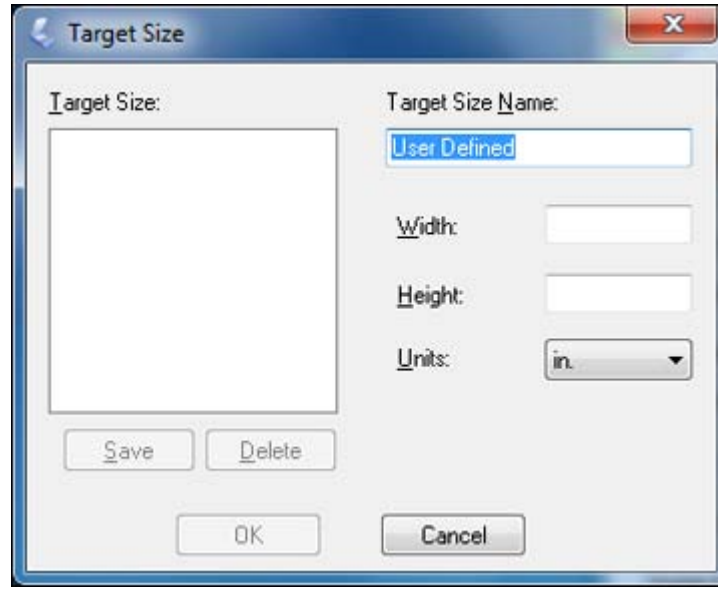

- Name the custom size, enter the size, click **Save**, and click **OK**. Then create a scan area on the preview image.
The marquee is automatically proportioned for your custom scan size.
- To use additional sizing tools, click the + (Windows) or ► (Mac OS X) icon next to the Target Size setting and select options as desired.



- Scale:** Reduces or enlarges your image by the percentage you enter.
- Trimming:** Turns automatic image cropping on or off.

-  Unlock icon: Unlocks the width/height proportions of the scanned image size so you can adjust it without constraint.

Parent topic: [Scanning in Professional Mode](#)

Image Preview Guidelines

You can preview your scanned image so you can adjust the scan settings using the preview as a guide. There are two types of preview available, depending on the scan mode and selected settings:

Thumbnail preview

A thumbnail preview displays your previewed images as thumbnails with the scanned image area and exposure automatically selected. If the **Thumbnail** checkbox is selected, clicking the **Preview** button opens a thumbnail preview.

Normal preview

A normal preview displays your previewed images in their entirety so you can select the scanned image area and other settings manually. If the **Thumbnail** checkbox is deselected, clicking the **Preview** button opens a normal preview.

Parent topic: [Selecting Epson Scan Settings](#)

Scan Resolution Guidelines

If you plan to enlarge a scanned image so you can print it at a larger size, you may need to increase the resolution from the default resolution set by Epson Scan. Follow these guidelines to determine the resolution setting you need:

- You will enlarge the image as you scan it.

If you will enlarge the image using Epson Scan's Target Size setting (Home and Professional modes only), you do not need to increase the Resolution setting.

- You will scan the image at its original size, but enlarge it later in an image-editing program.

Increase Epson Scan's Resolution setting in your scan. Increase the resolution by the same amount you will increase the image size to retain a high image quality. For example, if the resolution is 300 dpi (dots per inch) and you will double the image size later, change the Resolution setting to 600 dpi.

- You will scan the image at 100% or smaller size.

Select Epson Scan's Resolution setting based on how you will use the scanned image:

- E-mail/view on a computer screen/post on the web: 96 to 150 dpi
- Print/convert to editable text (OCR): 300 dpi
- Fax: 200 dpi

Parent topic: [Selecting Epson Scan Settings](#)

Selecting Scan File Settings

You can select the location, name, and format of your scan file on the File Save Settings window. You can also select various optional settings that control how Epson Scan behaves when you scan and save files.

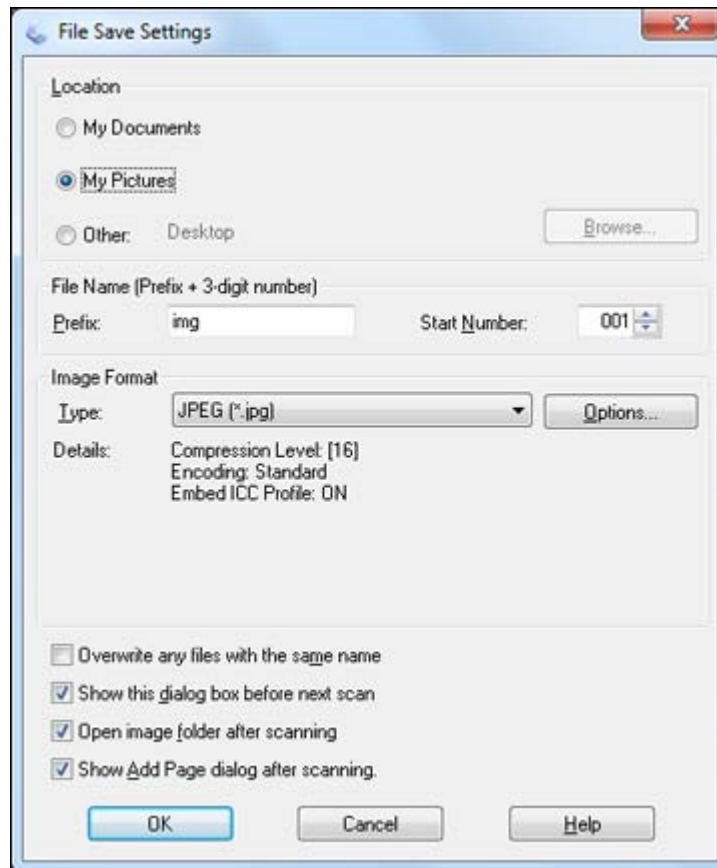

The File Save Settings window may appear after you click **Scan** on the Epson Scan window. You may also be able to access the window by clicking the  icon on the Epson Scan window.

1. Do one of the following to select the folder in which you want to save your scanned image:
 - Click the button for one of the displayed folders.
 - Click the **Other** button, click the **Browse** or **Choose** button, and select a folder.
2. Type in a stem file name in the **Prefix** field. This name is used along with numbers to automatically name your scanned files.
3. Select a different number as the **Start Number** setting, if you like.
4. Select the file format you want to use in the Image Format **Type** menu.
5. If your file format provides optional settings, click the **Options** button to select them.
6. Choose any of the optional settings you want to use by selecting their checkboxes.
7. Click **OK**.

[Available Scanned File Types and Optional Settings](#)

Parent topic: [Selecting Epson Scan Settings](#)

Available Scanned File Types and Optional Settings

You can select from a variety scanned file types and optional settings on the File Save Settings window in Epson Scan.

File Formats

Bitmap (*.bmp)

A standard image file format for most Windows programs.

JPEG (*.jpg)

An image format that lets you highly compress image data. However, the higher the compression, the lower the image quality. (The Tiff format is recommended when you need to modify or retouch your scanned image.)

Multi-TIFF (*.tif)

A Tiff file format when multiple pages are saved to the same file, allowing you to edit the images using a compatible program.

PDF (*.pdf)

A document format that is readable by Windows and Mac OS X systems using Adobe Reader, Acrobat, or other programs. You can save multi-page documents in one PDF file.

PICT (*.pct)

A standard image file format for most Mac OS X programs.

PRINT Image Matching II (*.jpg or *.tif)

File formats that include Epson PRINT Image Matching II data for enhanced quality and a wider color range (does not affect the way the image displays on the screen).

TIFF (*.tif)

A file format created for exchanging data between many programs, such as graphic and DTP software.

Optional Settings**Overwrite any files with the same name**

Select to overwrite previous files with the same names.

Show this dialog box before next scan

Select to have the File Save Settings window appear automatically before you scan.

Open image folder after scanning

Select to have Windows Explorer or Mac OS X Finder automatically open to the folder where your scanned image is saved after scanning.

Show Add Page dialog after scanning

If you are scanning a multi-page document using the PDF or Multi-Tiff format, select to display a prompt for scanning additional pages after the first page is scanned.

Parent topic: [Selecting Scan File Settings](#)

Scanning with Mac OS X 10.6/10.7/10.8 Using Image Capture

With Mac OS X 10.6/10.7/10.8, you can scan with your product using an image-editing application such as Image Capture.

Note: With Mac OS X 10.6, 10.7, or 10.8, in addition to scanning with Image Capture, you can download and install Epson Scan scanning software. Epson Scan provides additional image adjustment and photo correction features for enhancing scanned images, and provides an interface for TWAIN-compliant OCR scanning software, such as ABBYY FineReader. To download Epson Scan, visit Epson's driver download site ([U.S. downloads](#) or [Canadian downloads](#)).

1. Open an image editing application, such as Image Capture.
2. Select your Epson product from the **DEVICES** or **SHARED** list, if necessary.
3. If you see the **Show Details** button, click it.

If you are scanning an item on the scanner glass, your product begins a preview scan.

4. Select the **Scan Mode** setting indicating where you placed your original (if available). Select any other scan settings as necessary.

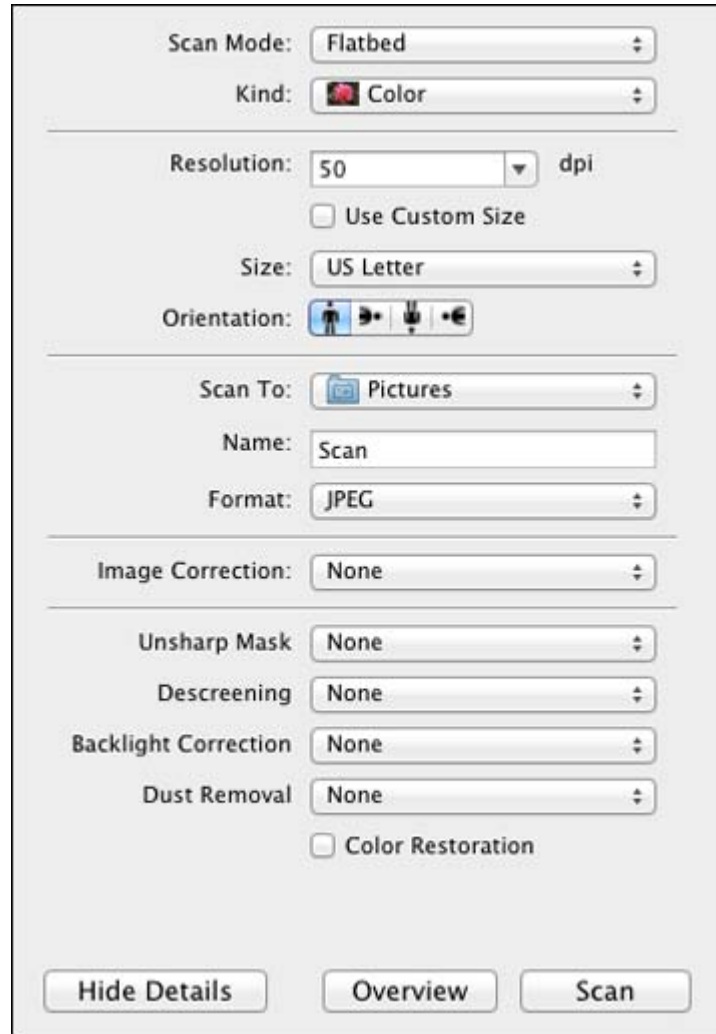

The image shows a scan settings dialog box with the following options:

- Scan Mode: Flatbed
- Kind: Color
- Resolution: 50 dpi
- Use Custom Size
- Size: US Letter
- Orientation: Portrait (indicated by a vertical document icon)
- Scan To: Pictures
- Name: Scan
- Format: JPEG
- Image Correction: None
- Unsharp Mask: None
- Descreening: None
- Backlight Correction: None
- Dust Removal: None
- Color Restoration

Buttons at the bottom: Hide Details, Overview, Scan

5. Select the folder in which you want to save your scanned file in the **Scan To** pop-up menu.
6. Click **Scan**.

Your scanned file is saved in the folder you selected.

[Available Scan Settings - Mac OS X Image Capture](#)

Parent topic: [Scanning](#)

Available Scan Settings - Mac OS X Image Capture

You can select these scan settings in your imaging editing application for Mac OS X.

Unsharp Mask

Makes the edges of certain image areas clearer. Turn off this option to leave softer edges.

Descreening

Removes the ripple pattern that might appear in subtly shaded image areas, such as skin tones. This option improves results when scanning magazines or newspapers. (The results of descreening do not appear in the preview image, only in your scanned image.)

Backlight Correction

Removes shadows from photos that have too much background light.

Dust Removal

Removes dust marks from your originals automatically.

Color Restoration

Restores the colors in faded photos automatically.

Parent topic: [Scanning with Mac OS X 10.6/10.7/10.8 Using Image Capture](#)

Scanning Special Projects

Your product's scanning software offers various options to help you quickly complete special scan projects.

[Scanning to a PDF File](#)

[Restoring Photo Colors as You Scan](#)

[Convert Scanned Documents to Editable Text \(OCR\)](#)

Parent topic: [Scanning](#)

Scanning to a PDF File

Using Epson Scan, you can scan a multi-page document and save it in one PDF (Portable Document Format) file on your computer.

1. Place your original on your product for scanning.
2. Start Epson Scan.

3. Select the scan mode you want to use.
4. Select the scan settings for your scan.
5. Preview your image.
6. When you finish selecting all your settings, click **Scan**.
You see the File Save Settings window.

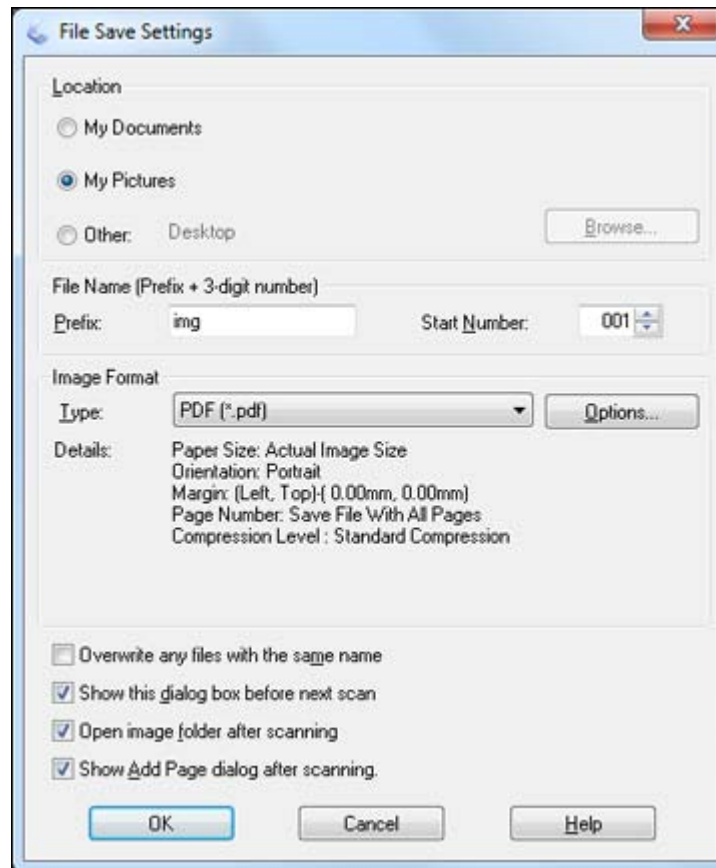

7. Select **PDF** as the Type setting.
8. Select any other settings you want to use on the File Save Settings window. Click the **Options** button to access additional settings.

9. Click **OK**.

Epson Scan scans your document and you see this window:

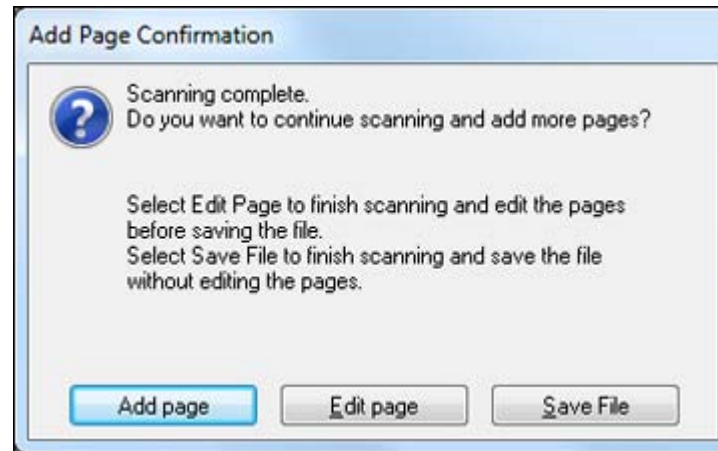

10. Choose one of the following options on the screen:

- If you are scanning only one page, click **Save File**.
- If you need to scan additional pages in a document, click **Add page**. Place additional pages on the product for scanning, click **Scan**, and repeat until you have scanned all the pages. When you are finished, click **Save File**.
- If you need to delete or reorder the scanned pages, click **Edit page**. Delete or reorder the pages using the icons that appear on the bottom of the editing window. When you are finished, click **OK**.

Note: If you installed an OCR (Optical Character Recognition) program, you may see a screen indicating the program is converting your page to text. Wait until the program re-scans the page and close the program, if necessary.

11. Click **Close** to exit the Epson Scan window, if necessary.

Epson Scan scans your original, and saves the PDF file in the selected folder or opens it in your scanning program. If the file was saved directly to your computer, you see the file in the Windows Explorer or Mac OS X Finder, where you can view and print the document, if desired.

Parent topic: [Scanning Special Projects](#)

Related tasks[Selecting the Scan Mode](#)[Selecting Scan File Settings](#)**Related topics**[Starting a Scan](#)[Selecting Epson Scan Settings](#)

Restoring Photo Colors as You Scan

You can restore the colors in faded photos as you scan them using Epson Scan's Color Restoration setting. You can select this setting in any of the available scan modes.

Note: Color restoration is not available in Office Mode, if Epson Scan offers that mode.

1. Place your original on your product for scanning.
2. Start Epson Scan.
3. Select the scan mode you want to use.
4. Select the scan settings for your scan.
5. Preview your image.
6. Locate or access the image adjustment settings.
7. Select the **Color Restoration** checkbox.



8. When you finish selecting all your settings, click **Scan**.
9. Click **Close** to exit the Epson Scan window, if necessary.

Epson Scan scans your original, and saves the color-restored file in the selected folder or opens it in your scanning program. If the file was saved directly to your computer, you see the file in the Windows Explorer or Mac OS X Finder, where you can view and print the image, if desired.

Parent topic: [Scanning Special Projects](#)

Related tasks[Selecting the Scan Mode](#)

Related topics

[Starting a Scan](#)

[Selecting Epson Scan Settings](#)

Convert Scanned Documents to Editable Text (OCR)

You can scan a document and convert the text into data that you can edit with a word processing, spreadsheet, or HTML-editing program. This process is called OCR (Optical Character Recognition).

To scan and use OCR, you need to install an OCR program, such as ABBYY FineReader.

In Mac OS X 10.6/10.7/10.8, you can use ABBYY FineReader to convert scanned documents to editable text by first using an application such as Image Capture. Scan and save your document in Image Capture, then open ABBYY FineReader, open the **Get Images From** pop-up menu, and select **File**. Select the conversion option you want to use, then select your scanned file and follow the instructions on the screen.

Note: With Mac OS X 10.6, 10.7, or 10.8, in addition to scanning with Image Capture, you can download and install Epson Scan scanning software. Epson Scan provides additional image adjustment and photo correction features for enhancing scanned images, and provides an interface for TWAIN-compliant OCR scanning software, such as ABBYY FineReader. To download Epson Scan, visit Epson's driver download site ([U.S. downloads](#) or [Canadian downloads](#)).

[Scanning Using OCR - Windows](#)

[Scanning Using OCR - Mac OS X](#)

Parent topic: [Scanning Special Projects](#)

Scanning Using OCR - Windows

You can use the ABBYY FineReader OCR program to convert scanned documents to editable text.

1. Place your original on your product for scanning.
2. Do one of the following to open ABBYY FineReader:
 - **Windows 8:** Navigate to the **Start** screen and select **ABBYY FineReader 9.0 Sprint**.
 - **Windows (other versions):** Click  or **Start > All Programs** or **Programs > ABBYY FineReader 9.0 Sprint > ABBYY FineReader 9.0 Sprint**.

You see this window:

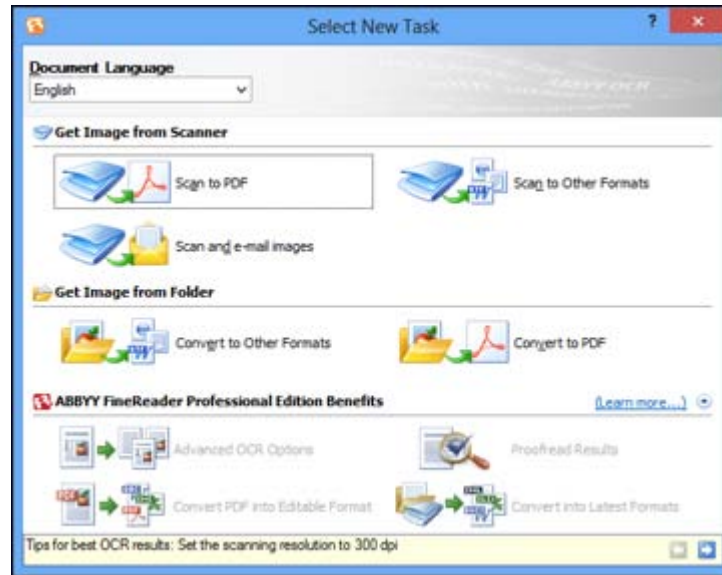

3. Select the language used in the document you are going to scan as the **Document Language** setting.
4. Click either the **Scan to Other Formats** icon or the icon that corresponds with the program you want to scan to.
5. If you see the Select Scanner window, select your product and click **OK**.

Note: Do not select a **WIA** option for your product; it will not work correctly.

You see the scan settings window.

6. Select your scan settings.
7. Click **Preview** and adjust the area you want to scan, if necessary.
8. Click **Scan**.

Note: To scan a multi-page document, select settings in the Multi-Page Scanning section and click **Scan** for each page.

9. When you are finished scanning, click **Close**.

Your document is scanned and processed into editable text, then you see the Save As window.

10. Select a name and a file format for your document and click **Save**.

The file is saved and then opened in an application associated with the file type you selected, if available on your system.

Parent topic: [Convert Scanned Documents to Editable Text \(OCR\)](#)

Scanning Using OCR - Mac OS X

You can use the ABBYY FineReader OCR program to convert scanned documents to editable text.

In Mac OS X 10.6/10.7/10.8, you can use ABBYY FineReader to convert scanned documents to editable text by first using an application such as Image Capture. Scan and save your document in Image Capture, then open ABBYY FineReader, open the **Get Images From** pop-up menu, and select **File**. Select the conversion option you want to use, then select your scanned file and follow the instructions on the screen.

Note: With Mac OS X 10.6, 10.7, or 10.8, in addition to scanning with Image Capture, you can download and install Epson Scan scanning software. Epson Scan provides additional image adjustment and photo correction features for enhancing scanned images, and provides an interface for TWAIN-compliant OCR scanning software, such as ABBYY FineReader. To download Epson Scan, visit Epson's driver download site ([U.S. downloads](#) or [Canadian downloads](#)).

1. Place your original on your product for scanning.
2. Open the **Applications** folder and click the **ABBYY FineReader Sprint** icon.

You see this window:



3. Open the **Get Images From** pop-up menu and select your product.
4. Select the language used in the document you are going to scan as the **Document Language** setting.
5. Select the type of document you are going to scan.
Epson Scan starts in the last scan mode you used.
6. Select your scan settings and click **Scan**.
Your document is scanned and you see the Epson Scan window while your document is converted to editable text.
7. Click **Close** to close the Epson Scan window and Preview window, if necessary.

You see the Save Converted File As window:

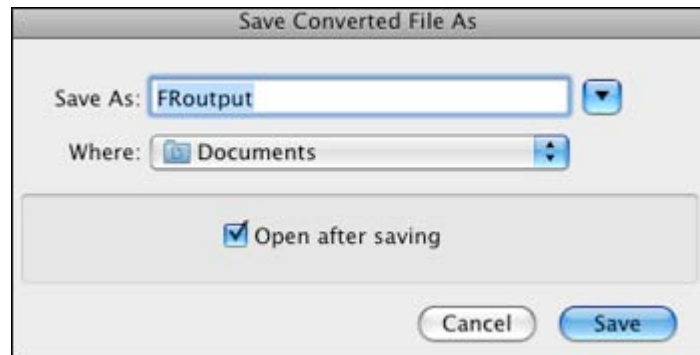

8. Click the **Save** button.

The file is saved and then opened in an application associated with the file type you selected, if available on your system.

Parent topic: [Convert Scanned Documents to Editable Text \(OCR\)](#)

Faxing

See these sections to fax using your product.

Note: This product allows you to store names, telephone numbers, and fax data in its memory even when the power is turned off. Make sure you restore all of the default settings if you give away or dispose of the product. This will erase all of your network settings and fax data.

[Connecting a Telephone or Answering Machine](#)

[Setting Up Fax Features](#)

[Setting Up Speed Dial and Group Dial Lists](#)

[Sending Faxes](#)

[Receiving Faxes](#)

Connecting a Telephone or Answering Machine

You must connect your product to a telephone wall jack to send or receive faxes. If you want to use the same telephone line to receive calls, you can connect a telephone or answering machine to your product using an additional phone cable.

Note: If you do not connect a telephone to your product, make sure to turn on Auto Answer mode. Otherwise, you cannot receive faxes.

1. Connect the phone cable to your telephone wall jack and to the **LINE** port on your product.

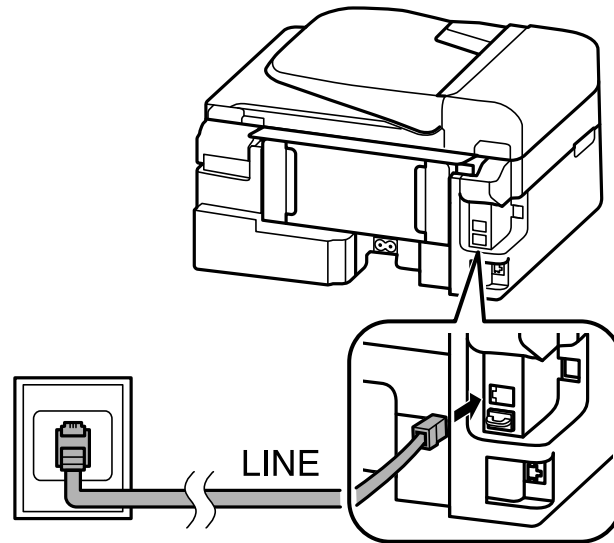

Note: If you have a DSL or ISDN connection, you must connect the appropriate DSL filter, or ISDN terminal adapter or router to the wall jack to be able to use the line for faxing or voice calls using your product. Contact your DSL or ISDN provider for the necessary equipment.

DSL connection

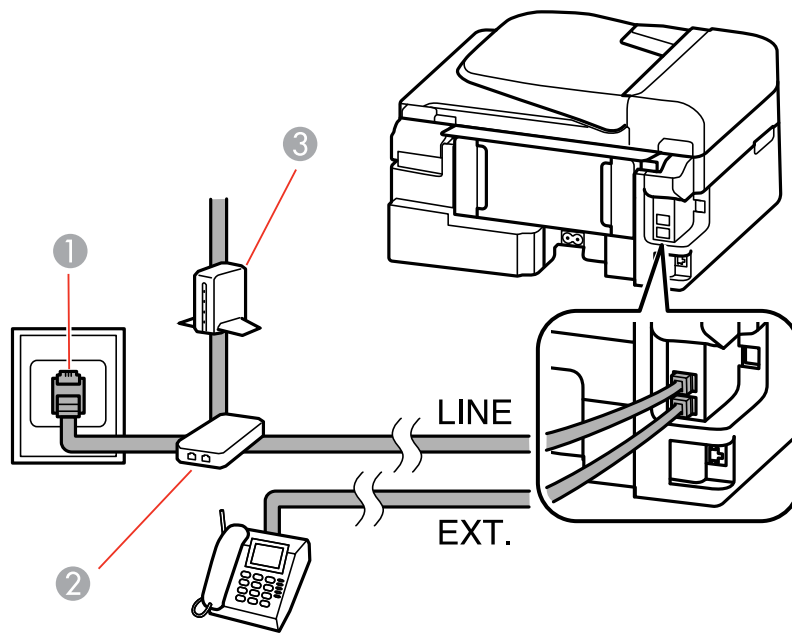

- 1 Telephone wall jack
- 2 DSL filter
- 3 DSL modem

ISDN connection (one phone number)

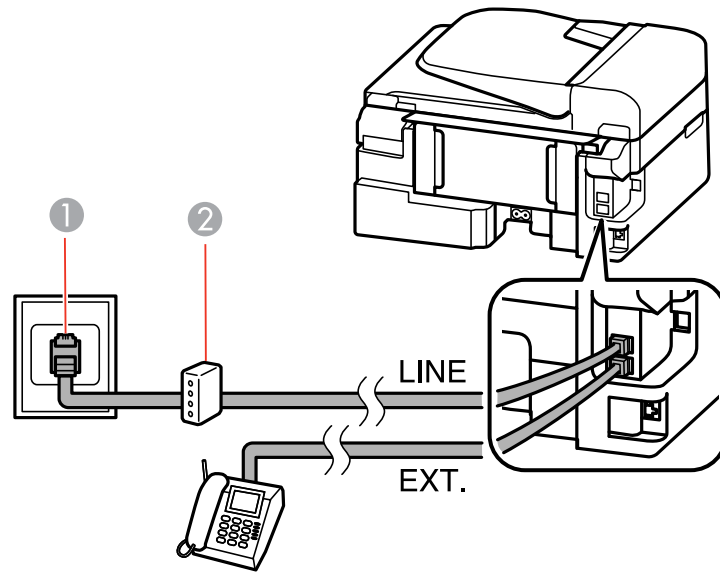

- 1 ISDN wall jack
- 2 Terminal adapter or ISDN router

ISDN connection (two phone numbers)

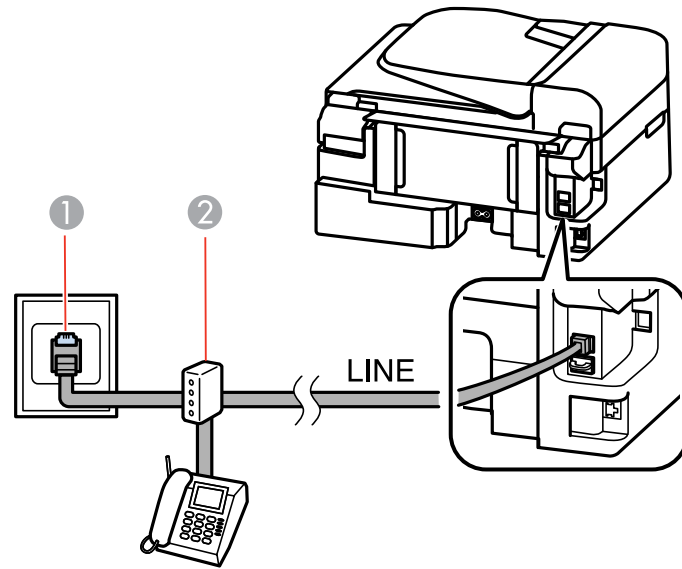

- 1 ISDN wall jack
- 2 Terminal adapter or ISDN router

2. If you are connecting a telephone or answering machine to your product using a second phone cable, remove the cap from the **EXT** port on your product.

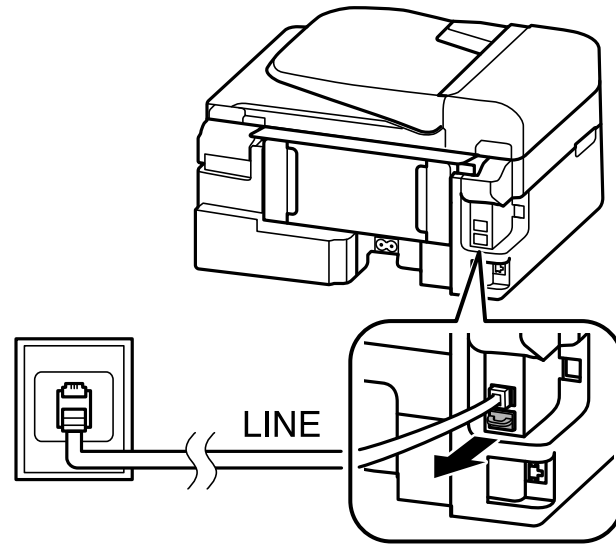

3. Connect the second phone cable to your telephone or answering machine and to the **EXT** port on your product.

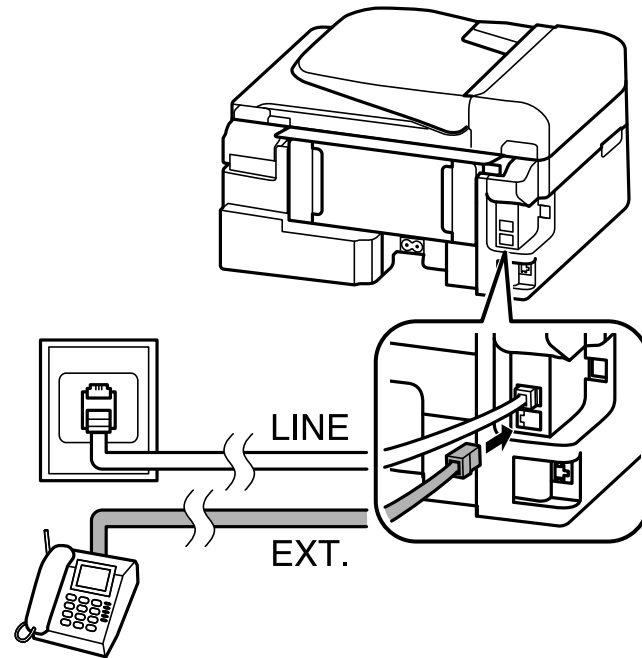

Note: If you connect an answering machine and Auto Answer mode is turned on, make sure the product's **Rings to Answer** setting is set higher than the number of rings your answering machine is set to answer a call.

Any phone or answering machine must be connected to the **EXT** port for your product to detect an incoming fax call when the phone is picked up. Epson cannot guarantee compatibility with VoIP, cable phone systems, or fiberoptic digital services such as FIOS.

Parent topic: [Faxing](#)

Related references

[Fax Receive Options](#)

[Fax Communications Options](#)

Setting Up Fax Features

Before faxing with your product, set up your fax header and select the fax features you want to use.

Note: If you leave your product unplugged for a long period of time, you may need to reset the date and time settings for faxes.

[Setting Up Fax Features Using the Product Control Panel](#)

[Setting Up Fax Features Using the Fax Utility - Windows](#)

[Setting Up Fax Features Using the Fax Utility - Mac OS X](#)

Parent topic: [Faxing](#)

Setting Up Fax Features Using the Product Control Panel

See these sections to set up fax features using the product control panel.

[Selecting Your Country or Region](#)

[Selecting the Date and Time](#)

[Entering Fax Header Information](#)

[Entering Numbers and Characters for Faxing](#)

[Selecting Fax Send and Receive Settings](#)

[Selecting Fax Communication Settings](#)

[Printing Fax Reports](#)

[Restoring Default Fax Settings](#)

[Fax Sending Options](#)

[Fax Receive Options](#)

[Fax Communications Options](#)

[Fax Report Options](#)

[Restore Default Settings Options](#)

Parent topic: [Setting Up Fax Features](#)

Selecting Your Country or Region

Before faxing, select the country or region in which you are using your product.

Note: If you change the country or region, your fax settings return to their defaults and you must select them again.

1. Press the  **Menu** button.
2. Press the up or down arrow buttons to select **Printer Setup** and press the **OK** button.

You see this screen:



3. Press the up or down arrow buttons to select **Country/Region** and press the **OK** button.
4. Press the up or down arrow buttons to select your country or region and press the **OK** button.
You see a confirmation screen.
5. If the setting is correct, select **Yes** and press the **OK** button. (If not, select **No** and retry.)

Note: Changing the country or region will restore the fax settings to the default settings.

Parent topic: [Setting Up Fax Features Using the Product Control Panel](#)

Selecting the Date and Time

Before faxing, select the current date, time, and daylight saving phase in your area, and choose your preferred date and time format.

1. Press the  **Menu** button.
2. Press the up or down arrow buttons to select **Printer Setup** and press the **OK** button.

You see this screen:



3. Press the up or down arrow buttons to select **Date/Time** and press the **OK** button.
You see this screen:

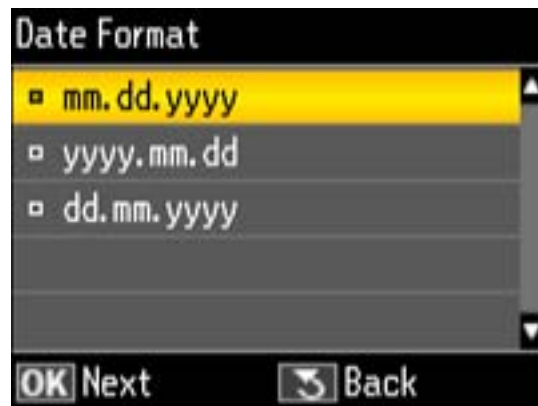

4. Press the up or down arrow buttons to select the date format you want to use and press the **OK** button.
5. Use the number buttons on the control panel to enter the current date, then press the **OK** button.
6. Press the up or down arrow buttons to select the time format you want to use and press the **OK** button.

7. Use the number buttons on the control panel to enter the current time, select **AM** or **PM** if you selected a 12-hour time format, then press the **OK** button.
8. Press the up or down arrow buttons to select **Daylight Saving Time** and press the **OK** button.
9. Press the up or down arrow buttons to select **Summer** if Daylight Saving Time (DST) is in effect; otherwise, select **Winter**. Then press the **OK** button.



Note: If your region uses Daylight Saving Time (DST), you must change this setting to match the season. When you change from **Winter** to **Summer**, your product automatically sets its clock ahead one hour. When you change from **Summer** to **Winter**, it sets the clock back one hour.

10. Press the  **Menu** button to exit.

Parent topic: [Setting Up Fax Features Using the Product Control Panel](#)

Entering Fax Header Information

Before faxing, add your sender name and fax number to the fax header to identify the source of the faxes you send.

1. Press the  **Fax** button.
2. Press the  **Menu** button.
3. Press the up or down arrow buttons to select **Fax Settings** and press the **OK** button.

You see this screen:

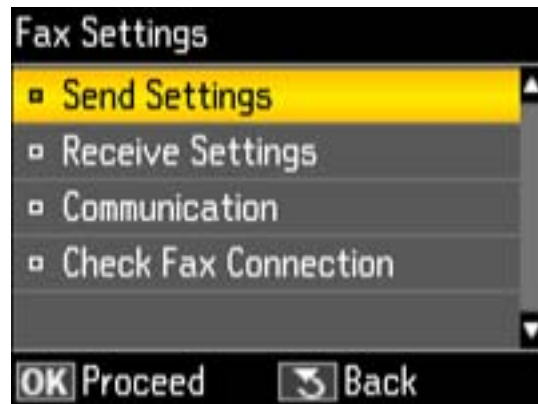

4. Press the up or down arrow buttons to select **Communication** and press the **OK** button.

5. Press the up or down arrow buttons to select **Header** and press the **OK** button.
6. Press the **OK** button to select **Fax Header**.

You see this screen:



7. Use the keypad to enter the sender name for your fax source, such as your name or a business name. You can enter up to 40 characters.
8. Select **Done** and press the **OK** button to return to the Header menu.
9. Press the up or down arrow buttons to select **Your Phone Number** and press the **OK** button.
10. Use the numeric buttons on the control panel to enter your fax number, up to 20 characters. You do not need to use dashes.
11. Press the **OK** button to return to the Header menu.
12. Press the  **Menu** button to exit.

Parent topic: [Setting Up Fax Features Using the Product Control Panel](#)

Related tasks

[Entering Numbers and Characters for Faxing](#)

Entering Numbers and Characters for Faxing

Follow these guidelines to enter numbers and characters for setting up your fax settings. You can use the LCD keypad described here or the numeric buttons on the product control panel.





- Press the arrow buttons to highlight a character or a function button displayed on the keypad. Then press the **OK** button to select it.
- To change the case of letters, select **AB12** (uppercase), **ab12** (lowercase) and press the **OK** button.
- To select a symbol, select **Symbol** and press the **OK** button. Then highlight a symbol and press the **OK** button to select it.
- To enter a space, select **Space** and press the **OK** button.
- To delete characters, select the back arrow and press the **OK** button.
- When you finish entering characters, select **Done** and press the **OK** button.

Parent topic: [Setting Up Fax Features Using the Product Control Panel](#)

Selecting Fax Send and Receive Settings

You can select the paper source, fax quality, and other settings for incoming and outgoing faxes.

1. Press the  **Fax** button.
2. Press the  **Menu** button.
3. Press the up or down arrow buttons to select **Fax Settings** and press the **OK** button.

You see this screen:

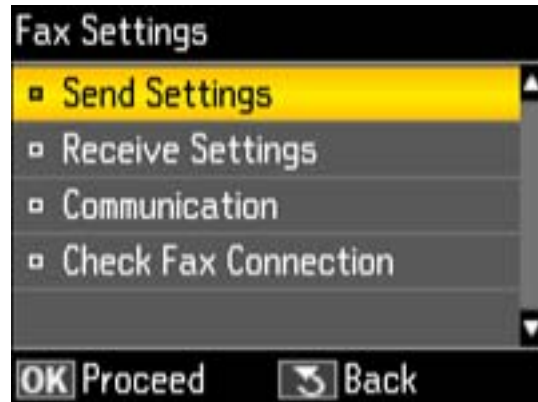

4. Press the up or down arrow buttons to select **Send Settings** or **Receive Settings** and press the **OK** button.
5. Press the up or down arrow buttons to change any of the available settings.
6. Press the  **Menu** button to exit.

Parent topic: [Setting Up Fax Features Using the Product Control Panel](#)



Related references

[Fax Sending Options](#)

[Fax Receive Options](#)

Selecting Fax Communication Settings

You can customize how your product sends and receives faxes over your phone line.

1. Press the  **Fax** button.
2. Press the  **Menu** button.
3. Press the up or down arrow buttons to select **Fax Settings** and press the **OK** button.

You see this screen:

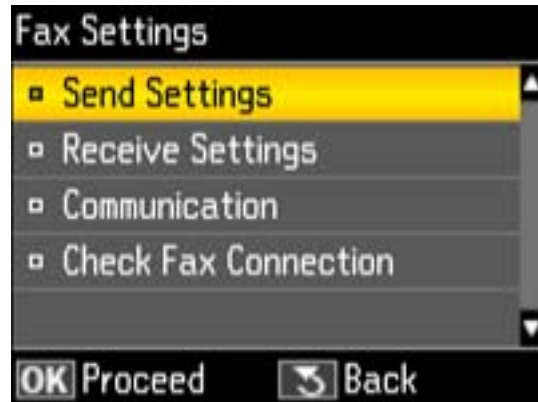

4. Press the up or down arrow buttons to select **Communication** and press the **OK** button.
5. Press the up or down arrow buttons to change any of the available settings.
6. Press the  **Menu** button to exit.

Parent topic: [Setting Up Fax Features Using the Product Control Panel](#)



Related references

[Fax Communications Options](#)

Printing Fax Reports

You can run a variety of reports on your fax transmissions and print your speed and group dial lists.

Note: You can also select to print a report automatically after a fax is sent by pressing the  **Fax** button, pressing the  **Menu** button, then selecting **Fax Settings > Send Settings > Last Transmission Report**.

1. Make sure you loaded letter-size or larger paper in your product.
2. Press the  **Fax** button.
3. Press the  **Menu** button.
4. Press the up or down arrow buttons to select **Fax Report** and press the **OK** button.

You see this screen:



5. Press the up or down arrow buttons to select one of the available reports and press the **OK** button.

Note: If you select **Fax Log**, additionally select **Print** and press the **OK** button.

6. Press one of the **Start** buttons to print the report.

Parent topic: [Setting Up Fax Features Using the Product Control Panel](#)

Related references

[Fax Report Options](#)

Restoring Default Fax Settings

You can restore your fax settings to their default options, if necessary.

1. Press the **Menu** button.
2. Press the up or down arrow buttons to select **Restore Default Settings** and press the **OK** button.

You see this screen:



3. Press the up or down arrow buttons to select one of the available options and press the **OK** button. You see a confirmation screen.
4. Select **Yes** or **No** and press the **OK** button.

Parent topic: [Setting Up Fax Features Using the Product Control Panel](#)

Related references

[Restore Default Settings Options](#)

Fax Sending Options

Set the options you want to use for outgoing faxes.

Setting	Options	Description
Quality	Standard	Provides good scan resolution and print quality for most faxes.
	Fine	Provides best scan resolution and print quality for faxes of small print and line art.
	Photo	Provides best scan resolution and print quality for faxed photos.
Contrast	-4 to +4	Adjusts the contrast for faxes; negative settings make faxes lighter and positive settings make faxes darker.

Setting	Options	Description
Last Transmission Report	On Error	Prints a report on the last transmitted fax only if a fax error occurs (default setting).
	On Send	Prints a report on the last transmitted fax after every fax you send.
	Off	Does not print a report on the last transmitted fax after you send a fax.

Parent topic: [Setting Up Fax Features Using the Product Control Panel](#)

Fax Receive Options

Set the printing options you want to use for incoming faxes.

Setting	Options	Description
Auto Answer	On	Sets the product to receive and print faxes automatically.
	Off	
Paper Size to Print	Letter	Sets the paper size for incoming faxes.
	Legal	
	A4	
Auto Reduction	On	Reduces size of incoming faxes to fit on the paper in the selected Paper Size to Print .
	Off	Prints incoming faxes in original size or on multiple sheets, if loaded paper size is smaller.

Parent topic: [Setting Up Fax Features Using the Product Control Panel](#)

Fax Communications Options

Set the communication options you want to use for faxing over your phone line.

Setting	Options	Description
DRD	All	If you are using a Distinctive Ring Service on your phone line, your telephone company can assign two or more phone numbers to the same line and assign different ring patterns to each. If you use this service, select the number of rings for your fax number as the DRD setting so your product can receive faxes on the correct number of rings. All is the default setting and works for phone lines that do not use this service.
	Single	
	Double	
	Triple	
	Double&Triple	
ECM	On	Turns on Error Correction Mode (ECM) to automatically request retransmission of faxes received with detected errors (default setting).
	Off	Turns off Error Correction Mode (ECM).
Fax Speed	Fast(33,600bps)	Transmits faxes at 33.6 Kbps (default setting)
	Medium(14,400bps)	Transmits faxes at 14.4 Kbps
	Slow(9,600bps)	Transmits faxes at 9.6 Kbps
Rings to Answer	1 to 9	Sets the number of rings before your product receives a fax. The default setting is 4 . If Auto Answer is turned on and an answering machine is connected to the product, make sure this setting is set higher than the number of rings your answering machine is set to answer a call.
Dial Tone Detection	On	Automatically dials the phone number you enter to send a fax when the product detects a dial tone on the line.
	Off	Turns off automatic dial tone detection. This is necessary if you connected your product to a phone line on a Private Branch Exchange (PBX) or Terminal Adapter (TA) system.
Header	Fax Header	Lets you set up the header information for outgoing faxes.
	Your Phone Number	

Parent topic: [Setting Up Fax Features Using the Product Control Panel](#)

Fax Report Options

Select the fax report or list you want to print.

Fax Log

View or print a report on recent fax transmissions.

Last Transmission

Print a report on your last fax transmission.

Speed Dial List

Print a list of your speed dial entries.

Group Dial List

Print a list of your group dial entries.

Reprint Faxes

Reprint the most recent incoming fax.

Protocol Trace

Print a protocol trace of your last fax transmission.

Parent topic: [Setting Up Fax Features Using the Product Control Panel](#)

Restore Default Settings Options

Select the product settings you want to restore.

Fax Send/Receive Settings

Restores all of the default fax settings on the **Send Settings**, **Receive Settings**, and **Communication** screens.

Fax Data Settings

Erases the speed dial list, group dial list, header, and fax log.

Wi-Fi/Network Setting

Restores all of the default network settings.

All except Wi-Fi/Network & Fax Settings

Restores all of the default settings on the control panel, except for the network and fax settings.

All Settings

Restores all of the default settings on the control panel.

Parent topic: [Setting Up Fax Features Using the Product Control Panel](#)

Setting Up Fax Features Using the Fax Utility - Windows

You can set up your fax header and select your fax settings using the FAX Utility for Windows.

1. Do one of the following:
 - **Windows 8:** Navigate to the **Start** screen.
 - **Windows (other versions):** Click  or **Start > Programs** or **All Programs > EPSON Software**.
2. Select **FAX Utility**.

You see this window:



3. Select **Fax Settings for Printer**. (Select your product, if prompted.)

You see this window:

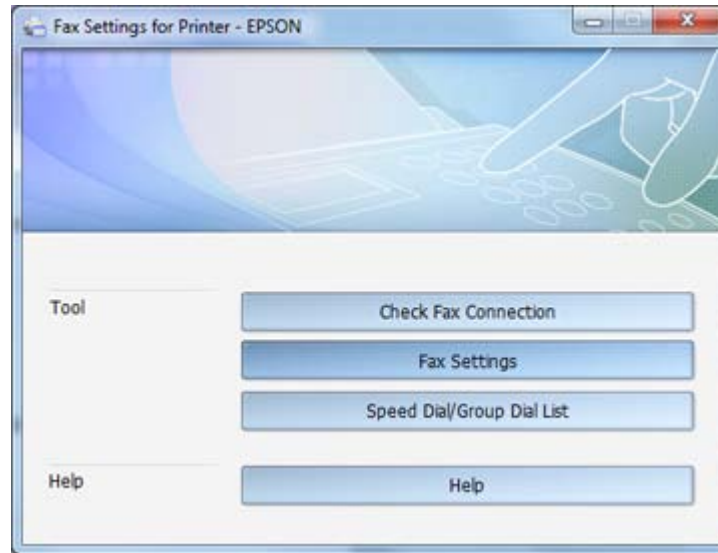

4. Select **Fax Settings**.
5. Follow the prompts that appear on the screen to enter your fax header information and select your fax settings.

Note: For detailed information, select the FAX Utility **Help** option.

Parent topic: [Setting Up Fax Features](#)

Setting Up Fax Features Using the Fax Utility - Mac OS X

You can set up your fax header and select your fax settings using the FAX Utility for Mac OS X.

1. Do one of the following:
 - **Mac OS X 10.6/10.7/10.8:** In the Apple menu or the Dock, select **System Preferences**. Select **Print & Fax** or **Print & Scan**, select the **FAX** option for your product, and select **Options & Supplies**. Select **Utility** and select **Open Printer Utility**.
 - **Mac OS X 10.5:** In the Apple menu or the Dock, select **System Preferences**. Select **Print & Fax**, select the **FAX** option for your product, and select **Open Print Queue**. Select **Utility**.
2. Double-click **FAX Utility**, if necessary.

You see this window:

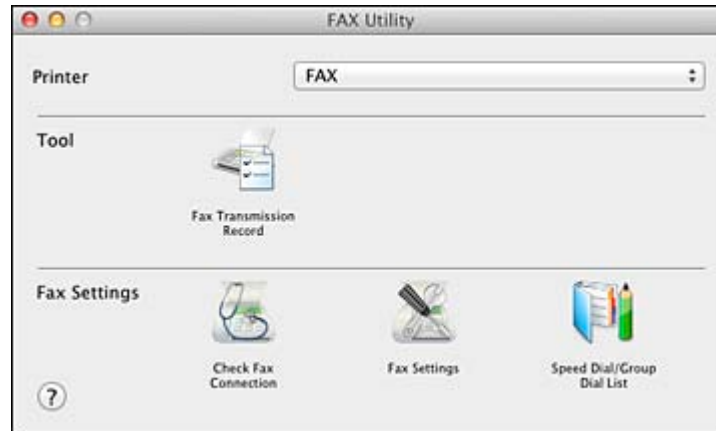

3. Select your **FAX** product in the Printer list.
4. Select **Fax Settings**.
5. Follow the prompts that appear on the screen to enter your fax header information and select your fax settings.

Note: For detailed information, select the FAX Utility ? icon.

Parent topic: [Setting Up Fax Features](#)

Setting Up Speed Dial and Group Dial Lists

You can set up a speed dial list of fax numbers so you can quickly select them for faxing. You can also set up a group dial list to send a fax message to multiple speed dial numbers.

See these sections to set up speed dial and group dial lists.

[Setting Up Speed/Group Dial Lists Using the Product Control Panel](#)

[Setting Up Speed/Group Dial Lists Using the Fax Utility - Windows](#)

[Setting Up Speed/Group Dial Lists Using the Fax Utility - Mac OS X](#)

Parent topic: [Faxing](#)

Setting Up Speed/Group Dial Lists Using the Product Control Panel

You can set up your speed dial and group dial lists using the control panel on your product.

[Creating Speed Dial List Entries](#)

[Printing Your Speed Dial List](#)

[Creating Group Dial List Entries](#)

[Printing Your Group Dial List](#)

Parent topic: [Setting Up Speed Dial and Group Dial Lists](#)

Creating Speed Dial List Entries

You can create a speed dial list of fax numbers to help you quickly send faxes.

Note: You can create up to 60 speed dial and group dial entries combined.

1. Press the  **Fax** button.

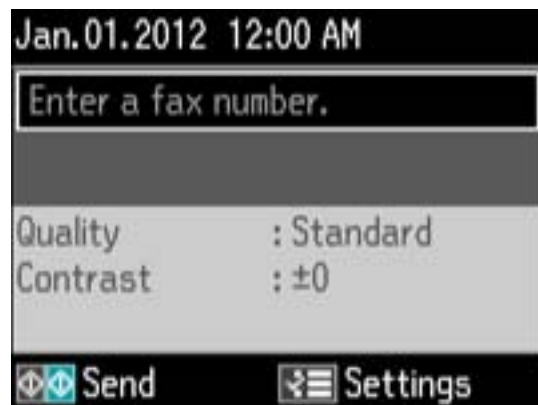

2. Press the  **Menu** button.
3. Press the up or down arrow buttons to select **Speed Dial Setup** and press the **OK** button.
4. Press the up or down arrow buttons to select **Create** and press the **OK** button.

You see this screen:

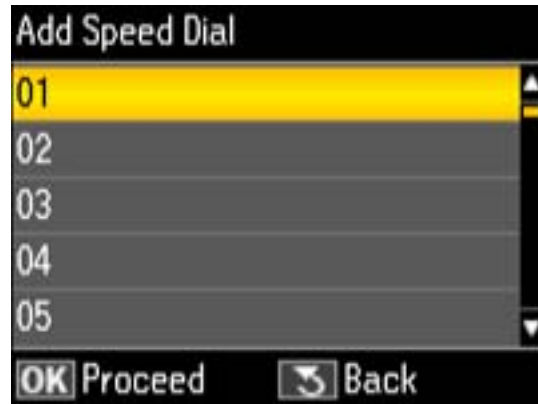

5. Select the number you want to use for the fax number you are adding and press the **OK** button.
6. Use the numeric buttons on the control panel to enter the fax number. You can enter up to 64 characters.
7. Press the **OK** button.

You see this screen:

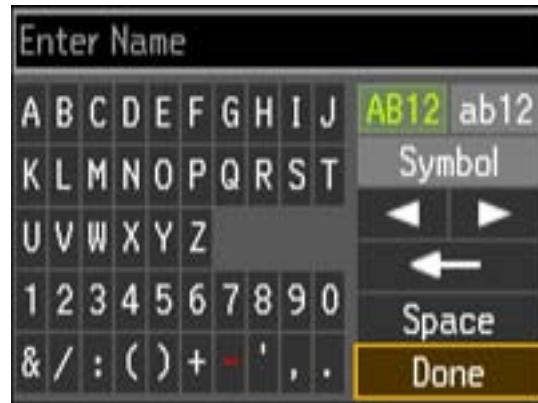

8. Use the keypad to enter a name for the speed dial entry. You can enter up to 30 characters.
9. Select **Done** and press the **OK** button.
You return to the Speed Dial Setup screen.

10. Do the following as necessary:

- To create additional entries, select **Create** and repeat the steps above.
- To edit an existing entry, press the up or down arrow buttons to select **Edit**, select the entry, press the **OK** button, and change the information.
- To delete an entry, press the up or down arrow buttons to select **Delete**, select the entry, press the **OK** button, and confirm the deletion.

Parent topic: [Setting Up Speed/Group Dial Lists Using the Product Control Panel](#)

Related tasks

[Entering Numbers and Characters for Faxing](#)

Printing Your Speed Dial List

You can print your speed dial list for easy reference.

1. Make sure you loaded letter-size or larger paper in your product.
2. Press the  **Fax** button.

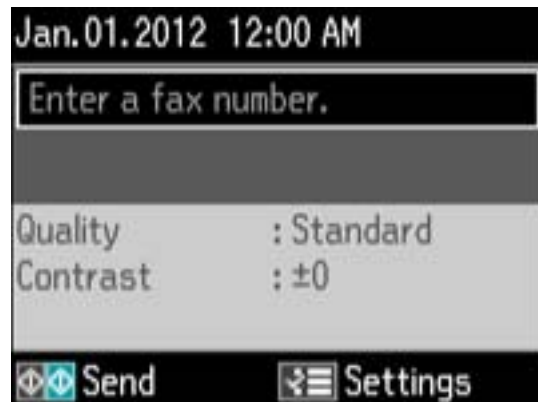

3. Press the  **Menu** button.
4. Press the up or down arrow buttons to select **Fax Report** and press the **OK** button.

You see this screen:



5. Select **Speed Dial List** and press the **OK** button.
6. Press one of the **Start** buttons to print the report.

Parent topic: [Setting Up Speed/Group Dial Lists Using the Product Control Panel](#)

Creating Group Dial List Entries

You can create a group dial list after creating a speed dial list. Each group dial list can include up to 30 fax numbers.

Note: You can create up to 60 speed dial and group dial entries combined.

1. Press the **Fax** button.

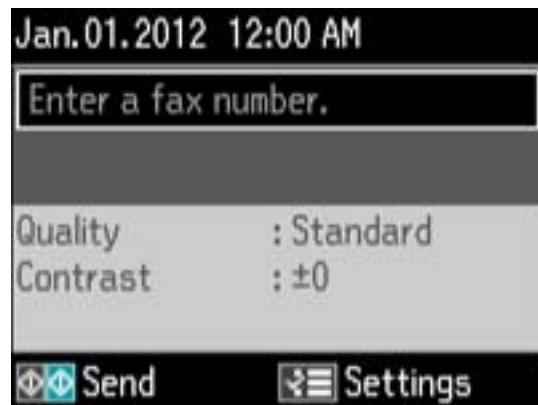

2. Press the  **Menu** button.
3. Press the up or down arrow buttons to select **Group Dial Setup** and press the **OK** button.
4. Press the up or down arrow buttons to select **Create** and press the **OK** button.

You see this screen:



5. Select the number you want to use for the group dial entry you are adding and press the **OK** button.

You see this screen:



6. Use the keypad to enter a name for the group dial entry. You can enter up to 30 characters.

7. Select **Done** and press the **OK** button.

You see a screen similar to this:

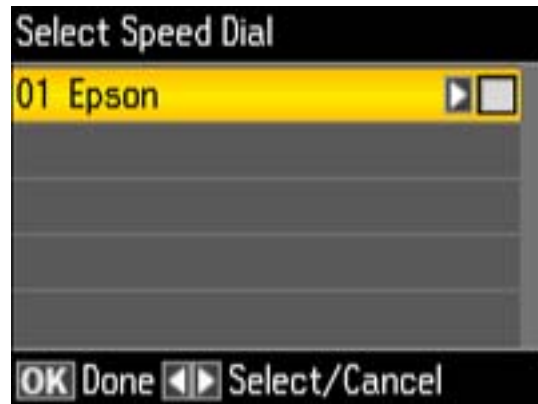

8. Press the up or down arrow buttons to highlight the speed dial entry you want to add to the group, and press the right arrow button to select it.
9. Continue selecting speed dial entries as necessary.
10. When you are finished, press the **OK** button.
You return to the Group Dial Setup screen.
11. Do the following as necessary:
 - To create additional entries, select **Create** and repeat the steps above.
 - To edit an existing entry, press the up or down arrow buttons to select **Edit**, select the entry, press the **OK** button, and change the information.
 - To delete an entry, press the up or down arrow buttons to select **Delete**, select the entry, press the **OK** button, and confirm the deletion.

Parent topic: [Setting Up Speed/Group Dial Lists Using the Product Control Panel](#)

Related tasks

[Entering Numbers and Characters for Faxing](#)

Printing Your Group Dial List

You can print your group dial list for easy reference.

1. Make sure you loaded letter-size or larger paper in your product.

2. Press the  **Fax** button.

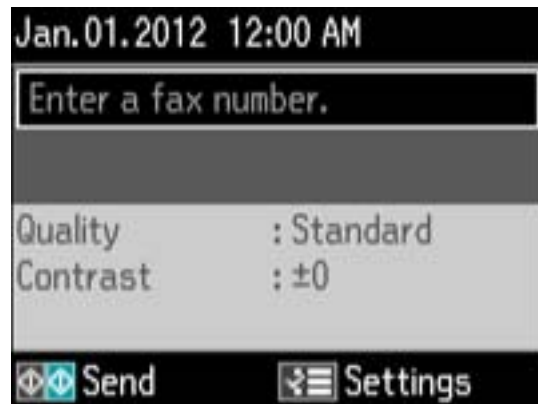

3. Press the  **Menu** button.
4. Press the up or down arrow buttons to select **Fax Report** and press the **OK** button.

You see this screen:



5. Select **Group Dial List** and press the **OK** button.
6. Press one of the  **Start** buttons to print the report.

Parent topic: [Setting Up Speed/Group Dial Lists Using the Product Control Panel](#)

Setting Up Speed/Group Dial Lists Using the Fax Utility - Windows

You can set up your speed dial and group dial lists using the FAX Utility for Windows. The utility also lets you import fax numbers from the Windows Address Book and back up fax numbers stored in your product's memory.

Note: You can create up to 60 speed dial and group dial entries combined.

1. Do one of the following:
 - **Windows 8:** Navigate to the **Start** screen.
 - **Windows (other versions):** Click  or **Start > Programs** or **All Programs > EPSON Software**.
2. Select **FAX Utility**.

You see this window:



3. Select **Fax Settings for Printer**. (Select your product, if prompted.)

You see this window:



4. Select **Speed Dial/Group Dial List**.
You see this window:

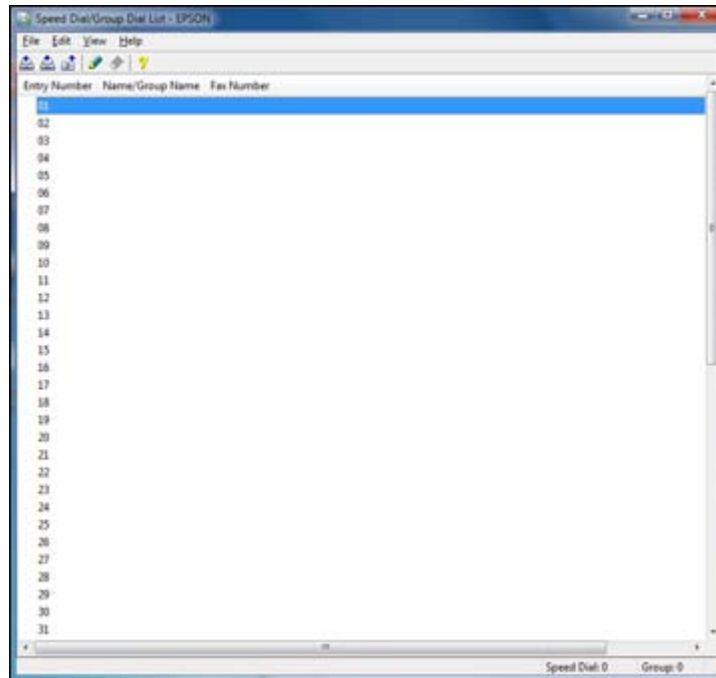

5. Select an empty entry and click the  icon.

Note: To edit an entry, select it and click the  icon. To delete an entry, select it and click the  icon.

6. Do one of the following:
 - To create a speed dial entry, select **Speed Dial**, enter a name and fax number, and click **OK**.
 - To create a group dial entry, select **Group**, enter a name, select your desired fax numbers, and click **OK**.
7. Repeat the previous steps as necessary to add all your speed dial or group dial entries.
8. When you are finished, click the  icon to save the entries to your product's memory.

Parent topic: [Setting Up Speed Dial and Group Dial Lists](#)

Setting Up Speed/Group Dial Lists Using the Fax Utility - Mac OS X

You can set up your speed dial and group dial lists using the FAX Utility. The utility also lets you import fax numbers from the MacAddress Book and back up fax numbers to your product's memory.

Note: You can create up to 60 speed dial and group dial entries combined.

1. Do one of the following:
 - **Mac OS X 10.6/10.7/10.8:** In the Apple menu or the Dock, select **System Preferences**. Select **Print & Fax** or **Print & Scan**, select the **FAX** option for your product, and select **Options & Supplies**. Select **Utility** and select **Open Printer Utility**.
 - **Mac OS X 10.5:** In the Apple menu or the Dock, select **System Preferences**. Select **Print & Fax**, select the **FAX** option for your product, and select **Open Print Queue**. Select **Utility**.
2. Double-click **FAX Utility**, if necessary.

You see this window:



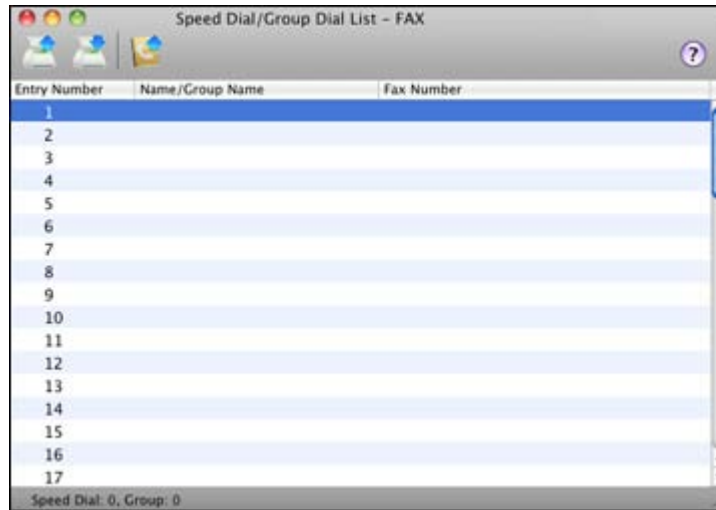

3. Select your **FAX** product in the Printer list.
4. Select **Speed Dial/Group Dial List**.

You see this window:



5. To add an entry, double-click an empty entry.

Note: To edit an entry, select it and change the information. To delete an entry, select it and press the **Delete** key on your keyboard.

6. Do one of the following:
 - To create a speed dial entry, select **Speed Dial**, enter a name and fax number, and click **OK**.
 - To create a group dial entry, select **Group Dial**, enter a name, select your desired fax numbers, and click **OK**.
7. Repeat the previous steps as necessary to add all your speed dial or group dial entries.
8. To import entries from your MacAddress book, click the  icon.
9. When you are finished, click the  icon to save the entries to your product's memory.

Parent topic: [Setting Up Speed Dial and Group Dial Lists](#)

Sending Faxes

See these sections to send faxes using your product.

[Sending Faxes from the Product Control Panel](#)

[Sending Faxes Using the Fax Utility - Windows](#)
[Sending Faxes Using the Fax Utility - Mac OS X](#)

Parent topic: [Faxing](#)

Sending Faxes from the Product Control Panel

See these sections to send faxes using the product's control panel.

[Manually Dialing or Redialing Fax Numbers](#)

[Selecting Fax Numbers From Speed or Group Dial Lists](#)

[Dialing Fax Numbers from a Connected Telephone](#)

[Broadcasting a Fax](#)

[Sending a Fax at a Specified Time](#)

[Fax Send Options](#)





Parent topic: [Sending Faxes](#)

Manually Dialing or Redialing Fax Numbers

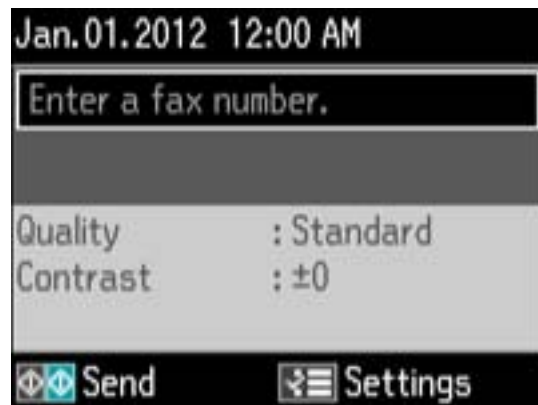
You can send a fax from your product control panel by manually dialing the fax number or redialing the last dialed fax number.

1. Place your original on the product for faxing.
2. Press the  **Fax** button.



3. Do one of the following:
 - Use the numeric keypad to enter the fax number. You can enter up to 64 characters.
 - Press the  **Redial/Pause** button to redial the last dialed fax number.
4. If you need to change any fax settings, press the  **Menu** button, select **Send Settings**, press the **OK** button, and select your settings. When you finish selecting settings, press the  **Menu** button.
5. Press one of the  **Start** buttons.

Note: If your recipient's fax machine does not print in color, your fax is automatically sent in black-and-white. To cancel faxing, press the  **Stop/Reset** button.

Your product scans your original and prompts you to place additional pages, if necessary. After scanning your originals, your product dials the number and sends the fax.

Note: If the number is busy or there is a communication problem, your product displays a redialing message and will redial the number in a few minutes.





Parent topic: [Sending Faxes from the Product Control Panel](#)

Selecting Fax Numbers From Speed or Group Dial Lists

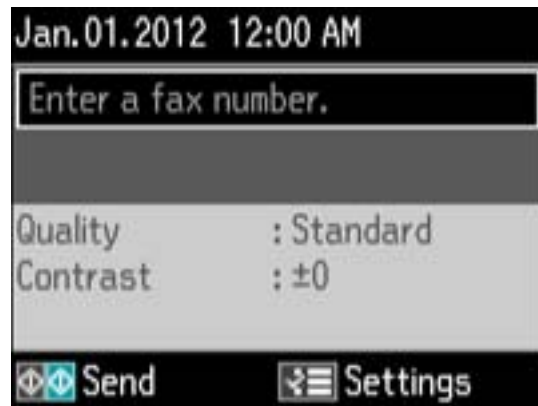
You can send a fax from your product control panel by selecting a speed dial or group dial entry from the list.

1. Place your original on the product for faxing.
2. Press the  **Fax** button.



3. Press the  **Speed Dial/Group Dial** button. If you want to select a group dial entry, press the button twice.
4. Select the speed dial or group dial entry you want to use, then press the **OK** button.
5. If you need to change any fax settings, press the  **Menu** button, select **Send Settings**, press the **OK** button, and select your settings. When you finish selecting settings, press the  **Menu** button.
6. Press one of the  **Start** buttons.

Your product scans your original and prompts you to place additional pages, if necessary.

Note: If your recipient's fax machine does not print in color, your fax is automatically sent in black-and-white. To cancel faxing, press the  **Stop/Reset** button.

After scanning your originals, your product dials the number and sends the fax.

Note: If the number is busy or there is a communication problem, your product displays a redialing message and will redial the number in a few minutes.

Parent topic: [Sending Faxes from the Product Control Panel](#)

Dialing Fax Numbers from a Connected Telephone

If you have connected a telephone to the **EXT** port on your product, you can send a fax by dialing the fax number from the connected telephone.

1. Place your original on the product for faxing.
2. Press the  **Fax** button.

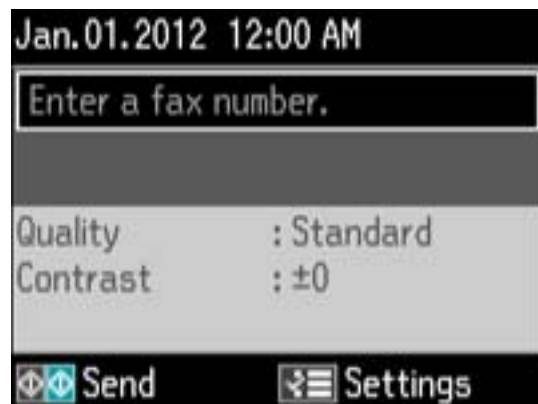

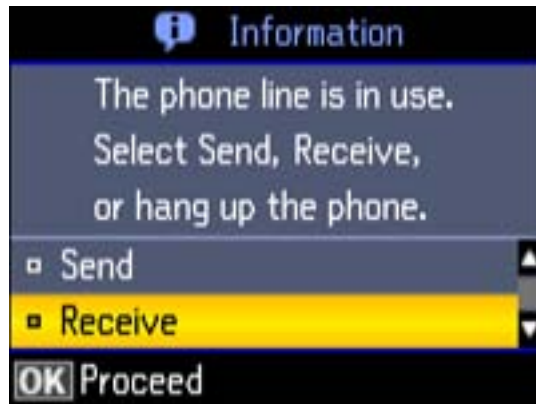

3. Dial the fax number from the connected telephone.

You see this screen:



4. Using your product control panel, select **Send** and press the **OK** button.

Note: Your product now communicates with the recipient's fax machine.

5. If you need to change any fax settings, press the  **Menu** button, select **Send Settings**, press the **OK** button, and select your settings. When you finish selecting settings, press the  **Menu** button.

6. Press one of the  **Start** buttons.

Your product scans your original and prompts you to place additional pages, if necessary.

Note: If your recipient's fax machine does not print in color, your fax is automatically sent in black-and-white. To cancel faxing, press the  **Stop/Reset** button.

7. Hang up the telephone.

After scanning your originals, your product sends the fax.

Parent topic: [Sending Faxes from the Product Control Panel](#)





Broadcasting a Fax

You can easily send a fax to several recipients at the same time using your speed dial list or group dial list, or by entering phone numbers. You can send the same fax to up to 30 phone numbers.

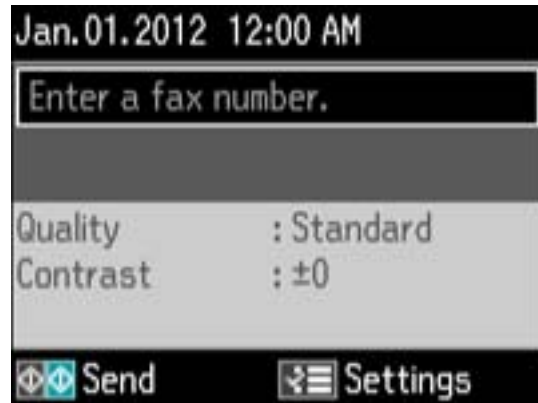
Note: You can only send faxes in black-and-white when you use this option.

1. Place your original on the product for faxing.
2. Press the  **Fax** button.



3. Press the  **Menu** button, press the up or down arrow buttons to select **Broadcast Fax**, and press the **OK** button.
4. Do the following as necessary:
 - Use the numeric keypad to manually enter fax numbers. Press the down arrow button to add additional fax numbers.
 - To select a speed or group dial entry, press the  **Menu** button. Use the up and down arrows to highlight an entry, the right arrow button to select an entry, and the left arrow button to deselect an entry.
5. When you have finished selecting your recipients, press the **OK** button.
6. If you need to change any fax settings, press the  **Menu** button, select **Send Settings**, press the **OK** button, and select your settings. When you finish selecting settings, press the  **Menu** button.
7. Press the  **Start B&W** button. If prompted, select where you placed your document (Automatic Document Feeder or scanner glass).

Note: To cancel faxing, press the  **Stop/Reset** button.

Your product scans your original and prompts you to place additional pages, if necessary.

After scanning your originals, your product dials the number and sends the fax.

Note: If the number is busy or there is a communication problem, your product displays a redialing message and will redial the number in a few minutes.

Parent topic: [Sending Faxes from the Product Control Panel](#)





Sending a Fax at a Specified Time

You can send a fax at a time of your choice.

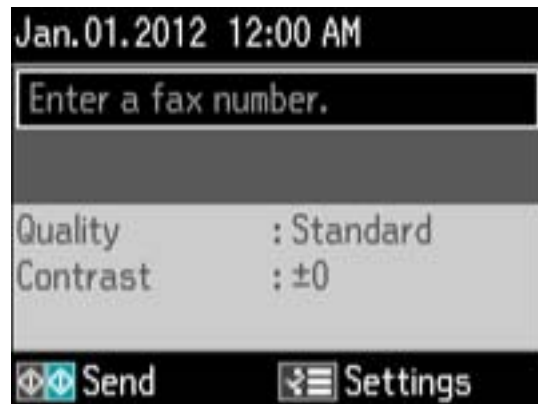
Note: You can only send faxes in black-and-white when you use this option.

1. Place your original on the product for faxing.
2. Press the  **Fax** button.



3. Enter a phone number or select a number from a speed or group dial list.
4. Press the  **Menu** button, press the up or down arrow buttons to select **Send Fax Later**, and press the **OK** button.
5. Press the up or down arrow buttons to select **On**, use the number pad to enter your desired time, press the **OK** button, then press the  **Back** button.
6. If you need to change any fax settings, press the  **Menu** button, select **Send Settings**, press the **OK** button, and select your settings. When you finish selecting settings, press the  **Menu** button.

- Press the **Start B&W** button. If prompted, select where you placed your document (Automatic Document Feeder or scanner glass).

Note: To cancel faxing, press the **Stop/Reset** button.

Your product scans your original and prompts you to place additional pages, if necessary.

After scanning your originals, your product dials the number and sends the fax at the specified time. You cannot send additional faxes until the timed fax has been sent.

Note: If the number is busy or there is a communication problem, your product displays a redialing message and will redial the number in a few minutes.

Parent topic: [Sending Faxes from the Product Control Panel](#)

Fax Send Options

While sending a fax, you can select these options.

Setting	Options	Description
Quality	Standard	Provides good scan resolution and print quality for most faxes.
	Fine	Provides best scan resolution and print quality for faxes of small print and line art.
	Photo	Provides best scan resolution and print quality for faxed photos.
Contrast	-4 to +4	Adjusts the contrast for faxes; negative settings make faxes lighter and positive settings make faxes darker.

Parent topic: [Sending Faxes from the Product Control Panel](#)

Sending Faxes Using the Fax Utility - Windows

You can send a fax from a printing program in Windows. You can fax up to 100 pages at a time, including a cover sheet.

- Open the file you want to fax and select the print command.

You see a window like this:

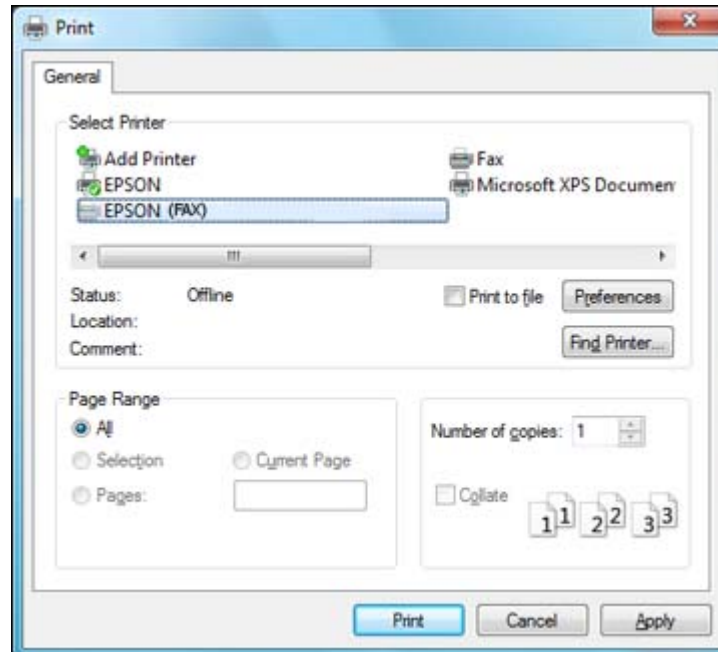

2. Select your product with the **FAX** option as the printer.
3. To change the Paper Size, Orientation, Color, Image Quality, or Character Density settings, click the **Preferences** or **Properties** button.

Note: If you see a **Setup**, **Printer**, or **Options** button, click it. Then click **Preferences** or **Properties** on the next screen. For more information about selecting fax print settings, click **Help**.

4. Select the Page Range as necessary. (Leave the Number of copies set to 1.)
5. Click **Print**.

If you're faxing for the first time, you see a window like this one:

1. Open the file you want to fax.
2. Select the print command in your application.

Note: You may need to select a print icon on your screen, the **Print** option in the **File** menu, or another command. See your application's help utility for details.



3. Select your product **FAX** option as the **Printer** setting.
4. If necessary, click the arrow next to the Printer setting or the **Show Details** button to expand the print window.
5. Select the number of pages you are faxing as the **Pages** setting.

Note: Leave the **Copies** setting set to **1**.

6. Select **Recipient Settings** from the pop-up menu.

You see this window:

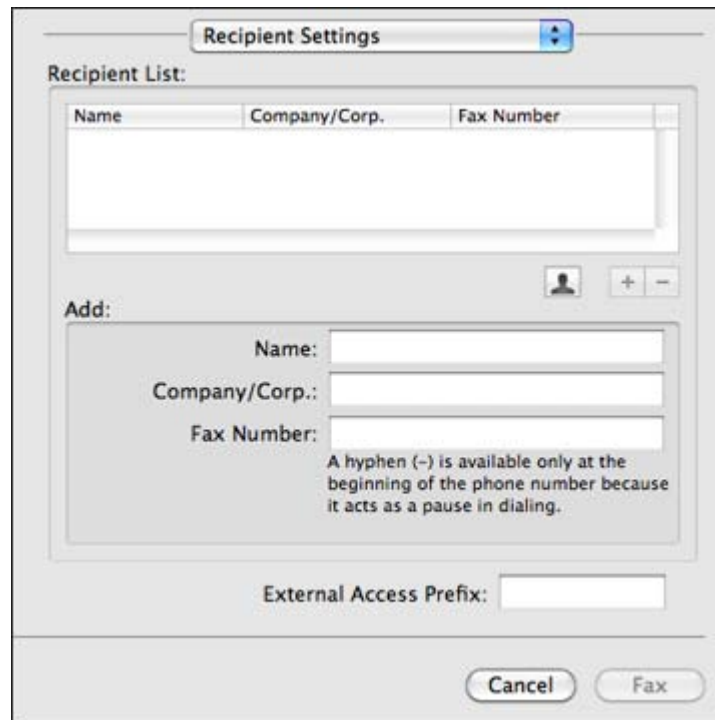

The image shows a 'Recipient Settings' dialog box. At the top, there is a title bar with the text 'Recipient Settings' and a blue close button. Below the title bar, the text 'Recipient List:' is followed by a table with three columns: 'Name', 'Company/Corp.', and 'Fax Number'. The table is currently empty. To the right of the table are three buttons: a person icon, a plus sign, and a minus sign. Below the table, the text 'Add:' is followed by three input fields labeled 'Name:', 'Company/Corp.:', and 'Fax Number:'. Below these fields is a note: 'A hyphen (-) is available only at the beginning of the phone number because it acts as a pause in dialing.' At the bottom of the dialog box, there is an 'External Access Prefix:' label followed by an input field. At the very bottom, there are two buttons: 'Cancel' and 'Fax'.

7. Do one of the following to choose your recipient:
 - Select a name or group from the **Recipient List**.
 - Enter a name, company, and fax number and click the **+** button.
 - Click the  icon and select a recipient from your address book.
8. Select **Fax Settings** from the pop-up menu.

You see this window:

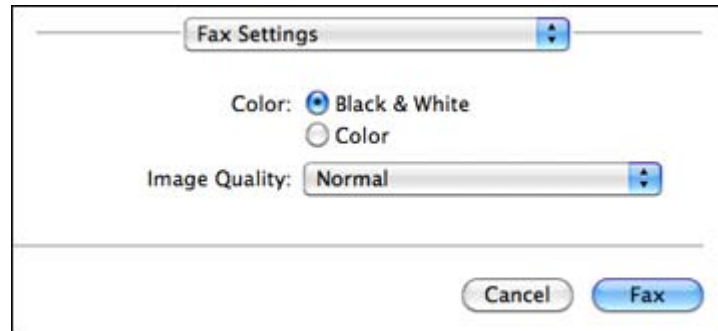

9. Select the **Color** and **Image Quality** settings you want to use for your fax.

10. Click **Fax**.

Parent topic: [Sending Faxes](#)

Receiving Faxes

See these sections to receive faxes with your product.

Note: Do not turn the product off while it is receiving a fax. Otherwise, the fax transmission will be lost.

[Fax Reception](#)

[Receiving Faxes Automatically \(Auto Answer\)](#)

[Receiving Faxes Manually](#)

Parent topic: [Faxing](#)

Fax Reception

Your product will automatically receive and print faxes when you set fax reception to Auto Answer mode.

If you connected a telephone to your product so you can use the same phone line for faxes and voice calls, you can also set your product to receive faxes manually. This allows you to check for a fax tone using the telephone and press a button on your product to receive the fax.

Make sure to load paper in your product and select your fax settings before receiving a fax.

Note: If you run out of paper during fax printing, load more paper and press the button indicated on your product's LCD screen to continue.

Note: Do not turn the product off while it is receiving a fax. Otherwise, the fax transmission will be lost.

Parent topic: [Receiving Faxes](#)

Receiving Faxes Automatically (Auto Answer)

To receive and print faxes automatically, you can turn on **Auto Answer** mode.

If an answering machine is connected, make sure the product's **Rings to Answer** setting is set higher than the number of rings your answering machine is set to answer a call. For example, if the answering machine is set to pick up on the fourth ring, set the product to pick up on the fifth ring or later.

If a telephone is connected, and you use it to answer a call that turns out to be a fax, wait until the product's LCD screen displays a message that a connection has been made before hanging up.

Parent topic: [Receiving Faxes](#)

Related tasks

[Selecting Fax Send and Receive Settings](#)

[Selecting Fax Communication Settings](#)

Receiving Faxes Manually

You can set up your product to receive faxes manually by turning off **Auto Answer** mode. This lets you check for a fax tone on the connected telephone before receiving a fax.

1. When the connected telephone rings, answer the call.

You see this message on your product's LCD screen:

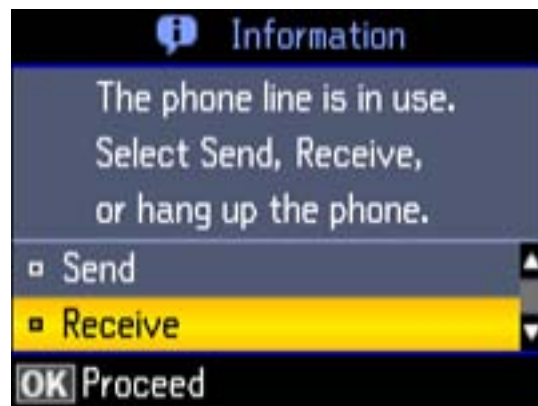

2. If you hear a fax tone, select the **Receive** option and press the **OK** button.

Note: Leave the answered call active as you receive the fax transmission.

3. Follow the instructions on the screen to receive the fax.
When fax transmission is finished, you see the previous LCD screen.
4. Hang up the phone.
5. Press one of the **Start** buttons to print the fax.

Parent topic: [Receiving Faxes](#)

Related tasks

[Selecting Fax Send and Receive Settings](#)

Using USB Flash Drives With Your Product

Follow the instructions here to work with a USB flash drive inserted into your product.

[Inserting a USB Flash Drive](#)

[Removing a USB Flash Drive](#)

[Transferring Files on a USB Flash Drive](#)

Inserting a USB Flash Drive

Insert your USB flash drive into the USB port on the front of the product.

Parent topic: [Using USB Flash Drives With Your Product](#)

Related references

[External USB Device Specifications](#)

Removing a USB Flash Drive

After you finish working with a USB flash drive, follow these steps to remove it.

1. If your product is connected to your computer using a USB cable, do one of the following:
 - **Windows:** Open the **My Computer**, **Computer**, or **Windows Explorer** utility. Then right-click the name of your memory card (listed as a removable disk) and select **Eject**.
 - **Mac OS X:** Drag the removable disk icon for your memory card from the desktop into the trash.

Caution: Do not remove a flash drive before completing the procedure above or you may lose data from the flash drive.

2. Pull the flash drive out of the USB port on the front of the product.

Parent topic: [Using USB Flash Drives With Your Product](#)

Transferring Files on a USB Flash Drive

You can transfer files to and from a USB flash drive inserted into the USB port on the front of your product.

[Setting Up File Sharing for File Transfers From Your Computer](#)

[Transferring Files from a USB Flash Drive to Your Computer](#)

Parent topic: [Using USB Flash Drives With Your Product](#)

Setting Up File Sharing for File Transfers From Your Computer

Before you transfer files from a computer to a USB flash drive inserted into the USB port on the front of your product, you may need to set up your product's file sharing settings.

Caution: Remove the flash drive before you change this setting or you may lose data from the flash drive.

1. Press the  **Menu** button.
2. Press the up or down arrow buttons to select **File Sharing Setup** and press the **OK** button.



3. Press the up or down arrow buttons to select your connection type and press the **OK** button.

Parent topic: [Transferring Files on a USB Flash Drive](#)

Related tasks

[Removing a USB Flash Drive](#)

Transferring Files from a USB Flash Drive to Your Computer

You can transfer files to and from a USB flash drive inserted into the USB port on the front of your product and a computer connected to your product.

Note: Do not transfer files to and from a flash drive while you are scanning to the flash drive.

1. Make sure your product is connected to a computer.

2. Insert a flash drive into the USB port on the front of your product.
3. Do one of the following to access your flash drive files from your computer:
 - **Windows:** Select the **Computer** or **My Computer** utility, then select the removable disk icon.
 - **Mac OS X with a USB connection:** Look for the removable disk icon on your desktop, then select it.
 - **Mac OS X with a network connection:** Select the hard drive icon on your desktop or select **Computer** from the **Go** menu, select your product in the **SHARED** section of the sidebar (you may need to widen the sidebar to see the name), then select the **USBSTORAGE** icon.
4. Select the folder that contains your files.
5. Drag the files you want to transfer to the desired folder on your computer or on your flash drive.

Note: Your product's LCD screen does not update to display new information about your flash drive after you copy files to it or delete files from it. Remove and insert the flash drive to update the information.

Parent topic: [Transferring Files on a USB Flash Drive](#)

Related tasks

[Inserting a USB Flash Drive](#)

[Setting Up File Sharing for File Transfers From Your Computer](#)

[Removing a USB Flash Drive](#)

Replacing Ink Cartridges

When an ink cartridge is expended, you need to replace it.

You may also need to replace a cartridge that is more than six months old, if your printouts do not look their best, even after cleaning and aligning the print head.

Note: Please dispose of your used Epson branded ink cartridges responsibly and in accordance with local requirements. If you would like to return your used ink cartridges to Epson for proper disposal, please go to www.epson.com/recycle for more information.

[Check Cartridge Status](#)

[Purchase Epson Ink Cartridges](#)

[Removing and Installing Ink Cartridges](#)

[Replacing Ink Cartridges Using a Computer Utility](#)

[Printing With Black Ink and Expended Color Cartridges](#)

[Conserving Low Black Ink with Windows](#)

Check Cartridge Status

Your product and its printing software will let you know when an ink cartridge is low or expended.

[Checking Cartridge Status on the LCD Screen](#)

[Checking Cartridge Status with Windows](#)

[Checking Cartridge Status with Mac OS X](#)

Parent topic: [Replacing Ink Cartridges](#)

Checking Cartridge Status on the LCD Screen

You can check the status of your ink cartridges using your product's LCD screen.

1. Press the  **Menu** button.
2. Press the up or down arrow buttons to select **Ink Levels** and press the **OK** button.

You see a screen like this:

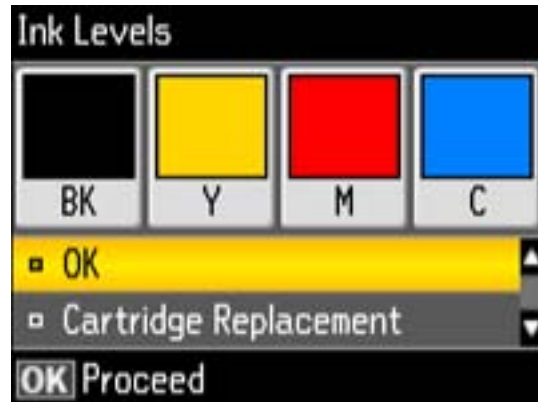

Note: The display is different depending on which ink cartridges are low or expended, if any. Displayed ink levels are approximate.

3. Do one of the following:
 - If you are finished, select **OK** and press the **OK** button.
 - If you want to replace an ink cartridge now, select **Cartridge Replacement** and press the **OK** button. When you finish replacing cartridges, press the **OK** button again.

Parent topic: [Check Cartridge Status](#)

Related tasks

[Removing and Installing Ink Cartridges](#)

Checking Cartridge Status with Windows

A low ink reminder appears if you try to print when ink is low, and you can check your cartridge status at any time using a utility on your Windows computer.

1. To check your cartridge status, double-click the product icon in the Windows taskbar, then click the **Details** button in the window that appears.

You see a window like this:

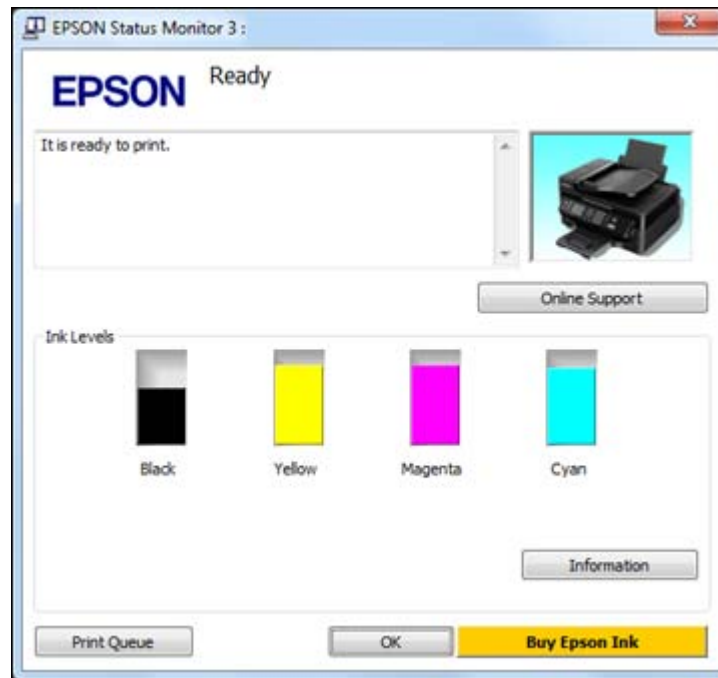

2. Replace or reinstall any ink cartridge indicated on the screen.

Note: Depending on the color of the expended cartridge and how you are printing, you may be able to continue printing temporarily.

Note: If any of the cartridges installed in the product is broken, incompatible with the product model, or improperly installed, Epson Status Monitor will not display an accurate cartridge status.

3. To disable the low ink reminder, right-click the product icon in the Windows taskbar and select **Monitoring Preferences**.

You see a window like this:

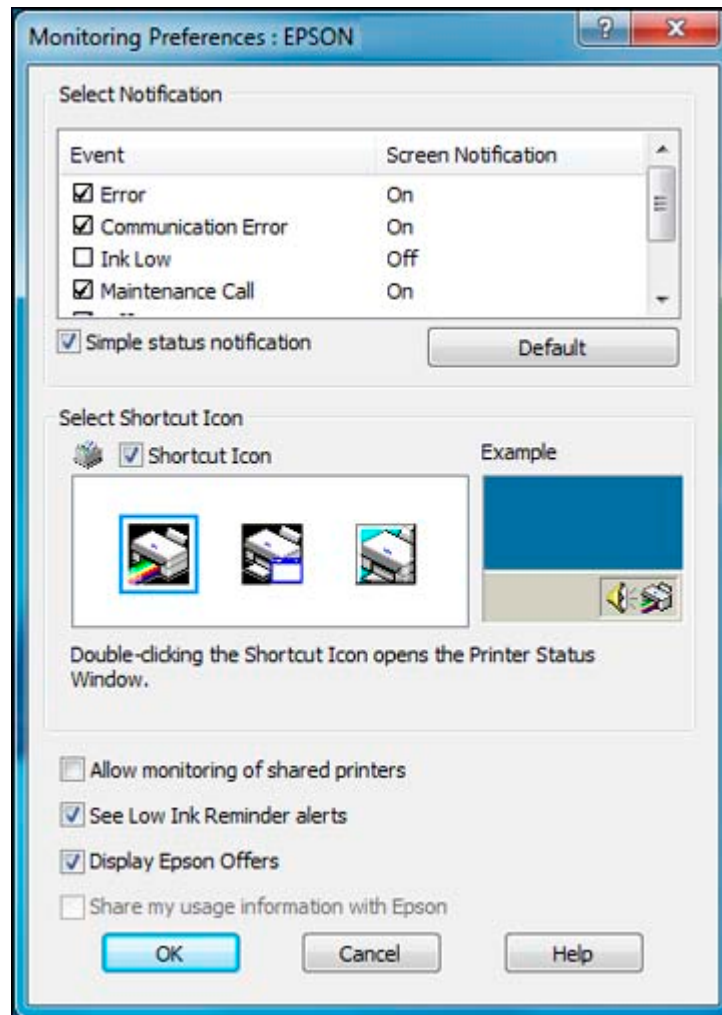

4. Deselect the **See Low Ink Reminder alerts** checkbox at the bottom of the screen.

5. To disable promotional offers, deselect the **Display Epson Offers** checkbox.

Parent topic: [Check Cartridge Status](#)

Related tasks

[Removing and Installing Ink Cartridges](#)

Related topics

[Printing With Black Ink and Expended Color Cartridges](#)

Checking Cartridge Status with Mac OS X

You can check your cartridge status using a utility on your Mac.

1. Do one of the following:
 - **Mac OS X 10.6/10.7/10.8:** In the Apple menu or the Dock, select **System Preferences**. Select **Print & Fax** or **Print & Scan**, select your product, and select **Options & Supplies**. Select **Utility** and select **Open Printer Utility**.
 - **Mac OS X 10.5:** In the Apple menu or the Dock, select **System Preferences**. Select **Print & Fax**, select your product, and select **Open Print Queue**. Select **Utility**.
2. Select **EPSON Status Monitor**.

You see this window:



3. Do the following as necessary:
 - You can update the ink cartridge status by clicking **Update**.
 - Replace or reinstall any ink cartridge indicated on the screen.

Note: Depending on the color of the expended cartridge and how you are printing, you may be able to continue printing temporarily.

Note: If any of the cartridges installed in the product is broken, incompatible with the product model, or improperly installed, Epson Status Monitor will not display an accurate cartridge status.

Parent topic: [Check Cartridge Status](#)

Related tasks[Removing and Installing Ink Cartridges](#)**Related topics**[Printing With Black Ink and Expanded Color Cartridges](#)

Purchase Epson Ink Cartridges

You can purchase genuine Epson ink and paper at Epson Supplies Central at www.epson.com/ink3 (U.S. sales) or www.epson.ca (Canadian sales). You can also purchase supplies from an Epson authorized reseller. To find the nearest one, call 800-GO-EPSON (800-463-7766).

Note: We recommend that you use genuine Epson cartridges and do not refill them. The use of other products may affect your print quality and could result in printer damage.

The cartridges included with the printer are designed for printer set up and not for resale. After some ink is used for priming, the rest is available for printing. Yields vary considerably based on images printed, print settings, paper type, frequency of use, and temperature. For print quality, a variable amount of ink remains in the cartridge after the "replace cartridge" indicator comes on.

[Ink Cartridge Part Numbers](#)

Parent topic: [Replacing Ink Cartridges](#)

Ink Cartridge Part Numbers

Use these part numbers when you order or purchase new ink cartridges.

Note: For best printing results, use up a cartridge within 6 months of opening the package.

Ink color	Part number	
	Standard-capacity	High-capacity
Black	200	200XL
Cyan	200	200XL
Magenta	200	200XL
Yellow	200	200XL

Parent topic: [Purchase Epson Ink Cartridges](#)

Removing and Installing Ink Cartridges

Make sure you have your replacement cartridges handy before you begin. You must install new cartridges immediately after removing the old ones.

Caution: Leave your old cartridges in the printer until you are ready to replace them to prevent the print head nozzles from drying out. Do not open ink cartridge packages until you are ready to install the ink. Cartridges are vacuum packed to maintain reliability.

1. Turn on your product.
 - If an ink cartridge is expended, you see a message on the LCD screen. Note which cartridges need to be replaced and press the **OK** button, then choose **Replace now**.



- If you are replacing a cartridge before you see a message on the LCD screen, press the **Menu** button, press the up or down arrow buttons to select **Maintenance**, press the up or down arrow buttons to select **Ink Cartridge Replacement** and press the **OK** button.

2. Lift up the scanner unit.

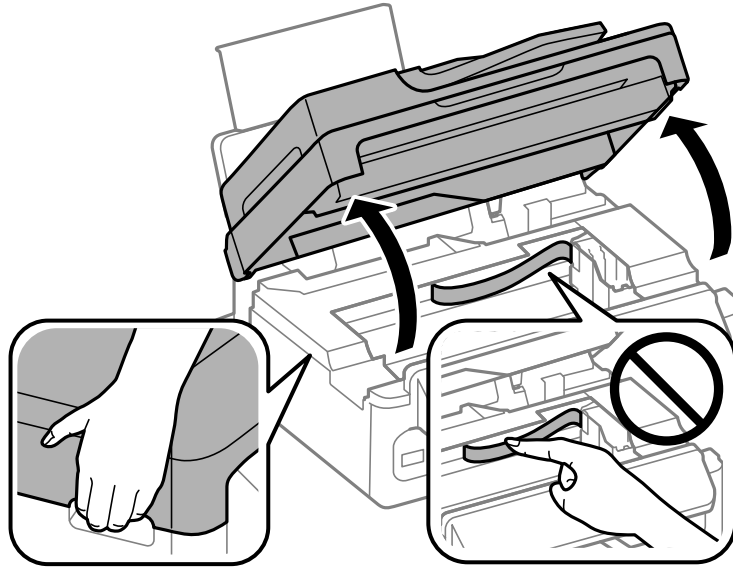

Caution: Do not move the print head by hand; otherwise, you may damage your product. Do not touch the flat white cable inside the printer.

Caution: Do not lift up the scanner unit when the document cover is open.

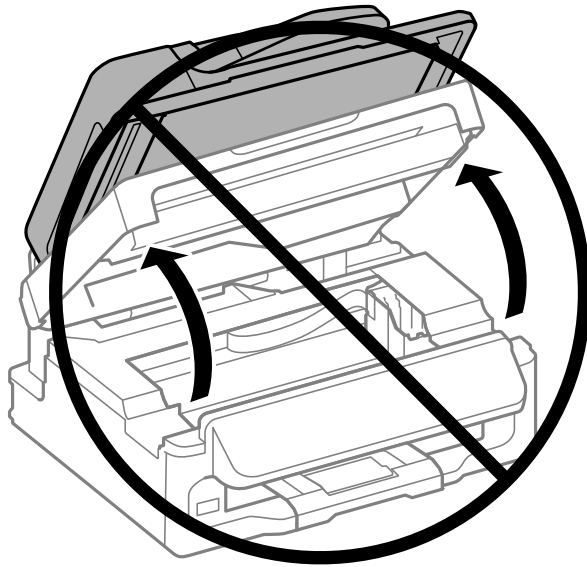

3. Squeeze the tab on the cartridge and lift the cartridge straight up to remove it.

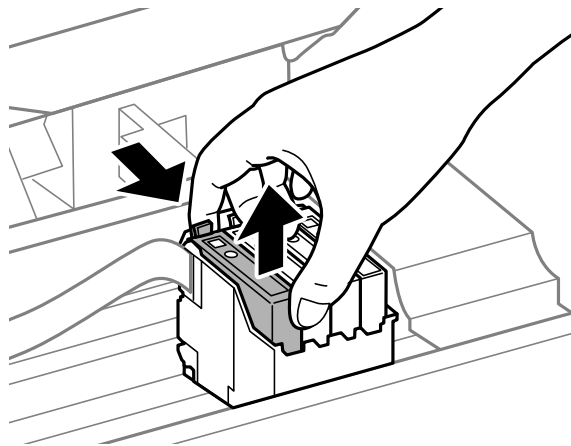

Note: Dispose of used cartridges carefully. Do not take the used cartridge apart or try to refill it.

Warning: If ink gets on your skin, wash it thoroughly with soap and water. If ink gets into your eyes, flush them immediately with water. If ink gets into your mouth, spit it out and see a doctor right away. Keep ink cartridges out of the reach of children.

4. Before opening the new cartridge package, shake it gently four or five times.

Caution: Do not shake the cartridges after opening the packages, or ink may leak.

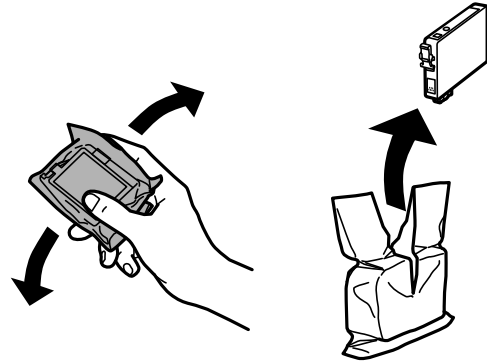

5. Remove the cartridge from the package.

Caution: Do not touch the green chip or the small window on the cartridge. Install the new cartridge immediately after removing the old one; if you do not, the print head may dry out and be unable to print.

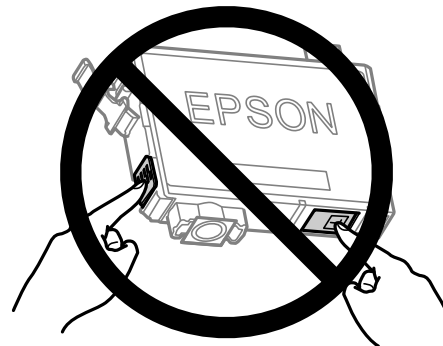

6. Remove the yellow tape from the side of the cartridge.

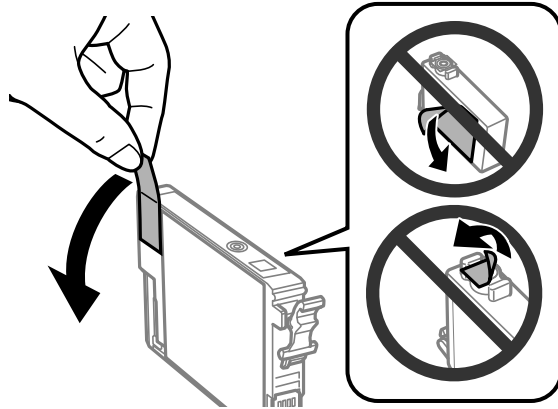

Caution: Do not remove any other labels or seals, or ink will leak.

7. Insert the new cartridge into the holder and push it down until it clicks into place.

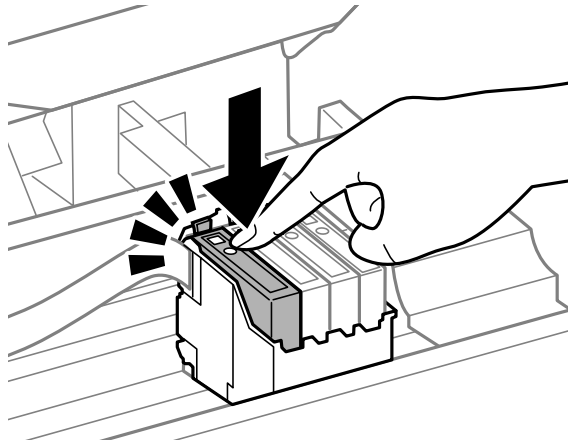

8. Lower the scanner unit.

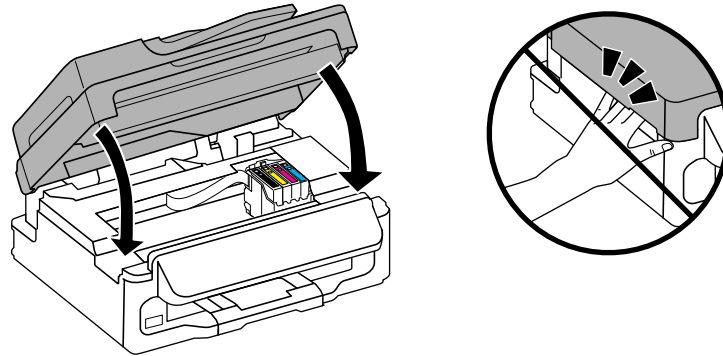

9. Press the **OK** button.

The print head moves to its home position and the printer starts charging the ink. This takes about 90 seconds. When you see a confirmation message on the screen, ink charging is finished.

Caution: Never turn off the product while the power light is flashing or you will waste ink.

If you see an error screen telling you an ink cartridge is installed incorrectly, press the **OK** button, lift up the scanner unit, and press the ink cartridge down until it clicks into place. When you're finished, press the **OK** button again.

If you remove a low or expended ink cartridge, you cannot re-install and use the cartridge.

Caution: If you remove an ink cartridge for later use, protect the ink supply area from dirt and dust and store it in the same environment as the printer. The valve in the ink supply port is designed to contain any excess ink, but do not touch the ink supply port or surrounding area. Always store ink cartridges with the label facing up; do not store cartridges upside-down.

Note: If you replace a cartridge while copying a document or photo on the scanner glass, cancel printing and make sure your original is still placed correctly on the document table. Then copy your original again.

Parent topic: [Replacing Ink Cartridges](#)

Related concepts

[Purchase Epson Ink Cartridges](#)

Related tasks

[Placing Originals on the Scanner Glass](#)

Replacing Ink Cartridges Using a Computer Utility

You can use the Ink Cartridge Replacement utility to view on-screen instructions for replacing an ink cartridge. This method allows you to replace a cartridge before it is low or expended (if it is too old, for example).

1. Do one of the following:
 - **Windows:** Right-click the product icon in the Windows taskbar and select **Printer Settings**. Then click the **Maintenance** tab.
 - **Mac OS X 10.6/10.7/10.8:** In the Apple menu or the Dock, select **System Preferences**. Select **Print & Fax** or **Print & Scan**, select your product, and select **Options & Supplies**. Select **Utility** and select **Open Printer Utility**.
 - **Mac OS X 10.5:** In the Apple menu or the Dock, select **System Preferences**. Select **Print & Fax**, select your product, and select **Open Print Queue**. Select **Utility**.

You see a window like this:

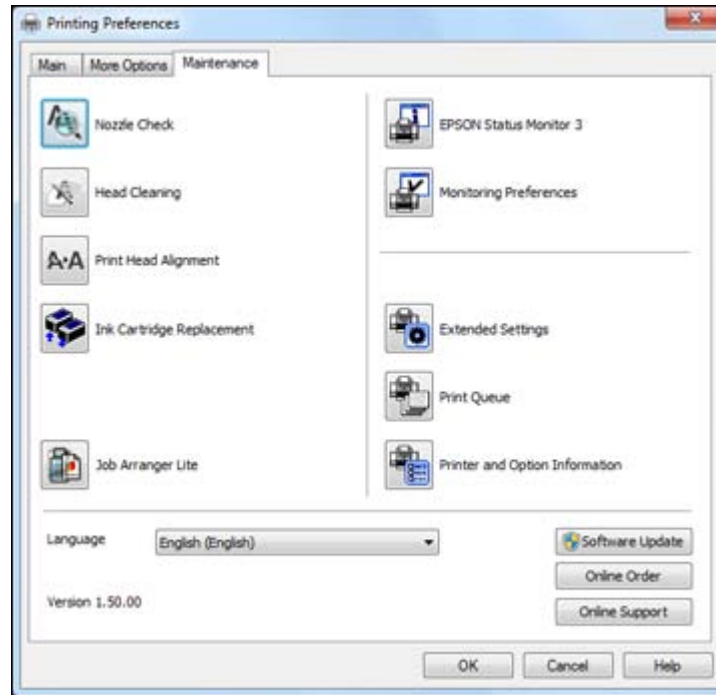

2. Click the **Ink Cartridge Replacement** icon and follow the on-screen instructions to replace your ink cartridges as necessary.

Parent topic: [Replacing Ink Cartridges](#)

Related concepts

[Purchase Epson Ink Cartridges](#)

Printing With Black Ink and Expended Color Cartridges

When a color ink cartridge is expended, you can temporarily continue printing from your computer using black ink. Replace the expended color cartridge as soon as possible for future printing.

Note: You cannot print with expended color ink cartridges using your product's control panel.

[Printing With Expended Color Cartridges - Windows](#)

[Printing With Expended Color Cartridges - Mac OS X](#)

Parent topic: [Replacing Ink Cartridges](#)

Printing With Expended Color Cartridges - Windows

If you see a message during printing telling you that you can temporarily print in black ink with an expended color cartridge, you can cancel your print job and select settings to print on plain paper or on an envelope.

Note: To use this feature, Epson Status Monitor must be enabled.

1. Click **Stop** or **Cancel Print** to cancel your print job.

Note: If the message screen appears on another computer on a network, you may need to cancel the print job using the product control panel.

2. Load plain paper or an envelope in your product.
3. Access the print settings in your print application.
4. Click the **Main** tab.
5. Select **Plain Paper/Bright White Paper** or **Envelope** as the paper type setting.
6. Select the **Black/Grayscale** checkbox.
7. Click **OK**.
8. Print your document.
Epson Status Monitor 3 displays a print message.
9. Click **Print in Black** to print your document.

Parent topic: [Printing With Black Ink and Expended Color Cartridges](#)

Related tasks

[Selecting Basic Print Settings - Windows](#)

[Cancelling Printing Using a Product Button](#)

Printing With Expended Color Cartridges - Mac OS X

If printing stops, you can cancel your print job and select settings to temporarily print with only black ink on plain paper or on an envelope.

1. Click the printer icon in the Dock.

2. If you see a message telling you that you can temporarily print with only black ink, click the **Delete** icon to cancel your print job.

Note: If the message screen appears on another computer on a network, you may need to cancel the print job using the product control panel.

3. In the Apple menu or the Dock, select **System Preferences**.
4. Select **Print & Fax** or **Print & Scan**, select your product, and select **Options & Supplies**.
5. Select **Driver**.

You see this screen:

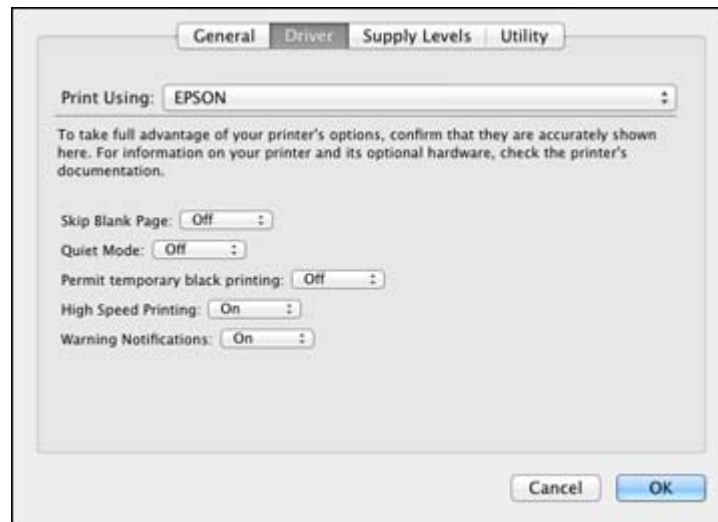

6. Select **On** as the **Permit temporary black printing** setting.
7. Click **OK**.
8. Close the utility window.
9. Load plain paper or an envelope in your product.
10. Access the print settings in your print application.
11. Select **Print Settings** from the pop-up menu.
12. Select **Plain Paper/Bright White Paper** or **Envelope** as the paper type setting.

13. Select the **Grayscale** option.
14. Click **Print** to print your document.

Parent topic: [Printing With Black Ink and Expended Color Cartridges](#)

Related tasks

[Selecting Basic Print Settings - Mac OS X](#)

[Cancelling Printing Using a Product Button](#)

Conserving Low Black Ink with Windows

The following window appears when black ink runs low and there is more color ink.

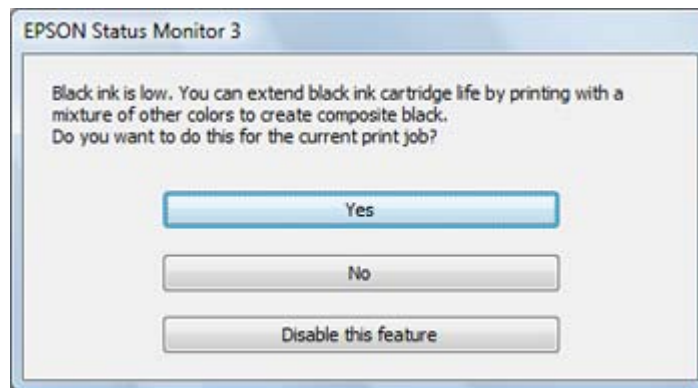

Note: The window appears only when you have selected **Plain Paper/Bright White Paper** as the paper type setting, and depends on other selected print settings. To use this feature, Epson Status Monitor must be enabled.

- Click **Yes** to use a mixture of color inks to create black, or **No** to continue using the remaining black ink for the document you are printing.
- Click **Disable this feature** to continue using the remaining black ink.

Note: If you disable this feature, it remains disabled until you reinstall the black ink cartridge.

Parent topic: [Replacing Ink Cartridges](#)

Adjusting Print Quality

If your print quality declines, you may need to run a utility to clean or align the print head.

If running these utilities does not solve the problem, you may need to replace the ink cartridges.

[Print Head Maintenance](#)

[Cleaning the Paper Path](#)

Related topics

[Replacing Ink Cartridges](#)

Print Head Maintenance

If your printouts become too light, or you see dark or light bands across them, you may need to clean the print head nozzles. Cleaning uses ink, so clean the nozzles only if print quality declines.

You can check for clogged nozzles before you clean them so you don't clean them unnecessarily.

Note: You cannot clean the print head if an ink cartridge is expended, and may not be able to clean it when a cartridge is low. You must replace the cartridge first.

[Print Head Nozzle Check](#)

[Print Head Cleaning](#)

[Print Head Alignment](#)

Parent topic: [Adjusting Print Quality](#)

Related topics

[Replacing Ink Cartridges](#)

Print Head Nozzle Check

You can print a nozzle check pattern to check for clogged nozzles.

[Checking the Nozzles Using the Product Control Panel](#)

[Checking the Nozzles Using a Computer Utility](#)

Parent topic: [Print Head Maintenance](#)

Checking the Nozzles Using the Product Control Panel

You can check the print head nozzles using the control panel on your product.

1. Load a few sheets of plain paper in the product.
2. Press the  **Menu** button.
3. Press the up or down arrow buttons to select **Maintenance** and press the **OK** button.

You see this screen:



4. Press the up or down arrow buttons to select **Nozzle Check** and press the **OK** button.
5. Press one of the  **Start** buttons.

After the nozzle pattern prints, you see this screen:

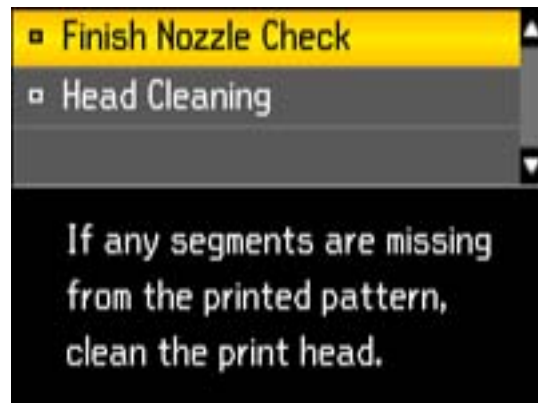

6. Check the printed pattern to see if there are gaps in the lines.

Print head is clean

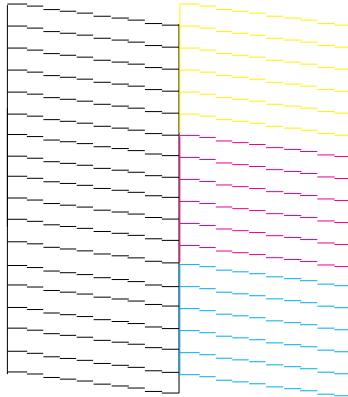

Print head needs cleaning

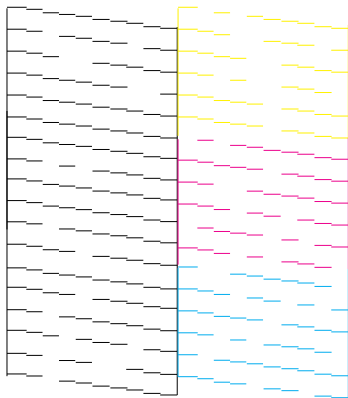

7. Do one of the following:
- If there are no gaps, select **Finish Nozzle Check** and press the **OK** button.
 - If there are gaps or the pattern is faint, select **Head Cleaning** and press the **OK** button to continue.

8. Follow the instructions on the screen to clean the print head, check the nozzles, and repeat the process as necessary.

If you don't see any improvement after cleaning the print head up to 4 times, leave the product turned on and wait at least 6 hours. Then try cleaning the print head again. If quality still does not improve, one of the ink cartridges may be old or damaged and needs to be replaced.

Parent topic: [Print Head Nozzle Check](#)

Checking the Nozzles Using a Computer Utility

You can check the print head nozzles using a utility on your Windows or Mac computer.

1. Load a few sheets of plain paper in the product.
2. Do one of the following:
 - **Windows:** Right-click the product icon in the Windows taskbar.
 - **Mac OS X 10.6/10.7/10.8:** In the Apple menu or the Dock, select **System Preferences**. Select **Print & Fax** or **Print & Scan**, select your product, and select **Options & Supplies**. Select **Utility** and select **Open Printer Utility**.
 - **Mac OS X 10.5:** In the Apple menu or the Dock, select **System Preferences**. Select **Print & Fax**, select your product, and select **Open Print Queue**. Select **Utility**.
3. Select **Nozzle Check**.

You see a window like this:

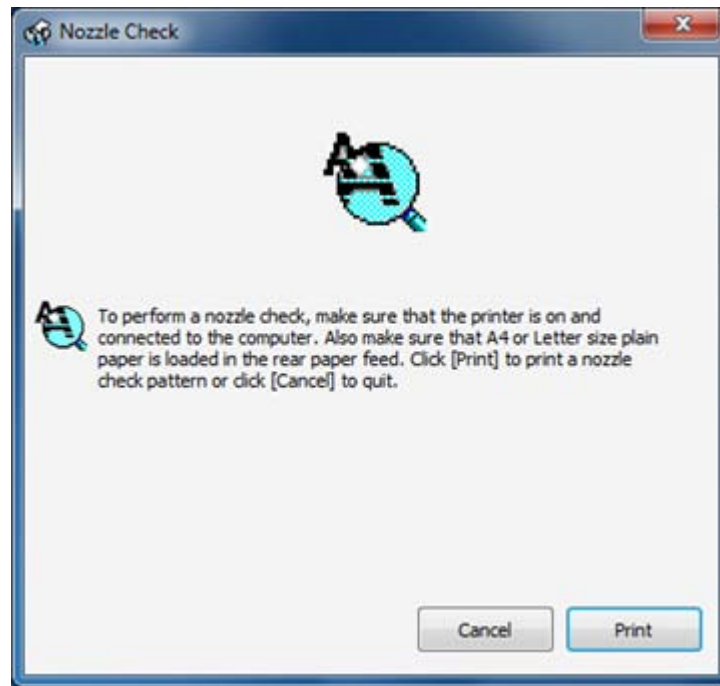

4. Click **Print**.
 5. Check the printed pattern to see if there are gaps in the lines.
- Print head is clean**

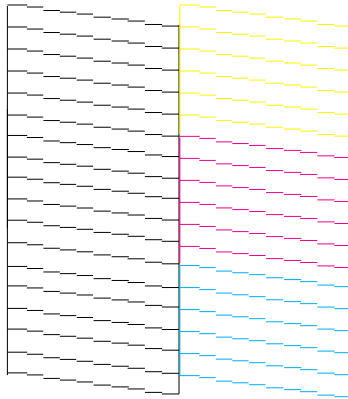

Print head needs cleaning

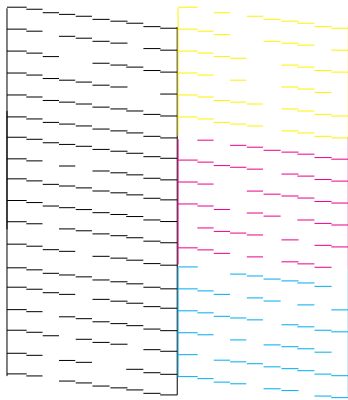

6. If there are no gaps, click **Finish**.

If there are gaps or the pattern is faint, clean the print head.

Parent topic: [Print Head Nozzle Check](#)

Related concepts

[Print Head Cleaning](#)

Print Head Cleaning

If print quality has declined and the nozzle check pattern indicates clogged nozzles, you can clean the print head.

Note: You cannot clean the print head if an ink cartridge is expended, and may not be able to clean it when a cartridge is low. You must replace the cartridge first.

[Cleaning the Print Head Using the Product Control Panel](#)

[Cleaning the Print Head Using a Computer Utility](#)

Parent topic: [Print Head Maintenance](#)

Related concepts

[Print Head Nozzle Check](#)

Related topics

[Replacing Ink Cartridges](#)

Cleaning the Print Head Using the Product Control Panel

You can clean the print head using the control panel on your product.

1. Load a few sheets of plain paper in the product.
2. Press the  **Menu** button.
3. Press the up or down arrow buttons to select **Maintenance** and press the **OK** button.

You see this screen:



4. Press the up or down arrow buttons to select **Head Cleaning** and press the **OK** button.
You see this screen:

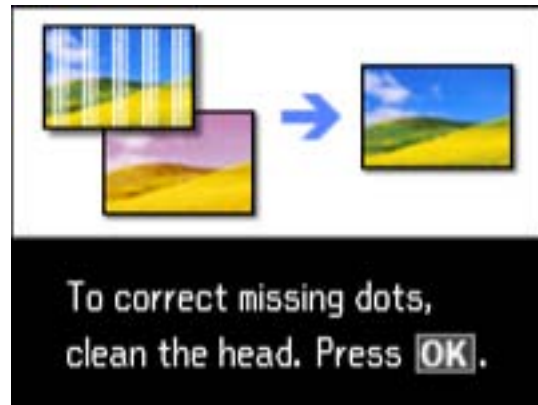

5. Press the **OK** button to begin the cleaning cycle.

Caution: Never turn off the product during a cleaning cycle or you may damage it.

The  power light flashes throughout the cleaning cycle and stays on green when the cleaning cycle is finished. You see this screen:

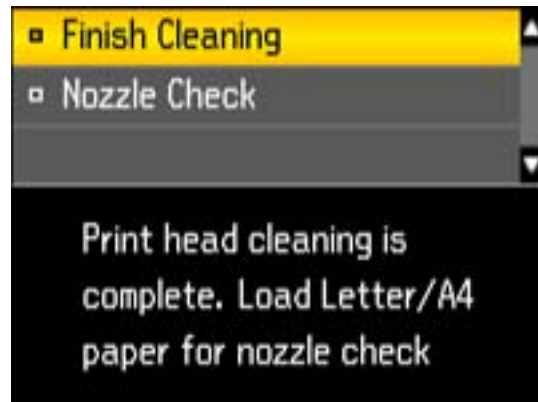

6. Press the up or down arrow buttons to select **Nozzle Check** and press the **OK** button.

7. Press one of the  **Start** buttons to run a nozzle check to confirm that the print head is clean.

If you don't see any improvement after cleaning the print head up to 4 times, leave the product turned on and wait at least 6 hours. Then try cleaning the print head again. If quality still does not improve, one of the ink cartridges may be old or damaged and needs to be replaced.

Parent topic: [Print Head Cleaning](#)

Related topics

[Replacing Ink Cartridges](#)

Cleaning the Print Head Using a Computer Utility

You can clean the print head using a utility on your Windows or Mac computer.

1. Load a few sheets of plain paper in the product.
2. Do one of the following:
 - **Windows:** Right-click the product icon in the Windows taskbar.
 - **Mac OS X 10.6/10.7/10.8:** In the Apple menu or the Dock, select **System Preferences**. Select **Print & Fax** or **Print & Scan**, select your product, and select **Options & Supplies**. Select **Utility** and select **Open Printer Utility**.
 - **Mac OS X 10.5:** In the Apple menu or the Dock, select **System Preferences**. Select **Print & Fax**, select your product, and select **Open Print Queue**. Select **Utility**.
3. Select **Head Cleaning**.

You see a window like this:

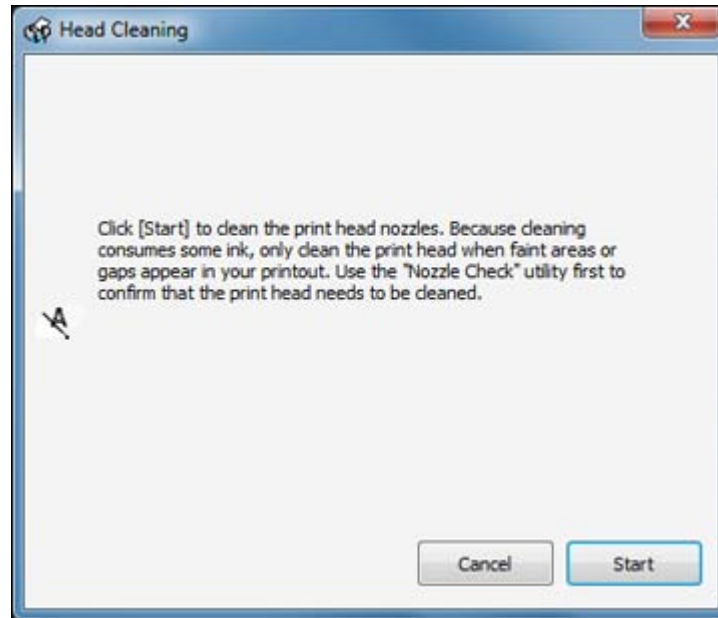

4. Click **Start** to begin the cleaning cycle.

The  power light flashes throughout the cleaning cycle and stays on when the cleaning cycle is finished.

Caution: Never turn off the product during a cleaning cycle or you may damage it.

5. When the  power light stops flashing and remains on, you can check to see if the nozzles are clean; click **Print Nozzle Check Pattern** and click **Print**.
6. Check the printed pattern to see if there are gaps in the lines.

Print head is clean

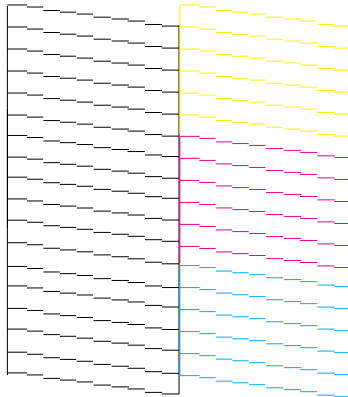

Print head needs cleaning

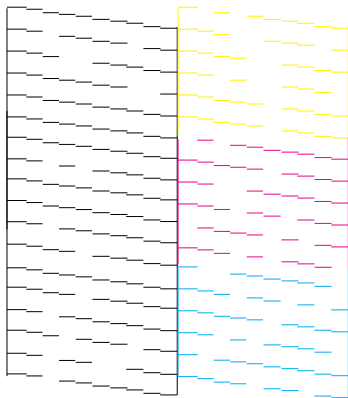

- If there are no gaps, click **Finish**.
- If there are gaps or the pattern is faint, click **Clean** to clean the print head again.

If you don't see any improvement after cleaning the print head up to 4 times, leave the product turned on and wait at least 6 hours. Then try cleaning the print head again. If quality still does not improve, one of the ink cartridges may be old or damaged and needs to be replaced.

Parent topic: [Print Head Cleaning](#)

Related topics

[Replacing Ink Cartridges](#)

Print Head Alignment

If your printouts become grainy or blurry, you notice misalignment of vertical lines, or you see dark or light horizontal bands, you may need to align the print head.

Note: Banding may also occur if your print head nozzles need cleaning.

[Aligning the Print Head Using the Product Control Panel](#)

[Aligning the Print Head Using a Computer Utility](#)

Parent topic: [Print Head Maintenance](#)

Related concepts

[Print Head Cleaning](#)

Aligning the Print Head Using the Product Control Panel

You can align the print head using the control panel on your product.

1. Load a few sheets of plain paper in the product.
2. Press the  **Menu** button.
3. Press the up or down arrow buttons to select **Maintenance** and press the **OK** button.

You see this screen:



4. Press the up or down arrow buttons to select **Head Alignment** and press the **OK** button.

You see this screen:



5. Press one of the **Start** buttons to print an alignment sheet.

Note: Do not cancel printing while you are printing a head alignment pattern.

You see this screen:



6. Check the printed pattern and press the up or down arrow buttons to choose the number representing the best printed pattern for each set. Press the **OK** button after each selection.

Parent topic: [Print Head Alignment](#)

Aligning the Print Head Using a Computer Utility

You can align the print head using a utility on your Windows computer or Mac.

1. Load a few sheets of plain paper in the product.
2. Do one of the following:
 - **Windows:** Right-click the product icon in the Windows taskbar.
 - **Mac OS X 10.6/10.7/10.8:** In the Apple menu or the Dock, select **System Preferences**. Select **Print & Fax** or **Print & Scan**, select your product, and select **Options & Supplies**. Select **Utility** and select **Open Printer Utility**.
 - **Mac OS X 10.5:** In the Apple menu or the Dock, select **System Preferences**. Select **Print & Fax**, select your product, and select **Open Print Queue**. Select **Utility**.
3. Select **Print Head Alignment**.
4. Click **Next**, then click **Print** to print an alignment sheet.

Note: Do not cancel printing while you are printing a head alignment pattern.

You see a window like this:

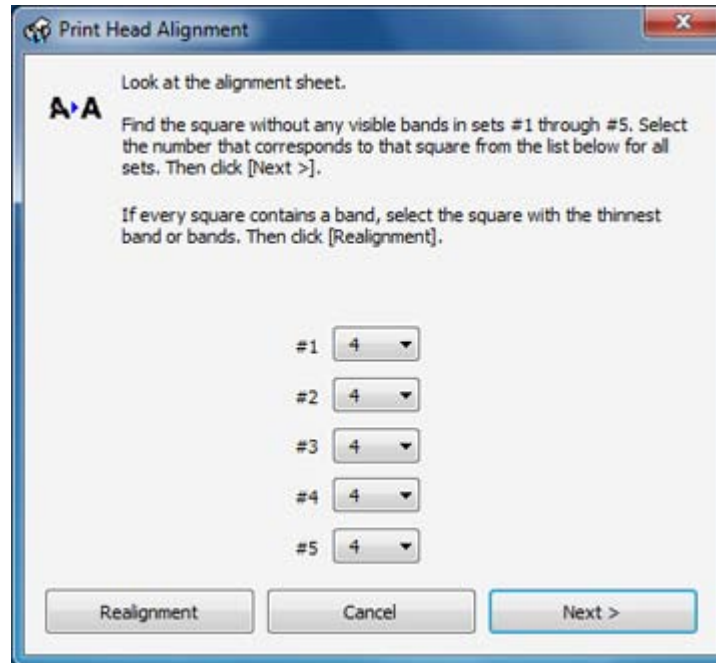

5. Check the printed pattern and follow the instructions on the screen to choose the number representing the best printed pattern for each set.
 - After choosing each pattern number, click **Next**.
 - If no patterns are aligned in one or more of the sets, choose the closest one in each set and click **Realignment**. Then print another alignment sheet and check it.

Note: Click **Skip** (where available) if you want to skip a particular alignment sheet.

6. When you are done, click **Finish**.

Parent topic: [Print Head Alignment](#)

Cleaning the Paper Path

If you see ink on the back of a printout, you can clean the paper path to remove any excess ink.

1. Load a few sheets of plain paper in the product.

2. Use the product control panel to make a copy, but without placing a document on the scanner glass.
3. Check the back of the ejected paper to see if it is clean.
4. Repeat as necessary until the paper comes out clean.

Parent topic: [Adjusting Print Quality](#)

Related topics

[Copying](#)

Cleaning and Transporting Your Product

See these sections if you need to clean or transport your product.

[Cleaning Your Product](#)

[Transporting Your Product](#)

Cleaning Your Product

To keep your product working at its best, you should clean it several times a year.

Close the output tray and paper support when you are not using the product to protect it from dust.

Caution: Do not use a hard brush, alcohol, or paint thinner to clean the product or you may damage it. Do not use oil or other lubricants inside the product or let water get inside it.

1. Turn off the product.
2. Unplug the power cable.
3. Disconnect any connected cables.
4. Remove all the paper.
5. Clean the scanner glass with a soft, lint-free cloth (microfiber is recommended), moistened with a little glass cleaner. If you see lines in your scans or copies, clean the left side of the glass carefully.

Caution: Do not spray glass cleaner directly on the glass and do not press the glass surface with any force.

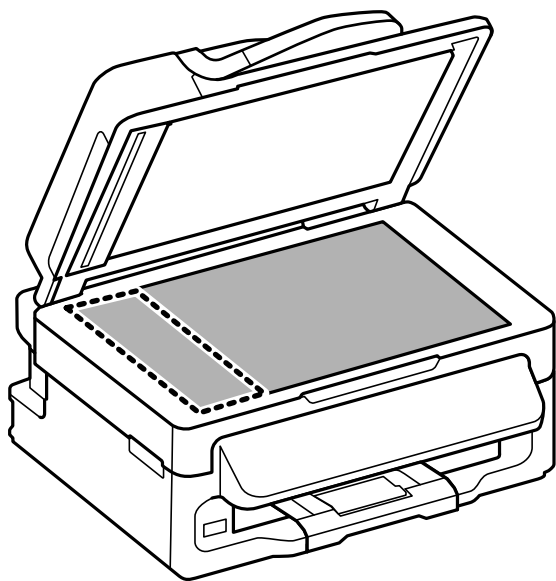

6. Open the ADF cover and use a soft, dry, lint-free cloth (microfiber is recommended) to clean the rollers and the interior of the ADF.

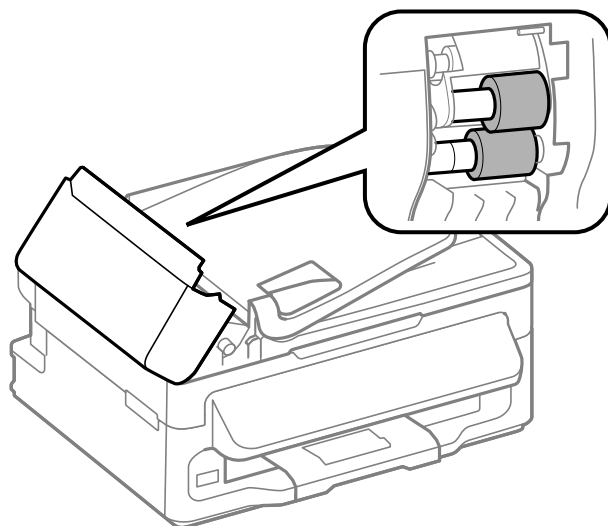

7. Clean the outer case and control panel with a soft, dry, lint-free cloth. Do not use liquid or chemical cleansers.

Parent topic: [Cleaning and Transporting Your Product](#)

Related tasks

[Cleaning the Paper Path](#)

Transporting Your Product

If you need to ship your product or transport it a long distance, prepare it for transportation as described here.

Caution: During transportation and storage, follow these guidelines:

- Avoid tilting the product, placing it vertically, or turning it upside down; otherwise ink may leak.
- Leave the ink cartridges installed. Removing the cartridges can dry out the print head and may prevent the product from printing.

1. Turn off the product.
2. Lift up the scanner unit and check to see if the ink cartridge holder is in the far right position (the home position). If not, turn on the product, wait for the ink cartridge holder to move, then turn the product off again.
3. Secure the ink cartridge holder to the case with tape.

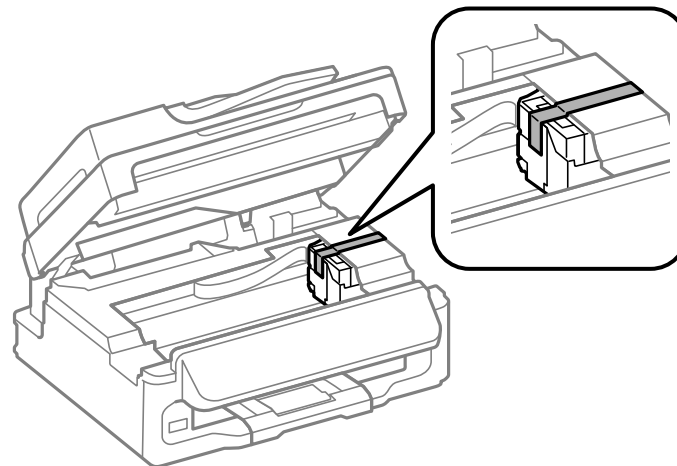

Caution: Do not place tape on the white flat cable inside the product; otherwise, you may damage your product.

4. Lower the scanner unit.
5. Remove all the paper from the product.
6. Unplug the power cable.
7. Disconnect any connected cables.
8. Close the output tray and paper support.
9. Place the product in its original packing materials, if possible, or use equivalent materials with cushioning around the product.

Keep the product level during transportation. Be sure to remove the tape from the ink cartridge holder before turning on your product. If print quality has declined when you print again, clean and align the print head.

Parent topic: [Cleaning and Transporting Your Product](#)

Related concepts

[Print Head Alignment](#)

[Print Head Cleaning](#)

Solving Problems

Check these sections for solutions to problems you may have using your product.

[Checking for Software Updates](#)

[Product Status Messages](#)

[Running a Product Check](#)

[Resetting Control Panel Defaults](#)

[Solving Setup Problems](#)

[Solving Network Problems](#)

[Solving Copying Problems](#)

[Solving Paper Problems](#)

[Solving Problems Printing from a Computer](#)

[Solving Page Layout and Content Problems](#)

[Solving Print Quality Problems](#)

[Solving Scanning Problems](#)

[Solving Scanned Image Quality Problems](#)

[Solving Faxing Problems](#)

[Cannot Transfer Files To or From a USB Flash Drive](#)

[When to Uninstall Your Product Software](#)

[Where to Get Help](#)

Checking for Software Updates

Periodically, it's a good idea to check Epson's support website for free updates to your product software. You can select **Download the Latest Software** from the Home screen of this manual or visit Epson's driver download site ([U.S. downloads](#) or [Canadian downloads](#)).

With Windows, your printer software automatically checks for updates. You can also manually update the software by selecting **Software Update** here:

- Right-clicking the product icon in the Windows taskbar
- On the **Maintenance** tab in the printer settings window
- On the **Start** screen (Windows 8) or in the **EPSON** program group under your product name (other Windows versions)

Parent topic: [Solving Problems](#)

Related tasks

[Changing Automatic Update Options](#)

Product Status Messages

You can often diagnose problems with your product by checking the messages on its LCD screen.

LCD screen message	Condition/solution
Paper jam	Paper is jammed in the product. Remove the jammed paper and follow the steps on the LCD screen to clear the error.
Paper jam in the ADF	Paper is jammed in the ADF or an object is blocking the hole in the front left corner of the product next to the scanner glass. Remove the object or jammed paper and follow the prompts on the LCD screen to clear any error messages.
Communication error	Make sure the computer is connected to your product and your software is installed correctly.
Printer error	Turn the product off. Make sure no paper is jammed in the product, then turn the product back on again. If the error continues, contact Epson for support.
Scanner error	Turn the product off and then back on again. If the error continues, contact Epson for support.
A fax error has occurred	
A printer's ink pad is nearing the end of its service life.	The ink pad is near the end of its service life. Contact Epson for support. (To continue printing, press one of the Start buttons.)
A printer's ink pad is at the end of its service life.	The ink pad is at the end of its service life. Turn off the product and contact Epson for support.
Cannot recognize USB device.	Make sure the USB device has been inserted correctly.
No dial tone	Make sure the phone cable is connected correctly and the phone line works. If you connected the product to a PBX (Private Branch Exchange) phone line or Terminal Adapter, turn off the Dial Tone Detection setting.
Recovery mode	An error has occurred during firmware updating. Connect your product using a USB cable and try updating the firmware again. If you still receive this error message, contact Epson for support.

Parent topic: [Solving Problems](#)

Related references

[Paper Jam Problems](#)

[Document Jams in the Automatic Document Feeder](#)

[Where to Get Help](#)

Related tasks

[Connecting a Telephone or Answering Machine](#)

Running a Product Check

Running a product check helps you determine if your product is operating properly.

1. Disconnect any interface cables connected to your product.
2. Load a few sheets of plain paper in the product.
3. Press the  **Menu** button.
4. Press the up or down arrow buttons to select **Maintenance** and press the **OK** button.

You see this screen:



5. Press the up or down arrow buttons to select **Nozzle Check** and press the **OK** button.
6. Press one of the  **Start** buttons.

After the nozzle pattern prints, you see this screen:

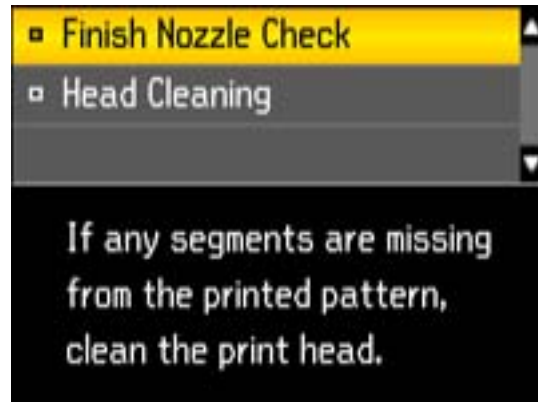

7. Do the following, depending on the results of the product check:
 - If the page prints and the nozzle check pattern is complete, the product is operating properly. Any operation problem you may have could be caused by your computer, cable, software, or selected settings. Check the other solutions in this book or try uninstalling and reinstalling your printer software.
 - If the page prints but the nozzle check pattern has gaps, clean or align the print head.
 - If the page does not print, the product may have a problem. Check the other solutions in this manual. If they do not work, contact Epson.

Parent topic: [Solving Problems](#)

Related concepts

[Print Head Alignment](#)

[Print Head Cleaning](#)

[When to Uninstall Your Product Software](#)

Related references

[Where to Get Help](#)

Resetting Control Panel Defaults

If you have a problem with settings on the product control panel, you can reset them to their factory defaults. You can choose which settings to reset or reset them all.

1. Press the  **Menu** button.
2. Press the up or down arrow buttons to select **Restore Default Settings** and press the **OK** button.

You see this screen:



3. Press the up or down arrow buttons to select one of these options and press the **OK** button.
 - **Fax Send/Receive Settings:** Restores all of the default fax settings on the **Send Settings**, **Receive Settings**, and **Communication** screens.
 - **Fax Data Settings:** Erases the speed dial list, group dial list, header, and fax log.
 - **Wi-Fi/Network Setting:** Restores all of the default network settings.
 - **All except Wi-Fi/Network & Fax Settings:** Restores all of the default settings on the control panel, except for the network and fax settings.
 - **All Settings:** Restores all of the default settings on the control panel.

You see a confirmation screen.
4. Select **Yes** and press the **OK** button to reset the selected settings. (Select **No** and press the **OK** button if you want to cancel the operation.)

Parent topic: [Solving Problems](#)

Solving Setup Problems

Check these sections if you have problems while setting up your product.

[Noise After Ink Installation](#)

[Software Installation Problems](#)

[Control Panel Setup Problems](#)

Parent topic: [Solving Problems](#)

Noise After Ink Installation

If you hear noises from your product after installing ink, check the following:

- The first time you install ink cartridges, the product must prime its print head. Wait until priming finishes before you turn off the product, or it may prime improperly and use excess ink the next time you turn it on. Your product is finished priming the print head when the ⏻ power light stops flashing.
- If the product's print head stops moving or making noise, and the charging process has not finished after approximately 5 minutes, turn off your product. Turn it back on and check to see if charging is still in progress. If it is still in progress, contact Epson for help.

Parent topic: [Solving Setup Problems](#)

Related topics

[Replacing Ink Cartridges](#)

Software Installation Problems

If you have problems while installing your product software, try these solutions:

- Make sure your product is turned on and any necessary cables are securely connected at both ends. If you still have problems installing software, disconnect the cable and carefully follow the instructions on the *Start Here* sheet. Also make sure your system meets the requirements for your operating system.
- Close any other programs, including screen savers and virus protection software, and install your product software again.
- In Windows, make sure your product is selected as the default printer and the correct port is shown in the printer properties.
- If you see any error message or your software does not install correctly in Windows, you may not have software installation privileges. Contact your System Administrator.

Parent topic: [Solving Setup Problems](#)

Related concepts

[When to Uninstall Your Product Software](#)

Related references

[Windows System Requirements](#)

[Mac System Requirements](#)

Control Panel Setup Problems

If you have problems setting up the control panel, try these solutions:

- To view LCD screen text in a different language, select a different language setting for the panel.
- To turn off the beep heard when you press a button, turn off the panel's sound setting. This also turns off the dialing sound for sending faxes.

Parent topic: [Solving Setup Problems](#)

Related tasks

[Changing LCD Screen Language](#)

[Turning Off Control Panel Sounds](#)

Solving Network Problems

Check these solutions if you have problems setting up or using your product on a network.

Note: Breakdown or repair of this product may cause loss of fax and network data and settings. Epson is not responsible for backing up or recovering data and settings during or after the warranty period. We recommend that you make your own backup or print out your fax and network data and settings.

[Product Cannot Connect to a Wireless Router or Access Point](#)

[Network Software Cannot Find Product on a Network](#)

[Product Does Not Appear in Mac OS X Printer Window](#)

[Cannot Print Over a Network](#)

[Cannot Scan Over a Network](#)

[Printing a Network Status Sheet](#)

Parent topic: [Solving Problems](#)

Product Cannot Connect to a Wireless Router or Access Point

If your product has trouble finding or connecting to a wireless router or access point, try these solutions :

- Make sure to place your product within contact range of your router or access point.

Note: Avoid placing your product near a microwave oven, 2.4 GHz cordless phone, or large metal object, such as a filing cabinet.

- Verify that your router or access point is operating correctly by connecting to it from your computer or another device.

- You may need to disable the firewall and any anti-virus software on your wireless router or access point.
- Check to see if access restrictions, such as MAC address filtering, are set on the router or access point. If access restrictions are set, add your product's MAC address to your router's address list. To obtain your product's MAC address, print a network status sheet. Then follow the instructions in your router or access point documentation to add the address to the list.
- If your router or access point does not broadcast its network name (SSID), follow the instructions that came with your product to enter your wireless network name manually.
- If your router or access point has security enabled, determine the kind of security it is using and any required password or passphrase for connection. Then make sure to enter the exact WEP key or WPA passphrase correctly.

Parent topic: [Solving Network Problems](#)

Network Software Cannot Find Product on a Network

If EpsonNet Setup cannot find your product on a network, try these solutions:

- Make sure your product is turned on and connected to your network. Verify connection using your product control panel.
- If necessary, reinstall your product software and try running EpsonNet Setup again.

Parent topic: [Solving Network Problems](#)

Related concepts

[When to Uninstall Your Product Software](#)

Product Does Not Appear in Mac OS X Printer Window

If your product does not appear in the Mac OS X printer window, try these solutions:

- Turn your product off, wait 30 seconds, then turn it back on again.
- If you are connecting the product wirelessly via EpsonNet Setup and the WiFi light on your product is not solid green, make sure your product software was installed correctly. If necessary, reinstall your software.

Parent topic: [Solving Network Problems](#)

Cannot Print Over a Network

If you cannot print over a network, try these solutions:

- Make sure that your product is turned on.

- Make sure you install your product's network software as described in your product documentation.
- Print a network status sheet and verify that the network settings are correct. If the network status is **Disconnected**, check any cable connections and turn your product off and then on again.
- If you are using TCP/IP, make sure the product's IP address is set correctly for your network. If your network does not assign IP addresses using DHCP, set the IP address manually.
- If network printing is slow, print a network status sheet and check the signal strength. If it is poor, place your product closer to your router or access point.

Note: Avoid placing your product near a microwave oven, 2.4 GHz cordless phone, or large metal object, such as a filing cabinet.

- Check your wired LAN router or access point to see if the LED for the port to which your product is connected is on or flashing . If the link LED is off, try the following:
 - Make sure the Ethernet cable is securely connected to your product and to your router, access point, switch, or hub.
 - Try connecting your product to a different port or a different router, access point, switch, or hub.
 - Try connecting with a different Ethernet cable.
 - Try printing to your product from another computer on the network.
- If you are connecting the product via EpsonNet Setup and the WiFi light on your product is not solid green , make sure your product software was installed correctly. If necessary, reinstall your software.

Parent topic: [Solving Network Problems](#)

Related tasks

[Printing a Network Status Sheet](#)

Cannot Scan Over a Network

If you cannot start Epson Scan for scanning over a network, try these solutions:

- If you cannot scan from your product control panel, make sure you restarted your computer after installing the product software. Make sure the Event Manager program is not being blocked by your firewall or security software.
- If you are scanning a large original at a high resolution, a network communication error may occur. Try scanning again at a lower resolution.
- If network communication was interrupted while starting Epson Scan, exit Epson Scan, wait a few seconds, and restart it. If Epson Scan cannot restart, turn off your product, turn it back on, and try restarting Epson Scan again.

- Check the connection setting and test the connection using Epson Scan Settings:
 - Windows 8:** Navigate to the **Start** screen and select **EPSON Scan Settings**. Make sure the **Connection** setting is set to **Network**, then click the **Test** button.
 - Windows (other versions):** Click  or **Start > All Programs** or **Programs > EPSON > EPSON Scan > EPSON Scan Settings**. Make sure the **Connection** setting is set to **Network**, then click the **Test** button.
 - Mac OS X:** Open the **Applications** folder, click **Epson Software**, and click **EPSON Scan Settings**. Make sure the **Connection** setting is set to **Network**, then click the **Test** button.
- Make sure the option selected as the **Timeout Setting** in the Epson Scan Settings program is long enough to complete scanning over a network.
- You may need to disable the firewall and any anti-virus software on your wireless router or access point.

Note: With Mac OS X 10.6, 10.7, or 10.8, in addition to scanning with Image Capture, you can download and install Epson Scan scanning software. Epson Scan provides additional image adjustment and photo correction features for enhancing scanned images, and provides an interface for TWAIN-compliant OCR scanning software, such as ABBYY FineReader. To download Epson Scan, visit Epson's driver download site ([U.S. downloads](#) or [Canadian downloads](#)).



Parent topic: [Solving Network Problems](#)

Related topics

[Scanning](#)

Printing a Network Status Sheet

You can print a network status sheet to help you determine the causes of any problems you may have using your product on a network.

1. Press the  **Menu** button.
2. Press the up or down arrow buttons to select **Wi-Fi/Network Settings** and press the **OK** button.
3. Press the up or down arrow buttons to select **Confirm Wi-Fi/Network Settings** and press the **OK** button.
4. Press one of the  **Start** buttons twice to print the network status sheet.
(Press the  **Stop/Reset** button if you want to cancel the operation.)

Examine the settings shown on the network status sheet to diagnose any problems you have.

Parent topic: [Solving Network Problems](#)

Solving Copying Problems

Check these solutions if you have problems copying with your product.

[Product Makes Noise, But Nothing Copies](#)

[Product Makes Noise When It Sits for a While](#)

Parent topic: [Solving Problems](#)

Product Makes Noise, But Nothing Copies

If your product makes a noise, but nothing copies, try these solutions:

- Run a nozzle check to see if any of the print head nozzles are clogged. Then clean the print head, if necessary.
- If the nozzle check page does not print, but the product's power is on, make sure your product software is installed correctly.
- Make sure your product is level (not tilted).

Parent topic: [Solving Copying Problems](#)

Related concepts

[Print Head Cleaning](#)

[Print Head Nozzle Check](#)

Product Makes Noise When It Sits for a While

Your product is performing routine maintenance. This is normal.

Parent topic: [Solving Copying Problems](#)

Solving Paper Problems

Check these sections if you have problems using paper with your product.

[Paper Feeding Problems](#)

[Paper Jam Problems](#)

[Document Jams in the Automatic Document Feeder](#)

[Paper Ejection Problems](#)

Parent topic: [Solving Problems](#)

Paper Feeding Problems

If you have problems feeding paper, try these solutions:

- If paper does not feed for printing, remove it. Then reload it in the sheet feeder against the right side and beneath the tab. Slide the edge guide against the edge of the paper, making sure that the paper stack is not above the arrow mark on the edge guide.
- If multiple pages feed at once, remove the paper, fan the edges to separate the sheets, and reload it.
- If paper jams when you load only one or two sheets, try loading more sheets at a time. Do not load more than the recommended number of sheets.
- If paper jams when you print on both sides of the paper, try loading fewer sheets.
- For best results, follow these guidelines:
 - Use new, smooth, high-quality paper that is not curled, creased, old, too thin, or too thick.
 - Load paper in the sheet feeder printable side up.
 - Follow any special loading instructions that came with the paper.

Parent topic: [Solving Paper Problems](#)

Related references

[Paper Jam Problems](#)

[Document Jams in the Automatic Document Feeder](#)

[Paper Loading Capacity](#)

Related topics

[Loading Paper](#)

Paper Jam Problems

If you have problems with paper jams, try these solutions:

1. Cancel the print job from your computer, if necessary.
2. Gently pull out any jammed paper from the output tray and sheet feeder.
3. Lift up the scanner unit.

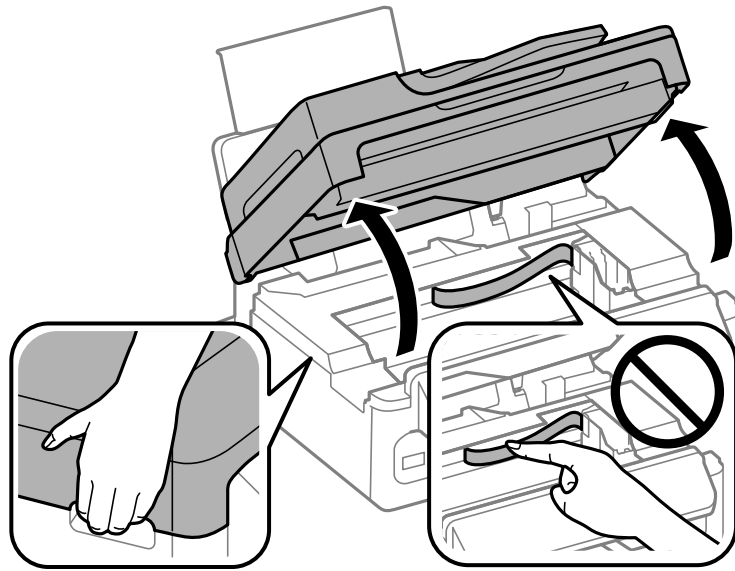

Caution: Do not touch the flat white cable inside the printer.

Caution: Do not lift up the scanner unit when the document cover is open.

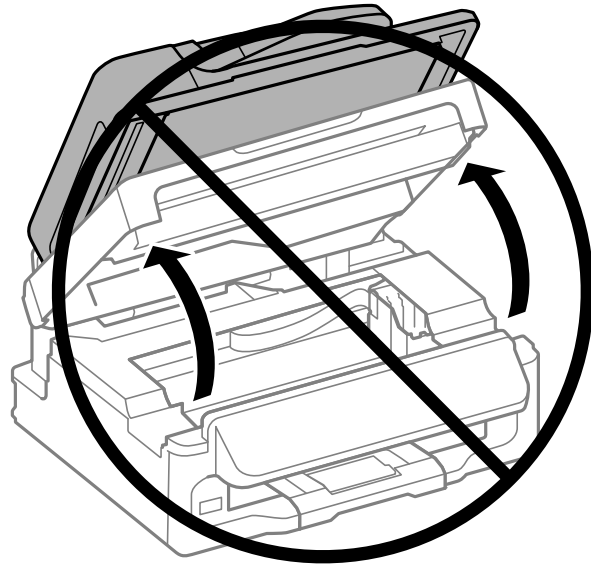

4. Remove any jammed paper or torn pieces.

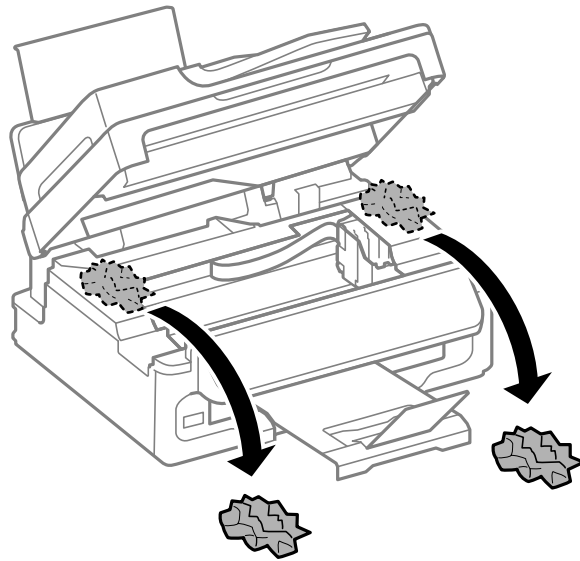

Caution: Do not touch any buttons on the control panel while your hands are inside the product.

5. Lower the scanner unit.
6. Follow the steps on the LCD screen to resume printing.
7. Carefully follow all paper loading instructions when you load new paper.

Parent topic: [Solving Paper Problems](#)

Related references

[Document Jams in the Automatic Document Feeder](#)

Related topics

[Loading Paper](#)

Document Jams in the Automatic Document Feeder

If you have problems with document jams in the automatic document feeder (ADF), try these solutions:

1. Remove your originals from the ADF.
2. Open the ADF cover.

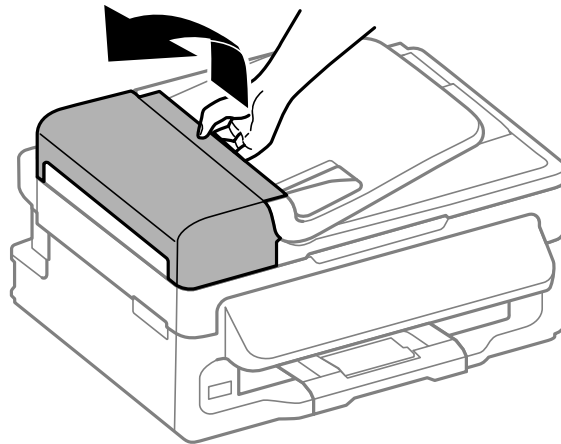

3. Remove any jammed paper.

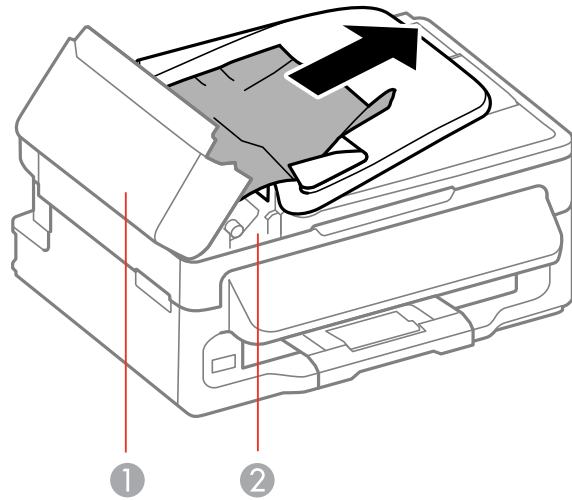

- 1 ADF cover
- 2 Paper feeder

Caution: Do not remove paper jammed inside the ADF without opening the cover or you could damage the ADF.

4. Leave the ADF cover open, then lift the paper feeder.

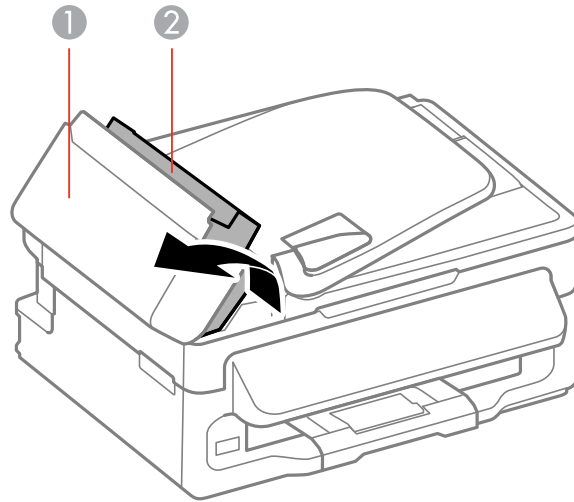

- 1 ADF cover
- 2 Paper feeder

5. Remove any jammed paper or torn pieces.

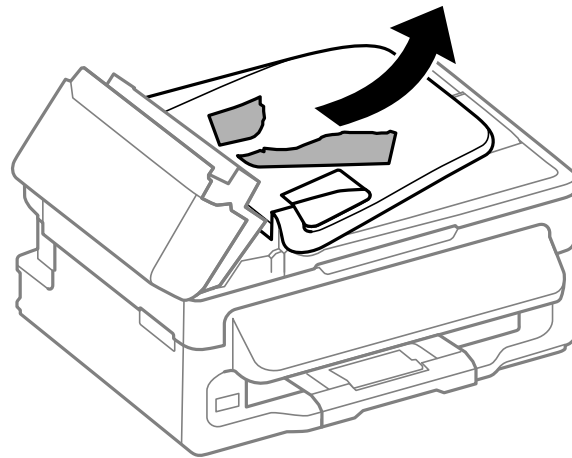

6. Lower the paper feeder (but don't close the ADF cover).
7. Raise the ADF input tray.

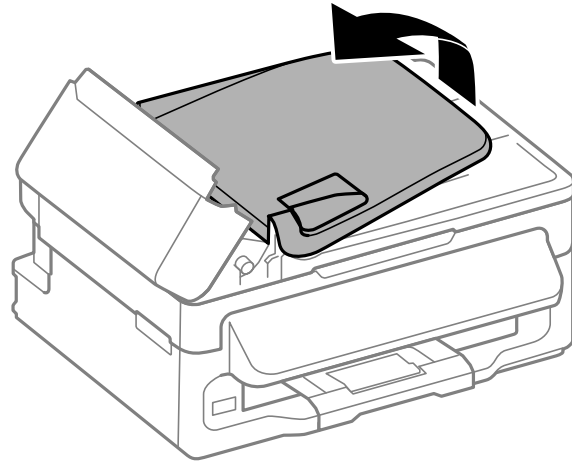

8. Carefully remove any jammed paper.

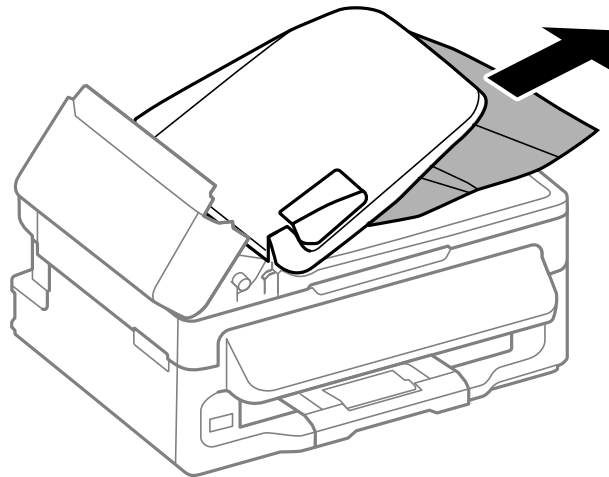

9. Lower the ADF input tray and reload your originals.

Caution: Make sure you do not load the ADF beyond its capacity for your paper size. Also make sure the originals you load are not bent, folded, or curled and do not have tape, staples, or other materials that could obstruct the feeder.

10. Follow the prompts on the LCD screen to clear any error messages.

Parent topic: [Solving Paper Problems](#)

Paper Ejection Problems

If you have problems with paper ejecting properly, try these solutions:

- If paper does not eject fully, you may have set the wrong paper size. Cancel printing to eject the paper. Select the correct paper size when you reprint.
- If paper is wrinkled when it ejects, it may be damp or too thin. Load new paper and be sure to select the correct paper type setting when you reprint.

Parent topic: [Solving Paper Problems](#)

Related references

[Paper Jam Problems](#)

[Document Jams in the Automatic Document Feeder](#)

[Paper or Media Type Settings](#)

Related tasks

[Cancelling Printing Using a Product Button](#)

Related topics

[Loading Paper](#)

Solving Problems Printing from a Computer

Check these sections if you have problems while printing from your computer.

[Nothing Prints](#)

[Product Icon Does Not Appear in Windows Taskbar](#)

[Error After Cartridge Replacement](#)

[Printing is Slow](#)

Parent topic: [Solving Problems](#)

Nothing Prints

If you have sent a print job and nothing prints, try these solutions:

- Make sure your product is turned on.
- Make sure any interface cables are connected securely at both ends.
- If you connected your product to a USB hub, make sure it is a first-tier hub. If it still does not print, connect your product directly to your computer instead of the hub.
- Run a product check to see if a test page prints. If the test page prints, check to see if your product software is installed correctly.
- In Windows, make sure your product is selected as the default printer.
- In Windows, clear any stalled print jobs from the Windows Spooler:
 - **Windows 8:** Navigate to the **Start** screen, right-click the screen, and select **All apps**. Select **Control Panel > Hardware and Sound > Devices and Printers**. Right-click your product name, select **See what's printing**, and select your product name again if necessary. Right-click the stalled print job, click **Cancel**, and click **Yes**.
 - **Windows 7:** Click  and select **Devices and Printers**. Right-click your product name, select **See what's printing**, and select your product name again, if necessary. Right-click the stalled print job, click **Cancel**, and click **Yes**.
 - **Windows Vista:** Click  and select **Control Panel**. Click **Printer** under **Hardware and Sound**, right-click your product name, and select **Open**. Right click the stalled print job, click **Cancel**, and click **Yes**.
 - **Windows XP:** Click **Start** and select **Printers and Faxes**. (Or open the **Control Panel**, select **Printers and Other Hardware**, if necessary, and select **Printers and Faxes**.) Right-click your product name, select **Open**, right-click the stalled print job, click **Cancel**, and click **Yes**.



Parent topic: [Solving Problems Printing from a Computer](#)

Related tasks

[Running a Product Check](#)

Product Icon Does Not Appear in Windows Taskbar

If you do not see your product icon in the Windows taskbar, first try restarting your computer. If that does not work, try this solution:

1. Do one of the following:
 - **Windows 8:** Navigate to the **Start** screen, right-click the screen and select **All apps**. Select **Control Panel > Hardware and Sound > Devices and Printers**.
 - **Windows 7:** Click  and select **Devices and Printers**.
 - **Windows Vista:** Click , select **Control Panel**, and click **Printer** under **Hardware and Sound**.
 - **Windows XP:** Click **Start** and select **Printers and Faxes**. (Or open the **Control Panel**, select **Printers and Other Hardware**, if necessary, and **Printers and Faxes**.)
2. Right-click your product name, select **Printing Preferences**, and select your product name again if necessary.
3. Click the **Maintenance** tab.
4. Click the **Extended Settings** button.
5. Select **Enable EPSON Status Monitor 3**, then click **OK**.
6. Click the **Monitoring Preferences** button.
7. Click the **Shortcut Icon** box.
8. Click **OK** to close the open program windows.

Parent topic: [Solving Problems Printing from a Computer](#)

Error After Cartridge Replacement

If you see an error light or error message after you replace an ink cartridge, follow these steps:

1. Make sure the print head is in the ink cartridge replacement position. (The ink cartridge holder should be beneath the cutout in the product case, allowing access to the cartridges.)

Note: If the print head is not in the ink cartridge replacement position, follow the instructions on replacing an ink cartridge in this manual to move it.

2. Remove and reinsert the ink cartridge you replaced, making sure to push it all the way into its slot.
3. Complete the ink cartridge installation steps.

Parent topic: [Solving Problems Printing from a Computer](#)

Related topics

[Replacing Ink Cartridges](#)

Printing is Slow

If printing becomes slow, try these solutions:

- Make sure your system meets the requirements for your operating system. If you are printing a high-resolution image, you may need more than the minimum requirements. If necessary, increase your system's memory.
- If you are using Windows 7, close the **Devices and Printers** window before you print.
- Clear space on your hard drive or run a defragmentation utility to free up existing space.
- Close any programs you are not using when you print.
- If your product is connected to a USB hub, connect it directly to your computer instead.
- If printing becomes slower after printing continuously for a long time, the product may have automatically slowed down to protect the print mechanism from overheating or becoming damaged. Let the product rest with the power on for 30 minutes, then try printing again.

For the fastest printing, select the following settings in your product software:

- Make sure the paper type setting matches the type of paper you loaded.
- Turn on any high speed settings in your product software.
- Select a lower print quality setting.
- **Windows:** Click the **Maintenance** tab, select **Extended Settings**, and select the following settings:
 - **High Speed Copies**
 - **Always spool RAW datatype**
 - **Page Rendering Mode**
 - **Print as Bitmap**

Parent topic: [Solving Problems Printing from a Computer](#)

Related references

[Paper or Media Type Settings](#)

[Windows System Requirements](#)

[Mac System Requirements](#)

Related tasks

[Selecting Basic Print Settings - Windows](#)

Solving Page Layout and Content Problems

Check these sections if you have problems with the layout or content of your printed pages.

[Inverted Image](#)

[Too Many Copies Print](#)

[Blank Pages Print](#)

[Incorrect Margins on Printout](#)

[Border Appears on Borderless Prints](#)

[Incorrect Characters Print](#)

[Incorrect Image Size or Position](#)

[Slanted Printout](#)

Parent topic: [Solving Problems](#)

Inverted Image

If your printed image is inverted unexpectedly, try these solutions:

- Turn off any mirror or inversion settings in your printing application.
- Turn off the **Mirror Image**, **Flip horizontally**, or **Reverse page orientation** settings in your printer software. (This option has different names, depending on your operating system version.)

Note: Leave these options turned on when you print on Epson Iron-on Cool Peel Transfer paper, if available for your product.

Parent topic: [Solving Page Layout and Content Problems](#)

Related tasks

[Selecting Additional Layout and Print Options - Windows](#)

[Selecting Basic Print Settings - Mac OS X](#)

Too Many Copies Print

Make sure that the **Copies** setting in your printing program or printer software is not set for multiple copies.

Parent topic: [Solving Page Layout and Content Problems](#)

Related tasks

[Selecting Basic Print Settings - Windows](#)

[Selecting Basic Print Settings - Mac OS X](#)

Blank Pages Print

If blank pages print unexpectedly, try these solutions:

- Make sure you selected the correct paper size settings in your printing program and printer software.
- If a blank page exists in a document you are printing and you want to skip printing it, select the **Skip Blank Page** setting in your printer software.
- Run a print head nozzle check to see if any of the nozzles are clogged. Then clean the print head, if necessary.
- Make sure your product is selected as the printer in your printing program.

Parent topic: [Solving Page Layout and Content Problems](#)

Related concepts

[Print Head Cleaning](#)

[Print Head Nozzle Check](#)

Related tasks

[Selecting Basic Print Settings - Windows](#)

[Selecting Basic Print Settings - Mac OS X](#)

[Selecting Printing Preferences - Mac OS X](#)

Incorrect Margins on Printout

If your printed page has incorrect margins, try these solutions:

- Make sure you selected the correct paper size settings in your printing program and printer software.
- Make sure you selected the correct margins for your paper size in your printing program.
- Make sure your paper is positioned correctly for feeding into the printer.

You can use the preview option in your printer software to check your margins before you print.

Parent topic: [Solving Page Layout and Content Problems](#)

Related tasks

[Selecting Basic Print Settings - Windows](#)

[Selecting Basic Print Settings - Mac OS X](#)

Related topics

[Loading Paper](#)

Border Appears on Borderless Prints

If you see a border on borderless prints, try these solutions:

- Make sure you are printing on a compatible borderless paper type and size.

Note: Do not select a custom paper size for borderless prints.

- **Windows:** Make sure you selected the **Borderless** setting in your printer software.
- **Mac OS X:** Make sure you selected the **Borderless** checkbox or a paper size with a **Borderless** option in your printer software.
- Adjust the **Expansion** setting to adjust the amount of image expansion on the edges of borderless prints.
- Make sure the image size and the paper size are set correctly; if the image is small, the enlargement may not be enough to cover the paper.

Parent topic: [Solving Page Layout and Content Problems](#)

Related references

[Borderless Paper Type Compatibility](#)

Related tasks

[Selecting Basic Print Settings - Windows](#)



[Selecting Basic Print Settings - Mac OS X](#)

[Selecting Page Setup Settings - Mac OS X](#)

Incorrect Characters Print

If incorrect characters appear in your prints, try these solutions before reprinting:

- Make sure any cables are securely connected at both ends.
- In Windows, delete all print jobs from the Windows Spooler:
 - **Windows 8:** Navigate to the **Start** screen, right-click the screen, and select **All apps**. Select **Control Panel > Hardware and Sound > Devices and Printers**. Right-click your product name, select **See what's printing**, and select your product name again, if necessary. Right-click the stalled print job, click **Cancel**, and click **Yes**.

- **Windows 7:** Click  and select **Devices and Printers**. Right-click your product name, select **See what's printing**, and select your product name again, if necessary. Right-click the stalled print job, click **Cancel**, and click **Yes**.
- **Windows Vista:** Click  and select **Control Panel**. Click **Printer** under **Hardware and Sound**, right-click your product name, and select **Open**. Right click the stalled print job, click **Cancel**, and click **Yes**.
- **Windows XP:** Click **Start** and select **Printers and Faxes**. (Or open the **Control Panel**, select **Printers and Other Hardware** if necessary, and select **Printers and Faxes**.) Right-click your product name, select **Open**, right-click the stalled print job, click **Cancel**, and click **Yes**.
- Make sure your product is selected as the printer in your printing program.
- If your product is connected to a USB hub, connect it directly to your computer instead.

Parent topic: [Solving Page Layout and Content Problems](#)

Related tasks

[Selecting Basic Print Settings - Windows](#)

[Selecting Basic Print Settings - Mac OS X](#)

Incorrect Image Size or Position

If your printed image is the wrong size or in the wrong position, try these solutions:

- Make sure you selected the correct paper size and layout settings in your printing program and printer software.
- Make sure your paper is positioned correctly for feeding into the printer.

You can use the preview option in your printer software to check your margins before you print.

Parent topic: [Solving Page Layout and Content Problems](#)

Related tasks

[Selecting Basic Print Settings - Windows](#)

[Selecting Additional Layout and Print Options - Windows](#)

[Selecting Basic Print Settings - Mac OS X](#)

[Selecting Print Layout Options - Mac OS X](#)

Related topics

[Loading Paper](#)

Slanted Printout

If your printouts are slanted, try these solutions:

- Slide the edge guide against the edge of the paper.
- Select a higher print quality setting in your printer software.
- Align the print head.
- Make sure the product is not printing while tilted or at an angle.

Parent topic: [Solving Page Layout and Content Problems](#)

Related concepts

[Print Head Alignment](#)

Related tasks

[Selecting Basic Print Settings - Windows](#)

[Selecting Basic Print Settings - Mac OS X](#)

Related topics

[Loading Paper](#)

Solving Print Quality Problems

Check these sections if your printouts have problems with print quality, but your image looks fine on your computer screen.

[White or Dark Lines in Printout](#)

[Blurry or Smearred Printout](#)

[Faint Printout or Printout Has Gaps](#)

[Grainy Printout](#)

[Incorrect Colors](#)

Parent topic: [Solving Problems](#)

Related topics

[Solving Scanned Image Quality Problems](#)

White or Dark Lines in Printout

If you notice white or dark lines in your prints (also called banding), try these solutions before you reprint:

- Run a nozzle check to see if any of the print head nozzles are clogged. Then clean the print head, if necessary.

- Make sure the paper type setting matches the type of paper you loaded.
- Make sure you loaded the printable side of the paper correctly for your product.
- Turn off any high speed settings in your product software.
- Align the print head.
- You may need to replace the ink cartridges.

Parent topic: [Solving Print Quality Problems](#)

Related concepts

[Print Head Cleaning](#)

[Print Head Nozzle Check](#)

[Print Head Alignment](#)

Related references

[Paper or Media Type Settings](#)

Related tasks

[Selecting Basic Print Settings - Windows](#)

[Selecting Additional Layout and Print Options - Windows](#)

[Selecting Basic Print Settings - Mac OS X](#)

[Selecting Printing Preferences - Mac OS X](#)

Related topics

[Replacing Ink Cartridges](#)

Blurry or Smearred Printout

If your printouts are blurry or smearred, try these solutions:

- Make sure your paper is not damp, curled, old, or loaded incorrectly in your product.
- Use a support sheet with special paper, or load special paper one sheet at a time.
- Make sure your paper meets the specifications for your product.
- Use Epson papers to ensure proper saturation and absorption of genuine Epson inks.
- Make sure the paper type setting in your product software matches the type of paper you loaded.
- Remove each sheet from the output tray as it is printed.
- Avoid handling printouts on glossy paper right after printing to allow the ink to set.
- Turn off any high speed settings in your product software.

- If you print on both sides of a sheet of paper, smudges may appear on the reverse side of heavily saturated or dark images. If one side of a sheet will contain a lighter image or text, print that side first.
- Run a nozzle check to see if any of the print head nozzles are clogged. Then clean the print head, if necessary.
- Align the print head.
- Clean the paper path.

Note: Your product will not operate properly while tilted at an angle. Place it on a flat, stable surface that extends beyond the base of the product in all directions.

Parent topic: [Solving Print Quality Problems](#)

Related concepts

[Print Head Cleaning](#)

[Print Head Alignment](#)

Related references

[Paper or Media Type Settings](#)

[Paper Specifications](#)

[Available EPSON Papers](#)

Related tasks

[Selecting Basic Print Settings - Windows](#)

[Selecting Additional Layout and Print Options - Windows](#)

[Selecting Basic Print Settings - Mac OS X](#)

[Selecting Printing Preferences - Mac OS X](#)

[Cleaning the Paper Path](#)

Related topics

[Loading Paper](#)

Faint Printout or Printout Has Gaps

If your printouts are faint or have gaps, try these solutions:

- Run a nozzle check to see if any of the print head nozzles are clogged. Then clean the print head, if necessary.
- The ink cartridges may be old or low on ink, and you may need to replace them.
- Make sure the paper type setting matches the type of paper you loaded.

- Make sure your paper is not damp, curled, old, or loaded incorrectly in your product.
- Align the print head.
- Clean the paper path.

Parent topic: [Solving Print Quality Problems](#)

Related concepts

[Print Head Cleaning](#)

[Print Head Nozzle Check](#)

[Print Head Alignment](#)

Related references

[Paper or Media Type Settings](#)

Related tasks

[Selecting Basic Print Settings - Windows](#)

[Selecting Basic Print Settings - Mac OS X](#)

[Cleaning the Paper Path](#)

Related topics

[Loading Paper](#)

[Replacing Ink Cartridges](#)

Grainy Printout

If your printouts are grainy, try these solutions:

- Make sure you loaded the printable side of the paper correctly for your product.
- Select a higher print quality setting and turn off any high speed settings in your product software.
- Run a nozzle check to see if any of the print head nozzles are clogged. Then clean the print head, if necessary.
- Align the print head.
- You may need to increase the image resolution or print a smaller size; see your software documentation.

Parent topic: [Solving Print Quality Problems](#)

Related concepts

[Print Head Cleaning](#)

[Print Head Nozzle Check](#)

[Print Head Alignment](#)

Related tasks

[Selecting Basic Print Settings - Windows](#)

[Selecting Additional Layout and Print Options - Windows](#)

[Selecting Basic Print Settings - Mac OS X](#)

[Selecting Printing Preferences - Mac OS X](#)

Related topics

[Loading Paper](#)

Incorrect Colors

If your printouts have incorrect colors, try these solutions:

- Make sure the **Black/Grayscale** or **Grayscale** setting is not selected in your printer software.
- Run a nozzle check to see if any of the print head nozzles are clogged. Then clean the print head, if necessary.
- The ink cartridges may be old or low on ink, and you may need to replace them.
- Your printed colors can never exactly match your on-screen colors. However, you can use a color management system to get as close as possible. Try using the color management options in your printer software.
- For best results, use genuine Epson ink and paper.

Parent topic: [Solving Print Quality Problems](#)

Related concepts

[Print Head Cleaning](#)

[Print Head Nozzle Check](#)

Related references

[Available EPSON Papers](#)

Related tasks

[Selecting Basic Print Settings - Windows](#)

[Selecting Additional Layout and Print Options - Windows](#)

[Selecting Basic Print Settings - Mac OS X](#)

[Managing Color - Mac OS X](#)

Related topics

[Replacing Ink Cartridges](#)

Solving Scanning Problems

Check these solutions if you have problems scanning with your product.

[Scanning Software Does Not Operate Correctly](#)

[Cannot Start Epson Scan](#)

Parent topic: [Solving Problems](#)

Scanning Software Does Not Operate Correctly

If your scanning software does not operate correctly, try these solutions:

- Make sure your computer has adequate memory and meets the system requirements for your operating system.
- Make sure your computer is not running in a power-saving mode, such as sleep or standby. If so, wake your system and restart your scanning software.
- If you upgraded your operating system but did not reinstall your scanning software, try reinstalling it.

Note: With Mac OS X 10.6, 10.7, or 10.8, in addition to scanning with Image Capture, you can download and install Epson Scan scanning software. Epson Scan provides additional image adjustment and photo correction features for enhancing scanned images, and provides an interface for TWAIN-compliant OCR scanning software, such as ABBYY FineReader. To download Epson Scan, visit Epson's driver download site ([U.S. downloads](#) or [Canadian downloads](#)).

Parent topic: [Solving Scanning Problems](#)

Related references

[Windows System Requirements](#)

[Mac System Requirements](#)

Cannot Start Epson Scan

If you cannot start Epson Scan, try these solutions:

- Make sure your product is turned on and any interface cables are securely connected at both ends.
- Make sure Epson Scan is selected in your scanning program.
- Make sure your computer is not running in a power-saving mode, such as sleep or standby. If so, wake your system and restart Epson Scan.
- Check the connection setting and test the connection using Epson Scan Settings:

Windows 8: Navigate to the **Start** screen and select **EPSON Scan Settings**. Make sure the correct **Connection** setting is selected, then click the **Test** button.

Windows (other versions): Click  or **Start > All Programs** or **Programs > EPSON > EPSON Scan > EPSON Scan Settings**. Make sure the correct **Connection** setting is selected, then click the **Test** button.

Mac OS X: Open the **Applications** folder, click **Epson Software**, and click **EPSON Scan Settings**. Make sure the correct **Connection** setting is selected, then click the **Test** button.

- Make sure you do not have multiple versions of Epson Scan installed. If you do, uninstall both versions and install one version.
- If you upgraded your operating system but did not reinstall Epson Scan, try reinstalling it.

Note: With Mac OS X 10.6, 10.7, or 10.8, in addition to scanning with Image Capture, you can download and install Epson Scan scanning software. Epson Scan provides additional image adjustment and photo correction features for enhancing scanned images, and provides an interface for TWAIN-compliant OCR scanning software, such as ABBYY FineReader. To download Epson Scan, visit Epson's driver download site ([U.S. downloads](#) or [Canadian downloads](#)).

Parent topic: [Solving Scanning Problems](#)

Related tasks

[Scanning with Mac OS X 10.6/10.7/10.8 Using Image Capture](#)

Related topics

[Starting a Scan](#)

Solving Scanned Image Quality Problems

Check these sections if a scanned image on your computer screen has a quality problem.

[Image Consists of a Few Dots Only](#)

[Line of Dots Appears in All Scanned Images](#)

[Straight Lines in an Image Appear Crooked](#)

[Image is Distorted or Blurry](#)

[Image Colors are Patchy at the Edges](#)

[Image is Too Dark](#)

[Back of Original Image Appears in Scanned Image](#)

[Ripple Patterns Appear in an Image](#)

[Image is Scanned Upside-Down](#)

[Scanned Image Colors Do Not Match Original Colors](#)
[Scan Area is Not Adjustable in Thumbnail Preview](#)
[Scanned Image Edges are Cropped](#)

Parent topic: [Solving Problems](#)

Related topics

[Solving Print Quality Problems](#)

Image Consists of a Few Dots Only

If your scanned image consists only of a few dots, try these solutions:

- Make sure you placed your original for scanning facing the correct way.
- If you are scanning using the Epson Scan **Black & White** setting, adjust the **Threshold** setting and scan again.

Parent topic: [Solving Scanned Image Quality Problems](#)

Related references

[Available Image Adjustments - Home Mode](#)

[Available Image Adjustments - Office Mode](#)

[Available Image Adjustments - Professional Mode](#)

Related tasks

[Placing Originals on the Scanner Glass](#)

Line of Dots Appears in All Scanned Images

If a line of dots appears in all your scanned images, clean the scanner glass with a soft, dry, lint-free cloth or use a small amount of glass cleaner on the cloth, if necessary. Paper towels are not recommended.

Caution: Do not spray glass cleaner directly on the scanner glass.

Parent topic: [Solving Scanned Image Quality Problems](#)

Related tasks

[Cleaning Your Product](#)

Straight Lines in an Image Appear Crooked

If straight lines in an original appear crooked in a scanned image, make sure to place your original straight when you scan it.

Parent topic: [Solving Scanned Image Quality Problems](#)

Related topics

[Placing Originals on the Product](#)

Image is Distorted or Blurry

If a scanned image appears distorted or blurry, try these solutions:

- Make sure your original is not wrinkled or warped. This may prevent the original from laying flat on the scanner glass.
- Do not move your original or your product during scanning.
- Your product will not operate properly while tilted at an angle. Place it on a flat, stable surface that extends beyond the base of the product in all directions.
- Adjust these Epson Scan settings (if available) and try scanning again:
 - Select the **Unsharp Mask** setting.
 - Adjust the **Auto Exposure** setting.
 - Increase the **Resolution** setting.

Parent topic: [Solving Scanned Image Quality Problems](#)

Related topics

[Selecting Epson Scan Settings](#)

Image Colors are Patchy at the Edges

If you are scanning a thick or warped original, cover its edges with paper to block external light as you scan it.

Parent topic: [Solving Scanned Image Quality Problems](#)

Image is Too Dark

If your scanned image is too dark, try these solutions:

- Adjust these Epson Scan settings (if available) and try scanning again:
 - **Auto Exposure**

- **Brightness**
- **Histogram Adjustment**
- Check the brightness and contrast settings of your computer monitor.

Parent topic: [Solving Scanned Image Quality Problems](#)

Related topics

[Selecting Epson Scan Settings](#)

Back of Original Image Appears in Scanned Image

If an image from the back of a thin original appears in your scanned image, place a piece of black paper on the back of the original and scan it again.

Parent topic: [Solving Scanned Image Quality Problems](#)

Ripple Patterns Appear in an Image

You may see a ripple pattern (called a moiré) in scanned images of printed documents. This is caused by interference from differing pitches in the scanner's screen and your original's halftone screen. To reduce this effect, adjust these Epson Scan settings (if available) and try scanning again:

- Select the **Descreening** setting.
- Select a lower **Resolution** setting.

Parent topic: [Solving Scanned Image Quality Problems](#)

Related topics

[Selecting Epson Scan Settings](#)

Image is Scanned Upside-Down

Your product scans using the **Auto Photo Orientation** setting. This setting checks the preview image for faces, the sky, and other features, and then correctly rotates the photo when it is scanned, if necessary. If your photo is not oriented correctly using this option, deselect the **Auto Photo Orientation** setting and scan again.

Parent topic: [Solving Scanned Image Quality Problems](#)

Scanned Image Colors Do Not Match Original Colors

Printed colors can never exactly match the colors on your computer monitor because printers and monitors use different color systems: monitors use RGB (red, green, and blue) and printers typically use CMYK (cyan, magenta, yellow, and black).

Check the color matching and color management capabilities of your computer, display adapter, and the software you are using to see if they are affecting the palette of colors you see on your screen.

To adjust the colors in your scanned image, adjust these Epson Scan settings (if available) and try scanning again:

- Change the **Image Type** setting and experiment with different combinations of the next settings.
- Adjust the **Tone Correction** setting.
- Adjust the **Auto Exposure** setting.

Parent topic: [Solving Scanned Image Quality Problems](#)

Related topics

[Selecting Epson Scan Settings](#)

Scan Area is Not Adjustable in Thumbnail Preview

If you cannot adjust the scan area while viewing a Thumbnail preview in Epson Scan, try these solutions:

- Create a scan area by drawing a marquee on your preview image and adjusting it as necessary.
- Switch to Normal preview mode, if available, and preview your image again.

Parent topic: [Solving Scanned Image Quality Problems](#)

Related concepts

[Image Preview Guidelines](#)

Related tasks

[Selecting a Scan Area - Home Mode](#)

[Selecting a Scan Area - Professional Mode](#)

Scanned Image Edges are Cropped

If the edges of a scanned image are cropped, make sure your original is placed correctly for scanning. If necessary, move your original away from the edges of the scanner glass slightly.

Parent topic: [Solving Scanned Image Quality Problems](#)

Related tasks

[Placing Originals on the Scanner Glass](#)

Solving Faxing Problems

Check these solutions if you have problems faxing with your product.

[Cannot Send or Receive Faxes](#)

[Cannot Receive Faxes with a Telephone Connected to Your Product](#)

Parent topic: [Solving Problems](#)

Cannot Send or Receive Faxes

If you cannot send or receive faxes, try these solutions:

- Make sure the recipient's fax machine is turned on and working.
- Make sure paper is loaded correctly in your product.
- Make sure Auto Answer mode is turned on to receive faxes automatically. Check your product control panel to see if this mode is turned on.
- Check that the cable connecting your telephone wall jack to your product's **LINE** port is secure.
- Print a fax connection report using your product control panel or fax software to help diagnose the problem.
- Verify that the telephone wall jack works by connecting a phone to it and testing it.
- If there is no dial tone and you connected the product to a PBX (Private Branch Exchange) phone line or Terminal Adapter, turn off your product's dial tone detection settings.
- If you connected your product to a DSL phone line, you must connect a DSL filter to the phone jack to enable faxing over the line. Contact your DSL provider for the necessary filter.
- If your telephone line has static, turn off your product's error correction mode fax communication setting and try faxing again.
- Try lowering your product's fax speed setting.
- Make sure the error correction mode setting is turned on if you are trying to send or receive a color fax.

Note: Do not turn the product off while it is receiving a fax. Otherwise, the fax transmission will be lost.

Note: If your product is connected to a VoIP (Voice over Internet Protocol) phone line, keep in mind that fax machines are designed to work over analog phone lines. Epson cannot guarantee that fax transmission will work when using VoIP.

If your phone line includes voice mail answering services, calls or faxes may be inadvertently received by your voice mail service.

Parent topic: [Solving Faxing Problems](#)

Related tasks

[Receiving Faxes Automatically \(Auto Answer\)](#)
[Connecting a Telephone or Answering Machine](#)
[Printing Fax Reports](#)
[Selecting Fax Communication Settings](#)

Related topics

[Loading Paper](#)
[Placing Originals on the Product](#)

Cannot Receive Faxes with a Telephone Connected to Your Product

Make sure your telephone is connected to your product's **EXT** port.

Note: When answering a call that is a fax, wait until the product's LCD screen displays a message that a connection has been made before you hang up.

Parent topic: [Solving Faxing Problems](#)

Related tasks

[Connecting a Telephone or Answering Machine](#)

Cannot Transfer Files To or From a USB Flash Drive

If you have problems transferring files to or from a USB flash drive inserted in your product, try these solutions:

- Make sure your flash drive is compatible with the product.
- Make sure your product is securely connected to your computer.
- Make sure that the file sharing setting for your product is set correctly.

Parent topic: [Solving Problems](#)

Related references

[External USB Device Specifications](#)

Related tasks

[Setting Up File Sharing for File Transfers From Your Computer](#)

When to Uninstall Your Product Software

If you have a problem that requires you to uninstall and re-install your software, follow the instructions for your operating system.

[Uninstalling Product Software - Windows](#)

[Uninstalling Product Software - Mac OS X](#)

Parent topic: [Solving Problems](#)

Uninstalling Product Software - Windows

You can uninstall and then re-install your product software to solve certain problems.

1. Turn off the product.
2. Disconnect any interface cables.
3. Do one of the following:
 - **Windows 8:** Navigate to the **Start** screen, right-click the screen, and select **All apps**. Select **Control Panel > Programs > Programs and Features**. Select **EPSON Software Uninstall**, then select **Uninstall/Change**.

Note: If you see a **User Account Control** window, click **Yes** or **Continue**.

Select your product again, if necessary, then select **OK**, and click **Yes** to confirm the uninstallation.

- **Windows (other versions):** Click  or **Start**, and select **All Programs** or **Programs**. Select **EPSON**, select your product, then click **EPSON Printer Software Uninstall**.

Note: If you see a **User Account Control** window, click **Yes** or **Continue**.

In the next window, select your product and click **OK**. Then follow any on-screen instructions.

4. Do one of the following to uninstall Epson Event Manager, then follow any on-screen instructions:
 - **Windows 8:** Select **Epson Event Manager** and click **Uninstall**.
 - **Windows 7 or Windows Vista:** Open the Windows **Control Panel** utility. Select **Programs and Features**. (In Classic view, select **Programs** and click **Uninstall a program**.) Select **Epson Event Manager** and click **Uninstall/Change**.
 - **Windows XP:** Open the Windows **Control Panel** utility. Double-click **Add or Remove Programs**. Select **Epson Event Manager** and click **Change/Remove**.

5. Do one of the following to uninstall Epson Scan, then follow any on-screen instructions:
 - **Windows 8:** Select **EPSON Scan** and click **Uninstall/Change**.
 - **Windows 7 or Windows Vista:** Select **EPSON Scan** and click **Uninstall/Change**.
 - **Windows XP:** Select **EPSON Scan** and click **Change/Remove**.
6. Restart your computer, then see the *Start Here* sheet to re-install your software.

Note: If you find that re-installing your product software does not solve a problem, contact Epson.

Parent topic: [When to Uninstall Your Product Software](#)

Uninstalling Product Software - Mac OS X

In most cases, you do not need to uninstall your product software before re-installing it. However, you can download the Uninstaller utility from the Epson support website to uninstall your product software as described here.

Note: If you find that re-installing your product software does not solve a problem, contact Epson.

1. To download the Uninstaller utility, visit the Epson download site ([U.S. downloads](#) or [Canadian downloads](#)).
2. Follow the instructions on the screen to install the Uninstaller utility.
3. Quit all applications currently running on your Mac.
4. Double-click the **Uninstaller** icon.
5. Select the checkbox for each software program you want to uninstall.
6. Click **Uninstall**.
7. Follow the on-screen instructions to uninstall the software.
8. To reinstall your product software, see the *Start Here* sheet for instructions.

Note: If you uninstall the printer driver and your product name remains in the Print & Fax or Print & Scan window, select your product name and click the – (remove) icon to remove it.

Parent topic: [When to Uninstall Your Product Software](#)

Where to Get Help

If you need to contact Epson for technical support services, use the following support options.

Internet Support

Visit Epson's support website at www.epson.com/support (U.S.) or www.epson.ca/support (Canada) for solutions to common problems. You can download drivers and documentation, get FAQs and troubleshooting advice, or e-mail Epson with your questions.

Speak to a Support Representative

Before you call Epson for support, please have the following information ready:

- Product name
- Product serial number (located on a label on the product)
- Proof of purchase (such as a store receipt) and date of purchase
- Computer configuration
- Description of the problem

Then call:

- U.S.: (562) 276-4382, 6 AM to 8 PM, Pacific Time, Monday through Friday, and 7 AM to 4 PM, Pacific Time, Saturday
- Canada: (905) 709-3839, 6 AM to 8 PM, Pacific Time, Monday through Friday, and 7 AM to 4 PM, Pacific Time, Saturday

Days and hours of support are subject to change without notice. Toll or long distance charges may apply.

Purchase Supplies and Accessories

You can purchase genuine Epson ink and paper at Epson Supplies Central at www.epson.com/ink3 (U.S. sales) or www.epson.ca (Canadian sales). You can also purchase supplies from an Epson authorized reseller. To find the nearest one, call 800-GO-EPSON (800-463-7766).

Parent topic: [Solving Problems](#)

Technical Specifications

These sections list the technical specifications for your product.

Note: Epson offers a recycling program for end of life products. Please go to www.epson.com/recycle for information on how to return your products for proper disposal.

[Windows System Requirements](#)

[Mac System Requirements](#)

[Printing Specifications](#)

[Scanning Specifications](#)

[Automatic Document Feeder \(ADF\) Specifications](#)

[Fax Specifications](#)

[Paper Specifications](#)

[Printable Area Specifications](#)

[Ink Cartridge Specifications](#)

[Dimension Specifications](#)

[Electrical Specifications](#)

[Environmental Specifications](#)

[Interface Specifications](#)

[External USB Device Specifications](#)

[Network Interface Specifications](#)

[Safety and Approvals Specifications](#)

Windows System Requirements

To use your product and its software, your computer should use one of these Microsoft operating systems:

- Windows 8
- Windows 7
- Windows Vista
- Windows XP Professional x64 Edition
- Windows XP SP3

Note: Visit Epson's support website at www.epson.com/support (U.S.) or www.epson.ca/support (Canada) for the latest in compatibility and drivers for your product.

Parent topic: [Technical Specifications](#)

Mac System Requirements

To use your product and its software, your Mac should use one of these operating systems:

- Mac OS X 10.5.8
- Mac OS X 10.6.x
- Mac OS X 10.7.x
- Mac OS X 10.8.x

Note: Visit Epson's support website at www.epson.com/support (U.S.) or www.epson.ca/support (Canada) for the latest in compatibility and drivers for your product.

Parent topic: [Technical Specifications](#)

Printing Specifications

Paper path	Rear paper feed, top entry
Sheet feeder capacity	Approximately 100 sheets at 20 lb (75 g/m ²)

Parent topic: [Technical Specifications](#)

Related references
[Paper Loading Capacity](#)

Scanning Specifications

Scanner type	Flatbed, color
Photoelectric device	CIS
Effective pixels	10,200 × 14,040 pixels at 1200 dpi
	Scanning area may be restricted if resolution setting is large.

Document size	Maximum: 8.5 × 11.7 inches (216 × 297 mm) Scanner glass: US letter or A4
Scanning resolution	1200 dpi (main scan) 2400 dpi (sub scan)
Output resolution	50 to 4800, 7200, and 9600 dpi (50 to 4800 dpi in 1 dpi increments)
Image data	16 bits per pixel per color internal 8 bits per pixel per color external (maximum)
Light source	LED

Parent topic: [Technical Specifications](#)

Automatic Document Feeder (ADF) Specifications

Paper input	Faceup loading
Paper output	Facedown ejection
Paper size	US letter, legal, or A4 size
Paper type	Plain paper
Paper weight	17 lb (64 g/m ²) to 24 lb (95 g/m ²)
Sheet feeding capacity	Total thickness: 0.12 inch (3 mm) Approximately 30 sheets (US letter or A4) or 10 sheets (legal)

Parent topic: [Technical Specifications](#)

Fax Specifications

Fax type	Black-and-white and color fax capability
Support line	Household phone line
Speed	Up to 33.6 kbps

Resolution	<p>Monochrome</p> <p>Standard: 203 × 98 dpi</p> <p>Fine: 203 × 196 dpi</p> <p>Photo: 203 × 196 dpi</p> <p>Color</p> <p>Fine: 200 × 200 dpi</p> <p>Photo: 200 × 200 dpi</p>
Error correction mode	CCITU/ITU Group 3 fax with error correction mode
Speed dial/group dial numbers	Up to 60 (combined)
Page memory	Up to 180 (ITU-T No. 1 chart)
Redial	2 times (with 1 minute interval)
Interface	RJ-11 Phone Line RJ-11 Telephone set connection

Parent topic: [Technical Specifications](#)

Paper Specifications

Note: Since the quality of any particular brand or type of paper may be changed by the manufacturer at any time, Epson cannot guarantee the quality of any non-EPSON brand or type of paper. Always test a sample of paper stock before purchasing large quantities or printing large jobs.

Single-sheets

Size	A4 (8.3 × 11.7 inches [210 × 297 mm]) 4 × 6 inches (102 × 152 mm) 5 × 7 inches (127 × 178 mm) A6 (4.1 × 5.8 inches [105 × 148 mm]) A5 (5.8 × 8.2 inches [148 × 210 mm]) B5 (182 × 257 mm) 3.5 × 5 inches (89 × 127 mm) 5 × 8 inches (127 × 203 mm) 8 × 10 inches (203 × 254 mm) 16:9 wide (4 × 7.1 inches [102 × 181 mm]) 3.9 × 5.8 inches (100 × 148 mm) Letter (8.5 × 11 inches [216 × 279 mm]) Legal (8.5 × 14 inches [216 × 357 mm])
Paper types	Plain paper and paper distributed by Epson
Thickness	0.003 (0.08 mm) to 0.004 inch (0.11 mm)
Weight	17 lb (64 g/m ²) to 24 lb (90 g/m ²)

Envelopes

Size	No. 10 (4.1 × 9.5 inches [105 × 241 mm])
Paper types	Plain paper
Weight	20 lb (75 g/m ²) to 24 lb (90 g/m ²)

Parent topic: [Technical Specifications](#)

Printable Area Specifications

Note: When printing borderless, quality may decline in the expanded printable area.

Single sheets

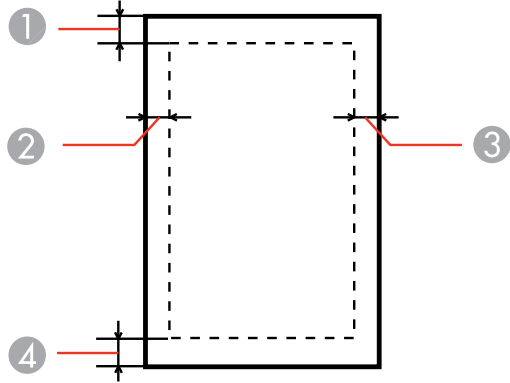

- 1 Top: 0.12 inch (3 mm) minimum
- 2 Left: 0.12 inch (3 mm) minimum
- 3 Right: 0.12 inch (3 mm) minimum
- 4 Bottom: 0.12 inch (3 mm) minimum

Envelopes

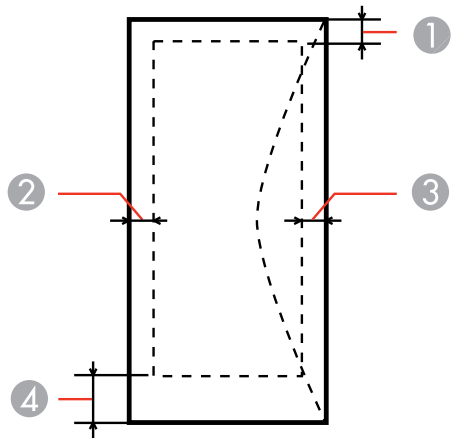

- 1 Left: 0.12 inch (3 mm) minimum
- 2 Bottom: 0.20 inch (5 mm) minimum
- 3 Top: 0.20 inch (5 mm) minimum
- 4 Right: 0.83 inch (21 mm) minimum

Parent topic: [Technical Specifications](#)

Ink Cartridge Specifications

Note: We recommend that you use genuine Epson cartridges and do not refill them. The use of other products may affect your print quality and could result in printer damage.

The cartridges included with the printer are designed for printer set up and not for resale. After some ink is used for priming, the rest is available for printing. Yields vary considerably based on images printed, print settings, paper type, frequency of use, and temperature. For print quality, a variable amount of ink remains in the cartridge after the "replace cartridge" indicator comes on.

Color	Cyan, Magenta, Yellow, Black
Cartridge life	Opened package: 6 months Unopened package: do not use if the date on the package has expired
Temperature	Storage: -4 to 104 °F (-20 to 40 °C) 1 month at 104 °F (40 °C) Ink freezes at 10.4 °F (-12 °C) Ink thaws and is usable after 3 hours at 77 °F (25 °C)

Note: For best printing results, use up a cartridge within 6 months of opening the package.

Parent topic: [Technical Specifications](#)

Related references

[Ink Cartridge Part Numbers](#)

Dimension Specifications

Height	Stored: 8.7 inches (221 mm) Printing: 11.5 inches (291 mm)
Width	Stored: 15.4 inches (392 mm) Printing: 15.4 inches (392 mm)
Depth	Stored: 14.8 inches (377 mm) Printing: 21.3 inches (540 mm)
Weight (without ink cartridges)	13.0 lb (5.9 kg)

Parent topic: [Technical Specifications](#)

Electrical Specifications

Power supply rating	100 to 240 V
Input voltage range	90 to 264 V
Rated frequency range	50/60 Hz
Input frequency range	49.5/60.5 Hz
Rated current	0.5/0.3 A
Power consumption	Standalone copying mode: 10 W (ISO/IEC24712) Ready mode: 5 W Sleep mode: 2.4 W Power off mode: 0.3 W

Parent topic: [Technical Specifications](#)

Environmental Specifications

Temperature	Operating: 50 to 95 °F (10 to 35 °C) Storage: –4 to 104 °F (–20 to 40 °C) 1 month at 104 °F (40 °C)
Humidity (non-condensing)	Operating: 20 to 80% RH Storage: 5 to 85% RH

Parent topic: [Technical Specifications](#)

Interface Specifications

Interface type	Hi-Speed USB (Device Class for computers) Hi-Speed USB (for Mass storage class for external storage)
-----------------------	---

Parent topic: [Technical Specifications](#)

External USB Device Specifications

USB flash drives	Up to 2TB Formatted in FAT, FAT32, or exFAT
-------------------------	--

Note: Epson cannot guarantee the compatibility of your external USB device.

Parent topic: [Technical Specifications](#)

Network Interface Specifications

Wireless LAN standard	IEEE 802.11 b/g/n
Wireless security	WPA-PSK (TKIP/AES); WPA2 compliant with support for WPA/WPA2 Personal WEP (64/128 bit)
Frequency band	2.4 GHz

Wireless Communication mode	Infrastructure mode Ad hoc mode
Ethernet standard	IEEE802.3i/u IEEE802.3az (the connected device should comply with IEEE802.3az)
Ethernet Communication mode	100BASE-TX/10BASE-T

Note: Wireless LAN standard complies with either IEEE 802.11 b/g or IEEE 802.11 b/g/n, depending on purchase location.

Parent topic: [Technical Specifications](#)

Safety and Approvals Specifications

United States	Safety: UL60950-1 EMC: FCC part 15 Subpart B Class B
Canada	Safety: CAN/CSA-C22.2 No. 60950-1 EMC: CAN/CSA-CEI/IEC CISPR 22 Class B

This equipment contains the following wireless module:

- Manufacturer: Askey Computer Corporation
- Type: WLU6117-D69 (RoHS)

This product conforms to Part 15 of the FCC Rules and RSS-210 of the IC Rules. Epson cannot accept responsibility for any failure to satisfy the protection requirements resulting from a non-recommended modification of the product. Operation is subject to the following two conditions: (1) this device may not cause harmful interference, and (2) this device must accept any interference received, including interference that may cause undesired operation of the device.

To prevent radio interference to the licensed service, this device is intended to be operated indoors and away from windows to provide maximum shielding. Equipment (or its transmit antenna) that is installed outdoors is subject to licensing.

Parent topic: [Technical Specifications](#)

Notices

Check these sections for important notices about your product.

Note: Epson offers a recycling program for end of life products. Please go to www.epson.com/recycle for information on how to return your products for proper disposal.

[FCC Compliance Statement](#)

[Software Notices](#)

[Trademarks](#)

[Copyright Notice](#)

FCC Compliance Statement

For United States Users

This equipment complies with Part 68 of the FCC rules and the requirements adopted by the Administrative Council for Terminal Attachments ("ACTA") . On the surface of this equipment is a label that contains, among other information, a product identifier in the format US:AAAEQ##TXXXX. If requested, this number must be provided to the telephone company.

Applicable certification jack Universal Service Order Codes ("USOC") for the equipment: RJ11C.

A plug and jack used to connect this equipment to the premises wiring and telephone network must comply with the applicable FCC Part 68 rules and requirements adopted by the ACTA. A compliant telephone cord and modular plug is provided with this product. It is designed to be connected to a compatible modular jack that is also compliant. See installation instructions for details.

The REN is used to determine the number of devices that may be connected to a telephone line. Excessive RENs on a telephone line may result in the devices not ringing in response to an incoming call. In most but not all areas, the sum of RENs should not exceed five (5.0). To be certain of the number of devices that may be connected to a line, as determined by the total RENs, contact the local telephone company. For products approved after July 23, 2001 , the REN for this product is part of the product identifier that has the format US:AAAEQ##TXXXX. The digits represented by ## are the REN without a decimal point (e.g., 03 is a REN of 0.3). For earlier products, the REN is separately shown on the label.

If this equipment causes harm to the telephone network, the telephone company will notify you in advance that temporary discontinuance of service may be required. But if advance notice isn't practical, the telephone company will notify the customer as soon as possible. Also, you will be advised of your right to file a complaint with the FCC if you believe it is necessary.

The telephone company may make changes in its facilities, equipment, operations or procedures that could affect the operation of the equipment. If this happens the telephone company will provide advance notice in order for you to make necessary modifications to maintain uninterrupted service.

If you have problems with this product and require technical or customer support, please visit www.epson.com for more information.

This product is not intended to be repaired by the customer. If you experience trouble connecting this equipment to a telephone line, please contact:

Name: Epson America, Inc.

Address: 3840 Kilroy Airport Way, Long Beach, CA 90806 U.S.A.

Telephone: (562) 981-3840

If the equipment is causing harm to the telephone network, the telephone company may request that you disconnect the equipment until the problem is resolved.

This equipment may not be used on coin service provided by the telephone company. Connection to party line service is subject to state tariffs. Contact the state public utility commission, public service commission or corporation commission for information.

If your home has specially wired alarm equipment connected to the telephone line, ensure the installation of this equipment does not disable your alarm equipment. If you have questions about what will disable alarm equipment, consult your telephone company or a qualified installer.

The Telephone Consumer Protection Act of 1991 makes it unlawful for any person to use a computer or other electronic device, including fax machines, to send any message unless such message clearly contains in a margin at the top or bottom of each transmitted page or on the first page of the transmission, the date and time it is sent and an identification of the business or other entity, or other individual sending the message and the telephone number of the sending machine or such business, other entity, or individual. (The telephone number provided may not be a 900 number or any other number for which charges exceed local or long-distance transmission charges.)

In order to program this information into your fax machine, follow the instructions in "Entering Fax Header Information".

According to the FCC's electrical safety advisory, we recommend that you may install an AC surge arrester in the AC outlet to which this equipment is connected. Telephone companies report that electrical surges, typically lightning transients, are very destructive to customer terminal equipment connected to AC power sources and that this is a major nationwide problem.

This equipment has been tested and found to comply with the limits for a Class B digital device, pursuant to Part 15 of the FCC Rules. These limits are designed to provide reasonable protection against harmful interference in a residential installation. This equipment generates, uses, and can radiate radio frequency energy and, if not installed and used in accordance with the instructions, may cause harmful

interference to radio or television reception. However, there is no guarantee that interference will not occur in a particular installation. If this equipment does cause interference to radio and television reception, which can be determined by turning the equipment off and on, the user is encouraged to try to correct the interference by one or more of the following measures:

- Reorient or relocate the receiving antenna.
- Increase the separation between the equipment and receiver.
- Connect the equipment into an outlet on a circuit different from that to which the receiver is connected.
- Consult the dealer or an experienced radio/TV technician for help.

WARNING

The connection of a non-shielded equipment interface cable to this equipment will invalidate the FCC Certification or Declaration of this device and may cause interference levels which exceed the limits established by the FCC for this equipment. It is the responsibility of the user to obtain and use a shielded equipment interface cable with this device. If this equipment has more than one interface connector, do not leave cables connected to unused interfaces. Changes or modifications not expressly approved by the manufacturer could void the user's authority to operate the equipment.

For Canadian Users

1. This product meets the applicable Industry Canada technical specifications.
2. The Ringer Equivalence Number is an indication of the maximum number of devices allowed to be connected to a telephone interface. The termination on an interface may consist of any combination of devices subject only to the requirement that the sum of the RENs of all the devices does not exceed five.

This Class B digital apparatus complies with Canadian ICES-003.

Le présent matériel est conforme aux spécifications techniques applicables d'Industrie Canada.

L'indice d'équivalence de la sonnerie (IES) sert à indiquer le nombre maximal de terminaux qui peuvent être raccordés à une interface téléphonique. La terminaison d'une interface peut consister en une combinaison quelconque de dispositifs, à la seule condition que la somme d'indices d'équivalence de la sonnerie de tous les dispositifs n'excède pas 5.

Cet appareil numérique de la classe B est conforme à la norme NMB-003 du Canada.

Parent topic: [Notices](#)

Software Notices

OPEN SOURCE SOFTWARE LICENSE

1. This printer product includes open source software programs listed in Section 6) according to the license terms of each open source software program.
2. We provide the source code of the GPL Programs, LGPL Programs and Apache License Program (each is defined in Section 6) until five (5) years after the discontinuation of same model of this printer product. If you desire to receive the source code above, please contact the customer support of your region. You shall comply with the license terms of each open source software program.
3. The open source software programs are WITHOUT ANY WARRANTY; without even the implied warranty of MERCHANTABILITY AND FITNESS FOR A PARTICULAR PURPOSE. See the license agreements of each open source software program for more details, which are described in OSS.pdf on your Printer Software CD.
4. OpenSSL toolkit
This printer product includes software developed by the OpenSSL project for use in the OpenSSL Toolkit (<http://www.openssl.org/>).
This product includes cryptographic software written by Eric Young (eay@cryptsoft.com).
5. The license terms of each open source software program are described in OSS.pdf on your Printer Software CD.
6. The list of open source software programs which this printer product includes are as follows.

GNU GPL

This printer product includes the open source software programs which apply the GNU General Public License Version 2 or later version ("GPL Programs").

The list of GPL Programs:

base-passwd-3.5.7

busybox-1.2.2.1

ifupdown-0.6.8

kernel-2.6.18

lsp-arm-versatile926ejs-2.6.18_pro500

module-init-tools-3.2pre1

mount-2.12

net-tools-1.60

netbase-4.29
psmisc-21.5
readline-libs-5.0
sysvinit-2.86
udev-0.093
udhcp 0.9.8cvs20050124-5
util-linux-2.12
usb8786

GNU LGPL

This printer product includes the open source software programs which apply the GNU Lesser General Public License Version 2 or later version ("LGPL Programs").

The list of LGPL Programs:

uclibc-0.9.29
libusb-libs-0.1.12
zeroconf 0.6.1-1
iksemel 1.4

Apache License

This printer product includes the open source software program "Bonjour" which apply the Apache License Version2.0 ("Apache License Program").

Bonjour License

This printer product includes the open source software program "Bonjour " which applies the terms and conditions provided by owner of the copyright to the "Bonjour ".

Net-SNMP license

This printer product includes the open source software program "Net-SNMP" which applies the terms and conditions provided by owner of the copyright to the "Net-SNMP".

OpenSSL License/Original SSLeay License

This printer product includes the open source software program "OpenSSL toolkit" which applies the license terms of OpenSSL License and Original SSLeay License.

BSD License (Berkeley Software Distribution License)

This printer product includes the open source software programs which apply the Berkeley Software Distribution License ("BSD Programs").

The list of BSD Programs:

busybox-1.2.2.1

util-linux-2.12

mount-2.12

mvutils-2.8.4

netkit-ftp-0.17

netkit-base-0.17

portmap-5beta

Sun RPC License

This printer product includes the open source software programs which apply the Sun RPC License ("Sun RPC Programs").

The list of Sun RPC Programs:

busybox- 1.2.2.1

netkit-inetd-0.17

portmap-5beta

TCP Wrappers license

This printer product includes the open source software program "libwrap-libs-7.6 " which applies the terms and conditions provided by owner of the copyright to the "TCP Wrappers".

libncurses license

This printer product includes the open source software program "libncurses-5.4 " which applies the terms and conditions provided by owner of the copyright to the "libncurses".

busybox license

This printer product includes the open source software program "busybox- 1.2.2.1 " which applies the terms and conditions provided by owner of the copyright to the "busybox".

linux-ftpd license

This printer product includes the open source software program "linux-ftpd-0.17 " which applies the terms and conditions provided by owner of the copyright to the "linux-ftpd".

ARC4 license

This printer product includes the open source software program "ARC4" which applies the terms and conditions provided by owner of the copyright to the "ARC4".

json_parser license

This printer product includes the open source software program "json_parser" which applies the terms and conditions provided by owner of the copyright to the " json_parser ".

MD5 license

This printer product includes the open source software program "MD5" which applies the terms and conditions provided by owner of the copyright to the " MD5 ".

AES license

This printer product includes the open source software program "AES" which applies the terms and conditions provided by owner of the copyright to the "AES".

SHA1 license

This printer product includes the open source software program "SHA1" which applies the terms and conditions provided by owner of the copyright to the "SHA1".

Parent topic: [Notices](#)

Trademarks

EPSON® and Supplies Central® are registered trademarks, EPSON Connect™ is a trademark, and EPSON Exceed Your Vision is a registered logomark of Seiko Epson Corporation.

EPSON iPrint™ and Remote Print™ are trademarks of Seiko Epson Corporation.

Apple, iPad, iPhone, iPod touch, and Mac OS are trademarks of Apple Inc., registered in the U.S. and other countries. AirPrint is a trademark of Apple Inc.

General Notice: Other product names used herein are for identification purposes only and may be trademarks of their respective owners. Epson disclaims any and all rights in those marks.



Parent topic: [Notices](#)

Copyright Notice

All rights reserved. No part of this publication may be reproduced, stored in a retrieval system, or transmitted in any form or by any means, electronic, mechanical, photocopying, recording, or otherwise, without the prior written permission of Seiko Epson Corporation. The information contained herein is designed only for use with this Epson product. Epson is not responsible for any use of this information as applied to other products.

Neither Seiko Epson Corporation nor its affiliates shall be liable to the purchaser of this product or third parties for damages, losses, costs, or expenses incurred by purchaser or third parties as a result of: accident, misuse, or abuse of this product or unauthorized modifications, repairs, or alterations to this product, or (excluding the U.S.) failure to strictly comply with Seiko Epson Corporation's operating and maintenance instructions.

Seiko Epson Corporation shall not be liable for any damages or problems arising from the use of any options or any consumable products other than those designated as Original Epson Products or Epson Approved Products by Seiko Epson Corporation.

Seiko Epson Corporation shall not be held liable for any damage resulting from electromagnetic interference that occurs from the use of any interface cables other than those designated as Epson approved Products by Seiko Epson Corporation.

This information is subject to change without notice.

[libTIFF Software Acknowledgment](#)

[A Note Concerning Responsible Use of Copyrighted Materials](#)

[Default Delay Times for Power Management for Epson Products](#)

[Copyright Attribution](#)

Parent topic: [Notices](#)

libTIFF Software Acknowledgment

Copyright © 1988-1997 Sam Leffler

Copyright © 1991-1997 Silicon Graphics, Inc.

Permission to use, copy, modify, distribute, and sell this software and its documentation for any purpose is hereby granted without fee, provided that (i) the above copyright notices and this permission notice appear in all copies of the software and related documentation, and (ii) the names of Sam Leffler and Silicon Graphics may not be used in any advertising or publicity relating to the software without the specific, prior written permission of Sam Leffler and Silicon Graphics.

THE SOFTWARE IS PROVIDED "AS-IS" AND WITHOUT WARRANTY OF ANY KIND, EXPRESS, IMPLIED OR OTHERWISE, INCLUDING WITHOUT LIMITATION, ANY WARRANTY OF MERCHANTABILITY OR FITNESS FOR A PARTICULAR PURPOSE.

IN NO EVENT SHALL SAM LEFFLER OR SILICON GRAPHICS BE LIABLE FOR ANY SPECIAL, INCIDENTAL, INDIRECT OR CONSEQUENTIAL DAMAGES OF ANY KIND, OR ANY DAMAGES WHATSOEVER RESULTING FROM LOSS OF USE, DATA OR PROFITS, WHETHER OR NOT ADVISED OF THE POSSIBILITY OF DAMAGE, AND ON ANY THEORY OF LIABILITY, ARISING OUT OF OR IN CONNECTION WITH THE USE OR PERFORMANCE OF THIS SOFTWARE.

Parent topic: [Copyright Notice](#)

A Note Concerning Responsible Use of Copyrighted Materials

Epson encourages each user to be responsible and respectful of the copyright laws when using any Epson product. While some countries' laws permit limited copying or reuse of copyrighted material in certain circumstances, those circumstances may not be as broad as some people assume. Contact your legal advisor for any questions regarding copyright law.

Parent topic: [Copyright Notice](#)

Default Delay Times for Power Management for Epson Products

This product will enter sleep mode after a period of nonuse. This is to ensure that the product meets Energy Star standards of energy efficiency. More energy savings can be achieved by setting the time to sleep to a shorter interval.

Parent topic: [Copyright Notice](#)

Copyright Attribution

© 2013 Epson America, Inc.

2/13

CPD-37345R1

Parent topic: [Copyright Notice](#)