



Owner's Manual

DLP PROJECTOR

Please read this manual carefully before operating your projector and retain it for future reference.

PB63U

LICENSES

Supported licenses may differ by model. For more information about licenses, visit www.lg.com.



Manufactured under license from Dolby Laboratories. "Dolby" and the double-D symbol are trademarks of Dolby Laboratories.



ABOUT DIVX VIDEO: DivX® is a digital video format created by DivX, LLC, a subsidiary of Rovi Corporation. . This is an official DivX Certified® device that plays DivX video. Visit divx.com for more information and software tools to convert your files into DivX video.

ABOUT DIVX VIDEO-ON-DEMAND: This DivX Certified® device must be registered in order to play purchased DivX Video-on-Demand (VOD) movies. To obtain your registration code, locate the DivX VOD section in your device setup menu. Go to vod.divx.com for more information on how to complete your registration.

"DivX Certified® to play DivX® video up to HD 1080p, including premium content."

"DivX®, DivX Certified® and associated logos are trademarks of Rovi Corporation or its subsidiaries and are used under license."

"Covered by one or more of the following U.S. patents :
7,295,673; 7,460,668; 7,515,710; 7,519,274"



The terms HDMI and HDMI High-Definition Multimedia Interface, and the HDMI logo are trademarks or registered trademarks of HDMI Licensing LLC in the United States and other countries.

This device meets the EMC requirements for home appliances (Class B) and is intended for home usage. This device can be used in all regions.



NOTE

- Image shown may differ from your projector.
- Your projector's OSD (On Screen Display) may differ slightly from that shown in this manual.

SAFETY INSTRUCTIONS

Please take note of the safety instructions to prevent any potential accident or misuse of the projector.

- Safety precautions are given in two forms, i.e. Warning and Caution as detailed below.

 **WARNING:** Failure to follow the instructions may cause serious injury and even death.

 **CAUTION:** Failure to follow the instructions may cause injury to persons or damage to the product.

- Read the owner's manual carefully and keep it to hand.



WARNING/CAUTION

**RISK OF ELECTRIC SHOCK
DO NOT OPEN**



The lightning flash with arrowhead symbol, within an equilateral triangle, is intended to alert the user to the presence of uninsulated "dangerous voltage" within the product's enclosure that may be of sufficient magnitude to constitute a risk of electric shock to persons.

The exclamation point within an equilateral triangle is intended to alert the user to the presence of important operating and maintenance (servicing) instructions in the literature accompanying the appliance.

WARNING/CAUTION

– TO REDUCE THE RISK OF FIRE AND ELECTRIC SHOCK, DO NOT EXPOSE THIS PRODUCT TO RAIN OR MOISTURE.

Read these instructions.

Keep these instructions.

Heed all warnings.

Follow all instructions.

Indoor Installation

WARNING

- Do not place the projector in direct sunlight or near heat sources such as radiators, fires, stoves, etc.
 - This may cause a fire.
- Do not place flammable materials such as aerosols near the projector.
 - This may cause a fire.
- Do not allow your children to cling to or climb up to the projector.
 - The projector may fall down and cause personal injury or death.
- Do not place the projector directly on a carpet, rug or place where ventilation is restricted such as a book shelf or closet.
 - This may cause the projector's internal temperature to rise and cause a fire.
- Do not place the projector close to sources of steam or oil such as a humidifier or kitchen counter.
 - This may cause a fire hazard or an electric shock.

WARNING: This product contains chemicals known to the State of California to cause cancer and birth defects or other reproductive harm.

Wash hands after handling.

- Do not place the projector where it might be exposed to excessive dust.
 - This may cause a fire.
- Do not use the projector in a damp place such as a bathroom where it is likely to get wet.
 - This may cause a fire or an electric shock.
- Do not allow a tablecloth or curtain to block the vents.
 - This may cause the internal temperature of the projector to rise and cause a fire.
- The distance between the projector and the wall should be more than 30 cm for ventilation purposes.
 - Otherwise, this may cause the internal temperature of the projector to rise and cause a fire.

 **CAUTION**

- When installing the projector on a table, be careful not to place it near the edge.
 - The projector may fall causing injury to persons or damage to the projector. Make sure that you use a stand suitable for the size of projector.
- Turn off the projector, disconnect the power supply and remove all connections before moving the projector.
 - A damaged cord may cause a fire or an electric shock.
- Do not install the projector on an unstable or vibrating surface such as a vibrating shelf or tilted surface.
 - It may fall and cause injury.
- Be careful not to tip the projector over when connecting external devices to the projector.
 - This may cause injury to persons or damage to the projector.

Power

 **WARNING**

- The earth wire should be connected.
 - Inappropriate earth grounding may cause damage to the projector or an electric shock when there is an electrical surge.
If the projector must be installed at a place where earth grounding is not possible, purchase a circuit breaker and connect the projector to its wall outlet.
Do not ground the projector to the gas pipe, water pipe, lightning rod, or telephone line, etc.
- The power plug should be fully inserted into the wall outlet.
 - Unstable connection may cause a fire.
- Do not place heavy objects on the power cord or place the cord underneath the projector.
 - This may cause a fire or an electric shock.
- Never touch the power plug with a wet hand.
 - This may cause an electric shock.
- Do not connect too many devices to the same power extension.
 - Overheating may cause a fire.
- Remove dust or contaminants around power plug pins or wall outlets.
 - This may cause a fire.
- To turn off the main power, remove the power plug, which should be positioned so it is easy to access for operation.

⚠ CAUTION

- Hold the plug firmly when unplugging.
 - A broken wire in the cord may cause a fire.
- Ensure the power cord or plug is not damaged, modified, severely bent, twisted, pulled, sandwiched or heated. Do not use a loose wall outlet.
 - This may cause a fire or an electric shock.
- Keep the power cord away from any heating devices.
 - The cord coating may melt and cause an electric shock.
- Place the projector where people will not trip over or tread on the power cord or plug to protect the power cord and plug from any damage.
 - This may cause a fire hazard or an electric shock.
- Do not turn the projector on or off by plugging in the power plug or unplugging it from the wall outlet. (Do not use the power plug as a switch.)
 - This may cause an electric shock or damage to the projector.
- Do not insert a conductor into the other side of the wall outlet while the power plug is inserted into the wall outlet.

In addition, do not touch the power plug immediately after it is disconnected from the wall outlet.

 - This may cause an electric shock.
- Use only the official power cord which is provided by LG Electronics, Inc. Do not use other power cords.
 - This may cause a fire or an electric shock.

When in Use**⚠ WARNING**

- Do not place anything containing liquid, such as a vase, flowerpot, cup, cosmetics, chemicals, decorations or candles, etc., on top of the projector.
 - Possible fire, electric shock, or falling may cause physical injury.
- In the event that there is a big impact to the projector or the cabinet is damaged, switch it off, unplug it from the wall outlet and contact an authorized service center.
 - Otherwise, this may cause a fire or an electric shock.
- Do not insert pieces of metal such as coins, hairpins or metal debris, nor flammable materials such as paper or matches into the projector.
 - This may cause a fire or an electric shock.
- In the event that liquid or a foreign object falls into the projector, please switch it off and unplug it from the wall outlet and contact an LG Electronics Service Center.
 - Otherwise, this may cause a fire or an electric shock.
- When replacing a battery of the remote control, make sure a child does not swallow the battery. Keep the battery out of reach of children.
 - In the case of a battery being swallowed by a child, please consult a doctor immediately.
- Do not remove any covers except for the lens cap. There is a high risk of electric shock.

- Do not look directly into the lens when the projector is in use. The strong light may damage your eyes.
- When the lamp is on or has just been turned off, avoid touching the air vent or lamp because these will be very hot.
- If there is a gas leak, do not touch the wall outlet. Open the window for ventilation.
 - A spark may cause a fire or burn.
- Never touch the projector or power cord during thunder or lightning.
 - This may cause an electric shock.
- Do not use the projector near an electronic device which generates a strong magnetic field.
- Store the vinyl envelope used to pack the projector in a safe place away from children.
 - It could cause suffocation if used improperly.
- Do not use 3D glasses if you do not watch 3D.
- Do not keep your hand on the projector for a long time when it is running.
- When you play a game by connecting a game console to a projector, it is recommended that you maintain a distance of more than four times the diagonal length of the screen.
- Make sure that the length of connecting cable is long enough. Otherwise, the product may fall causing personal injury or damage to the product.

 **CAUTION**

- Do not place a heavy object on the projector.
 - It may fall down and cause physical injury.
- Be careful to prevent the lens from heavy impact during transportation.
- Do not touch the lens.
 - The lens may be damaged.
- Do not use any sharp tools on the projector such as a knife or hammer, because this may damage the casing.
- In the event that no image appears on the screen, switch the projector off, unplug it from the wall outlet and contact an authorized service center.
 - Otherwise, this may cause a fire or an electric shock.
- Do not drop an object onto the projector or apply heavy pressure to it.
 - This may cause injury to persons or damage to the projector.
- The distance between your eyes and the screen must be around 5 - 7 times the diagonal length of the screen.
 - If you watch the screen at a close distance for a long time, your eye sight may become worse.

Cleaning

WARNING

- Do not spray the projector with water when cleaning. Do not allow water to go into the projector or do not allow it to get wet.
 - This may cause a fire or an electric shock.
- When there is smoke or a strange smell coming out from the projector or a foreign object falls into the projector, please switch it off and unplug it from the power outlet and contact an LG Electronics Service Center.
 - If not, this may cause a fire or an electric shock.
- Use an air spray or soft cloth or cotton swab moistened with a lens cleaning chemical or alcohol to remove dust or stains on the front projection lens.

CAUTION

- Contact your seller or the Service Center once a year to clean the internal parts of the projector.
 - If you do not clean the contaminated interior of the projector for a long time, there may be a fire or damage to the projector.
- When cleaning plastic parts such as the projector case, unplug the power first and wipe with a soft cloth. Do not spray with water or wipe with a wet cloth. When cleaning the plastic parts, such as the projector case, do not use cleanser, automobile or industrial shiner, abrasive or wax, benzene, alcohol, etc., which can damage the product.
 - This can cause fire, electric shock or product damage (deformation, corrosion and damage).

OTHERS

WARNING

- Only a qualified technician can disassemble or modify the projector. For inspection, adjustment, or repair, contact your seller or the Service Center.
 - Otherwise, this may cause a fire or an electric shock.
- Dispose of the used battery properly.
 - Otherwise, this may result in explosion or fire.
- The correct method of disposal may vary depending on your country or region. Dispose of the battery pack according to the appropriate instructions.
- Do not throw or disassemble the battery.
 - Otherwise, this may result in fire or explosion due to damage to the battery.
- Always use batteries approved and certified by LG Electronics.
 - Otherwise, this may result in fire or explosion.
- Store the battery away from metallic objects, such as keys and paper clips.
- Excess current may cause a rapid increase in temperature, resulting in fire or burns.
- Do not store the battery near any heat source, such as a heater.
 - This may result in fire or damage the product.
- Do not store it at temperatures higher than 60 °C or in high humidity.
- Keep the battery out of reach of children.
 - This may result in personal injury or damage to the product.

- Make sure that the battery is installed correctly.
- Incorrect battery replacement may cause fire.

CAUTION

- Unplug the power cord if the projector is not used for a long period.
 - Accumulated dust may cause overheating, an electric shock from corroded insulation and a fire from an electrical surge.
- Only use the specified type of battery.
 - Otherwise, this may cause an electric shock caused by overheating and leakage.
- Make sure you use the same type of battery when replacing. (Battery CR2032/3V)
 - In the case of a battery contact failure, the battery may drain quickly or the remote control may not work properly.

ANTENNA

Outdoor Antenna Grounding

- If an outdoor antenna is installed, follow the precautions below. An outdoor antenna system should not be located in the vicinity of overhead power lines or other electric light or power circuits, or where it can come in contact with such power lines or circuits as death or serious injury can occur. Be sure the antenna system is grounded so as to provide some protection against voltage surges and built-up static charges. Section 810 of the National Electrical Code (NEC) in the U.S.A. provides information with respect to proper grounding of the mast and supporting structure, grounding of the lead-in wire to an antenna discharge unit, size of grounding conductors, location of antenna discharge unit, connection to grounding electrodes and requirements for the grounding electrode.

Antenna grounding according to the National Electrical Code, ANSI/NFPA 70

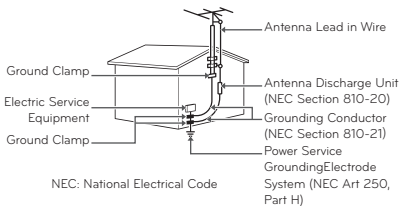

FCC NOTICE

Warning - Class B

(b) For a Class B Digital device or peripheral, the instructions furnished the user shall include the following or similar statement, placed in a prominent location in the text of the manual:

NOTE: This equipment has been tested and found to comply with the limits for a Class B digital device, pursuant to part 15 of the FCC Rules. These limits are designed to provide reasonable protection against harmful interference in a residential installation. This equipment generates, uses and can radiate radio frequency energy and, if not installed and used in accordance with the instructions, may cause harmful interference to radio communications. However, there is no guarantee that interference will not occur in a particular installation. If this equipment does cause harmful interference to radio or television reception, which can be determined by turning the equipment off and on, the user is encouraged to try to correct the interference by one or more of the following measures:

- Reorient or relocate the receiving antenna.
 - Increase the separation between the equipment and receiver.
 - Connect the equipment into an outlet on a circuit different from that to which the receiver is connected.
 - Consult the dealer or an experienced radio/TV technician for help.
- Any changes or modifications in construction of this device which are not expressly approved by the party responsible for compliance could void the user's authority to operate the equipment.

IC (CANADA)

Industry Canada Statement:

This device complies with RSS-210 of the Industry Canada Rules. Operation is subject to the following two conditions:

- 1) this device may not cause interference and
- 2) this device must accept any interference, including interference that may cause undesired operation of the device.

Avis d'Industrie Canada :

Cet appareil est conforme à la norme CNR-210 des règlements d'Industrie Canada. Son fonctionnement est sujet aux deux conditions suivantes :

- 1) Cet appareil ne doit pas provoquer d'interférences et
- 2) Cet appareil doit accepter toutes les interférences, y compris celles pouvant entraîner son dysfonctionnement.

IC Radiation Exposure Statement:

This equipment complies with IC radiation exposure limits set forth for an uncontrolled environment.

NOTE: THE MANUFACTURER IS NOT RESPONSIBLE FOR ANY RADIO OR TV INTERFERENCE CAUSED BY UNAUTHORIZED MODIFICATIONS TO THIS EQUIPMENT. SUCH MODIFICATIONS COULD VOID THE USER'S AUTHORITY TO OPERATE THE EQUIPMENT.

Avis d'Industrie Canada sur l'exposition aux rayonnements

Cet appareil est conforme aux limites d'exposition aux rayonnements d'Industrie Canada pour un environnement non contrôlé.

REMARQUE : LE FABRICANT N'EST PAS RESPONSABLE DES INTERFÉRENCES RADIOÉLECTRIQUES CAUSÉES PAR DES MODIFICATIONS NON AUTORISÉES APPORTÉES À CET APPAREIL. DE TELLES MODIFICATIONS POURRAIT ANNULER L'AUTORISATION ACCORDÉE À L'UTILISATEUR DE FAIRE FONCTIONNER L'APPAREIL.

Disposal of your old appliance

1. When this crossed-out wheeled bin symbol is attached to a product it means the product is covered by the European Directive 2002/96/EC.
2. All electrical and electronic products should be disposed of separately from the municipal waste stream through designated collection facilities appointed by your government or your local authorities.
3. The correct disposal of your old appliance will help prevent potential negative consequences for the environment and human health.
4. For more detailed information about disposal of your old appliance, please contact your city office, waste disposal service or the shop where you purchased the product.

**Disposal of waste
batteries/accumulators**

1. When this crossed-out wheeled bin symbol is attached to batteries/accumulators of Your product it means they are covered by European Directive 2006/66/EC.
2. This symbol may be combined with chemical symbols for mercury(Hg), cadmium(Cd) or lead(Pb) if the battery Contains more that 0.0005 % of mercury, 0.002 % of cadmium or 0.004 % of lead.
3. All batteries/accumulators should be disposed separately from the municipal waste stream via designated collection facilities appointed by the government or the local authorities.
4. The correct disposal of Your old batteries/accumulators will help to prevent potential negative consequences for the environment, animal and human health.
5. For more detailed information about disposal of Your old batteries/accumulators, please contact Your city office, waste disposal service or the shop where You purchased the product.

For USA**NOTE TO CABLE/TV INSTALLER**

This reminder is provided to call the CATV system installer's attention to Article 820 - 40 of the National Electric Code (U.S.A.). The code provides guidelines for proper grounding and, in particular, specifies that the cable ground shall be connected to the grounding system of the building, as close to the point of the cable entry as practical.

Contents

LICENSES	2	MY MEDIA	30
SAFETY INSTRUCTIONS	3	- Connecting USB Storage Devices	30
PREPARATION	13	- MOVIE LIST	32
Accessories	13	- PHOTO LIST	38
Optional Extras	14	- MUSIC LIST	40
Parts and Components	15	- FILE LIST	42
Installation	16	3D FUNCTION	44
- Installation Precautions	16	Before Watching 3D	44
- Projection Distance per Screen Size	17	- While Watching 3D	44
- How to Install the Projector On a Tripod	18	Requirements for Watching 3D Images	46
- Kensington Security System	18	- To Use DLP-LINK (DLP-Ready) Type Glasses	48
REMOTE CONTROL	19	Watching 3D Images	48
USING THE PROJECTOR	21	CUSTOMIZING SETTINGS	49
Connecting to an Antenna or Cable	21	SETUP Menu	49
- Connecting an Antenna or Basic Cable	21	PICTURE Settings	50
- Connecting a Cable Box	21	AUDIO Settings	53
Watching the Projector	22	CHANNEL Settings	54
- Turning on the Projector	22	TIME Settings	55
- Focus and Position of the Screen Image	22	LOCK Settings	56
- Watching the Projector	22	OPTION Settings	58
Managing Channels	23	MAKING CONNECTIONS	61
- Setting Up Channels	23	Connecting to an HD Receiver, DVD Player, or VCR	62
Using Additional Options	25	- HDMI Connection	62
- Adjusting Aspect Ratio	25	Connecting to a PC	62
- Using the Keystone Function	26	- RGB Connection	62
- Using the Input List	26	Connecting to the AV INPUT	63
- Blank Function	27	- Component Connection	64
Using the Quick Menu	27	Connecting to Headphones	64
ENTERTAINMENT	28	MAINTENANCE	65
Using WiDi	28	Cleaning the Projector	65
- Connecting to WiDi	28	- Cleaning the Lens	65
- WiDi (Wireless Display) Setup	29	- Cleaning the Projector Case	65
		SPECIFICATIONS	66

PREPARATION

Accessories

Check enclosed accessories.

The picture may be different from an actual product.

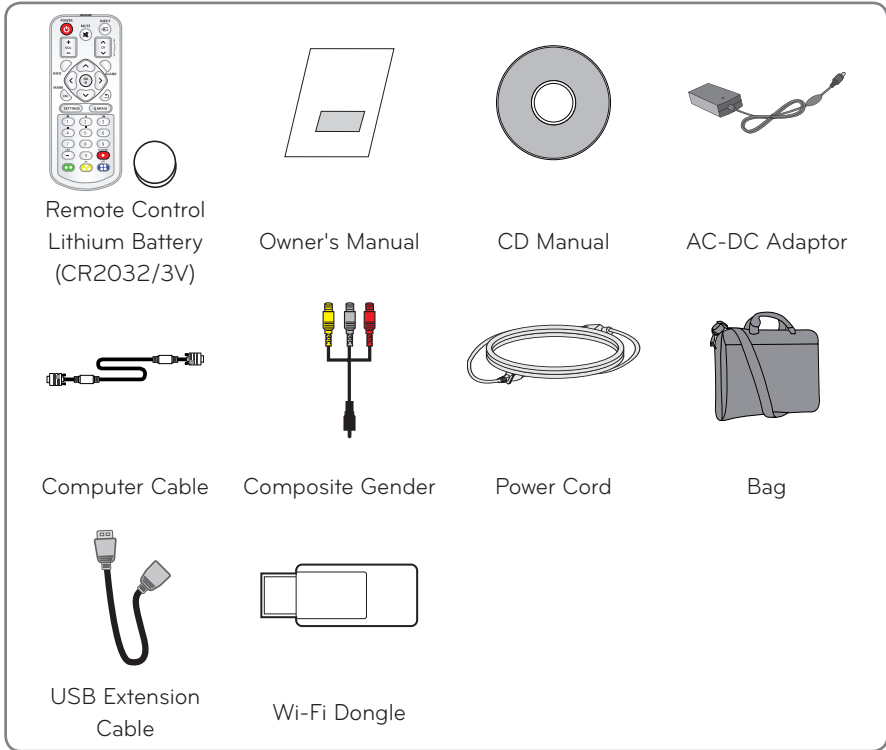

- When connecting a cable to the HDMI or USB port, it may not be connected properly if the size of jack to the USB/HDMI port is too big. Use a standard sized jack.

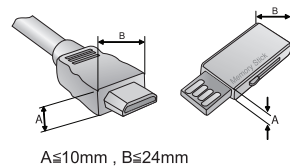

Optional Extras

To purchase optional extras, visit an electronics store or online shopping site or contact the retail store where you purchased the product.

Without prior notice, optional extras are subject to change in order to improve the performance of the product, and new accessories may be added.

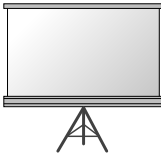

Projector Screen



Tripod



HDMI Cable



Video Cable



Audio Cable



3D Glasses
(DLP-LINK or DLP-Ready Type)



RGB to Component Cable



Component Cable



RF Cable

Parts and Components

* The projector is manufactured using high-precision technology. You may, however, see tiny black dots and/or bright colored dots (red, blue or green) that continuously appear on the projector screen. This is a normal result of the manufacturing process and does not indicate a malfunction. When powered on, the LED of the control panel turns on.

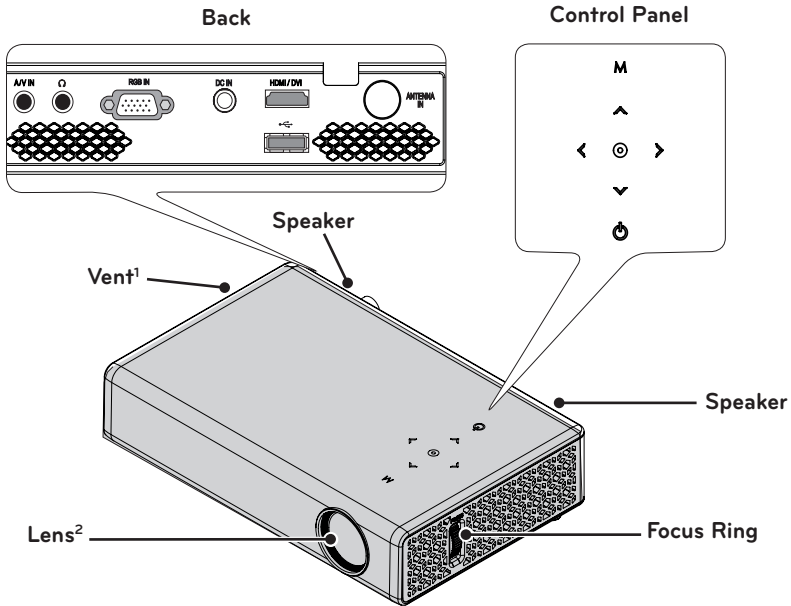

Button	Description
⏻ (Power)	Turns the projector on or off.
M (Menu)	Selects or closes menus.
⬆, ⬇, ⬅, ➡	Sets the function or moves the cursor.
⊙ (OK)	Checks present mode and saves function changes.

1 Due to the high temperature air coming out of the vents, do not get close to the vents.

2 Do not touch the lens when using the projector. The lens may be damaged.

Installation

Installation Precautions

- **Place the projector in a well-ventilated environment.**

- To prevent internal heat from building up, install the projector in a well-ventilated place.

Do not place anything near the projector as this may block the air vents. If the air vents are blocked, the internal temperature will increase.

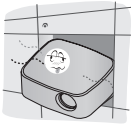

- Do not place the projector on a carpet or rug. Do not block any vents on the bottom and use the projector on a leveled solid surface.



- Be sure to prevent foreign objects such as paper debris from entering the projector.



- Leave an adequate open area (30 cm or more) around the projector.



- Do not place the projector in a hot or humid environment.
 - Do not place the projector in a hot, cold, or humid environment.
- Do not place the projector in a place where it will easily attract dust.
 - This may cause a fire.
- Do not remove any covers except for the lens cap. There is a high risk of electric shock.
- The projector is manufactured using high-precision technology. You may, however, see tiny black dots and/or bright colored dots (red, blue or green) that continuously appear on the projector screen. This is a normal result of the manufacturing process and does not indicate a malfunction.
- The remote control may not work in an environment where a lamp equipped with electronic ballasts or a three-wavelength fluorescent lamp is installed. Replace the lamp with an internationally standardized lamp for the remote control to work normally.

Projection Distance per Screen Size

- 1 Place the projector on a sturdy, level surface, together with the PC or audio/video source.
- 2 Place the projector at an appropriate distance from the screen. The distance between the projector and the screen determines the actual size of the image.
- 3 Position the projector so that the lens is set at a right angle to the screen. If the projector is not set at a right angle, the image on the screen will be tilted and the image quality will be poor. If the screen image is crooked, use the Keystone function.
- 4 Connect the power cords of the projector and the connected devices to the wall outlet.

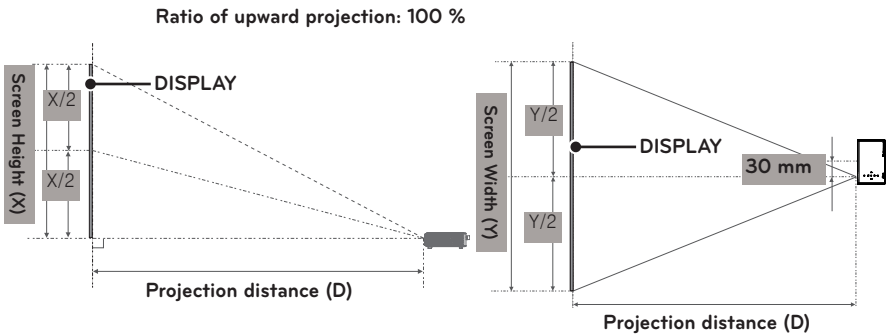

16:10 Screen			
Screen Size (mm)	Screen Width (Y) (mm)	Screen Height (X) (mm)	Projection Distance (D) (mm)
635	538	337	803
762	646	404	966
889	754	471	1130
1016	861	539	1293
1143	969	606	1456
1270	1077	673	1619
1397	1185	741	1783
1524	1292	808	1946
1651	1400	875	2109
1778	1508	943	2272
1905	1615	1010	2436
2032	1723	1077	2599
2159	1831	1145	2762
2286	1938	1212	2925
2413	2046	1279	3089
2540	2154	1347	3252

How to Install the Projector On a Tripod

- You can install this projector on a camera tripod as shown below.
- When stabilizing the tripod, we recommend using a locking bolt of standard size 4.5 mm or less. The maximum size allowed for the locking bolt is 5.5 mm. (If it is longer than the maximum allowed size, it may damage the projector.)

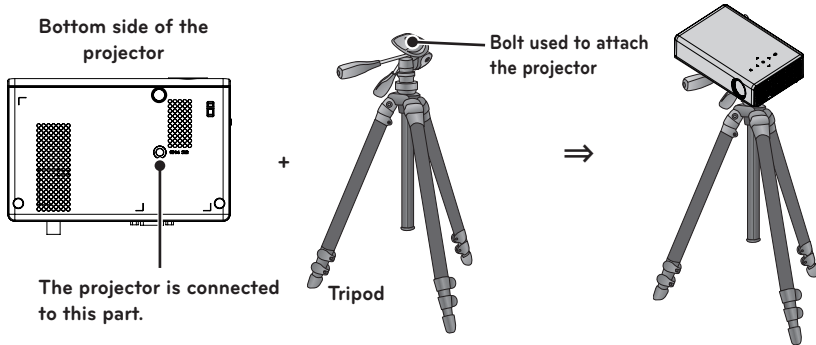

Kensington Security System

- This projector has a Kensington Security System Connector on the panel. Connect a Kensington Security System cable as below.
- For detailed installation and use of the Kensington Security System, refer to the user's guide included with the Kensington Security System set.
- The Kensington Security System is an optional item.
- What is Kensington?

Kensington is a company that sells security systems that prevent expensive electronic equipment such as a computer or laptop from being stolen.

Internet Homepage: <http://www.kensington.com>

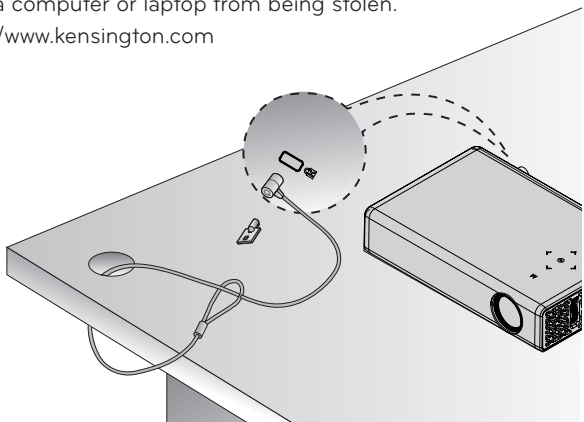

REMOTE CONTROL

Open the battery cover on the back of the remote control and insert the specified batteries as per instructions . The same type of batteries must be used.

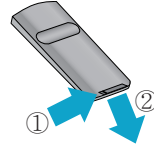

- POWER**
Turns the projector on or off.
- INPUT**
Changes the input source.
- MUTE**
Mutes all sounds.
- VOL +, -**
Adjusts the volume level.
- CH ^, v**
Changes the channel or page.
- PAGE**
Moves to the previous/next page.
- INFO**
Views the information of the current program and screen.
- BLANK**
Turns the projector screen on or off.
- Up/Down/Left/Right Buttons**
Sets the function or moves the cursor.
- OK**
Checks present mode and saves function changes.
- MARK**
Allows you to select optional functions.
- FAV**
Accesses your favorite channel list.
- ↶**
Returns to the previous level.
- SETTINGS**
Selects or closes menus.
- Q.MENU**
Accesses the quick menu.

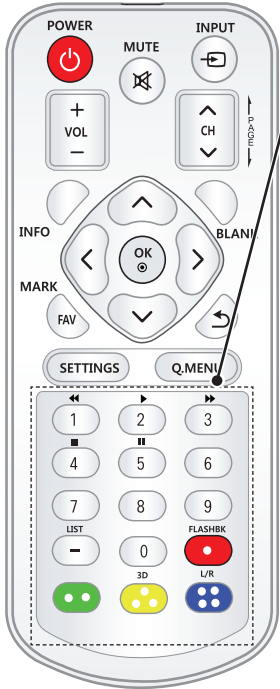

Number buttons

Enter a number.

Playback Control Buttons

Controls playback of **USB** mode.

LIST

Accesses the saved channel list.

- (Dash)

Inserts a dash between numbers such as 2 - 1 and 2 - 2.

FLASHBK

Tunes to the last channel viewed.

3D

Shows 3D images.

L/R

Switches left and right in 3D mode.

Color buttons

Access special functions in some menus.

NOTE

- When using the remote control, the optimal remote range is less than 3 meters (left/right) and within a 30 degree arc of the IR receiver.
- For seamless operation, do not block the IR receiver.
- When you carry the remote control in the portable bag, make sure that the buttons on the remote control are not pressed by the projector, cables, documents or any other accessories in the bag. Otherwise, it may significantly reduce the battery life.

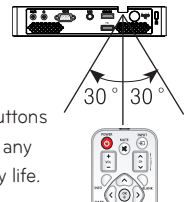

Using the PROJECTOR

Connecting to an Antenna or Cable

Connect an antenna, cable, or cable box to watch TV while referring to the following. The illustrations may differ from the actual items and a RF cable is optional.

Connecting an Antenna or Basic Cable

Connect the projector to a wall antenna socket with an RF cable (75 Ω).

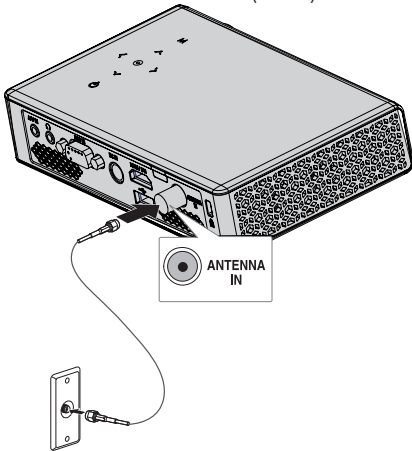

NOTE

- Use a signal splitter to use more than 2 projectors.
- Visit <http://lgknowledgebase.com> for more information about the antenna and cable connection. Search for antenna.

Connecting a Cable Box

Connect the projector to a cable box and the cable box to a wall antenna socket with 2 RF cables (75 Ω).

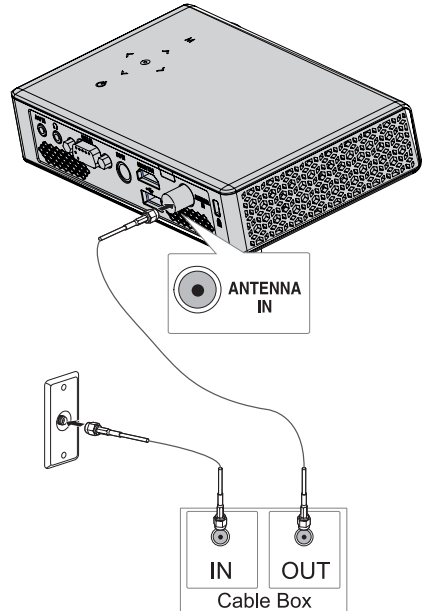

CAUTION

- Make sure not to bend the copper wire of the RF cable.

Copper wire

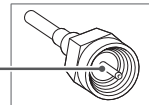

Complete all connections between the devices, and then connect the power cord to the power outlet to prevent damage to your projector.

Watching the Projector

Turning on the Projector

- 1 Connect the power cord correctly.
- 2 After waiting for a moment, press the **POWER** button on the remote control or the control panel.
(The light on the control panel will be turned on.)
- 3 In the Language Selection screen, select a language.
- 4 Select an input signal by using the **INPUT** button on the remote control.

Focus and Position of the Screen Image

When an image appears on the screen, check if it is in focus and fits the screen properly.

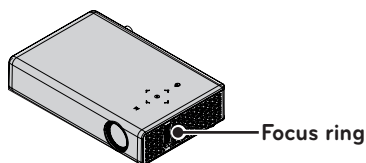

- To adjust the focus of the image, rotate the focus ring.

Watching the Projector

- 1 In Standby mode, press the **POWER** button to turn the projector on.
- 2 Press the **INPUT** button and select the input signal you want.
- 3 Control the projector using the following buttons while watching projector.

Button	Description
CH \wedge, \vee	Scrolls through saved channels.
LIST	Selects a channel on the saved or recent watched channel list.
0 - 9	Selects a channel by entering numbers.
VOL -, +	Adjusts the volume level.
MUTE	Mutes all sounds.
Q.MENU	Accesses the quick menu.
FLASHBK	Alternates between the last two channels selected.

- 4 To turn the projector off, press the **POWER** button.

Managing Channels

Setting Up Channels

Storing Channels

To store channels automatically,

- 1 Press **MENU** to access the menu.
- 2 Press the Navigation buttons to scroll to **CHANNEL** and press **OK**.
- 3 Press the Navigation buttons to scroll to **Auto Tuning** and press **OK**.
- 4 Select **Start** to start automatic tuning. The projector scans and saves available channels automatically.
- 5 When you are finished, press **SETTINGS**.

To store channels manually,

- 1 Press **MENU** to access the menu.
- 2 Press the Navigation buttons to scroll to **CHANNEL** and press **OK**.
- 3 Press the Navigation buttons to scroll to **Manual Tuning** and press **OK**.
- 4 Scroll through the channel types, and then add or delete channels.
- 5 When you are finished, press **SETTINGS**.



NOTE

- If the projector scans a blocked channel, you will be prompted to enter your password to keep the channel scanned.
- You can store up to 1000 channels. The number of channels that you can store differs depending on the broadcasting signal environment.
- The channels are stored in the order of DTV, TV, Cable DTV and Cable TV.

Editing Your Channel List

- 1 Press **MENU** to access the menu.
- 2 Press the Navigation buttons to scroll to **CHANNEL** and press **OK**.
- 3 Press the Navigation buttons to scroll to **Channel Edit** and press **OK**.
- 4 Edit channels using the following buttons.

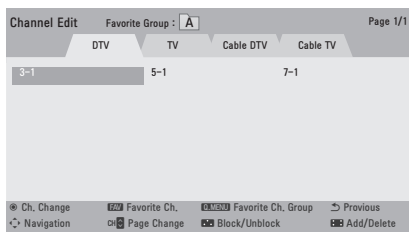

Button	Description
OK	Selects the highlighted channel to view.
^, V, <, >	Scrolls through channel types or channels.
FAV	Adds a favorite channel list.
CH	Moves to the previous or next page.
Q.MENU	Changes the favorite group.
Yellow	Block or unblock a channel.
Blue	Adds or deletes a channel. The deleted channel displays in blue.

- 5 When you are finished, press **SETTINGS**.

Favorite Channel Setup

- 1 Press **CH** or Number buttons to access to select your desired channel.
- 2 Press **FAV.** to access the **Favorite List**.
- 3 Press the **<, >** buttons to scrolls through channel group.
- 4 Press the **Yellow** button.

Favorite Channel List

- 1 Press **FAV.** to access the **Favorite List**.
- 2 Press the Navigation buttons to scroll to a channel.and press **OK**.

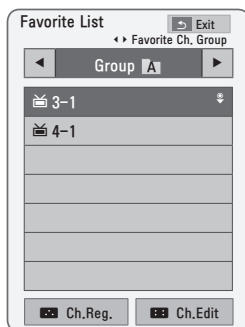

Button	Description
^, V	Scrolls through channels.
<, >	Scrolls through channel group.
CH	Moves to the previous or next page
Yellow	Register or cancel the current channel in favorite channel list.
Blue	Go to the "CHANNEL menu - Channel Edit".

Using Additional Options

Adjusting Aspect Ratio

You can also change the image size by pressing **Q.MENU** or **SETTINGS**.

! NOTE

- Some options may not be available depending on input signals.

- **FULL:** Changes to the full screen regardless of the aspect ratio.



- **16:9:** Resizes images to fit the screen width.



- **Just Scan:** Displays video images in the original size without cutting off the edges.



! NOTE

- If you select Just Scan, you may see image noises at the edge or edges of the screen.

- **Set By Program:** Displays images in the same aspect ratio as the original image.



- **4:3:** Resizes images to the 4:3 aspect ratio.



- **Zoom:** Enlarges an image to fit the screen width. The top and bottom of the image may be truncated.
 - Press the < or > button to zoom in or out of the image.
 - Press the ^ or v button to move the image.



- **Cinema Zoom:** Formats an image to the cinemascope ratio, 2.35:1. It ranges from 1 to 16.
 - Press the < or > button to zoom in or out of the image.
 - Press the ^ or v button to move the image.



! NOTE

- If you enlarge or reduce an image, the image may be distorted.

Using the Keystone Function

To prevent the screen image from becoming trapezoidal, Keystone adjusts the top and bottom width of the image if the projector is not set at a right angle to the screen.

Because the **Keystone** function may cause inferior screen image quality, use this function only when it is not possible to set up the projector at an optimal angle.

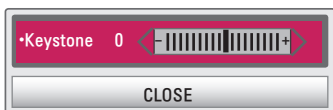

- 1 Press the **SETTINGS** button.
- 2 Press the \wedge , \vee , \lt or \gt button to select **OPTION** and press the **OK** button.
- 3 Press the \wedge , \vee , \lt or \gt button to select **Keystone** and press the **OK** button.
- 4 Press the \lt or \gt button to adjusted Keystone.
 - **Keystone** can be adjusted from **-40** to **40**.
- 5 Press the **OK** button after adjustment.

Using the Input List

Using the Input List

- 1 Press the **INPUT** button to access the input sources.
 - The connected input mode appears first. However, AV / Component input is always activated.

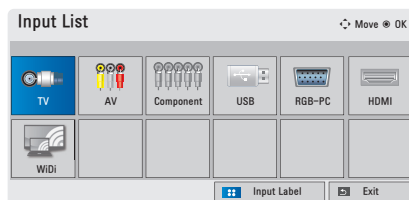

- 2 Select an input signal using the **INPUT** button and the projector is switched only to the connected input mode. You can use the \wedge , \vee , \lt or \gt button to switch between all the input modes.

Adding an Input Label

Displays which devices are connected to which input ports.

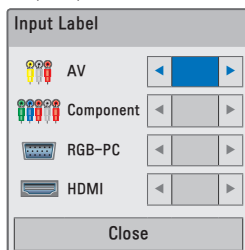

- 1 Press the **INPUT** button to access the input sources.
- 2 Press the **BLUE** button.
- 3 Use the \wedge or \vee button to scroll to one of the input sources.
- 4 Use the \lt or \gt button to select one of the input labels.

Blank Function

Using the Blank Function

This function may be effective when you need to draw attention during a meeting or training.

- 1 Press the **BLANK** button, and the screen is covered by the background color.

You can change the background color by referring to "Selecting a Blank Image".

- 2 Press any button to clear the blank function.

To cover the screen temporarily, press the **BLANK** button on the remote control.

Do not block the lens with any object while the projector is running.

It may become overheated and deformed or even cause a fire.

Selecting a Blank Image

- 1 Press the **SETTINGS** button.
- 2 Press the \wedge , \vee , $<$ or $>$ button to select **OPTION** and press the **OK** button.
- 3 Press the \wedge , \vee , $<$ or $>$ button to select **Blank Image** and press the **OK** button.
- 4 Use the \wedge , \vee button to move to the setting or option you want and press the **OK** button.

Using the Quick Menu

You can customize frequently used menus.

- 1 Press **Q.MENU** to access the quick menus.
- 2 Press the $<$ or $>$ button to scroll through the following menus and press **OK**.

Menu	Description
Aspect Ratio	Resizes an image.
PJT Mode	Turns the projected image upside down or flips it horizontally.
Picture Mode	Changes the picture mode.
Multi Audio	Changes the audio language (Digital signal)
SAP	Changes the MTS sound (Analog signal)
Sleep Timer	The projector is turned off at the preset time.
Clear Voice II	Makes the voice from the projector crisp and clear.
Del/Add	Edits the channels to add or delete the channel.
USB Device	Eject a USB device. The menu is displayed only when the USB device is connected.

- 3 Press the \wedge , \vee , $<$, or $>$ button to scroll through the following menus.

ENTERTAINMENT

Using WiDi

Connecting to WiDi

WiDi refers to Intel's Wireless Display technology.

If you have a notebook that supports Intel WiDi, you can use the projector as an eternal monitor without using a video cable.

WiDi requires a strong signal. If you experience interference, Use the USB Extension Cable provided with the Wi-Fi dongle.

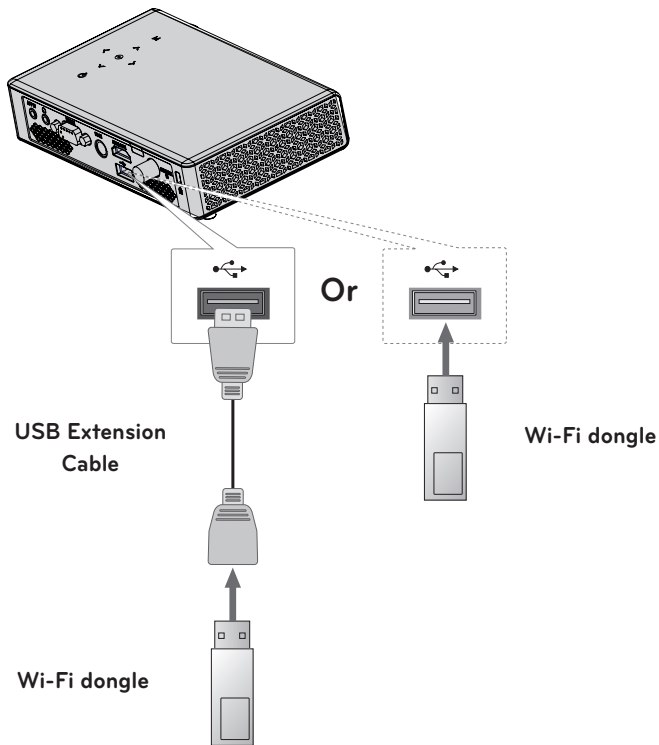

NOTE

- Do not remove the wireless dongle during WiDi operations.
- The picture above may look different from the actual product.
- An image from a PC may look different when projected on the screen.

WiDi (Wireless Display) Setup

- 1 Set the external input of the projector to WiDi.
- 2 Run the WiDi  program on your notebook.
- 3 After running the WiDi program on your notebook, a list will show all available devices that were detected. In the list, select the Projector you want and click Connect. Enter the 4 - digit number shown (a) on the screen (b) and then click Continue.

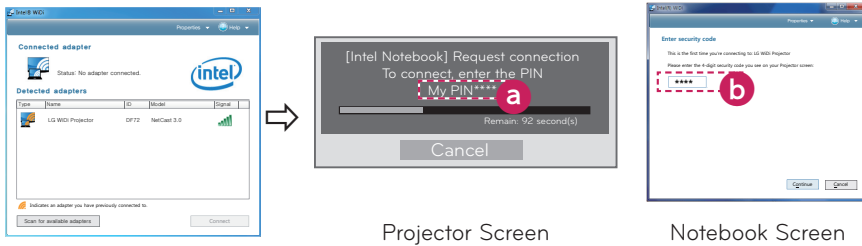

- 4 The Notebook screen will appear on the projector screen soon. Note that the wireless connection speed will affect the quality of the video displayed on the notebook. If the connection is poor, the intel WiDi connection may be lost or quality of the video may be poor.

- * For more information on Intel WiDi, visit <http://intel.com/go/widi>
- * Only the Input, OK, Volume, and Mute buttons on the remote control are available in WiDi mode.
- * The M (Menu) button on the Control Panel of the projector is used as the external input button during WiDi operation.
- * If you change the input signal while watching in WiDi mode, the WiDi connection will be disabled.

MY MEDIA

Connecting USB Storage Devices

Connect a USB memory stick as shown below.

When a USB storage device is connected, the USB adjustment screen appears. You cannot write or delete data on the USB storage device.

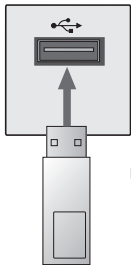

USB memory stick

To disconnect the USB storage device,

- 1 Press the **Q.MENU** button.
- 2 Use the **<** or **>** button to move to **USB Device** and press the **OK** button.
- 3 Remove the **USB device**.

NOTE

- After the USB storage device is disconnected, it cannot be read. Remove the USB storage device and connect it again.

Tips for Using USB Devices

- Only a USB storage device is recognizable.
- USB hubs are not supported.
- A USB storage device which uses its own driver may not be recognized.
- The recognition speed of a USB storage device will depend on each device.
- If a normal USB device does not work, disconnect and reconnect it. Please do not turn off the projector or unplug the USB device when the connected USB device is working. The USB device or stored files may be damaged.
- Please do not connect the USB storage device that has been manipulated on the PC. The projector may not operate properly or fail to play files. Use a USB storage device which contains normal music, photo, video, or document files.
- Please only use a USB storage device formatted as a FAT16, FAT32, or NTFS file system provided by Windows. In case a storage device formatted as a different utility program is not supported by Windows, it may not be recognized.
- Please connect power to a USB storage device which requires an external power supply. If not, the device may not be recognized.
- Please connect a USB storage device with a cable provided by the USB manufacturer. When you use a cable that is not provided by a USB manufacturer or an excessively long cable, the device may not be recognized.
- Some USB devices may not be supported or will not work properly.
- If the length of a folder or file is too long, the folder or file may not be recognized properly.
- The files in a USB storage device are sorted in the same way as Windows XP. Up to 100 English characters for a file name are allowed.
- The data of a USB device may be damaged, so it is recommended to backup any important files. Because a user is responsible for data management, the manufacturer is not responsible.
- It is recommended to use a USB memory stick which is 32 GB or less and a USB hard disk which is 1 TB or less. Any device with more than the recommended capacity may not work properly.
- If a USB storage device is not working properly, disconnect it and connect it again.
- If a USB external hard disk with the power saving function does not work, turn the hard disk off and on again to make it work properly.
- USB storage devices below USB 2.0 are supported as well. However, they may not work properly in the movie list.

MOVIE LIST

In the Movie List, you can watch movies stored on the connected USB device.

Tips for Playing Video Files

- Some subtitles created by a user may not work.
- Some special characters are not supported in subtitles.
- HTML tags are not supported in subtitles.
- Time information in a subtitle file should be arranged in ascending order to play the subtitle properly.
- Changing font and color in subtitles is not supported.
- A language which is not specified in the subtitle languages is not supported.
- Subtitle files of 1 MB or larger are not supported.
- The screen may suffer temporary interruptions (image stoppage, faster playback, etc.) when the audio language is changed.
- A damaged video file may not be played properly, or some functions may not be available.
- Video files created with some encoders may not be played properly.
- Either audio or video may only be supported depending on the video or audio packet structure of a video file.
- Video files with higher resolution than the maximum supported for each frame may not be played properly.
- Video files in formats other than the ones specified above may not be played properly.
- Streaming files which include GMC (Global Motion Compensation) or Qpel (Quarterpel Motion Estimation) is not supported.
- Up to 10,000 sync blocks are supported in the subtitle file.
- Seamless playback is not guaranteed for files encoded level 4.1 or higher in H.264/AVC.
- DTS audio codec is not supported.
- Video files larger than 30 GB (Giga-bytes) are not supported.
- Playing a video via a USB connection that does not support high speed may not work properly.
- A video file and its subtitle file must be located in the same folder. A video file name and its subtitle file name must be identical in order to display the subtitle properly.
- While watching a video using the movie list function, you cannot adjust the picture mode.
- Trick Mode does not support other functions than ► if video files do not have index information.
- When playing a video file using network, the Trick mode is limited to 2X speed.
- Video file names that contain special characters may not be playable.

Supported Video Formats

File Extensions	Audio/Video	Codec	Profile/Level Support
.asf .wmv	Video	VC-1 Advanced Profile	Advanced Profile @ Level 3 (e.g.720p60, 1080i60, 1080p30) Only streams compliant to SMPTE 421M VC-1 standard are supported.
		VC-1 Simple and Main Profiles	Simple Profile @ Medium Level (e.g.CIF,QVGA) Main Profile @ High Level (e.g.1080p30) Only streams compliant to SMPTE 421M VC-1 standard are supported.
	Audio	WMA Standard	
		WMA 9 Professional	
.divx .avi	Video	Divx3.11	
		Divx4 Divx5 Divx6	Advanced Simple Profile(720p/ 1080i)
		XViD	Advanced Simple Profile(720p/ 1080i)
	Audio	MPEG-1 Layer I,II	
		MPEG-1 Layer III (MP3)	
		Dolby Digital	
		WMA Standard	
		WMA 9 Professional	
		DTS	Korea only
.mp4 .m4v	Video	H.264 /AVC	Main Profile @Level 4.1 High Profile @Level 4.1 (e.g.720p60, 1080i60, 1080p30)
		MPEG-4 Part 2	Advanced Simple Profile(720p/ 1080i)
	Audio	HE-AAC	HE-AAC-LC and HE-AAC
.mkv	Video	H.264 /AVC	Main Profile @Level 4.1 High Profile @Level 4.1 (e.g.720p60, 1080i60, 1080p30)
	Audio	HE-AAC	HE-AAC-LC and HE-AAC
		Dolby Digital	
		DTS	Korea only
.ts .trp .tp	Video	H.264 /AVC	Main Profile @Level 4.1 High Profile @Level 4.1 (e.g.720p60, 1080i60, 1080p30)
		MPEG-2	Main Profile @High Level (e.g.720p60, 1080i60)
	Audio	MPEG-1 Layer I,II	
		MPEG-1 Layer III (MP3)	
		Dolby Digital	
		HE-AAC	HE-AAC-LC and HE-AAC
.vob	Video	MPEG-1	
		MPEG-2	Main Profile @High Level (e.g.720p60, 1080i60)
	Audio	Dolby Digital	
		LPCM	
		MPEG-1 Layer I,II	
.mpg .mpeg .mpe	Video	MPEG-1	
	Audio	MPEG-1 Layer I,II	Only streams compliant configured properly for TS, PS or ES

Supported Audio Files

No	Audio Codec	Bit rate	Sampling rate	Remark
1	MP3	32 kbps - 320 kbps	32 kHz - 48 kHz	DTS Audio codec is Korea only.
2	AC3	32 kbps - 640 kbps	32 kHz, 44.1 kHz, 48 kHz	
3	MPEG	32 kbps - 448 kbps	32 kHz - 48 kHz	
4	AAC,HEAAC	24 kbps - 3844 kbps	8 kHz - 96 kHz	
5	CDDA	1.44 kbps	44.1 kHz	
6	LPCM	1.41 Mbps - 9.6 Mbps	Multi-channel : 44.1 kHz, 88.2 kHz/ 48 kHz, 96 kHz Stereo : 176.4 kHz, 192 kHz	

Browsing Movie List

Play a video file stored from a connected device.

- 1 Connect a USB storage device.
- 2 Press the **SETTINGS** button.
- 3 Accesses the **MY MEDIA**.
- 4 Use the \wedge , \vee , $<$ or $>$ button to select **Movie List** and press the **OK** button.
- 5 Use the \wedge , \vee , $<$ or $>$ button to select the file you want and press the **OK** button.

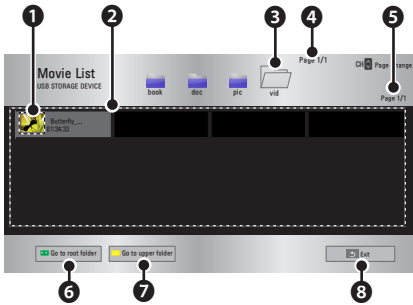

	Description	
1	Thumbnails	
	Abnormal file	
	File not supported	
2	File List	
3	Moves to the upper level folder.	
4	Current page/Total no. of folder pages	
5	Current page/Total no. of file pages	
6	Moves to the top level folder.	
7	Moves to the upper level folder.	
8	Exit Movie List.	

- 6 Control playback by using the following buttons.



Setting	Description
$\blacktriangleleft \blacktriangleright$	Shows the current playing position. Use $<$, $>$ buttons to move forward or backward.
■	Stops playing and returns to Movie List.
\blacktriangleright	Returns to normal playback.
	Pauses the media player. If no button is pressed on the remote control for 10 minutes after pausing, the playback is restarted.
	$ \blacktriangleright$
$\blacktriangleleft \blacktriangleright \blacktriangleleft \blacktriangleright$	Whenever this button is pressed, the playback speed is changed. : x2, x4, x8, x16, x32
	You can use the Energy Saving mode.
Option	A pop-up window will appear.
Hide	Hides the playback bar. Press the OK button to make it appear.
Exit	Returns to the Movie List screen.

Options for Movie List

- 1 Press the **Q.MENU** button.
- 2 Use the \wedge or \vee button to move to a desired option and press the **OK** button.
- 3 Use \wedge , \vee , $<$ or $>$ button to set up each item.

Set Video Play.

Setting	Description
Picture Size	<p>Selects the size of a playback screen.</p> <ul style="list-style-type: none"> • Full: Files are played in full screen mode according to the aspect ratio of video. • 16:9: Displays the video with the aspect ratio of 16:9. • Original: Displays the video in the original aspect ratio.
Audio Language	<p>Allows you to select the language you want for the file with multiple audio tracks. This option is not available if the file has only one audio track.</p>
Subtitle Language	<p>The subtitle can be turned on or off.</p> <ul style="list-style-type: none"> • Language: One of any of the available languages can be selected. • Code Page: A character set used for a subtitle can be selected. <p>By default, the subtitle is displayed in a language configured in OPTION → Menu Language.</p>

Setting	Description
Subtitle Language	<ul style="list-style-type: none"> • Speed: If a subtitle is not synchronized with its video, you can adjust its speed at 0.5 sec unit. • Position: Moves the location of a subtitle. • Size: Changes the subtitle font size.
Repeat	<p>Turns the repeat function on or off.</p> <p>When it is set to off, the next file can be played sequentially if the file name is similar.</p>

• Subtitle Language

Subtitle Language	Language
Latin1	English, Spanish, French, German, Italian, Swedish, Finnish, Dutch, Portuguese, Danish, Romanian, Norwegian, Albanian, Gaelic, Welsh, Irish, Catalan, Valencian
Korean	Korean

PICTURE Settings

You can change video settings.

AUDIO Settings

You can change audio settings.

Registering the DivX code

Please check your DivX code. For more information on the registration process, visit www.divx.com/vod. After registration, you can enjoy DivX VOD content protected by the DivX DRM code.

- 1 Press **SETTINGS** button to enter Setup menu.
- 2 Move to **OPTION** and press **DivX(R) VOD**.

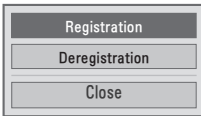

- 3 Press the \wedge or \vee button to move to **Registration** and press the **OK** button.

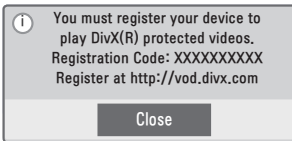

- 4 Check the **DivX registration code**.

! NOTE

- You cannot use DivX registration codes assigned to other devices. Make sure to use the DivX registration code assigned to your device.
- The video or audio files that are not converted by the standard DivX codec may be corrupted or not be played.

To deregister the DivX code

Use the DivX deregistration code to deactivate the DivX DRM function.

- 1 Press **SETTINGS** button to enter Setup menu.
- 2 Move to **OPTION** and press **DivX(R) VOD**.
- 3 Use the \wedge or \vee button to go to **Deregistration** and press the **OK** button.

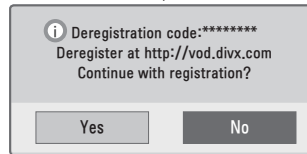
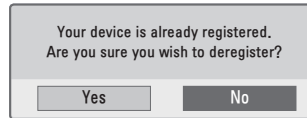

- 4 Select **Yes**.

! NOTE

- What is DRM [Digital Rights Management]? This is a technology and service that prevents the illegal use of digital media to protect the benefits and rights of the copyright owner. Files can be played after the license is verified through an online method, etc.

PHOTO LIST

You can see the photos stored on a connected device.

Supported Photo Files

PHOTO (*.JPEG)

Baseline: 64-pixel (width) x 64-pixel (height) - 15360-pixel (width) x 8640-pixel (height)



Progressive: 64-pixel (width) x 64-pixel (height) - 1920-pixel (width) x 1440-pixel (height)

- Only JPEG files are supported.
- Non-supported files are displayed in the form of an icon.
- An error message is displayed for corrupted files or file formats that cannot be played.
- Corrupted files may not be displayed properly.
- It may take some time to view high-resolution images in full screen.

Browsing Photo List

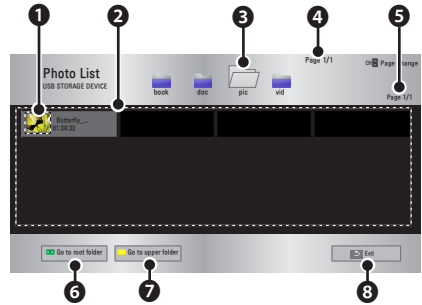
- 1 Connect a **USB storage device**.
- 2 Press the **SETTINGS** button.
- 3 Accesses the **MY MEDIA**.
- 4 Use the \wedge , \vee , \lt or \gt button to select **Photo List** and press the **OK** button.
- 5 Use the \wedge , \vee , \lt or \gt button to select the file you want and press the **OK** button.



	Description
1	Thumbnails Abnormal file 
	File not supported 
2	File List
3	Moves to the upper level folder.
4	Current page/Total no. of folder pages
5	Current page/Total no. of file pages
6	Moves to the top level folder.
7	Moves to the upper level folder.
8	Exit

6 Control playback by using the following buttons.



Setting	Description
Hide	Hides the menu on the full size screen. <ul style="list-style-type: none"> To see the menu, press the OK button on the remote control.
Exit	Exit from full screen photo view.

Setting	Description
	Selects the previous or next photo.
Slide-show	All photos are displayed during slide show. <ul style="list-style-type: none"> Set the time interval of the slide show in Option → Set Photo View menu.
BGM	You can listen to music while viewing photos in full size. <ul style="list-style-type: none"> Set the BGM in Option → Set Photo View menu.
	Rotates photos. <ul style="list-style-type: none"> Rotates a photo 90°, 180°, 270°, 360° clockwise. Photos cannot be rotated if their width is greater than the height of the max. supported resolution.
	You can move between screens using the navigation buttons. Press the blue button to enlarge the image.
	You can use the Energy Saving mode.
Option	A pop-up window will appear.

Options for Photo List

- 1 Press the **Q.MENU** button.
- 2 Use the \wedge or \vee button to move to a desired option and press the **OK** button.
- 3 Use \wedge , \vee , $<$ or $>$ button to set up each item.

Set Photo View.

Setting	Description
Slide speed	Selects a slideshow speed.
BGM (Background Music)	Selects a music folder for the background music. <ul style="list-style-type: none"> • You cannot change the music folder while the background music is playing. • For background music, only the folder from the same device can be selected.

PICTURE Settings

You can change video settings.

AUDIO Settings

You can change audio settings.

MUSIC LIST

You can play audio files stored on the connected device.

Supported Music Files

*.MP3



Bit rate range 32 Kbps - 320 Kbps

- Sampling rate MPEG 1 Layer 3:
32 kHz, 44.1 kHz, 48 kHz
- Sampling rate MPEG 2 Layer 3:
16 kHz, 22.05 kHz, 24 kHz

Browsing Music List

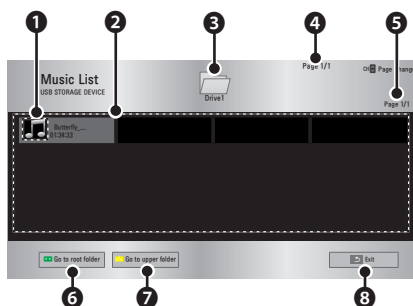
- 1 Connect a **USB storage device**.
- 2 Press the **SETTINGS** button.
- 3 Accesses the **MY MEDIA**.
- 4 Use the \wedge , \vee , $<$, $>$ button to select **Music List** and press the **OK** button.
- 5 Use the \wedge , \vee , $<$ or $>$ button to select the file you want and press the **OK** button.



Description	
①	Thumbnails
	Abnormal file 
	File not supported 
②	File List
③	Moves to the upper level folder.
④	Current page/Total no. of folder pages
⑤	Current page/Total no. of file pages
⑥	Moves to the top level folder.
⑦	Moves to the upper level folder.
⑧	Exit

6 Control playback by using the following buttons.

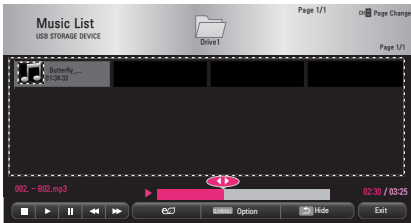

Setting	Description
◀▶	Changes the playing position.
■	Stops playing.
▶	Returns to normal playback.
	Pauses the media player.
◀▶	Plays the previous/next file.
⏻	You can use the Energy Saving mode.
Option	Sets up the options of Music List.

Setting	Description
Hide	Hides the playback bar. <ul style="list-style-type: none"> Press the OK button to make the playback bar appear.
Exit	Returns to the Music List screen.

Options for Music List

- 1 Press the **Q.MENU** button.
- 2 Use the \wedge or \vee button to move to a desired option and press the **OK** button.
- 3 Use \wedge , \vee , $<$ or $>$ button to set up each item.

Set Audio Play.

Setting	Description
Repeat	Selects repeat play.
Random	Selects random play.

AUDIO Settings

You can change audio settings.

FILE LIST

You can see document files stored on a connected device.

Supported File Formats

XLS, DOC, PPT, TXT, XLSX, PPTX, DOCX, PDF, Microsoft Office 97/ 2000/ 2002/ 2003/ 2007 Adobe PDF 1.0/ 1.1/ 1.2/ 1.3/ 1.4

- File Viewer realigns a document, so it may look different from what is displayed on a PC.
- For documents that include images, the resolution may look lower during the realigning process.
- If the document volume is big or it has many pages, it may take longer to load the document.
- Unsupported fonts may be replaced by other fonts.
- The file viewer may not open for Office documents that contain many high resolution images. In that case, reduce the image file size, save it on a USB storage device and run the file viewer again or connect your PC to the projector and open the file on your PC.

- 5 Use the \wedge , \vee , \lt or \gt button to select the file you want and press the OK button.

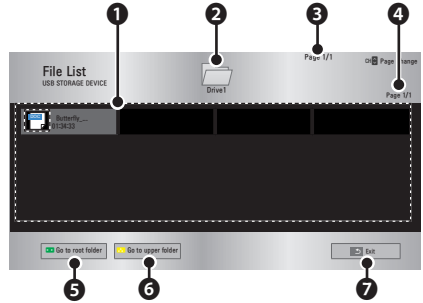

	Description
1	File List
2	Moves to the upper level folder.
3	Current page/Total no. of folder pages
4	Current page/Total no. of file pages
5	Moves to the top level folder.
6	Moves to the upper level folder.
7	Exit

Browsing File List

- 1 Connect a **USB storage device**.
- 2 Press the **SETTINGS** button.
- 3 Accesses the **MY MEDIA**.
- 4 Use the \wedge , \vee , \lt or \gt button to select **File List** and press the **OK** button.

6 Control playback by using the following buttons.

- Click **Go Page** then the pop-up window for selecting the number of page appears.
- Input the page to move to the page you want.
- Press the volume button to zoom in or zoom out.
 1. Press **OK**.
 2. Press the **Up/Down/Left/Right** buttons to move to Go Page or Zoom.

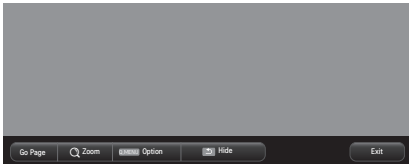

Setting	Description
Go Page	Moves to the page you want. Use the Up/Down/Left/Right buttons to select a page and press the OK button.
Zoom	Views the photo in full mode or original mode.
Option	Sets up the options of File Viewer.
Hide	Hides the menu. <ul style="list-style-type: none"> • Press the SETTINGS button to make it appear.
Exit	Returns to the File Viewer screen.

Set FileViewer Option

Setting	Description
Single Page Loading	On Loads and displays pages one by one. The initial loading time is short but a content-heavy page may be displayed slowly.
	Off Loads all pages of a file to memory before it starts to display them. The initial loading time is long but you can navigate pages quickly after loading is complete. If a file is too large, it may fail to load all the pages.
Image Quality	You can set the quality of the image included in the document. The following three options are available for the image quality: High, Medium, Low. Higher the image quality, lower the display time.
Document Align	Selects initial document align method.

File View settings are default, so close the currently opened document to apply changes to the new document, if any.

3D FUNCTION

3D technology uses different video frames for each eye to add depth to the video.

Before Watching 3D

While Watching 3D

WARNING

- If you view 3D images too closely for a long period of time, it may cause blurred vision.
- If you watch videos or a game screen for a long time with 3D glasses on, you may experience dizziness or eye fatigue.
- If you are pregnant, a senior citizen, intoxicated, have heart problems, or easily feel motion sickness, we recommend that you do not watch 3D images.
- Because 3D images can be recognized as real, some viewers may get surprised or overexcited.
- Do not watch 3D images near fragile objects or any objects that can be knocked over easily.
- Take care not to injure yourself as you may subconsciously try to move away from the life-like 3D images.
- Prevent children of 5 years or younger from watching a 3D video. It may impair the development of their eyes.

- **Warning about photosensitivity seizures**

- Some users may experience a seizure or other abnormal symptoms when they are exposed to a flashing light or particular pattern from a video game or movie. If anyone in your family has a history of epilepsy or has ever experienced any kind of seizure, please consult your doctor before viewing 3D images.

If you experience one of the following symptoms while watching a 3D video, stop watching the 3D video immediately and take a rest.

- Dizziness, twitching of the eye or facial muscles, involuntary movements, cramp, loss of consciousness, confusion, loss of sense of direction, or nausea. If the symptom does not disappear, please consult your doctor.

- You can reduce the risk of photosensitive seizures by taking the following preventive measures.

- Take a rest of 5 - 15 mins. for every 1 hour of viewing.
- If vision varies between each eye, correct the variation before beginning to watch a 3D video.
- Ensure that the 3D video is directly in front of you, at eye level.
- You should stop watching if you experience a headache, fatigue or dizziness.
- Do not view 3D images when you are tired or ill.

⚠ CAUTION

- Extra special care is required for children watching a 3D video.

When Watching 3D Video

- Watch 3D images within the optimum viewing angle and distance.
- If you are outside the viewing angle or distance, you may not be able to watch 3D images. You cannot view 3D images when you lie down.
- You may see left and right images overlapped during projector initialization after it is powered on. It may take some time for optimization.
- It may take some time for the 3D image look normal after you turn your eyes away from the screen and look back at the 3D image.
- It may flicker slightly while watching 3D images under a 3 wavelength lamp fluorescent light (50 Hz - 60 Hz) or near windows. If so, it is recommended to block the sun light with a curtain and to dim the lights.
- The 3D glasses must be DLP-LINK (DLP Ready) type.
- You may not be able to watch 3D properly if there is an obstacle between the projector and 3D glasses.
- Install the 3D projector as far as possible from other devices.

Please check the following when using**3D glasses.**

- Do not use 3D glasses as ordinary glasses, sunglasses or protective goggles.
 - If you do so, this may cause injury.
- Do not store 3D glasses in very hot or very cold conditions. If you do, this may cause them to become distorted. Do not use distorted glasses.
- Do not drop 3D glasses or allow them to come into contact with other objects.
 - This can result in damage to the product.
- The lenses of 3D glasses are easily scratched. Use a soft clean cloth when cleaning them.
 - Foreign particles on the cloth may cause scratches.
- Do not scratch the surface of the 3D glasses' lenses with sharp objects or wipe them with chemicals.
 - If the lenses get scratched, images may not look normal when viewing 3D.
- Please use 3D glasses certified by LG Electronics.

Requirements for Watching 3D Images

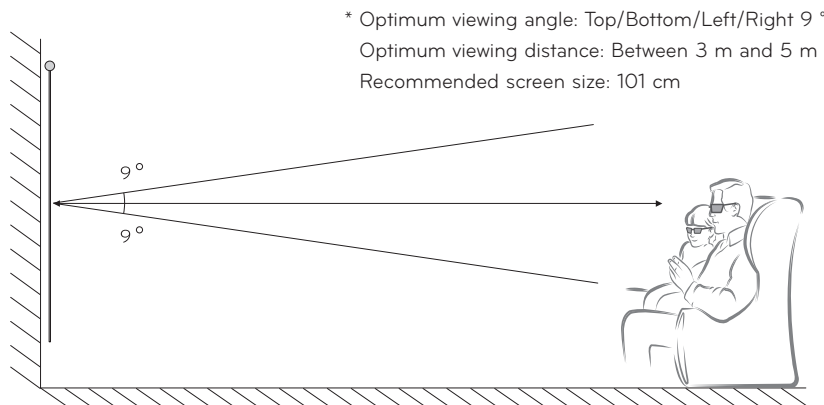

- * Basically, Watching 3D videos should be done in dark room environments only.
- * For 3D watching, set the energy saving mode to Minimum.



NOTE

- The pairing with the DLP-LINK glasses is affected by the intensity of light reflected from the screen. Therefore, the pairing with DLP-LINK glasses may not work properly if the light reflected from the screen is not bright enough, such as when the surrounding area is bright, the screen is big, or the maximum energy saving mode is enabled.
- Some menus may not work while playing a 3D video.
- You can only watch a 3D video properly when the 3D video format option has been selected on the projector.

- 1 Please check the minimum system requirements for your computer. Minimum requirements are as follows:

Microsoft® Windows® XP, Vista 32/64 bit ,Windows 7 32/64 bit

Intel® Core 2 Duo or AMD Athlon™ X2 CPU or higher

More than 1 GB of system memory (2 GB recommended)

Free space of 100 MB or more

DirectX 9 or higher

Video card should support 120 vertical frequency (Hz).

Recommended video card requirements

- Graphic Processor speed 700 MHz higher

- Memory 512 MB higher

- A laptop equipped with the chipsets above can be used but it may not work properly.

- 2 Set the video output to XGA 120 Hz and play a video file using a video player that supports 3D output.

The following video players support 3D output: Stereoscopic Player, nVidia 3D Vision, and TriDef 3D.

For more information on the players above, please visit their websites at:

www.3dtv.com

www.nvidia.co.kr

www.tridef.com

To Use DLP-LINK (DLP-Ready) Type Glasses

- 1 While watching 3D images from the projector, press the button on the glasses.
- 2 When you press the button, the glasses flicker to be synchronized with the 3D images. (The flickering is a unique operation method of DLP-LINK type glasses. It may be different depending on the glasses type.)
- 3 If the glasses flicker or problems occur while watching 3D, first turn the lights off to make the room darker. Contact your projector seller for queries about the glasses.

Supported 3D input formats

Input	Signal	Resolution	Vertical Frequency (Hz)	Supported 3D Formats
HDMI	XGA	1024 x 768	120	Frame Sequential / Frame Alternative
RGB-PC	XGA	1024 x 768	120	Frame Sequential / Frame Alternative

- The resolution supporting 3D mode is 1024 x 768 for HDMI and RGB input.
- Some menus may not work in 120 Hz input.









Watching 3D Images

- 1 Play supported 3D video titles.
- 2 For RGB-PC, you must press "**SETTINGS → PICTURE → Screen (RGB-PC) → Auto Config.**" on the remote control before watching 3D.
- 3 Press the **3D** button.
- 4 While watching 3D images from the projector, press buttons on the glasses.
- 5 Press the **L/R** button to switch the playing direction of an image. Select a screen with better 3D display quality.
 - If you press the **3D** button during viewing, it returns to 2D.
- 6 If a 2D image is displayed on the 16:9 screen, a 3D image is also displayed at the aspect ratio of 16:9. For ratios other than 16:9, a 3D image is displayed in 4:3.
 - You cannot change the screen size for 3D images.

CUSTOMIZING SETTINGS

SETUP Menu

- 1 Press the **SETTINGS** button.
- 2 Use the \wedge , \vee , $<$ or $>$ button to select a desired item and press the **OK** button.
- 3 Use the \wedge , \vee , $<$ or $>$ button to set up a desired item and press the **OK** button.
- 4 When you finished, press **SETTINGS**.

Menu		Description
	PICTURE	Adjusts the image quality for optimal viewing.
	AUDIO	Adjusts the sound quality and volume level.
	CHANNEL	Sets up and edit channels.
	TIME	Sets the time and time-related features.
	LOCK	Locks or unlocks channels and programs.
	OPTION	Customizes the general settings.
	INPUT	Selects the desired input source.
	MY MEDIA	Accesses photo, music, movie, and document files.

PICTURE Settings

- 1 Press the **SETTINGS** button.
- 2 Use the **^**, **v**, **<** or **>** button to select **PICTURE** and press the **OK** button.
- 3 Use the **^**, **v**, **<** or **>** button to set up a desired item and press the **OK** button.
 - To return to the previous menu, press the **↶** button.

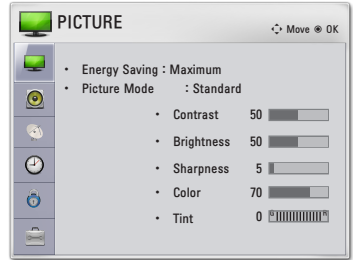

The available picture settings are described as follows.

Setting	Description
Energy Saving	Reduces the power consumption by adjusting the screen brightness.
Picture Mode	Selects one of the preset images or customizes options in each mode for the best screen performance. You are also able to customize advanced options of each mode.
	Mode
	Vivid Maximizes the visual effect of video. Displays a crystal clear picture by enhancing contrast, brightness, and sharpness.
	Standard Has the contrast, brightness and sharpness at normal levels.
	Cinema Optimizes the image for movie.
	Sport Optimizes the image for sports by emphasizing primary colors and dynamic actions.
	GAME Optimizes the image for playing games on fast-moving screens.
Expert 1/2 Adjusts the detailed image settings.	
CON-TRAST	Increases or decreases the gradient of the video signal.
BRIGHT-NESS	Adjusts the base level of the video signal to make the image brighter or darker.
Sharpness	Adjusts the level of sharpness in the edge between the light and dark areas of the picture. The lower the level is, the softer the image looks.
Color	Adjusts the intensity of all colors.
Tint	Adjusts the balance between red and green levels.
Advanced Control	Customizes the advanced settings.
Picture Reset	Restores the options of each mode to the factory default.

Setting	Description
Aspect Ratio	Changes the image size to view images at its optimal size.
Screen (RGB-PC)	Adjusts the picture quality of RGB-PC input.
	Option
Resolution	Available resolutions are 768 resolution (1024 x 768/ 1280 x 768/ 1360 x 768, 60 Hz) and 1050 resolution (1400 x 1050/ 1680 x 1050, 60 Hz).
Auto Config.	Provides optimized picture quality by automatically calibrating the mismatch of horizontal width and picture shake caused by clashes between the internal settings of the projector and various PC graphic signals. <ul style="list-style-type: none"> You can also use the AUTO button on the remote control.
Position	Moves the image up/down/left/right.
Size	Changes the screen size.
Phase	Makes the picture look clear by removing horizontal noise.
Reset	Restores all the settings to the factory default.

Advanced Control

Setting	Description
Dynamic Contrast	Adjusts the contrast to keep it at the best level according to the brightness of the screen.
Dynamic Color	Adjusts screen colors so that they look natural.
Clear White	Makes the white area of screen look brighter and whiter.
Skin Color	Detects the skin area of image and adjusts it to render a natural skin color.
Noise Reduction	Reduces image noise.
Digital Noise Reduction	This option reduces the noise produced while creating digital video signals.
Gamma	Sets a gradation curve between video input and output signal.
Black Level	Compensates the brightness and contrast of a screen to balance with the black level of the video input. Not available for RGB-PC.
Real Cinema	Provides the optimal picture quality for watching a movie.
Color Gamut	Selects the range of colors to display. <ul style="list-style-type: none"> Standard: Displays the original colors of an input signal regardless of the display features. Wide: Sets to use the rich colors of the display.

Setting	Description
Edge Enhancer	Provides much sharper and clearer edges to the picture.
Expert Pattern	This is a pattern used for expert adjustment.
Color Filter	Accurately adjusts color and tint by filtering a specific color area of RGB space.
White Peaking	Adjust white color brightness. White peaking can be adjusted from 0 to 10. Adjust to higher setting to achieve brighter picture. Adjust to lower setting for darker picture.
Color Temperature	Adjusts the overall color of the screen to suit your preference. Select Warm , Cool or Medium . In Expert mode, you can customize the options of each mode.
	<p>Gamma: Select 1.9, 2.2, or 2.4.</p> <p>a. Method: 2 points</p> <ul style="list-style-type: none"> - Pattern: Inner, Outer - Contrast Red/Green/Blue, Brightness Red/Green/Blue: Adjustable range -50 - +50. <p>b. Method: 10 points IRE</p> <ul style="list-style-type: none"> - Pattern: Inner, Outer - IRE (Institute of Radio Engineers) is the unit that indicates the size of the video signal and can be set as either 10, 20, 30 - 90, or 100. You can fine-tune for each setting as shown below. - Luminance: If you set up luminance for 100 IRE, a luminance value satisfying each gamma is automatically calculated for each step from 10 IRE to 90 IRE. - Red/Green/Blue: The adjustment range is -50 - +50.
Color Management System	<p>Adjusts Red/Green/Blue/Yellow/Cyan/Magenta colors. Allows an expert to adjust the tint using a test pattern. Six colors (Red/Green/Blue/Cyan/Magenta/Yellow) can be selectively adjusted without affecting other colors.</p> <p>You may not see colors change on a normal picture even after adjustment.</p> <ul style="list-style-type: none"> - Chroma Red/Green/Blue/Yellow/Cyan/Magenta, Tone Red/Green/Blue/Yellow/Cyan, Magenta: The adjustment range is -30 - +30 each.

AUDIO Settings

- 1 Press the **SETTINGS** button.
- 2 Use the \wedge , \vee , \lt , \gt buttons to select **AUDIO** and press the **OK** button.
- 3 Use the \wedge , \vee , \lt or \gt button to set up a desired item and press the **OK** button.
 - To return to the previous menu, press the \curvearrowright button.

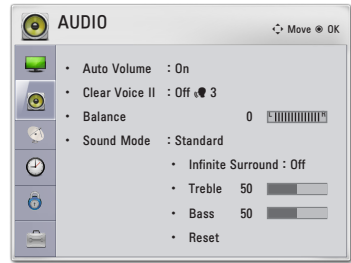

The available audio settings are described as follows.

Setting	Description	
Auto Volume	Automatically adjusts the volume level.	
Clear Voice II	Makes the voice from the projector crisp and clear.	
Balance	Adjusts the balance of the left and right speakers.	
Sound Mode	Adjusts sound.	
	Option	
	Standard	Select when you want standard-quality sound.
	Music	Select when you listen to music.
	Cinema	Select when you watch movies.
	Sport	Select when you watch sports events.
Game	Select when you play games.	
Infinite Surround	LG's unique sound option provides 5.1 channel stereo sound from two speakers.	
Treble	Adjusts the treble sound.	
Bass	Adjusts the base sound.	
Reset	Resets all the sound settings to the factory default.	

CHANNEL Settings

- 1 Press the **SETTINGS** button.
- 2 Use the **^**, **v**, **<** or **>** button to select **CHANNEL** and press the **OK** button.
- 3 Use the **^**, **v**, **<** or **>** button to set up a desired item and press the **OK** button.
 - To return to the previous menu, press the **↶** button.

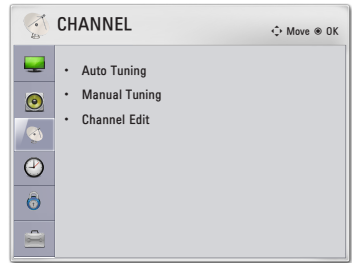

The available channel settings are described in the following.

Setting	Description
Auto Tuning	Tunes and stores all available channels through antennas or cable inputs.
Manual Tuning	Tunes and stores the channels you want manually.
Channel Edit	Adds or deletes channels.

TIME Settings

- 1 Press the **SETTINGS** button.
- 2 Use the \wedge , \vee , $<$ or $>$ button to select **TIME** and press the **OK** button.
- 3 Use the \wedge , \vee , $<$ or $>$ button to set up a desired item and press the **OK** button.
 - To return to the previous menu, press the \curvearrowright button.

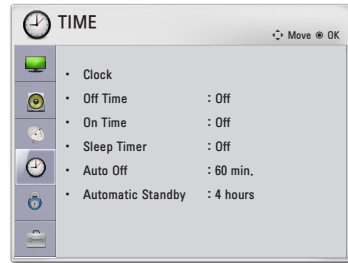

The available time settings are described as follows.

Setting	Description
Clock	Sets the time, date, or Timer feature.
Off Time /On Time	<p>Sets the time to turn on or off the projector automatically. To use this function, you should set the current time and date in advance.</p> <div style="border: 1px solid black; padding: 5px;"> <p>NOTE</p> <ul style="list-style-type: none"> If you set both Off time and On time features to the same time, the Off time feature overrides the On time feature. If you do not press any button within 2 hours after the projector turns on by the On Time feature, the projector enters the Standby mode automatically. </div>
Sleep Timer	Sets the length of time until the projector turns off.
Auto Off	If there is no signal, the projector automatically turns off after the preset time has elapsed.
Automatic Standby	If there is no press any button when Automatic Standby function is on, the Projector automatically switches to the standby mode.

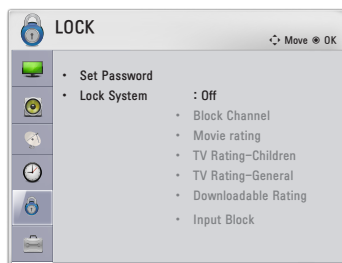

LOCK Settings

- 1 Press **MENU** to access the menu.
- 2 Press the Navigation buttons to scroll to **LOCK** and press **OK**.
- 3 Press the Navigation buttons to scroll to the setting or option you want and press **OK**.
 - To return to the previous menu, press the **↶** button.



The available lock settings are described in the following.

Setting	Description
Set Password	Changes the 4-digit password. The default PIN is "0 0 0 0". If you forget your password, press "0-3-2-5" on the remote control.
Lock System	Activates or deactivates the lock system.
	Option
	Off Locks the selected channel. When you enter the password for a locked channel, the channel is unlocked temporarily.
	On Locks the selected input.
Block Channel	Blocks the channels that contain inappropriate contents for children. The channels can be selected but the screen blank and the audio is muted. To watch a locked channel, enter the password.
Movie rating	Blocks the movies that are only broadcasted on the projector and contain inappropriate contents, based on the Motion Picture Association of America (MPAA) rating.
	Rating
	G General audiences – All ages admitted
	PG Parental guidance suggested – Some material may not be suitable for children
	PG-13 Patents strongly cautioned – Some material may be inappropriate for children under 13
	R Restricted – Under 17 requires accompanying parent or adult guardian
	NC-17 No one 17 and under admitted.
	X Adults only
	Blocking Off Permits all programs

Setting	Description
TV Rating-Children	Blocks the children's TV programs that parents do not want their children to watch. To block other TV programs, you should set the TV Rating-General feature.
	Rating
	Age Applies to TV-Y, TV-Y7
	Fantasy Violence Applies to TV-Y7
TV Rating-General	Blocks the TV programs that you want based on the ratings by using the Parental Control Function (V-Chip).
	<div style="border: 1px solid black; padding: 5px;">  NOTE <ul style="list-style-type: none"> • The V-Chip electronically reads TV program ratings and allows parents to block program that are unsuitable for children. </div>
	Rating
	Age applies to TV-G, TV-PG, TV-14, TV-MA
	Dialogue (sexual dialogue) applies to TV-PG, TV-14
	Language (adult language) applies to TV-PG, TV-14, TV-MA
	Sex (sexual situations) applies to TV-PG, TV-14, TV-MA
	Violence applies to TV-PG, TV-14, TV-MA
Downloadable Rating	This function operates only when projector has received Region5 Rating data. The name of the rating option may differ.
	<div style="border: 1px solid black; padding: 5px;">  NOTE <ul style="list-style-type: none"> • This feature is available only for digital channels. </div>
Input Block	Block the input sources.
Key Lock	This feature can be used to prevent unauthorized viewing by locking out the panel controls, so that it can only be used with the remote control. In Key Lock 'On' , if the projector is turned off, press the Power button. With the Key Lock ' On ', the display ' Key Lock ' appears on the screen if any button on the panel is pressed while viewing the projector.

OPTION Settings

- 1 Press the **SETTINGS** button.
- 2 Use the \wedge , \vee , \lt or \gt button to select **OPTION** and press the **OK** button.
- 3 Use the \wedge , \vee , \lt or \gt button to set up a desired item and press the **OK** button.
 - To return to the previous menu, press the \rightarrow button.

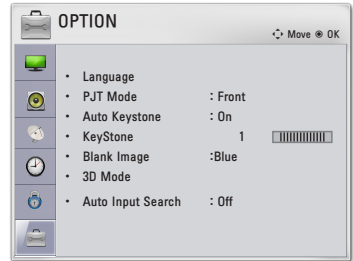

The available option settings are described as follows.

Setting	Description			
Language	Selects a desired Menu Language.			
PJT Mode	<p>This function turns the projected image upside down or flips horizontal.</p> <ul style="list-style-type: none"> • Select Rear when projecting from the back of the transparent screen purchased separately. • Select Ceiling when installing the product on the ceiling. • When PJT Mode is Front/Front Ceiling/Rear/Rear Ceiling, the left/right of the speaker changes automatically. 			
Auto Keystone	Auto Keystone provides a rectangular screen image by automatically adjusting the Keystone number when there is a trapezoidal screen image caused by tilting of the projector.			
	Option			
	<table border="1" style="width: 100%;"> <tr> <td style="width: 20%;">ON</td> <td>Automatically adjusts the Keystone number.</td> </tr> <tr> <td>Off</td> <td>Manually adjusts the Keystone number.</td> </tr> </table>	ON	Automatically adjusts the Keystone number.	Off
ON	Automatically adjusts the Keystone number.			
Off	Manually adjusts the Keystone number.			
Keystone	To prevent the screen image from becoming trapezoidal, Keystone adjusts the top and bottom width of the image if the projector is not set at a right angle to the screen.			
Blank Image	Selects a background for blank Image.			
3D Mode	Selects 3D mode.			
Auto Input Search	Automatically searches and displays an input signal type when it is received.			

Setting	Description	
Auto Power	Makes the projector turn on automatically when the adaptor plug is inserted.	
	Option	
	On	When the DC plug is connected to the projector, it turns on automatically.
Off	When the DC plug is connected to the projector, it goes into standby mode.	
High Altitude	If the projector is used at an altitude higher than 1200 meters, turn this on. Otherwise, the projector may overheat or its protection function may be activated. If this happens, turn the projector off and then on again after waiting for several minutes.	
Caption	Sets whether to display captions and customize your option in each mode.	
	Mode	
	CC 1-4 (Closed Captioning)	Displays the audio portion of a TV program as text on the screen. CC1 is the most common mode in use.
	Text 1-4	<ul style="list-style-type: none"> - Field 1 data channels: two Captions (CC1, CC2) and two Text (T1, T2). - Field 2 data channels: two Captions (CC3, CC4) and two Text (T3, T4).
	Service 1-6	This is only available for the digital broadcasting system.
	Option (For Digital Broadcasting)	
	Size	Selects the wordsize.
	Font	Selects a typeface for the text.
	Text Color	Selects a color for the text.
	Text Opacity	Adjusts the opacity for the text color.
	Bg Color	Adjusts the opacity for the text color.
	Bg Opacity	Adjusts the opacity for the background color.
Edge Type	Selects an edge type.	
Edge Color	Selects a color for the edges.	

Setting	Description	
Standby Light	Adjusts the LED button indicator.	
	Option	
	On	When the buttons are touched, their indicators are all turned on at maximum brightness. In standby mode, all LED indicators are turned on at 20 % of the maximum brightness.
Off	When the buttons are touched, their indicators are all turned on at maximum brightness. In standby mode, all LED indicators are turned off.	
DivX(R) VOD	sets DivX related settings.	
Initial Setting	Resets all the projector settings to the factory default.	

MAKING CONNECTIONS

You can connect various external devices to the ports on the projector.

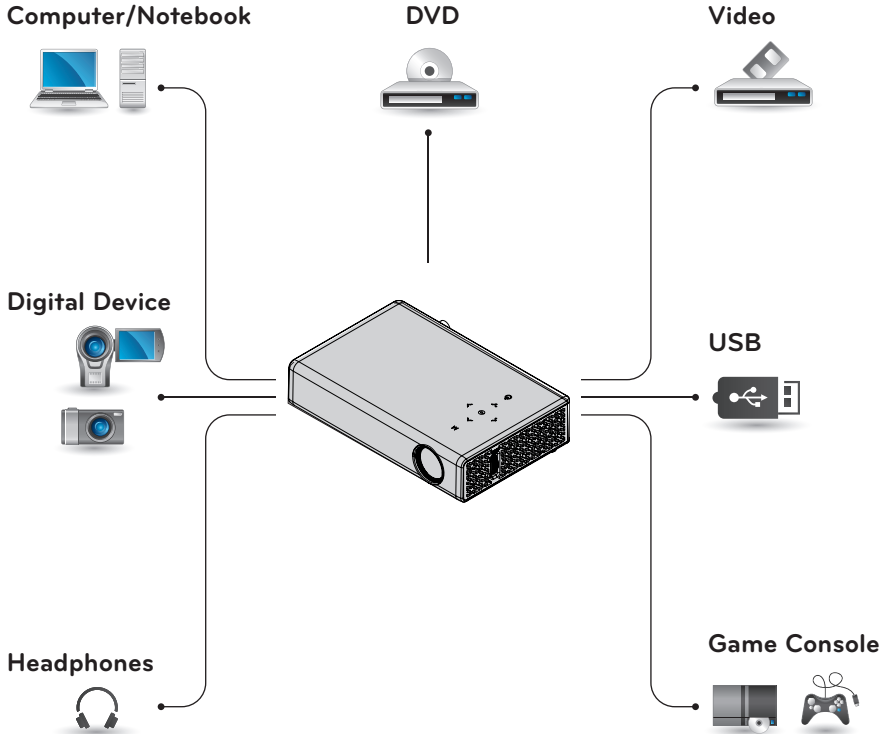

Connecting to an HD Receiver, DVD Player, or VCR

Connect an HD receiver, DVD Player, or VCR to the projector and select an appropriate input mode.

HDMI Connection

With an HDMI cable, you can enjoy high quality picture and sound. Press the **INPUT** button on the remote control to select **HDMI**.

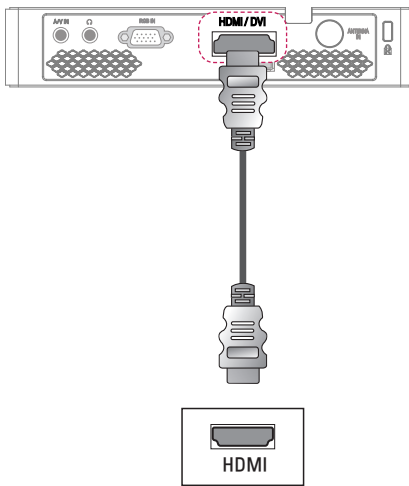

Connecting to a PC

The projector supports Plug & Play. A PC will automatically recognize the projector and requires no driver to be installed.

RGB Connection

Connect the PC output and the PC video input port of the projector with the RGB cable.

For audio signal, connect the PC and the projector with an optional audio cable.

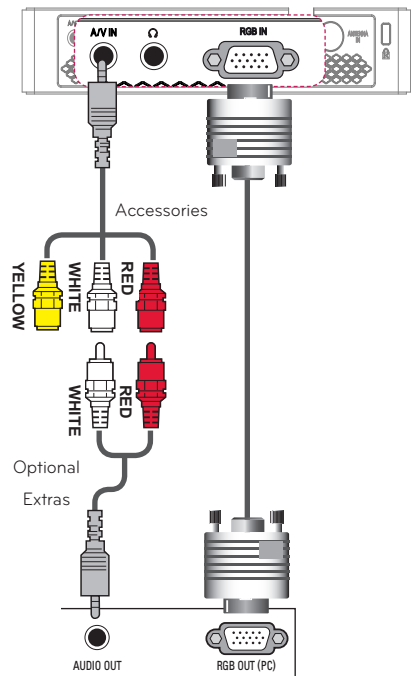

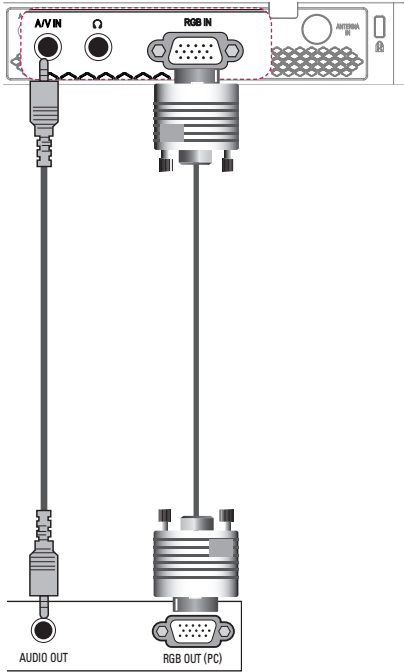

You can connect the audio cable without using a gender as shown in the illustration above.

Connecting to the AV INPUT

Connect the output ports of an external device and the AV INPUT port of the projector. Press the **INPUT** button to select AV.

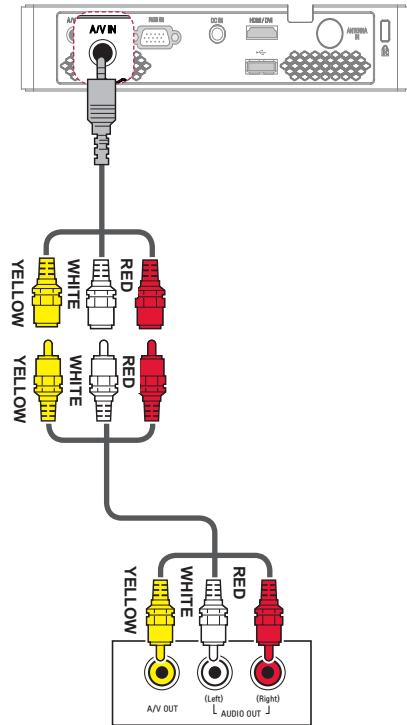

Component Connection

You can enjoy vivid images when you connect an external device with a **RGB IN** port to the component port of the projector. Press the **INPUT** button on the remote control to select **Component**.

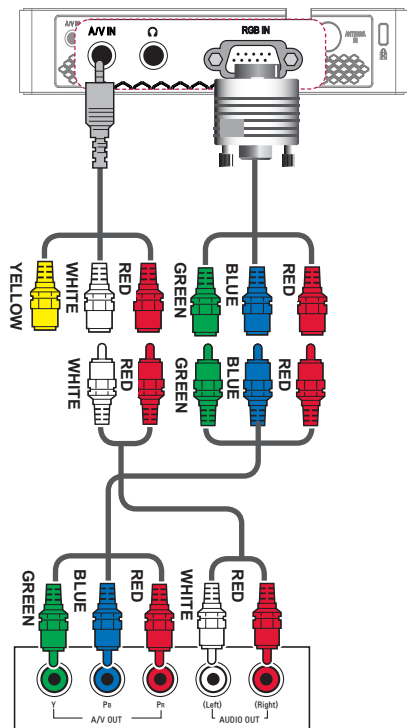

Connecting to Headphones

You can listen to the audio through a headphone.

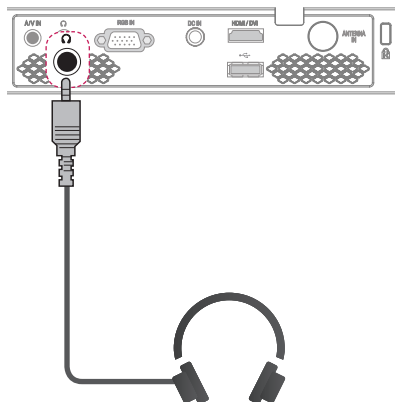

MAINTENANCE

Clean your projector to keep it in optimum condition.

Cleaning the Projector

Cleaning the Lens

If there is any dust or staining on the lens surface, you must clean the lens. Use an air spray or a cleaning cloth to clean the lens.

To remove dust or stains, use an air spray or apply a small amount of cleaning agent onto a swab or soft cloth to lightly rub the lens.

Please be aware that liquid may flow onto the lens if the product is sprayed directly onto the lens.

Cleaning the Projector Case

To clean the projector case, first unplug the power cord.

To remove dust or stains, use only a dry, lint-free, nonabrasive cloth to polish the lens.

Do not use alcohol, benzene, thinners or other chemicals, which may damage the case.

SPECIFICATIONS

MODELS	PB63U (PB63U-JE)	
Resolution (Pixel)	1280 (Horizontal) × 800 (Vertical)	
Aspect ratio	16:10 (Horizontal:Vertical)	
Panel size (mm)	11.623	
Projection distance (Video size)	0.80 m - 3.25 m (63.5 cm - 254.0 cm)	
Ratio of upward projection	100 %	
Working range of the remote control	3 m	
Video input	NTSC M / PAL-B, D, G, H, I / PAL M / PAL N / PAL 60 / SECAM	
AC-DC Adaptor	19.5 V  , 4.62 A (Adaptor Input 100 ~ 240 @ 50 Hz/60 Hz)	
Audio Output	1 W + 1 W	
Television System	DTV-ATSC / TV-NTSC	
Program Coverage	VHF 2 - 13, UHF 14 - 69, CATV 01 - 135, DTV 2 - 69, DTV 1 - 135	
External Antenna Impedance	75 Ω (VHF/ UHF)	
Height (mm)	33.8 (without foot), 38.3 (with foot)	
Width (mm)	158	
Depth (mm)	101.5	
Weight (g)	445	
USB Device	5 V, 0.5 A (Max.)	
Operation environ- ment	Temperature	
	Operation	0 °C - 40 °C
	Storage	-20 °C - 60 °C
	Relative Humidity	
	Operation	0 % - 80 %
Storage	0 % - 85 %	

Supported Monitor Display

Resolution	Horizontal Frequency (kHz)	Vertical Frequency (Hz)
640 x 350	31.468	70.09
720 x 400	31.469	70.08
640 x 480	31.469	59.94
800 x 600	37.879	60.31
1024 x 768	48.363	60.00 119.99
1152 x 864	54.348	60.053
1280 x 800	49.68	60
1360 x 768	47.712	60.015
1280 x 1024	63.981	60.020
1400 x 1050	65.317	59.979
1680 x 1050	65.3	60

- If an invalid signal is input into the projector, it will not be displayed properly on the screen or a message such as "No Signal" or "Invalid Mode" will be displayed.
- The projector supports the DDC1/2B type as the Plug & Play function (Auto-recognition of PC monitor).
- PC synchronization signal types supported: Separate type synchronization.
- In PC mode, 1280 x 800 is recommended for the best picture quality.

HDMI/DVI-DTV/WiDi supported mode

Resolution	Horizontal Frequency (kHz)	Vertical Frequency (Hz)
720 x 480	31.469 31.5	59.94 60
720 x 576	31.25	50
1280 x 720	37.5 44.96 45	50 59.94 60
1920 x 1080	33.72 33.75 28.125 26.97 27 33.716 33.75 56.25 67.43 67.5	59.94 60 50 23.97 24 29.976 30.00 50 59.94 60

Component port connecting information

Signal	Component
480i / 576i	o
480p / 576p	o
720p / 1080i	o
1080p	o (50 Hz / 60 Hz only)

Open Source Software Information

To obtain the source code under the GPL, LGPL, MPL and other open source licenses, which is contained in this product, please visit

<http://opensource.lge.com>.

In addition to the source code, all referred license terms, warranty disclaimers and copyright notices are available for download.

If you send an email to opensource@lge.com to request for the software's open source code installed into the projector within three years of purchase, we will send you a CD-ROM. You will only be charged a minimum for packaging and delivery.



The model and serial number of the projector are located on the back or on the side of the projector. Record them below should you ever need service.

MODEL _____

SERIAL _____