

Canon

Video Display

DP-V2420

DP-V2421

Instruction Manual

- Before use, be sure to read this guide, including the safety and handling precautions.
- Reading this guide will help you learn to use the video display properly.
- Store this guide safely so that you can use it in the future.

English

Table of Content

Introduction	4
About this manual	4
Trademarks	4
Supplied Accessories	4
Important Usage Instructions	5
Safety Instructions and Handling Precautions	6
Features	11
Nomenclature	12
Installation/Connection	15
How to Carry the Main Unit	15
Procedures to attach the protection panel	15
Procedures to attach/detach stands	16
Preventing from Tipping	17
Mounting the Main Unit on a Stand or Wall	18
Connecting the Main Unit to Input Devices	19
Turning on the Power	21
Turning on the Power of the Main Unit	21
Installing the AC power cord clamp HC-01 (Included)	21
Operating the Video Display	22
Operating the jog dial	22
Basic operations to use the OSD menu	22
Adjusting Image Quality While Viewing the Entire Image	24
Temporarily Saving Parameters (Anchor Point Setting)	25
Enlarging the display (Zoom function)	25
Changing Image Quality Automatically According to Input Signal	26
Adjust image quality on left/right side of screen (image comparison mode)	27
Calibration without a PC	27
Export/Import	29
Set Date/Time	31
Inputting Characters	32
Using the Function (F) Buttons	33
Using the Channel (CH) Button	33
Checking Signal Information and Status of the Main Unit	35
Operating the video display using an external device [LAN terminal]	35
Operating the video display using an external device [USB terminal: Wi-Fi connection]	36
Use a web browser to remotely operate the video display	38

OSD Menu	41
OSD Menu Index.....	41
Adjustment.....	49
Channel Settings.....	64
Display Settings.....	71
Audio Settings.....	75
Marker Settings.....	76
Function Settings.....	81
Picture Function Settings.....	94
Network/IMD Settings.....	99
System Settings.....	101
Signal Information.....	108
System Information.....	108
Main specifications/Performance	109
Dimensions.....	111
Appendix	112
Supported Signal Format.....	112
Image/Frame Display.....	127
Error Messages	130
Troubleshooting	133
Software Used in This Product	135
Index	140

Introduction





Thank you for purchasing the Video Display DP-V2420 / DP-V2421.

The On Screen Display (thereafter referred to OSD) default language setting is English. To change the OSD menu language setting, please refer to p. 101.

About this manual

The illustrations used in this document are for the DP-V2420. Some of the illustrations used in the manual have been simplified for clarity.

Conventions used in this manual

- : Indicates a reference page.
-  Note: Indicates a note.
-  Reference: Indicates reference information.
-  CAUTION: Indicates an item you must observe.

Trademarks

- HDMI, HDMI logo, and High-Definition Multimedia Interface are trademarks or registered trademarks of HDMI Licensing Administrator, Inc. in the U.S. and other countries.
- VESA is a registered trademark or trademark of Video Electronics Standards Association in the U.S. and other countries.
- Wi-Fi, WPA, and WPA2 are registered trademarks of the Wi-Fi Alliance.
- Apple and Safari are trademarks of Apple Inc. registered in the United States and other countries.
- Google and Google Chrome are trademarks or registered trademarks of Google LLC.
- Other product and company names herein are trademarks or registered trademarks of their respective owners.

Supplied Accessories

The following items are supplied with this product. Please check before using.

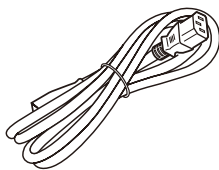

AC Power Cord HT-21

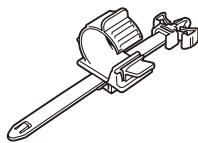

AC Power Cord clamp
HC-01

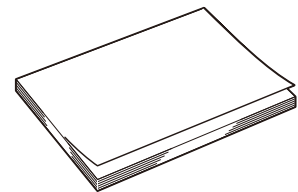

Instruction Manual
(this document)

Important Usage Instructions

For the customers in the U.S.A.

This equipment has been tested and found to comply with the limits for a Class A digital device, pursuant to Part 15 of the FCC Rules.

These limits are designed to provide reasonable protection against harmful interference when the equipment is operated in a commercial environment. This equipment generates, uses, and can radiate radio frequency energy and, if not installed and used in accordance with the instruction manual, may cause harmful interference to radio communications. Operation of this equipment in a residential area is likely to cause harmful interference in which case the user will be required to correct the interference at his own expense.

Do not make any changes or modifications to the equipment unless otherwise specified in the manual. If such changes or modifications should be made, you could be required to stop operation of the equipment.

Use of shielded cable is required to comply with class A limits in Subpart B of Part 15 of FCC Rules.

This device complies with Part 15 of the FCC Rules. Operation is subject to the following two conditions: (1) This device may not cause harmful interference, and (2) this device must accept any interference received, including interference that may cause undesired operation.

Canon U.S.A Inc.
One Canon Park, Melville, NY 11747, U.S.A.
Tel No. (631)330-5000

For the customers in Canada

CAN ICES-3 (A) / NMB-3 (A)

For the customers in Europe

Warning;

This is a class A product. In a domestic environment this product may cause radio interference in which case the user may be required to take adequate measures.

CANON INC.
30-2, Shimomaruko 3-chome, Ohta-ku, Tokyo 146-8501, Japan

CANON EUROPA N.V.
Bovenkerkerweg 59, 1185 XB Amstelveen, The Netherlands



Only for European Union and EEA (Norway, Iceland and Liechtenstein)

This symbol indicates that this product is not to be disposed of with your household waste, according to the WEEE Directive (2012/19/EU) and national legislation. This product should be handed over to a designated collection point, e.g., on an authorized one-for-one basis when you buy a new similar product or to an authorized collection site for recycling waste electrical and electronic equipment (EEE). Improper handling of this type of waste could have a possible negative impact on the environment and human health due to potentially hazardous substances that are generally associated with EEE. At the same time, your cooperation in the correct disposal of this product will contribute to the effective usage of natural resources. For more information about where you can drop off your waste equipment for recycling, please contact your local city office, waste authority, approved WEEE scheme or your household waste disposal service. For more information regarding return and recycling of WEEE products, please visit

www.canon-europe.com/weee.

Safety Instructions and Handling Precautions

Be sure to read these instructions in order to operate the product safely.
Follow these instructions to prevent injury or harm to the operator of the product or others.

WARNING

Denotes the risk of serious injury or death.

- **Do not disassemble or modify the video display.**
Inside, the video display contains high-voltage/extremely hot/movable parts that can cause fire, electric shock, burns or injury.
- **Do not insert foreign objects or liquids into the video display.**
If metallic objects, flammable objects or liquids get inside the video display, this may cause fire, electric shock or malfunction.
- **Be sure to use the correct voltage.**
Using a power source with a voltage other than that specified in this instruction manual can cause fire or electric shock. Always use the supplied (or specified) AC power cord. For your safety, do not use this AC power cord to power other equipment.
- **Do not use the video display in the following places.**
Doing so can cause fire, electric shock or malfunction.
 - Next to a window when it is raining or snowing.
 - Places subject to high humidity and dusty places.
 - Places exposed to water drops or moisture such as bathrooms or watering places.
 - Places directly exposed to soot, smoke or steam, or nearby heaters and humidifiers.
 - Places where flammable gases may be present.
 - Places exposed to direct sunlight.
- **Do not install or store the video display in places exposed to direct sunlight.**
The video display's internal temperature can rise and cause fire or malfunction.
- **Do not damage the power cord.**
Do not place heavy objects on the power cord and do not pull, modify, heat or tie the power cord in a bundle. The power cord may be damaged (exposed or broken wires, etc.) and cause fire or electric shock.
- **When using three-pronged plugs with a ground connection:**
Always connect the ground prong.
A short circuit occurring when the ground prong is not connected can cause fire or electric shock.
The video display's power cable features a three-pronged plug.
- **Do not touch the power cable or plug during lightning storms.**
This can cause electric shock.
- **Do not touch the power cable or plug with wet hands.**
This can cause electric shock.

- **Observe the following precautions regarding the power source and power plug.**

Failing to do so can cause fire or electric shock.

- Insert the power plug fully and securely into the power outlet. Do not use a damaged power cable or plug or a loose power outlet.
- Hold the plug itself when unplugging the power cable. Pulling the power cord can damage the power cord and cause fire or electric shock.
- Periodically remove any dust buildup from the power plug.
- Do not obstruct the access to the power plug by placing other objects around it.
- Do not connect many power cords to the same power outlet.
- When using an extension cable, make sure the total power consumption of the devices you connect to the extension cable does not exceed its rated power.

- **If the video display was dropped or exposed to a strong impact, turn it off immediately and unplug the power plug from the power outlet.**

The video display is a precision instrument and continued use in such case can result in a short circuit and cause fire or electric shock.

- **Before starting any maintenance work, turn off the video display and unplug the power plug from the power outlet.**

Failing to do so can cause electric shock.

- **Before moving, installing, removing or connecting the video display to peripheral devices, turn off the video display and all connected devices and unplug their power plugs from the power outlet.**

Failing to do so can cause fire, electric shock or malfunction.

- **In any case of unusual circumstances such as the presence of smoke or strange sounds or smell, turn off immediately the video display and unplug the power plug from the power outlet.**

Continued use can cause fire or electric shock.

- **Do not obstruct the access to the power plug so it can always be easily unplugged.**

Failing to disconnect the power plug immediately after unusual circumstances have occurred can cause fire or electric shock.

- **Do not block the ventilation holes.**

Blocking the video display's vent holes can result in the internal temperature rising and cause fire or malfunction. Observe the following precautions to ensure proper ventilation.

- Do not push the video display into narrow confined spaces or enclosures.
- Do not wrap the video display in cloth or other materials.
- Do not place the video display facing up, lay it sideways or upside-down.

- **For your safety, unplug the power plug from the power outlet when not using the video display for extended periods of time.**

Dust buildup on the power plug can cause fire.

- **If the screen is damaged, do not touch the leaking liquid crystal or other internal liquids.**

If the LCD panel is damaged and liquid crystal or other internal liquids leak out, do not put the liquids in the mouth, inhale or swallow it or let it come in contact with the skin. If the liquids get in the eye or mouth, wash it immediately with plenty of water. If the liquids come in contact with the skin or clothes, wipe them immediately with alcohol etc. and wash the exposed area with soap. Leaving the liquids untreated can cause injury or damage.

- **Keep all packaging material out of the reach of children.**

Packaging material tightly wrapped around someone's head can result in strangulation or suffocation.

CAUTION

Denotes the risk of injury.

- **Do not place any objects on the video display and do not climb on it.**
The video display can tip or fall and cause injury.
- **Do not install the video display on an unstable surface.**
Installing the video display on a wobbly or slanted surface can cause the display to tip or fall and cause injury. Thoroughly check also the strength and sturdiness of the surface where the video display will be placed or installed.
- **Take precautions to prevent the video display from tipping or falling.**
In an earthquake the video display can tip or fall. For your safety, when installing the video display on a TV stand or other furniture, take precautionary measures to secure the video display against tipping or falling (📖 17). Taking such measures can be effective in reducing the risk of injury or damage but the effectiveness of the prevention measures cannot be guaranteed in all earthquakes.
- **Always follow the specified procedure to install the video display (📖 15).**
If the installation is not performed correctly, the video display may tilt or fall and cause injury.
- **Inspect the condition of the installation about once per year.**
An inadequate fitting or mounting can cause the video display to fall and cause injury.
- **When using headphones, set the volume at a safe level.**
Listening through headphones at a high volume can harm your hearing.
- **Do not look at the screen for long periods of time.**
Doing so can cause conditions such as eye strain or decreased vision. When looking at the screen for long periods of time, rest periodically. If you feel discomfort after continued usage, stop using the video display immediately and rest. If you continue to feel discomfort, consult a physician.

When Using the Main Unit

- The screen may be damaged if it is left facing strong source of light. Please take precautions when placing it near a window.
- Do not press firmly on the screen, scratch it or place an object on the screen. It can cause non-uniformity or damage to the panel.
- The screen and cabinet may become warm during use. Note this does not constitute a malfunction.
- Depending on the environment where the video display is used, the internal temperature of the display may rise, resulting in becoming hot to touch. Please take care when handling the video display.
- Viewing the display for prolonged periods of time may lead to eye strain or decreased vision. Please ensure to take rest periodically to avoid these symptoms.
- Refer to Recommendation ITU-R BT.1702 "Guidance for the reduction of photosensitive epileptic seizures caused by television" and related guidelines.

About Backlight

The backlight has a limited service life so its brightness may degrade and color may change due to aging.

About Temporary Screen burn-in

If a stationary image is displayed for a prolonged period, screen burn-in may occur where you see remnants of what was displayed. This is a characteristic of LCD and is not a failure. However, this is only temporary and will disappear when playing video.

About the LCD screen

The screen is produced using extremely high-precision manufacturing techniques, with more than 99.99% of the pixels operating to specification. Less than 0.01% of the pixels may occasionally misfire or appear as black, red, blue or green dots. In addition, this tendency may increase through long term use due to characteristic of the LCD panel. These do not constitute a malfunction.

Condensation

If this equipment is brought into a warm room while it is cold or if the room is heated suddenly, condensation may form on the surface or inside the equipment. Note that the equipment may be damaged if it is used under such condition. If condensation has formed on the surface or inside the equipment, do not use the video display as it may get damaged. Turn the power off and wait until the condensation has evaporated before using the video display.

Cleaning

- Before cleaning, be sure to unplug the power plug from the wall outlet.
- The screen has a special surface treatment, avoid touching it directly with your hand. In addition, never affix adhesive objects such as seals.
- Never use alcohol or benzene, thinner, acidic cleaning solution, alkaline cleaning solution, abrasive or chemical wipes because these will damage the screen.
- If the screen is dirty, wipe gently with soft dry cloth such as cleaning cloth or eye glasses cleaning cloth. Wiping the screen too hard may cause unevenness on the screen or damage the LCD panel. The screen may be scratched if wiped too hard with a cleaning cloth with foreign particles attached.
- When the screen is extremely dirty, wipe with soft cloth such as cleaning cloth or eye glasses cleaning cloth moistened with water-diluted neutral detergent.
- Use a blower to remove dust from the surface of the screen.
- Wipe dirt on cabinet with a soft cloth. If the screen is very dirty, use a moistened cloth with water or mild detergent diluted with water. Do not use alcohol, benzene, paint thinner, or pesticides as they may damage the surface finish or erase characters on the cabinet.

Disposing

- Do not dispose together with normal waste. Do not include the video display in waste that will be taken to landfill.
- Observe the rules and regulations of your local authorities when disposing.

Features

Video Display DP-V2420 / DP-V2421 is an HDR reference display capable of supporting various work flows from shooting through to editing in video production for both digital cinema and broadcasting.

Image quality and functions

- **V2421** Supports 12G/6G-SDI.
- Equipped with a panel with 4096x2160 resolution and backlight system.
- High luminance and high contrast matched to HDR content is achieved.
- Equipped with the HDR display function. (SMPTE ST 2084 and Hybrid Log-Gamma are supported)
- High uniformity is provided by minimizing any variation due to temperature changes and aging.
- Supports wide DCI-P3 color gamut.
- Displays ITU-R BT.2020 color gamut at the optimum level and supports "Constant Luminance".
- Supports ACESproxy.
- Equipped with functions to assist shooting and video checking, including Wave Form Monitor, Vector Scope, Screen Capture, Zoom, and False Color.
- Supports gamma equivalent to CRT standardized by ITU-R BT.1886.
- A color grading controller (Element-Tk made by Tangent Wave Ltd), external sensor, USB memory, or wireless LAN terminal (Wi-Fi adapter) can be connected to the USB port.
- Display Controller CL-01 (included with DP-V3010), external control devices, Canon displays, etc can be connected to the LAN terminal
- Supports "Square Division" and "2 Sample Interleave" video signal transport methods.
- Includes a multi-display function (4 or 2 screens)
- HDR and SDR content can be displayed for comparison.
- Equipped with a HDMI input terminal.

Link with digital cinema cameras

- Supports 4K RAW. Establishes 4K RAW workflow on ACES2065-1.
- CINEMA EOS SYSTEM link
- ARRI / Panasonic Camera System link

Rigidity and flexible installation

- High durability achieved by a metal outer covering.
- The side carrying handle on the main unit is convenient for installation and transporting. The handle and adjustable two position stand provides flexible installation and high portability.

Nomenclature

■ Front face of the main unit

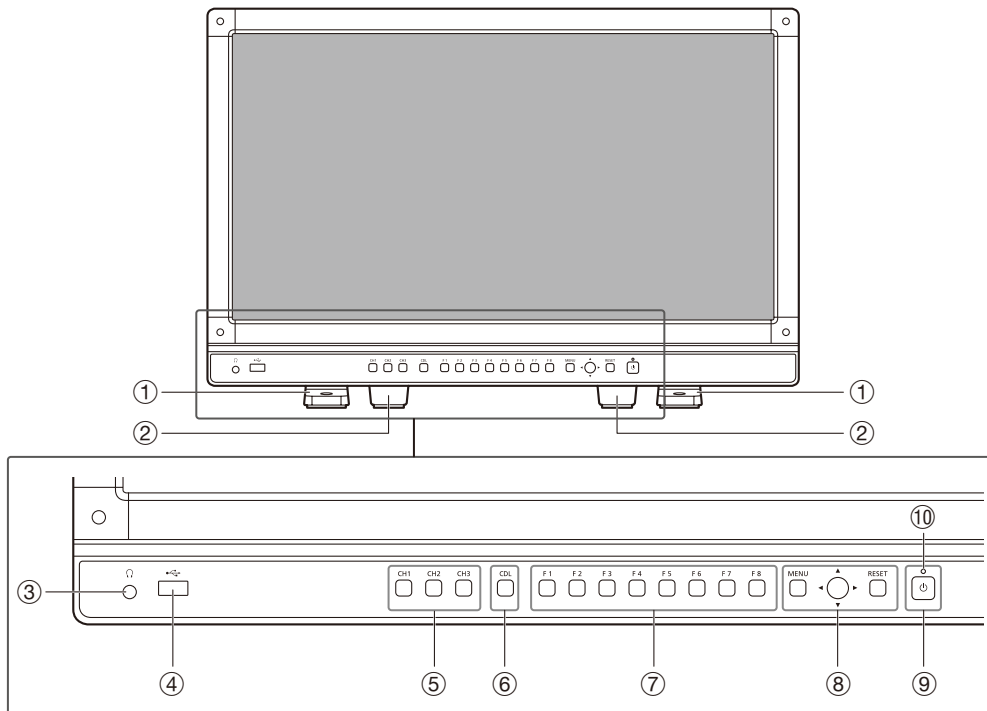

①	Front stand	There are two mounting positions.	16
②	Rear stand	This can be detached.	16
③	Headphone terminal	Connection for headphone set.	75
④	USB port	Connection for an external sensor for calibration (27), USB memory, HUB, color grading controller (Element-Tk made by Tangent Wave Ltd), or wireless LAN adapter (Wi-Fi adapter, 36).	–
⑤	CH1 to 3 buttons	Changes channel.	33
⑥	CDL button	Switches between normal and CDL mode.	–
⑦	F1 to F8 buttons	Execute the defined function. You can assign different functions on F buttons in the normal and CDL modes respectively.	33
⑧	MENU button	Opens/closes the OSD menu, or moves up one level in a menu.	22
	Jog dial	Moves the selection frame within the OSD menu, changes the settings (up/down, left/right, rotation) and determines (press) the selection.	22
	RESET button	Resets the items to be adjusted using the slider and entered characters.	22
⑨	(Power) button	Turns power On/Off.	21
⑩	Power indicator	Displays the status of the main unit. The brightness of the power indicator can be set from "Off" or "1 (dark) to 5 (brightest)" (103). Even when the power indicator is "Off", it will flash during firmware update, or when an error is detected. Off: when power supply is not connected Green lit: when a power supply is connected and the power of the video display is on Green flash: during calibration or firmware update Amber lit: during standby (a power supply is connected and the power of the video display is off) Amber flash: when error is detected	–

■ Back face of the main unit

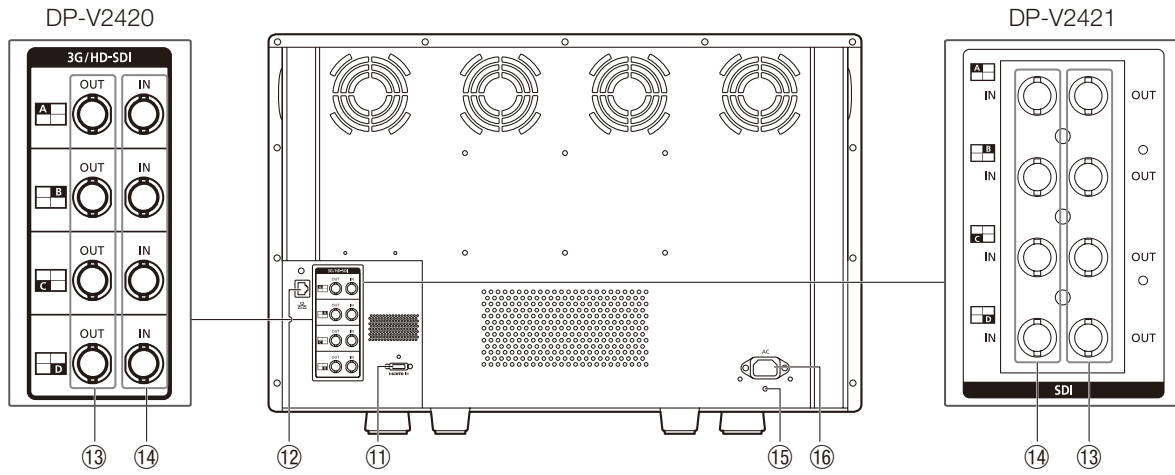

⑪	HDMI input terminal	Used to input HDMI signals.	20
⑫	LAN (10/100 BASE) terminal	Connection for Display Controller CL-01 (included with DP-V3010), external control devices, Canon displays, etc.	—
⑬	SDI output terminal	Pass through output corresponding to 3G/HD-SDI input terminal.	—
⑭	SDI input terminal	Used to input SDI signals.	19
⑮	Cord clamp mounting hole	For installing the AC power cord clamp (Included)	21
⑯	AC power input terminal	Connection for the provided AC power supply cord.	21

■ Side face of the main unit

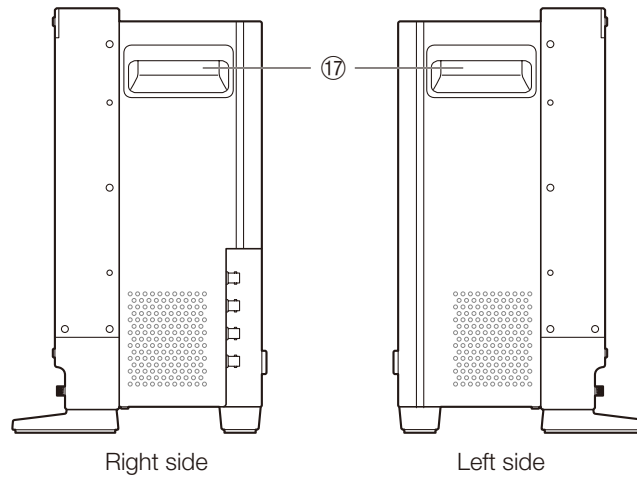

⑰	Carrying handle	Used to install, connect, or carry the unit.	15
---	-----------------	--	----

CAUTION

- When connecting an external sensor for calibration to the USB port, the USB cable length must not exceed 3 m (9.8 ft.). Otherwise, communication error may occur and correct calibration may not be possible.
- The video display can perform measurement or calibration of the display using the DP-V Color Adjustment software. Refer to the Canon website for the DP-V Color Adjustment.
- **V2421** When the video display performs measurement or calibration of the display using the DP-V Color Adjustment or it is being used via LAN, "DP-V2420" will be displayed as the display name.
- Do not use the HUB when connecting a wireless LAN adapter (Wi-Fi adapter) to a USB terminal. The video display may not work.
- For safety, do not connect any connector that may have excessive voltage to the terminal of the video display when connecting peripheral devices.
- Pass through SD-SDI signals are not output correctly.

Note

- Both FAT16 and FAT32 USB memory devices are supported.
- Proper operation cannot be guaranteed for all USB memories.
- It may take 10 seconds or more for the USB memory to be recognized. If the function to save data on a USB memory is executed during recognition, the message "Detecting USB memory" is displayed.

Installation/Connection

How to Carry the Main Unit

When lifting the video display, please use the carrying handles on the display's sides.

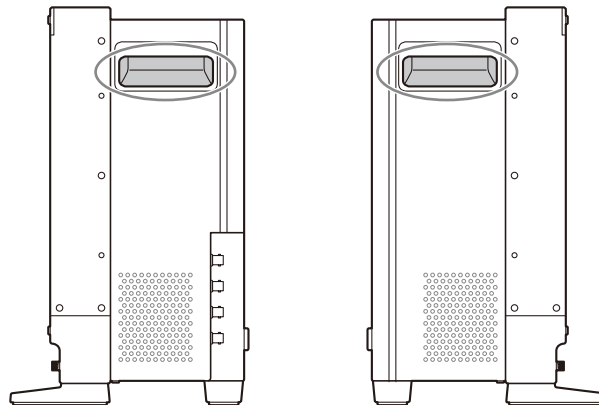

CAUTION

- When unpacking, carrying, installing, or connecting the main unit, please note that at least two people are required.
- When carrying the video display, handle it carefully not to touch or damage the screen.

Procedures to attach the protection panel

You can attach the protection panel to protect the screen when carrying the video display or when using it outdoors.

1. Unscrew the four screws on the front face.

Use a 1.5 mm hexagonal key.

Do not lose the removed screws. Do not use these screws for other purposes.

2. Place the protection panel by aligning its corners with the screw holes.

Take care when attaching the panel in order to avoid damaging it.

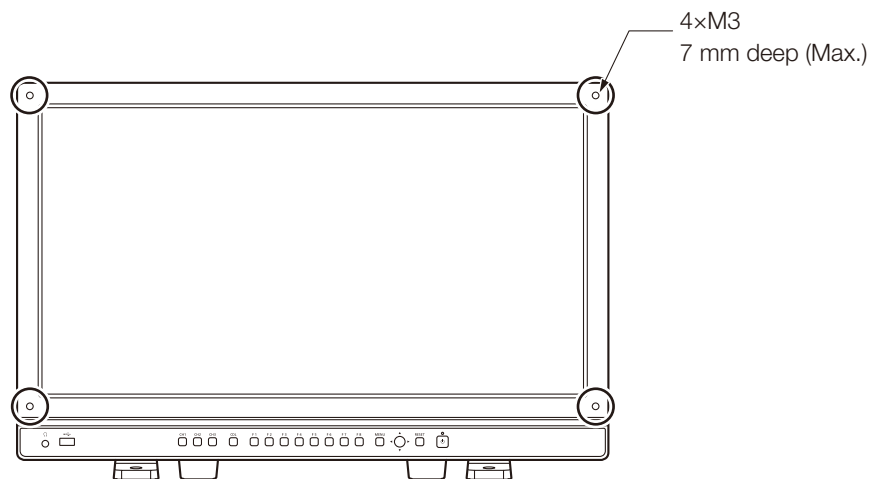

CAUTION

- Avoid touching the screen during this step as it may damage it.

Procedures to attach/detach stands

The main unit comes with two stands which can be detached. The position where the front stand is attached can be changed.

⚠ CAUTION

- Use a flat, clear surface when attaching/detaching the stands.
- The display can tip over if the stand has not been attached.
- Avoid touching the screen during this step as it may damage it.

■ Detaching

1. Place the display with the screen facing down on a soft cloth or cushioning material that is larger than the display.
2. **Front stand: Remove the mounting screws (two each) from the left and right stands.**
Rear stand: Remove the mounting screws (one each) from the left and right stands.
Do not lose the removed screws. Do not use these screws for other purposes.

■ Attaching

1. Place the display with the screen facing down on a soft cloth or cushioning material that is larger than the display.
2. **Align the position of the stand and screw hole on the video display.**
Align the convex part of the stand and concave part of the video display.
3. **Front stand: Fix the left and right stands using the mounting screws (two each).**
Rear stand: Fix the left and right stands using the mounting screws (one each).

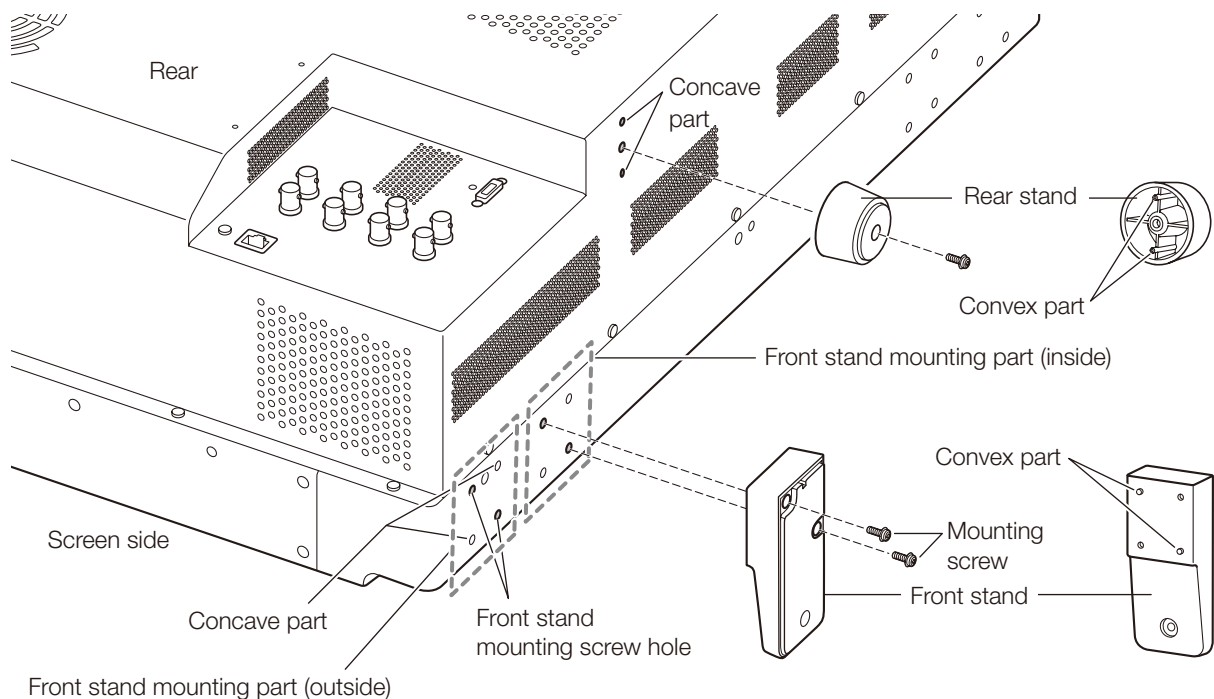

📝 Note

- It is recommended to mount both front stands in either the outside or inside positions.

Preventing from Tipping

Fixing the video display using screw holes on the stands can reduce the risk of the main unit tipping over or falling.

1. Use screws that fit the screw holes.

The screw hole size is shown below.

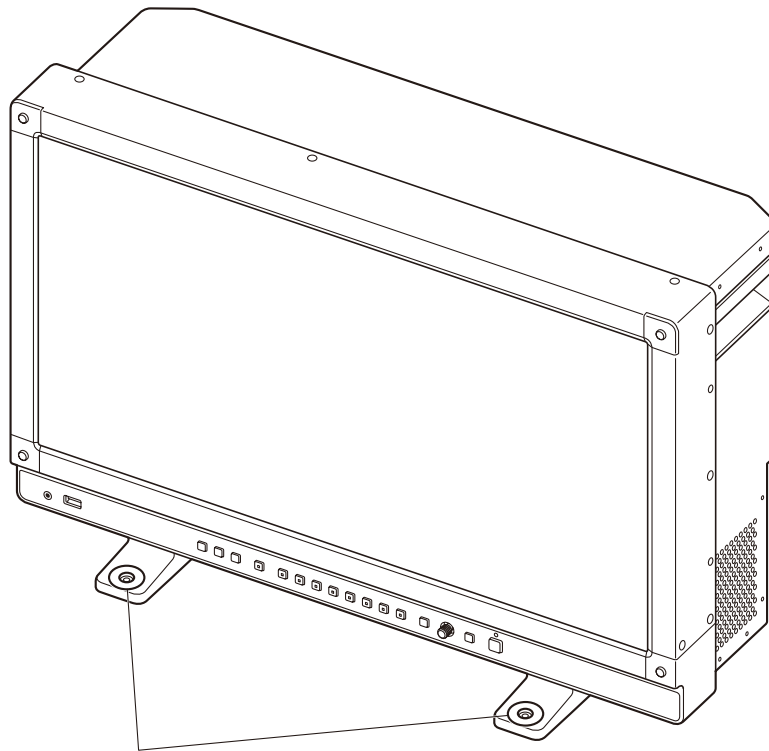

Screw hole
2-φ4.5

CAUTION

- When securing the main unit to a table or desk, please ensure a table or desk is strong enough to carry the weight of the main unit.
- It is recommended to obtain assistance from another person when performing this step.
- Avoid touching the screen during this step as it may damage it.

Mounting the Main Unit on a Stand or Wall

This main unit can be fitted to a stand* or to a wall mount bracket*. Remove the stands beforehand (📖16).

* Commercially available.

⚠ CAUTION

- For safety, make sure to perform this step with at least two people.
- When mounting the main unit on a wall, make sure the wall has sufficient strength. If necessary, apply reinforcement. Also, make sure to check the load capacity of the stand or wall mount bracket.
- When the video display is placed on a rack or display stand and ventilation around it is blocked by equipment placed above or below or in a surrounding area, the operating temperature may increase, causing a failure or overheating. In order to maintain the operating temperature condition of the video display (0 °C to 40 °C), make a space of at least 1U (4.4 cm) above and below and at least 4 cm (1.6 in.) space from its back. Make a sufficient space from peripheral equipment, secure vents, or install a ventilation fan.
- When installing the video display on a wall, make sufficient space from the wall so that cables are not squeezed or twisted.
- Avoid touching the screen during this step as it may damage it.
- Make sure that the main unit does not fall during installation/removal.

1. Attach a commercially available stand or wall mount bracket using the screw holes on the back or side face of the main unit (📖111).

The screw hole size is shown below.

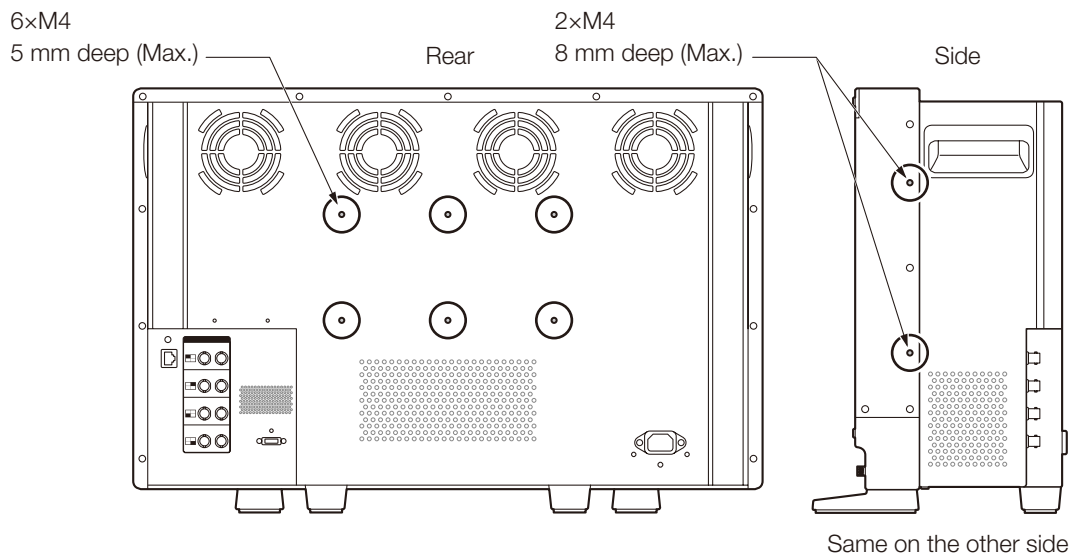

Connecting the Main Unit to Input Devices

The video display has SDI and HDMI input terminals to connect input devices.

CAUTION

- Check that the power of the video display and input devices is switched off before connecting.

SDI input signals

Refer to the SDI input terminals diagram when connecting to the desired input signal. (A, B, C, D)

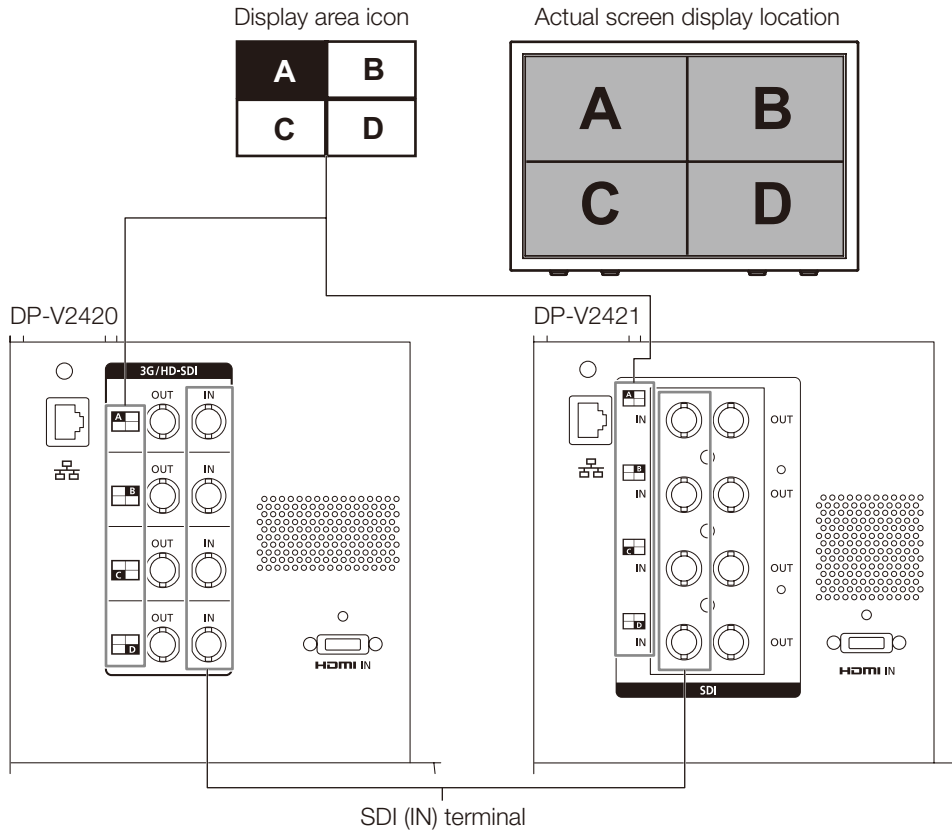

	Input signal		Input terminal	
Quad Link (Square Division)	V2420 3G/HD-SDI V2421 12G/6G/3G/HD-SDI	Top left, Mapping signal	Input A	Single input system
		Top right, Mapping signal	Input B	
		Bottom left, Mapping signal	Input C	
		Bottom right, Mapping signal	Input D	
Quad Link* (2 Sample Interleave)	3G-SDI	Link 1	Input A	Two input systems
		Link 2	Input B	
		Link 3	Input C	
		Link 4	Input D	
Dual Link*	V2420 3G-SDI V2421 6G/3G-SDI	Link 1	Input A	Four input systems
		Link 2	Input B	
	Link 1	Input C		
	Link 2	Input D		
Single Link	V2420 3G/HD/SD-SDI V2421 12G/6G/3G/HD/SD-SDI	—	Input A/Input B/ Input C/Input D	

* The signals are automatically switched when "Link Order" is set to "Automatic".

i Reference

- **V2420** The connection is tested using 4VS03A-5C BNC cables (multi) manufactured by Canare Electric Co.
- **V2421** The connection is tested using D5.5UHDC03E BNC cables manufactured by Canare Electric Co.
- When 3G-SDI RAW signal frequency exceeds 30.00P, it becomes a dual connection.
- Each input terminal is compatible with through output. When signals are input from Input A, connect the cable to the SDI (OUT) terminal of Input A.

■ HDMI input signal

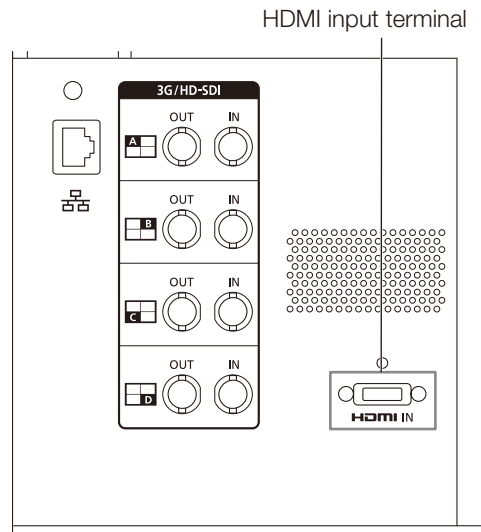

CAUTION

- Use a HDMI cable with the High Speed logo that complies with the HDMI standard. When a non-compliant HDMI standard cable is used, the video display may not work normally, for example a video becomes choppy or nothing is displayed.

Turning on the Power

This section describes how to turn on the power of the main unit.

Turning on the Power of the Main Unit

1. **Plug the provided AC power cord HT-21 to the AC power supply input terminal at the rear.**
The video display goes into standby and the power indicator lights up in amber.
2. **Press the power supply button  at the front.**
The power indicator lights green.

Note

- Warming-up is necessary to stabilize the brightness of the video display. Wait at least 10 minutes after turning on the power before using.

Installing the AC power cord clamp HC-01 (Included)

Install the AC power cord clamp before connecting the AC power cord to the main unit.

1. **Insert the AC power cord clamp connector into the cord clamp mounting hole (①).**
2. **Connect the AC power cord to the main unit (②).**
3. **Secure the AC power cord in place with the holder (③).**
4. **Press the holder against the main unit (④).**
Make sure that there is no slack (**A**).

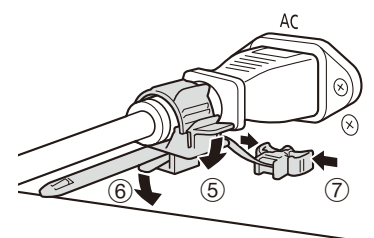
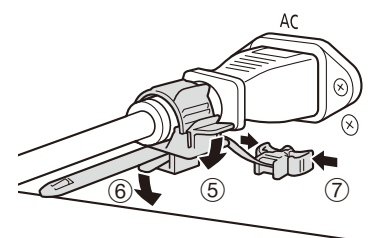
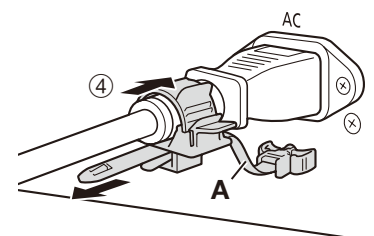
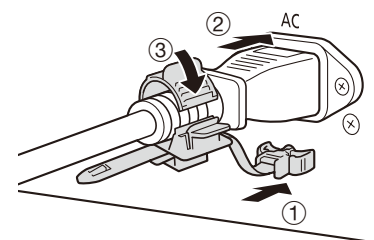

- To remove the AC power cord clamp from the AC power cord: Pull the holder lever (⑤).
- To adjust the length: Push the holder lock lever down (⑥).
- To remove the AC power cord clamp from the main unit: Press the knobs on the left and right and pull out the clamp (⑦).

Operating the Video Display

Using buttons and jog dial on the video display, you can adjust image quality and configure settings for input signals. In addition, you can assign the frequently used functions to the CH and F buttons.

Operating the jog dial

The procedures to operate the jog dial are described below.

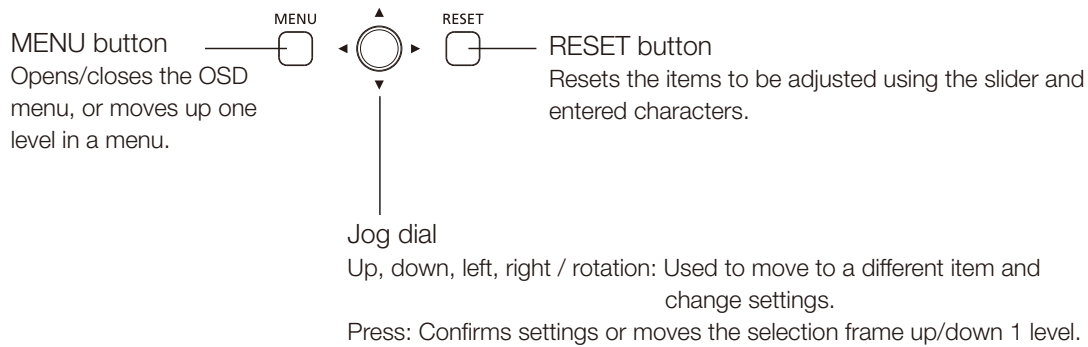

Basic operations to use the OSD menu

This section describes basic operations to use the OSD menu.

1. Press the MENU button to open the OSD menu.

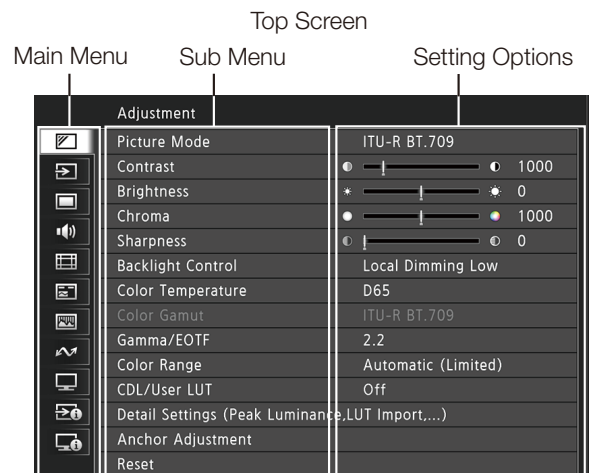

2. Select an item using the jog dial and press it to determine the selection.

The selection frame moves to sub menu.

3. Select an item using the jog dial and press it to determine the selection.

The selection frame moves to setting options.

4. Select the setting using the jog dial.

Settings change according to the operation of the jog dial.

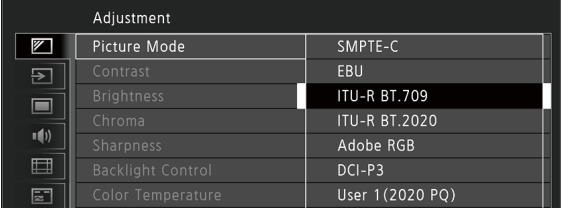

Adjustment	
Picture Mode	SMPTE-C
Contrast	EBU
Brightness	ITU-R BT.709
Chroma	ITU-R BT.2020
Sharpness	Adobe RGB
Backlight Control	DCI-P3
Color Temperature	User 1 (2020 PQ)

5. Press the jog dial to determine the selection.

The selection frame returns to sub menu.

6. Exit menu.

When you press the MENU button, the selection frame moves up one menu level. Move the selection frame all the way to the main menu on the top screen and then press the MENU button to exit the menu.

 **Note**

- The following functions can be returned to their factory default settings or their anchor point ( 25) by pressing the RESET button, after adjusting the image quality.
 - "Contrast", "Brightness", "Chroma", "Sharpness", "Power", "Saturation", "Offset", "Slope"In "User 1-7" mode where you are performing calibration, the setting returns to the value after calibration instead of the factory default.
- To adjust image quality, warming-up is necessary to stabilize the brightness of the video display. Wait at least 10 minutes after turning on the power before using.
- The OSD menu and slider will disappear automatically if no operation is performed for approximately 1 minute. The F button will disappear automatically if no operation is performed for approximately 10 seconds.
- The settings that cannot be set, are grayed out.

Adjusting Image Quality While Viewing the Entire Image

You can adjust the OSD menu to display as a slider at the bottom of the screen. This allows for the image quality to be adjusted whilst it is displayed on the screen.

1. **Press the jog dial when the selection frame is on setting options.**
A slider appears at the bottom of the screen.
2. **Make adjustments using the jog dial with using the slider as guide.**
3. **When adjustments are completed, press the jog dial.**
The screen returns to the original OSD menu.



■ Adjusting "Gain R/G/B, Bias R/G/B" under "Color Temperature"

You can adjust RGB all at once or individually when the slider for adjusting "Gain R/G/B" and "Bias R/G/B" are displayed.

1. **Switch the guide in the upper right area of the slider screen using the jog dial (▲▼).**
The indication changes to "RGB", "R", "G", and "B".
2. **When adjustments are completed, press the jog dial.**
The screen returns to the original OSD menu.

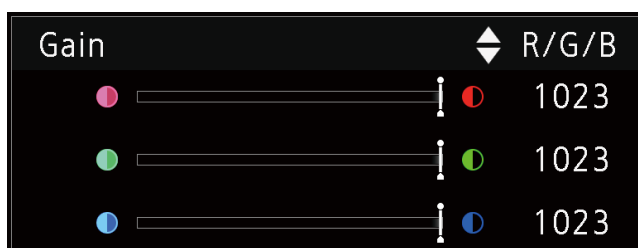

■ Adjusting "x, y" under "Color Temperature"

You can adjust "x, y" in "Color Temperature" on the color map.

1. **Adjust "x" with the ◀▶ and "y" with ▲▼.**
The adjusted value is indicated by the "○" mark on the color map.
2. **When adjustments are completed, press the jog dial.**
The screen returns to the original OSD menu.

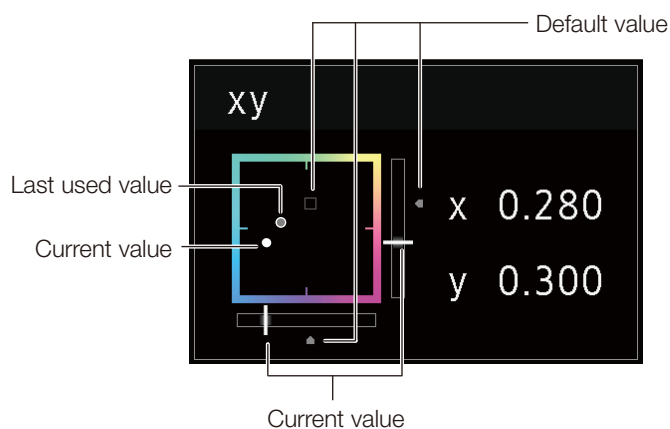

Temporarily Saving Parameters (Anchor Point Setting)

You can temporarily save parameters for "Contrast", "Brightness", "Chroma", "Sharpness", and "HDR Range" and recover the values. See  56 for setting anchor points during CDL adjustment.

1. Press the MENU button to open the OSD menu.
2. Select "Adjustment" using the jog dial and press the dial to determine the selection.
The selection frame moves to sub menu.
3. Select "Anchor Adjustment" using the jog dial and press the dial to determine the selection.
When the confirmation screen appears, select "OK". The parameter is saved and sets anchor point.
4. Adjust the image quality again and press the RESET button on the video display.
Press the RESET button to return to each saved anchor point.

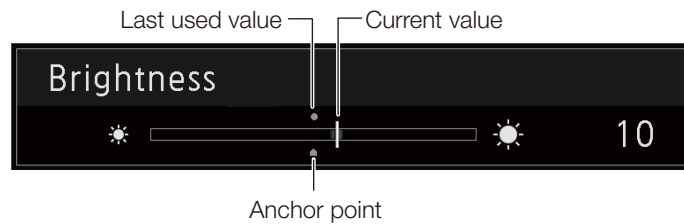





Note

- Executing "Reset" under "Adjustment" or "Reset All Settings" under "System Settings" resets saved anchor points and the settings return to their factory default values.
- When calibration is performed in "User 1-7" under "Picture Mode", the values are saved as anchor points.

Enlarging the display (Zoom function) (73)

The zoom display position can be adjusted, and the zoom magnification (2x, 4x, 8x) can be selected.

1. Press the MENU button to open the OSD menu.
2. Select "Display Settings" → "Zoom" using the jog dial.
3. Select "Zoom Preset" using the jog dial.
Select a preset zoom display.
4. Select "Position" using the jog dial.
The zoom adjustment screen is displayed.
 - To move the display position: Move the jog dial (    or rotation).
 - To return to the center: Press the RESET button.
5. When adjustments are completed, press the jog dial.
The screen returns to the original OSD menu.

Zoom 2 [x4]

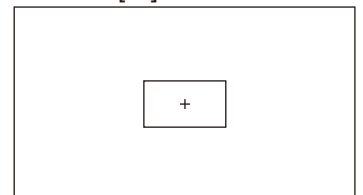

Note

- When magnifying the image and the OSD menu is not being displayed,
 - you can set the magnification ratio by pressing the jog dial.
 - You can move the display location by moving the jog dial (▲▼◀▶).
 - You can set the following functions using the CH button:
CH1: Select zoom type; CH2: Switch between zoom presets (Zoom 1/Zoom 2/Zoom 3); CH3: Zoom off

Changing Image Quality Automatically According to Input Signal

On this video display, you can automatically change the image quality according to video resolution or metadata.

■ Changing "Picture Mode" automatically (📖 67)

1. Press the MENU button to open the OSD menu.
2. Select "Channel Settings" → "Select Channel" using the jog dial.
Select the channel.
3. Select the "Channel Settings" → "Picture Mode" → "Type" using the jog dial.
Select the Type.

Changing by individual video resolution (4K/2K)

Select "4K/2K".

Changing according to video resolution (4K/2K) or metadata (SDI)

Select "Automatic".

4. Select the Picture Mode using the jog dial.

■ Changing the image quality setting according to video metadata (HDMI) (📖 59)

1. Press the MENU button to open the OSD menu.
2. Select "Adjustment" → "Picture Mode" using the jog dial.
Select "User 1" to "User 7".
3. Select the "Channel Settings" → "Picture Mode" → "Type" using the jog dial.
Select other than "L/R".
4. Select "Adjustment" → "Detail Settings" → "HDMI Link" → "Automatic Adjustment" using the jog dial.
 - Select "On".
 - See "HDMI Link" (📖 59) for the configurable settings.

Note

- When automatic changing of image quality according to video resolution (4K/2K) or SDI metadata is set, information showing which resolution (4K/2K, etc.) is selected will be displayed at the top right of the menu screen.





Resolution: 4K

Adjust image quality on left/right side of screen (image comparison mode)

You can divide the screen in two and adjust the image quality on the left and right sides of the screen individually.

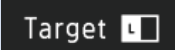
1. Press the MENU button to open the OSD menu.
2. Select "Channel Settings" → "Picture Mode" → "Type" using the jog dial.
After selecting "L/R", press the jog dial to determine the selection.
3. Select the screen to adjust image quality.
 - When the OSD menu is open:
 - In the "Adjustment" main menu, press the jog dial's ◀ button.
 - In the "Adjustment" main or sub menu, press the CH1 button.
 - When the OSD menu is not being displayed: Move the jog dial (◀▶).
 - Each time the target screen is switched, the set "Picture Mode" is displayed at the top.
4. Adjust the image quality on the selected screen.

Note

- When in Image Comparison mode, an icon showing which screen (L/R) is selected for image quality adjustment will be displayed at the right top of the "Adjustment" menu screen. 
- The functions that cannot be used when the right screen is selected are as follows.
 - Sub Menu items for "Adjustment": "Contrast", "Backlight Control", "Peak Luminance Control", "HDR/SDR View", "Calibration"
- When two screens are displayed, you can adjust the image quality on each screen individually and compare them.
 - When two screens are displaying the same image ("Single Input Dual View"  68)
 - When two screens are displaying different images ("Multi View (Dual)"  65)
 - The HDR (High Dynamic Range) and SDR (Standard Dynamic Range) displays can be tested side by side. ("HDR/SDR View"  58)

Calibration without a PC (59)

When "User 1-7" under "Picture Mode" is selected, you can perform calibration using an external sensor, without using the computer.

The supported external sensors are Konika Minolta Display Color Analyzers CA-310 and CA-210. Be sure to also read the instruction manual of the CA-310 and CA-210.

The video display can perform measurement or calibration of the display using the DP-V Color Adjustment software. Refer to the Canon website for the DP-V Color Adjustment.

1. Connect the display color analyzer to the USB port of the main unit.
2. Open the OSD menu and select "Adjustment" → "Detail Settings" → "Calibration".
Set each target value.

3. Press the jog dial and select "Start".

Please follow the information indicated on the screen.

4. Initialize the sensor.

Set the mode dial of the Universal Measuring Probe to "0-CAL".

Press the jog dial of the video display, select "OK", and execute initialization.

5. Place the universal measuring probe pointing at the center of the video display.

Set the mode dial of the universal measuring probe to "MEAS" and place the probe as shown below according to the displayed content. Press the jog dial of the video display, select "OK", and execute calibration.

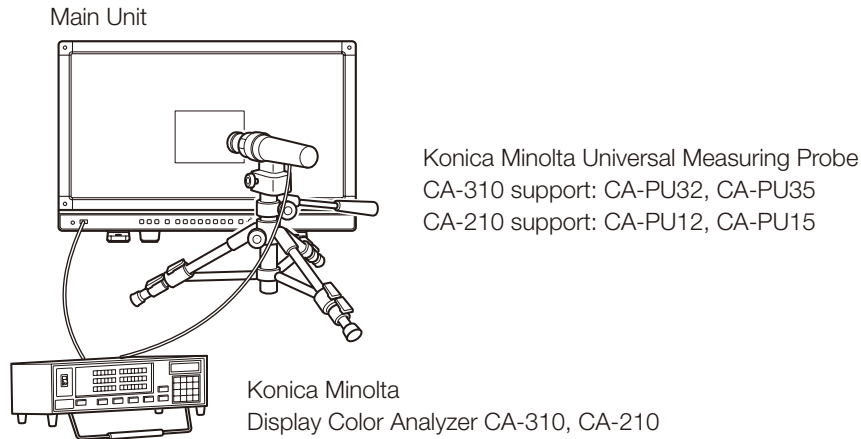

6. Finish calibration.

When the message "Calibration is completed." is displayed, press the jog dial and select "OK".

- If the message "Calibration error." is displayed.
Calibration has been terminated due to an error. The main unit returns to the state before calibration. (📖 130)
- To cancel calibration
Press the jog dial during calibration and select "Cancel". The main unit returns to the state before calibration.

Note

- Due to the characteristic of LCD panel and individual difference of CA-310 and CA-210, the calibration results may differ.
- Perform matrix calibration of the display color analyzer prior to calibration. If calibration is performed without performing matrix calibration, an error may occur. Refer to the CA-310 and CA-210 instruction manual for the detail operation.
- Warming-up is necessary to stabilize the brightness of the video display. Wait at least 10 minutes after turning on the power before calibration.
- Perform calibration in a dark room so that no external light enters the sensor. If external light enters the sensor, low brightness characteristics cannot be calibrated correctly.

Export/Import

You can export/import LUT and CDL parameters as well as main menu settings. Insert a USB memory stick into the USB port of the main unit.

■ LUT Import (📖57)

1. Press the MENU button to open the OSD menu.
2. Select "Adjustment" → "Detail Settings" → "LUT Import" using the jog dial.
3. Select the file using the jog dial.
In the "Filename" field, search and display a file with extension ".clut" in the root folder.
4. Select the LUT type using the jog dial.
 - Select the LUT type by using "User LUT", "Gamma LUT" or "Gamut LUT".
 - Refer to the "Concept Drawing of Display Image Processing and LUT". Or, also refer to the "User LUT Creation Guide" on the Canon website.
5. Select "Select LUT" using the jog dial.
Selects User LUT 1-8/Gamma LUT 1-8/Gamut LUT 1-8.
6. Select the standard color gamut using the jog dial.
Select the color gamut used when creating the LUT (when "Gamut LUT" under "LUT Type" is selected).
7. Select "Execute" using the jog dial.
When the confirmation screen appears, select "OK". Import starts.

 **Note**

- The LUT file is proprietary to Canon Video Display. Refer to the Canon website for the file format and how to create.
- Up to 1000 LUT import files are recognized.
- You can delete the imported LUT. You can specify the name of LUT (📖57).

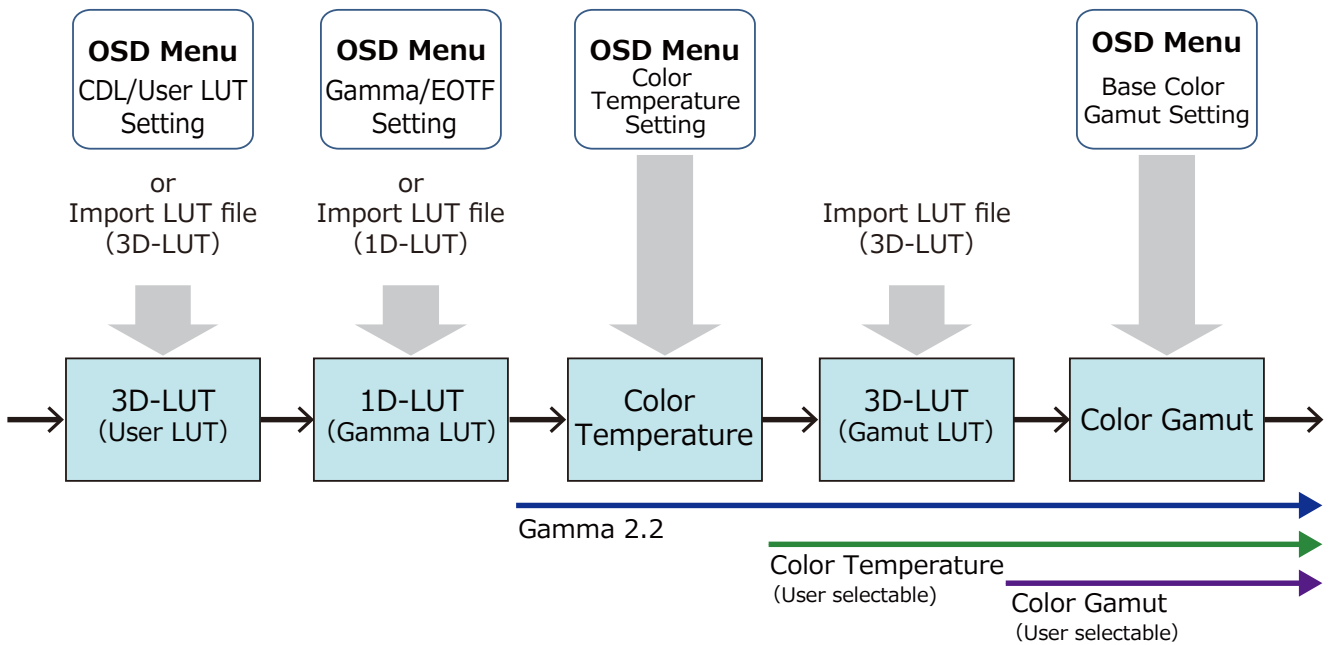

Concept Drawing of Display Image Processing and LUT

■ Export/Import Main Menu Settings (📖104)

1. Press the MENU button to open the OSD menu.
2. Select "System Settings" → "Export/Import".
3. Select "Export" or "Import" using the jog dial.

Exporting

- Select "Target" from "USB", "User 1-3" or "LAN".
Export "USB" to the USB memory and "User 1-3" to the built-in memory of the main unit. When you select "LAN", the file is exported to a display connected via LAN.
- If you selected "USB" or "User 1" to "User 3", select "Filename".
 - Factory default is "dinfo_dpv2420.dat" (V2421 "dinfo_dpv2421.dat"). You can change the name of the file to be exported to the USB memory within 16 one-byte characters including alphabetical characters, numbers, and symbols.
- If you selected "LAN", select "Display".
 - Select the display to which to export the settings from the displays connected via LAN.
- Select "Execute".
When the confirmation screen appears, select "OK". Export starts.

Importing

- Select "Target" from "USB" or "User 1-3".
Specify the destination to save the file to be imported.
- Select "Filename".
- In "Settings", select "All" or Main Menu name.
- Select "Execute".
When the confirmation screen appears, select "OK". Import starts.

Note

- After export to "User 1-3", you can select the configurations at startup from "User 1-3" in "Power on Setting" in "System Settings" (📖105).
- To export this device's settings to other Canon displays:
 - If a display model has functions with different menu settings or setting ranges, some settings will not be correctly exported (settings will not be changed, will revert to factory defaults, etc.)
 - When the export is completed, a message will appear on the target display.

■ Exporting/Importing CDL Parameters (📖 56)

1. Press the MENU button to open the OSD menu.
2. Select "Adjustment" → "CDL/User LUT" using the jog dial.
Select "CDL 1-8".
3. Select "Detail Settings" → "CDL Export" or "CDL Import".

Exporting

- Select "CDL Preset".
 - Select a file format ".ccc" or ".cdl".
 - Select "Execute".
- When the confirmation screen appears, select "OK". Export starts.

Importing

- Select "Filename".
 - Select "CDL Preset".
 - Select "Execute".
- When the confirmation screen appears, select "OK". Import starts.

Note

- The exported file is automatically saved under the name "YYYYMMDDhhmmss_Preset name.ccc (cdl)".
- Up to 1000 CDL import files are recognized.

Set Date/Time (📖 101)

This section describes how to set the Date/Time. The Date/Time of this video display will be reset if the power cord is not connected for about 20 days.

1. Press the MENU button to open the OSD menu.
2. Select "System Settings" → "Date/Time".
A screen to input the Date/Time appears.
3. Set the Date/Time using the jog dial.
The selection frame moves and numbers change as you operate the jog dial. Repeat until you complete setting the year, month, date, hour, and minute.
4. Press the jog dial when you are finished.
The selection frame moves to "OK".
5. Check the content and press the jog dial to confirm the settings.

Reference

- When selecting "Cancel" or pressing MENU button before selecting "OK", the settings will be reset and the previous screen will be displayed.

Inputting Characters

This section describes how to input the characters.

1. Press the MENU button to open the OSD menu.
2. The character input screen appears automatically when character input is required.

Move the selection frame to the location to enter characters using the jog dial (◀▶).

3. Select characters using the jog dial (▲▼ or rotation).

The following characters can be selected: Press ▲▼ buttons to display them one by one.

Alphanumeric characters: A to Z, a to z, 0 to 9

Symbols: , . : ; ' ` - + / = % & ! ? # _ | \$ ^ ~ @ { } [] < > () space

Characters that cannot be entered are automatically skipped.

4. Repeat steps 2 and 3 until the desired text has been inputted.
5. Press the jog dial when you are finished.
The selection frame moves to "OK".
6. Check the content and press the jog dial to confirm the settings.

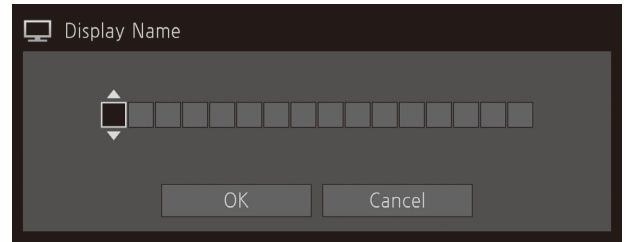

Reference

- When selecting "Cancel" or pressing MENU button before selecting "OK", the settings will be reset and the previous screen will be displayed.
- To erase characters in the selection frame or reset it, press the RESET button on the video display.

Using the Function (F) Buttons

You can assign functions to the F buttons on the video display to execute them instantly.

1. **Press the MENU button to open the OSD menu.**
2. **Select "System Settings" → "Function/Channel Button" → "Display Function" or "Display Function (CDL)" and press the jog dial to determine the selection.**
A new window opens and displays button names F1 to F8.
3. **Select the name of the button using the jog dial and press the jog dial to determine the selection.**
The selection frame moves to next OSD menu level.
4. **Select the function to assign using the jog dial.**
See "Display Function" or "Display Function (CDL)" (📖 101, 106) for the available functions.
5. **Press the jog dial to determine the selection.**
The setting is confirmed.

Reference

- Holding the F button down will display the function selection screen, and you can set the function you wish to register.
- Turning "System Settings" → "OSD Settings" → "Function Button Guide" to "On" will mean that when OSD is not displayed, pressing/moving (▲▼◀▶, or rotate) the jog dial will allow you to see the list of functions registered to the F button. Selecting a function from the list and pressing/moving (▶) the jog dial will display the detailed settings screen, or execute that function.

Using the Channel (CH) Button

You can assign channels (various settings related to input signal) to the CH buttons on the video display and switch channels instantly.

1. **Press the MENU button to open the OSD menu.**
2. **Select "System Settings" → "Function/Channel Button" → "Display Channel" and press the jog dial to determine the selection.**
A new window opens and displays button names CH1 to CH3.
3. **Select the name of the button using the jog dial and press the jog dial to determine the selection.**
The selection frame moves to next OSD menu level.
4. **Select the channel to assign using the jog dial.**
See "Channel Settings" (📖 64) for the configurable settings.
5. **Press the jog dial to determine the selection.**
The setting is confirmed.

The following content is assigned to channel buttons on the video display by factory default.

CH	CH1	CH2	CH3	
Input Configuration	V2420	3G/HD-SDI	HDMI	3G-SDI RAW
	V2421	12-3G/HD-SDI	HDMI	3G-SDI RAW
Select Input Signal	Automatic	Automatic	Automatic	
Image Division	Automatic	Automatic	Automatic	
Link Order	Automatic	Automatic	Automatic	
Format	Automatic	Automatic	Automatic	
Audio Input	Automatic	Automatic	Automatic	
Marker/TC/CameraInfo Input	Input A	Input A	Input A	
Internal Sync	Off	Off	Off	
Channel Name	(Blank)	(Blank)	(Blank)	
Picture Mode → Type	Normal	Normal	Normal	
Picture Mode Picture Mode L Resolution 4K	ITU-R BT.709	ITU-R BT.709	CINEMA EOS SYSTEM	
Picture Mode R Resolution 2K	ITU-R BT.709			
Payload	UHD/PQ	User 1 (2020 PQ)		
	UHD/HLG	User 2 (2020 HLG)		
	UHD	ITU-R BT.2020		
	709/PQ	—		
	709/HLG	—		
	709	ITU-R BT.709		
	VANC	—		
	Unknown	—		
Camera	CINEMA EOS SYSTEM	CINEMA EOS SYSTEM		
	ARRI	User 6		
	VARICAM	User 7		
Single Input Dual View	Off	Off	Off	
Separator	Off	Off	Off	

 **Note**

- Holding the CH button down displays the channel list, allowing the user to select the desired channel. However, in the following cases, a list of input signals will be displayed and the user can temporarily switch signals: When a 12G-SDI signal or 6G-SDI signal is input; or when video that can be displayed simultaneously with a 12G-SDI or 6G-SDI signal is input and "Select Input Signal" is set to "Automatic" (**V2421**).

Checking Signal Information and Status of the Main Unit

The video display is equipped with a banner function which displays signal information or the status of the main unit.

1. Press the jog dial when the OSD menu is closed.

The channel name, signal information, and status of the main unit will be displayed in the banner. It will automatically disappear after 6 seconds.

Note

- You can select how the banner is displayed ("Banner" [102](#)).
- You can monitor the input signal status. ("Signal Monitoring" [88](#))
- For more detailed signal information, please refer to the section on "Signal Information" ([108](#)).
- The "Detecting sync." banner will continue to appear until the input signal is synchronized.

Operating the video display using an external device [LAN terminal]

The video display supports Television Systems Ltd.'s "TSL UMD Protocol Ver. 5.0". You can operate the video display using an external device connected to the LAN terminal and display characters and tally lights on the screen. There are two tally lights, on the left and right. Up to 16 characters can be displayed.

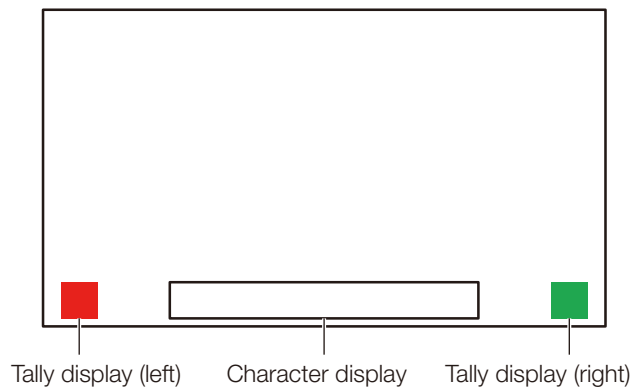

1. Connect an external control device to the LAN terminal.
2. Set "SCREEN" and "INDEX" to "0x0000" in the TSL Protocol settings.
3. Press the MENU button to open the OSD menu.
4. Select "Network/IMD Settings" → "In Monitor Display" and press the jog dial to determine the selection.
5. Select "Control" → "TSL Ver. 5.00" using the jog dial.
 - This will allow operation from an external control device, and display characters and tally lights.
6. Select "Position" → "Top" or "Bottom" using the jog dial.
 - This sets the position where characters and tally lights will be displayed.

Note

- When "Multi View (Dual)" or "Multi View (Quad)" is displayed, set the "INDEX" setting to from "0x0001" to "0x0004".
- The port number for the controlling is fixed at "45000".
- With "In Monitor Display" you can also display user-selected characters on the screen. ([100](#))

Operating the video display using an external device [USB terminal: Wi-Fi connection]

A Wi-Fi adapter can be connected to the USB terminal of the video display so that the video display can be connected to a portable terminal in the Wi-Fi network environment in use. The following two methods can be used to connect:

Infrastructure: This method connects to Wi-Fi via an access point.

Access Point: This device acts as an access point, and this method connects the device directly to the Wi-Fi device.

- Network settings such as IP address and subnet mask are acquired automatically.
- Supported encryption schemes
Infrastructure: WEP64 (ASCII), WEP128 (ASCII), WPA-TKIP, WPA-AES (CCMP), WPA2-TKIP, WPA2-AES (CCMP)
Access Point: WPA2-AES (CCMP)

CAUTION

- Note that we cannot accept any liability for damages that arise as a result of incorrect settings made on the network to use network functions and for damage that arise as a result of use of this function.
- Avoid connecting to Wi-Fi or network environments that are not protected by appropriate security measures. Remember to change the default password when setting the access point. Doing so may cause the customers' personal information or other important information to leak to a third party. When not using Wi-Fi, set "Wi-Fi" → "Control" to "Off".
- The specifications and restrictions of Wi-Fi connection methods differ depending on the Wi-Fi network in use.
- There is no guarantee that the Wi-Fi adapter functions in use will work on the video display. For information about Wi-Fi adapter related defects, contact the device manufacturer. Also, in various countries and regions, approval is needed to use the Wi-Fi adapter, and use of non-approved Wi-Fi adapters is not permitted. If you are unclear of whether or not use is approved, check with the device manufacturer.

Note

- Refer to the Canon website for a list of supported devices (Wi-Fi adapters).
- For details on how to use the Wi-Fi adapter, precautions for use, how to set access points, and other information, either refer to the device Instruction Manual or contact the manufacturer.
- Up to 24 access points can be displayed and selected on the video display.

1. **Connect the Wi-Fi adapter to the USB terminal.**
2. **Press the MENU button to open the OSD menu.**
3. **Select "Network/IMD Settings" → "Wi-Fi", and press the jog dial to determine the selection.**

When using the "Infrastructure" method

4. **Select "Control" → "Infrastructure" using the jog dial.**
5. **Set the access point to connect to.**
6. **If a password is needed when connected to an access point, enter the password (99).**
 - This is set using up to 24 alpha-numerical characters and symbols. The following characters can be entered.
Alphanumeric characters: A to Z, a to z, 0 to 9
Symbols: _ or -

When using the "Access Point" method

4. Select "Control" → "Off" using the jog dial.
5. Select "Access Point" using the jog dial (📖99).
 - Enter the SSID. This is set using up to 24 alpha-numerical characters and symbols.
 - Sets the communication mode.
 - Sets the channel.
 - Enter the password. This is set using between 8 and 24 alpha-numerical characters and symbols.
 - "SSID", "Password": The following characters can be entered.
 - Alphanumeric characters: A to Z, a to z, 0 to 9
 - Symbols: _ or -
6. Select "Control" → "Access Point" using the jog dial.

Use a web browser to remotely operate the video display

A web browser can be used to remotely operate the video display using a computer terminal connected to the LAN terminal or a portable terminal (📖 36) connected via a Wi-Fi adapter to the USB terminal. From the device connected to the network, you can change image quality settings or switch channels.

This function checks operation using the following web browsers.

- Safari (Apple)
- Google Chrome (Google)

* Correct operation cannot be guaranteed on all supported OS or web browser editions.

⚠ CAUTION

- Remember to change the initial settings for ID and Password when using this function.

📝 Note

- Access is only possible from a single terminal.
- This function may not work if the video display is accessed using LAN and a Wi-Fi adapter, at the same time.
- Opening multiple pages in multiple tabs on the web browser can cause it to not function properly.
- Executing "Capture" in the "View" screen can cause the video on this video display to pause temporarily.
- Operating the video display itself while it is being accessed from a web browser can cause the network connection to be lost.
- A delay may occur in video display or in the various settings depending on the network environment and communication conditions.
- The IP address can be checked in the "System Information" screen.
- The operation screen only displays English.

1. **Connect external control devices via the network.**
2. **Press the MENU button to open the OSD menu.**
3. **Select "Network/IMD Settings" → "Web", and press the jog dial to determine the selection.**
4. **Select "Control" → "On" using the jog dial.**
5. **Select "User ID" and "Password" using the jog dial. (📖 99)**
 - User ID: Enter the user ID. This is set using up to 16 alpha-numerical characters and symbols.
Password: Enter the password. This is set using between 8 and 16 alpha-numerical characters and symbols.
The following characters can be entered.
Alphanumeric characters: A to Z, a to z, 0 to 9
Symbols: _ or -
6. **Start up a web browser on the device connected to a network.**
7. **Enter the IP address of this video display in the address bar.**
 - The remote operation screen is displayed on the web browser.
 - When the basic authentication screen is displayed, enter the user ID and password.
8. **When operation ends, close the web browser.**

■ Operation screen

"View" screen

After pressing one of the image capture buttons, the captured image will be displayed. You can also operate the CH buttons and F buttons (function/channel buttons).



"Control" screen

Allows the Picture Mode, Channel, and various marker displays to be set.

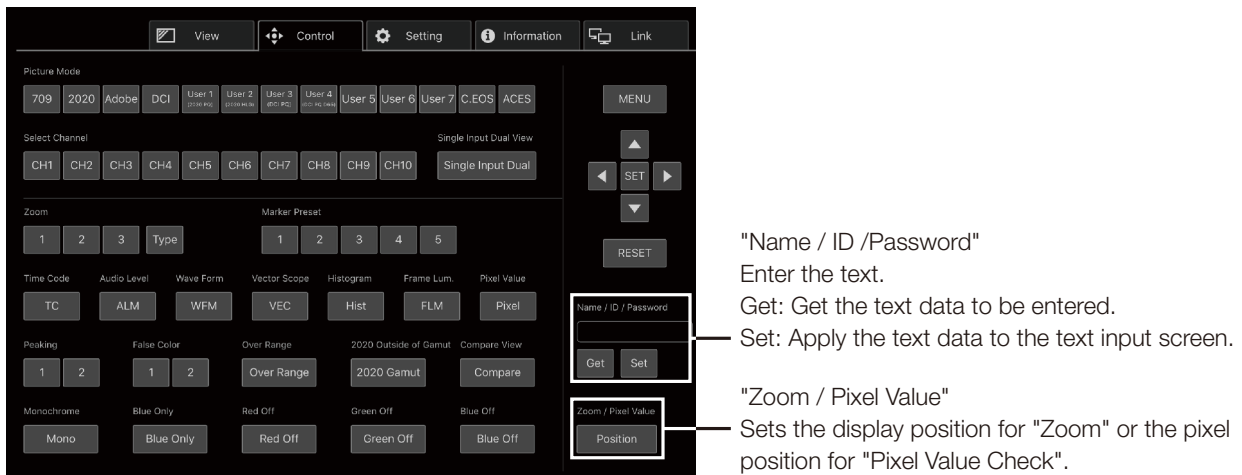

"Setting" screen

You can import LUT, export "Frame Luminance Monitor", and import or export this video display's settings.

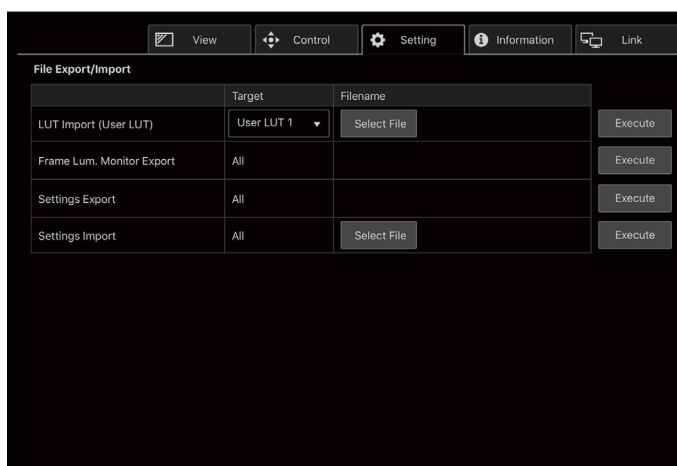

"LUT Import (User LUT)"

Imports a LUT. When the LUT import is completed, the setting of the imported LUT will be applied to the current "Picture Mode"'s "CDL/User LUT".

"Frame Lum. Monitor Export"

Exports "Frame Luminance Monitor". Exporting "Frame Luminance Monitor" will create a "latest.csv" file for the luminance in the final screen and an "all.tar.gz" file (a file compressed using the tar.gz method) that contains all acquired luminance information.

"Information" screen

Displays the settings for "Adjustment" and "Channel Settings", and information for "Signal Information" and "System Information".

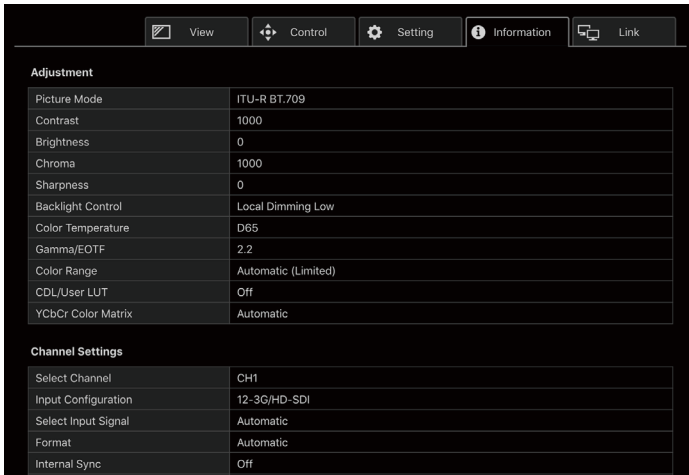

"Link" screen

You can display a list of the display connected via LAN to this video display, set "Display Setting Link", and change the display names.

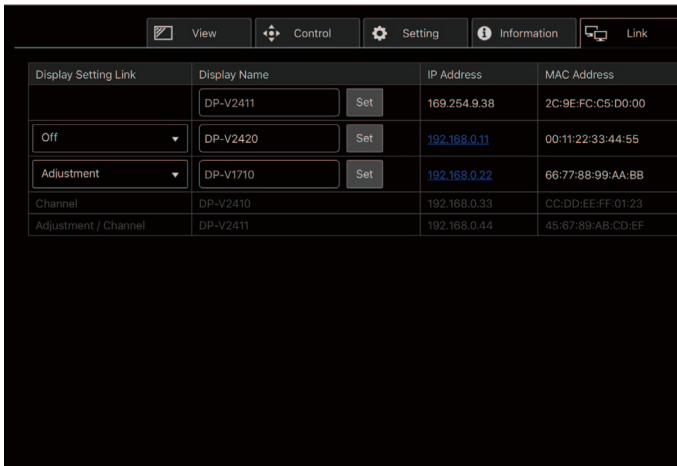

OSD Menu

OSD Menu Index

Adjustment (📖 49)

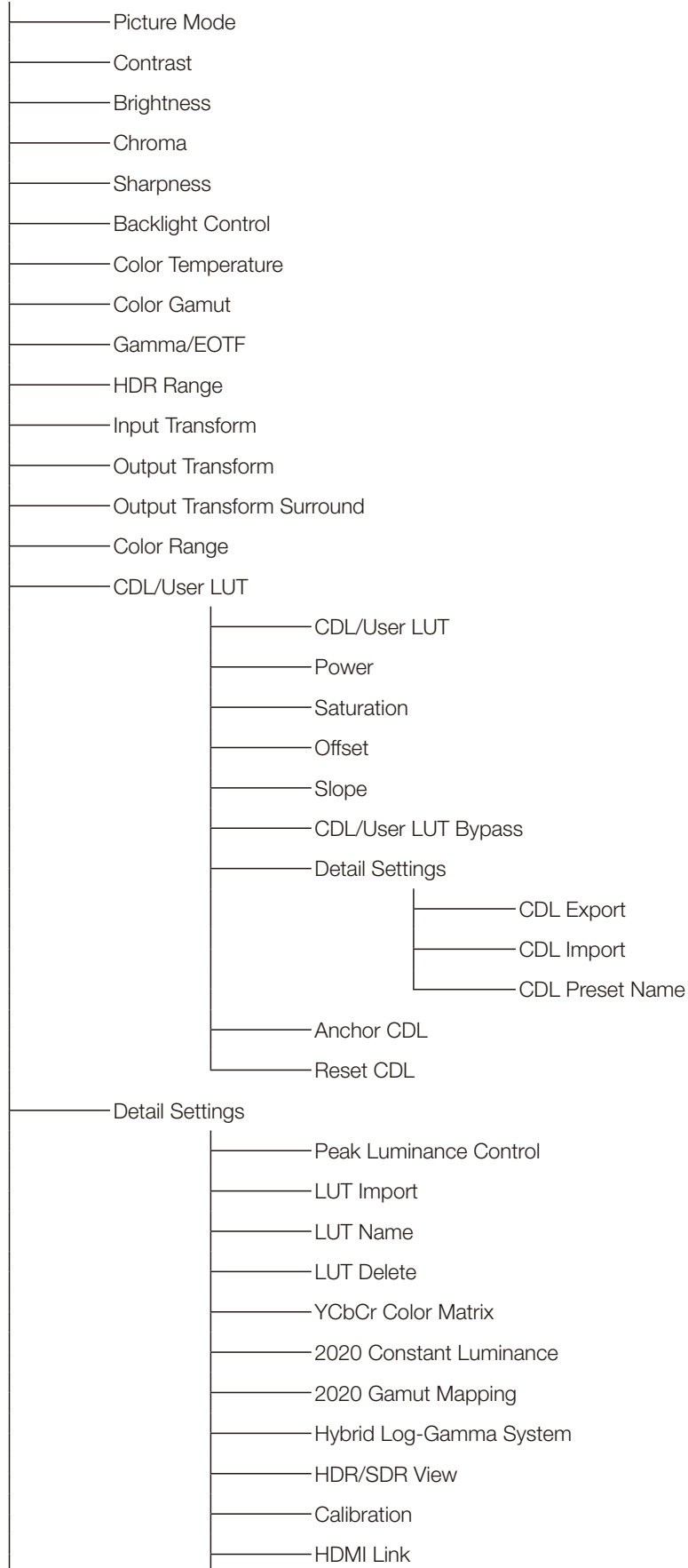

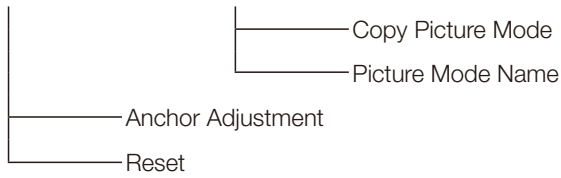

Channel Settings (📖 64)

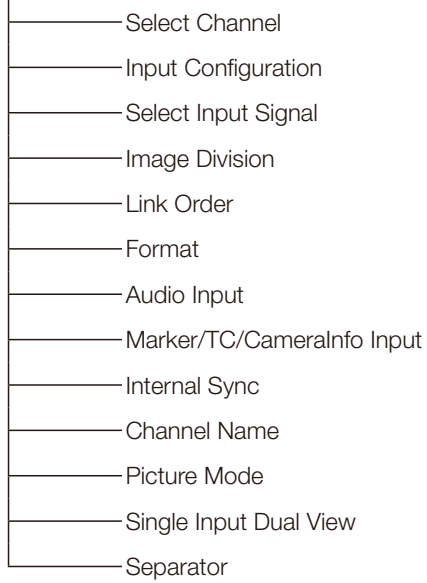

Display Settings (📖 71)

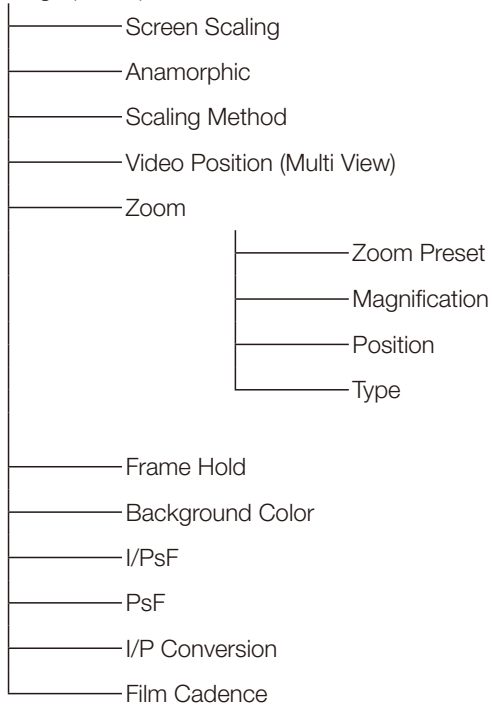

Audio Settings (📖 75)

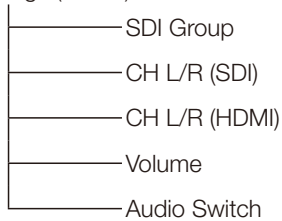

Marker Settings (76)

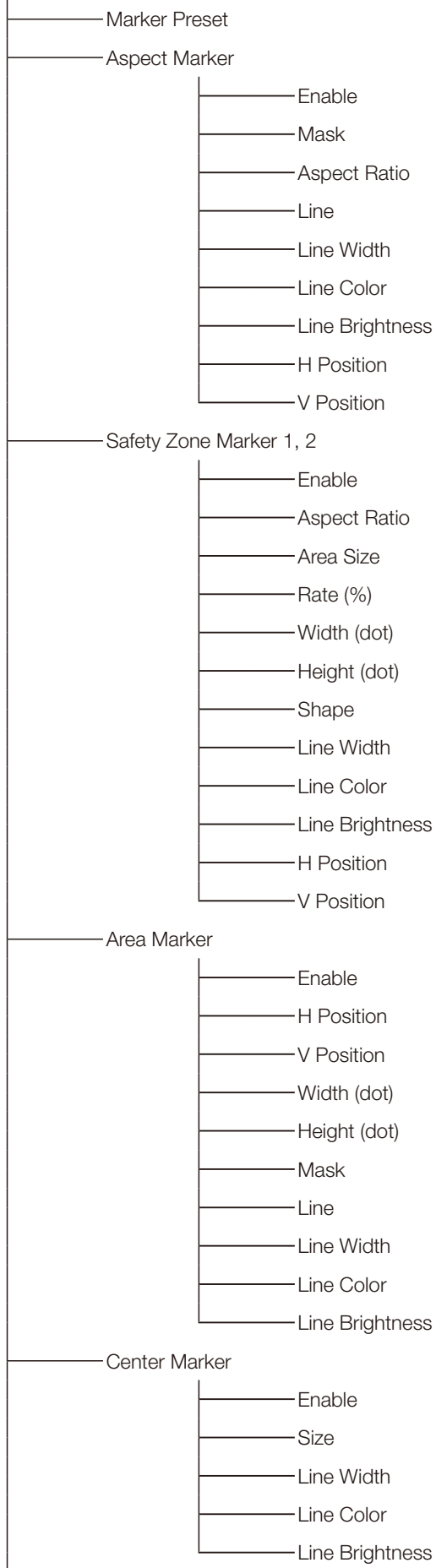

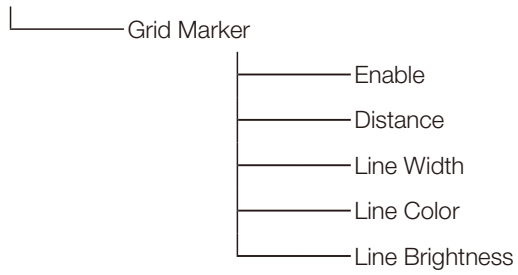

Function Settings (📖 81)

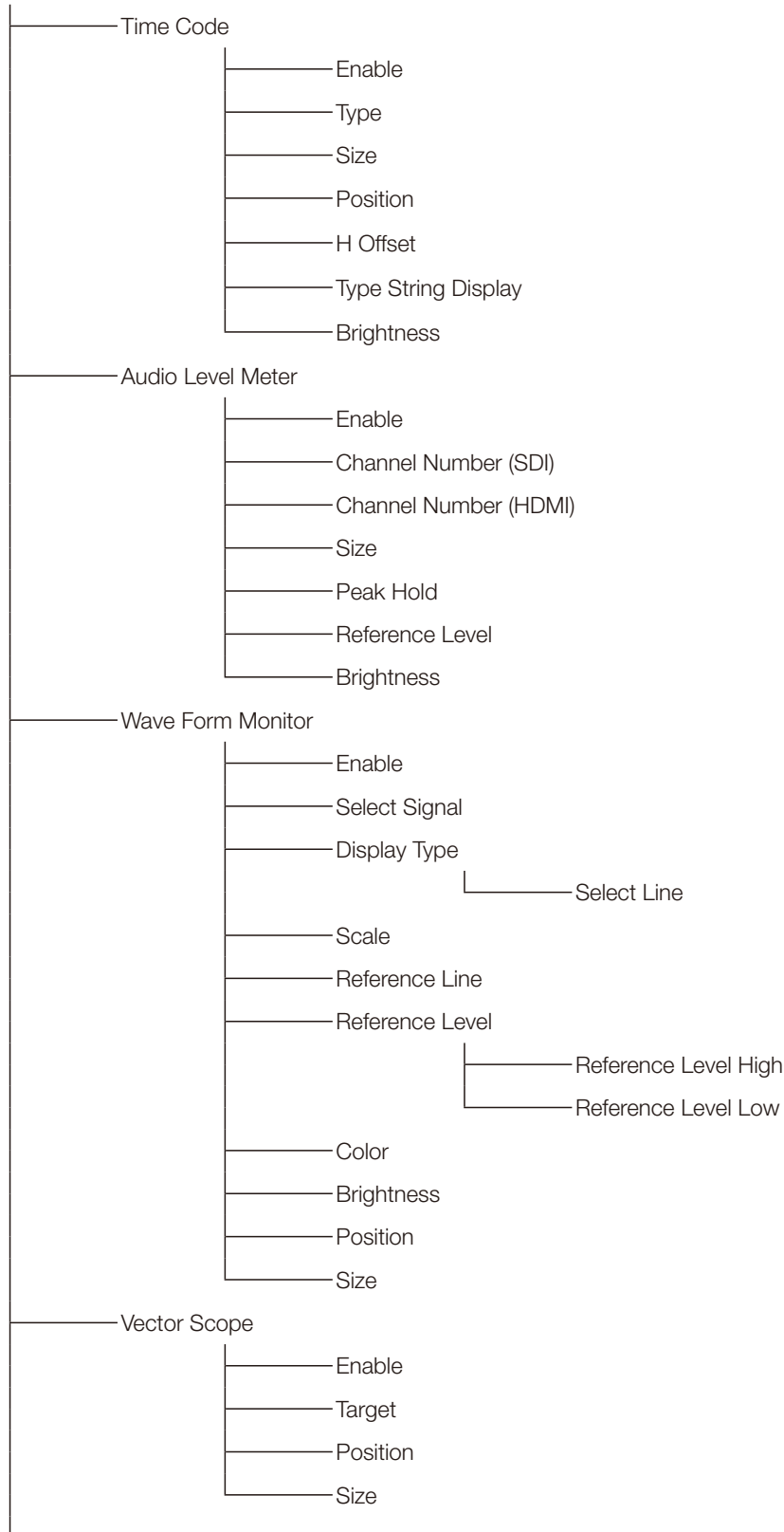

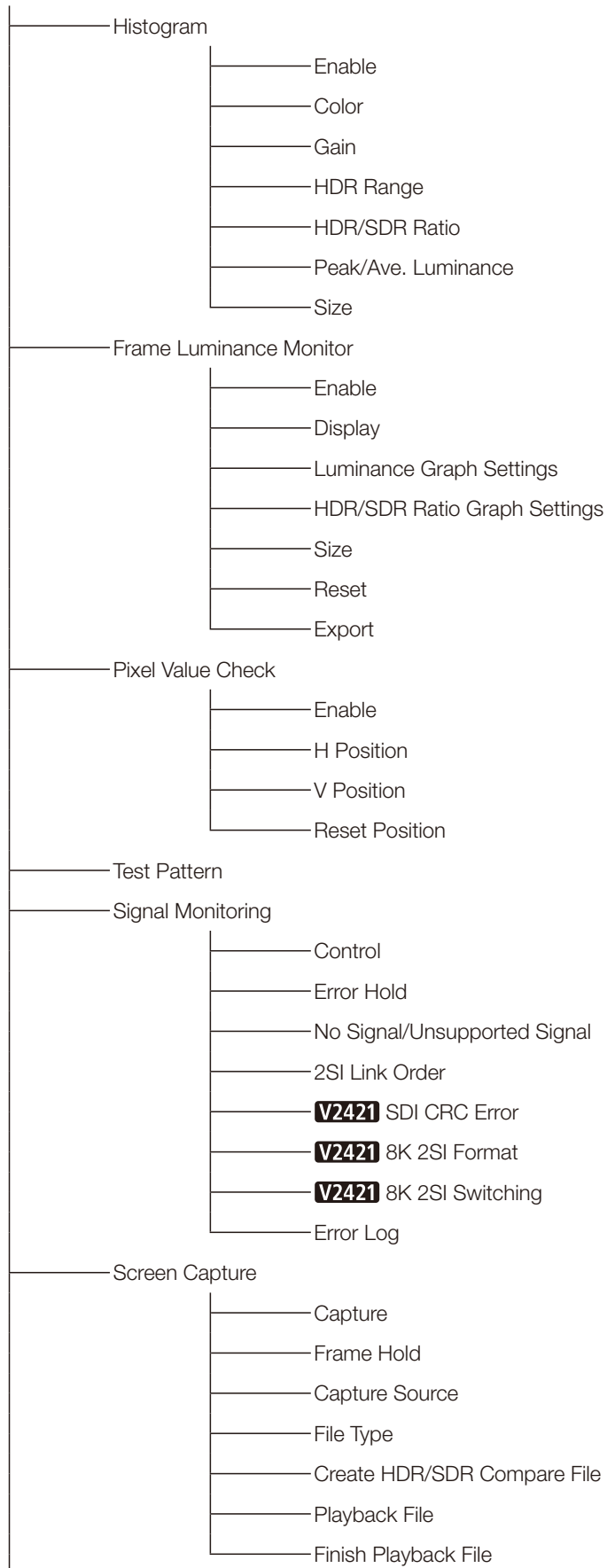

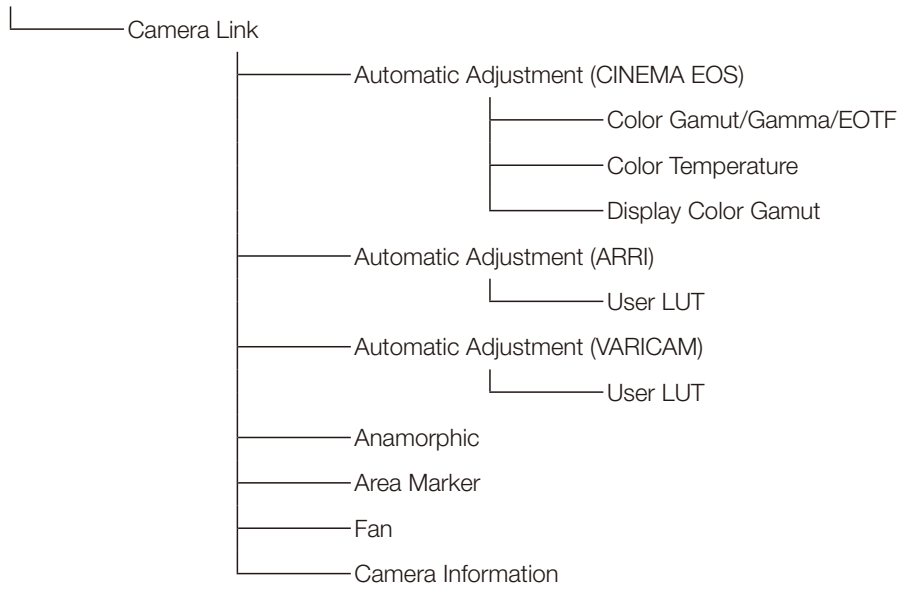

Picture Function Settings (📖 94)

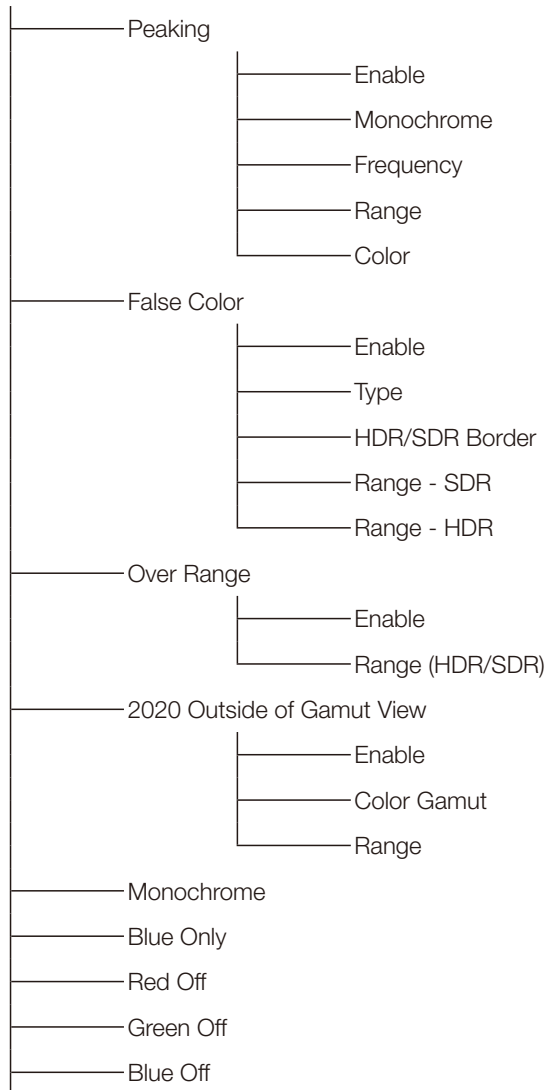

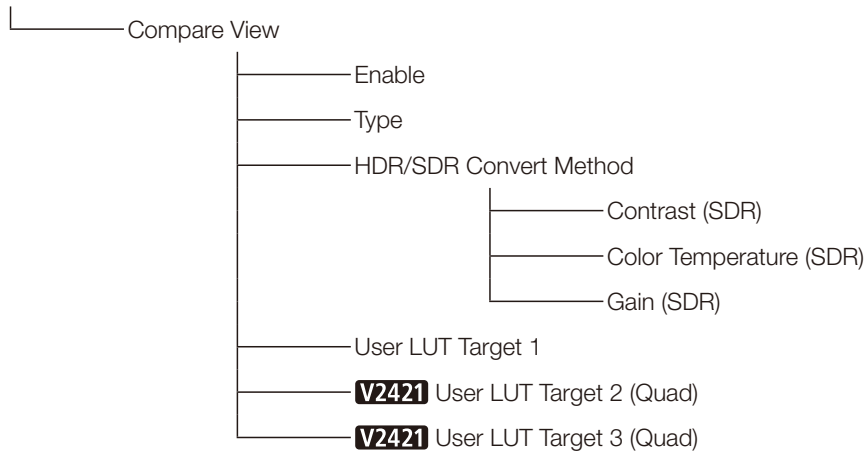

Network/IMD Settings (📖99)

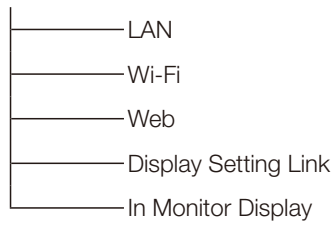

System Settings (📖101)

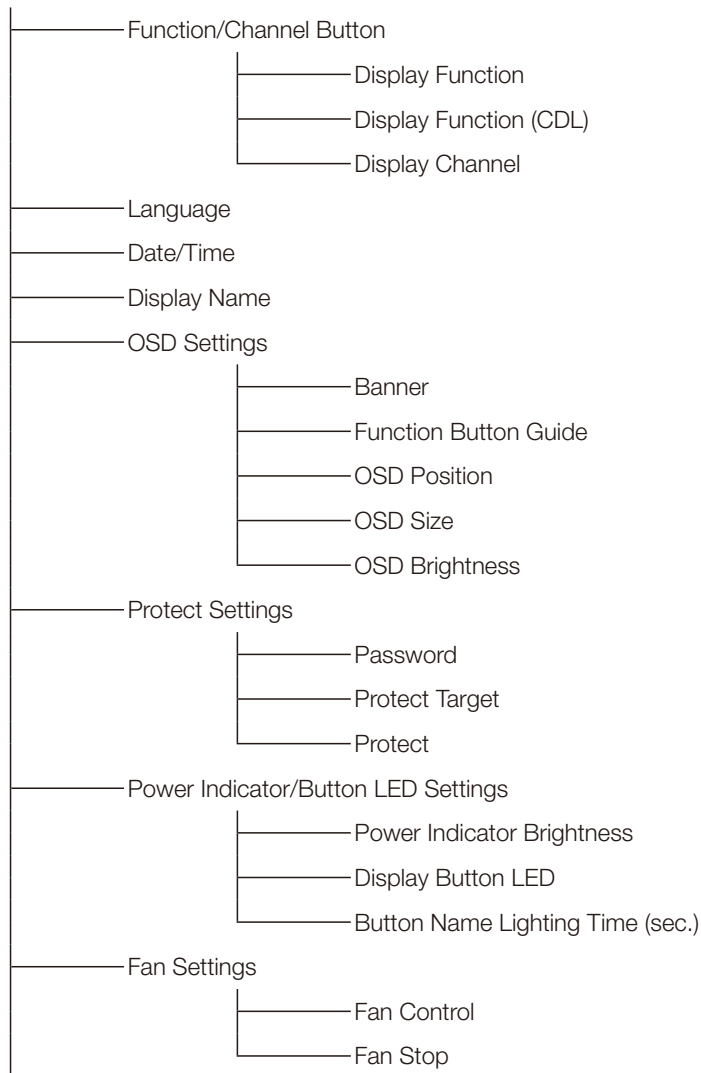

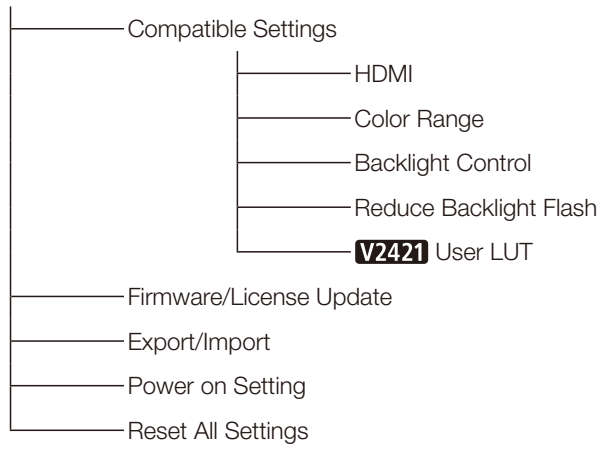



Signal Information (📖 108)



System Information (📖 108)

Adjustment

This menu is used to adjust the image quality and perform calibration without a PC. The factory defaults differ according to the "Picture Mode" setting. (📖61)

Item	Setting Options (underline indicates factory default)
Picture Mode	<p>Select a preset mode.</p> <p>SMPTE-C, EBU, ITU-R BT.709, ITU-R BT.2020, Adobe RGB, DCI-P3: Mode set to the brightness, color temperature, gamma/EOTF, and color gamut of the three primary colors chromaticity points of each standard.</p> <p>User 1-7 (User 1 (2020 PQ), User 2 (2020 HLG), User 3 (DCI PQ), User 4 (DCI PQ D65), User 5 ~ User 7): Custom modes. Set each item of "Adjustment". You can change the mode name within 24 one-byte characters including alphabetical characters, numbers, and symbols (📖60).</p> <p>CINEMA EOS SYSTEM: Canon Log is ideal when viewing image captured with Cinema EOS camera/video camera. Using Camera Link, you can have the image quality setting change automatically ("Automatic Adjustment (CINEMA EOS)" 📖90).</p> <p>ACESproxy (ver. 1.0.1): A mode to display ACESproxy videos in optimum gamma/EOTF and color gamut.</p> <p>📌 Note</p> <ul style="list-style-type: none"> "ACESproxy (ver. 1.0.1)" cannot be set when "Channel Settings" → "Picture Mode" → "Type" are "L/R", "4K/2K" or "Automatic".
Contrast	<p>Adjusts the white level of the image. (Increments of 1)</p> <p>0 to 6000</p> <p>❖ When "Peak Luminance Control" in "Detail Settings" is set to "On", the settable range is shown below. When "Peak Luminance Control" is "On", "Contrast [Peak Control]" is displayed.</p> <p>0 to 12000</p> <p>📌 Note</p> <ul style="list-style-type: none"> When "Channel Settings" → "Picture Mode" → "Type" is "L/R", "Contrast" cannot be adjusted at the "Picture Mode" setting for the right screen. The right screen's setting will be the same as set for the left screen.
Brightness	<p>Adjusts the black level of the image. (Increments of 1)</p> <p>-500 to 500</p>
Chroma	<p>Adjusts the color saturation of the image (color depth). (Increments of 1)</p> <p>0 to 2000</p> <p>📌 Note</p> <ul style="list-style-type: none"> Can only be adjusted when "CDL/User LUT" is "CDL 1-8" or "Off".
Sharpness	<p>Adjusts the sharpness of the image. (Increments of 1)</p> <p>0 to 100</p>
Backlight Control	<p>Switches the backlight control method.</p> <p>Local Dimming (High, Low): Local dimming technology controls the amount of light emitted by the backlight for each display area. The backlight of bright area is increased and the dark area is decreased according to the displayed content.</p> <p>Off: No backlight dimming is applied.</p> <p>📌 Note</p> <ul style="list-style-type: none"> When "Peak Luminance Control" is set to "On", you cannot select "Backlight Control". When "Channel Settings" → "Picture Mode" → "Type" is "L/R", "Backlight Control" cannot be set at the "Picture Mode" setting for the right screen. The right screen's setting will be the same as set for the left screen.

Item	Setting Options (underline indicates factory default)
Color Temperature	<p>Sets the color temperature.</p> <p>D93, D65, D61, D60, D56, D50, DCI-P3: Select from preset color temperatures.</p> <p>D65 Custom: This preset is for adjusting the color of the video display and displays having different display characteristics. The gain and bias are adjusted based on D65.</p> <p>Gain R/G/B, Bias R/G/B: Can be adjusted in increments of 1 when a preset color temperature is selected.</p> <p>Gain R/G/B: 0 to 1023</p> <p>Bias R/G/B: -500 to 500</p> <p>Custom (xy): You can adjust CIE x, y in increments of 0.001.</p> <p>x: 0.260 to 0.360</p> <p>y: 0.260 to 0.360</p> <p>Off: Color temperature is not set.</p> <p> Note</p> <ul style="list-style-type: none"> • "Custom (xy)" and "Gain R/G/B" or "Bias R/G/B" cannot be selected at the same time. • When "Gain R/G/B" or "Bias R/G/B" value is adjusted, an asterisk "*" is displayed by color temperature preset mode. • The displayed color coordinates (x, y) are just a guide and not guaranteed absolute values.
Color Gamut	<p>Color gamut can be selected when "User 1-7" or "CINEMA EOS SYSTEM" is selected for "Picture Mode".</p> <p>SMPTE-C, EBU, ITU-R BT.709, ITU-R BT.2020, Adobe RGB, DCI-P3: Color gamut compliant to each standard.</p> <p>Native: Color gamut that can be displayed by this video display.</p> <p>Cinema Gamut to 709, Cinema Gamut to 2020, Cinema Gamut to DCI, DCI-P3+ to 709, DCI-P3+ to DCI: Modes where the color gamut is converted to monitor Cinema Gamut and DCI-P3+ videos recorded by the CINEMA EOS SYSTEM cameras.</p> <p>S-Gamut3 to 709, S-Gamut3 to 2020, S-Gamut3 to DCI, S-Gamut3.Cine to 709, S-Gamut3.Cine to 2020, S-Gamut3.Cine to DCI: Preset modes where the color gamut is converted.</p> <p>Gamut LUT 1 to Gamut LUT 8: Selects an external LUT.</p> <p> Note</p> <ul style="list-style-type: none"> • "Color Gamut" cannot be set in the following cases. <ul style="list-style-type: none"> - When "CDL/User LUT" → "ARRI (Rec2100-PQ-1K-100)", "ARRI (Rec2100-HLG-1K-200)", "VARICAM (V-Log to V-709)", "2020 PQ to 2020 SDR", "2020 PQ to 709 SDR", "2020 HLG to 709 HLG" or "2020 HLG to 709 SDR" is selected. • For checking the video captured with Cinema EOS cameras, please refer to the "Parameter of Cinema EOS cameras and video display ( 90)" in "Adjustment".

Item	Setting Options (underline indicates factory default)
Gamma/EOTF	<p>Sets the Gamma/EOTF. 1.0, 2.2, 2.35, 2.4, 2.6, ITU-R BT.1886, Canon Log, Canon Log 2, Canon Log 3, S-Log2 (HDR), S-Log3 (HDR): Select the preset gamma. SMPTE ST 2084 (PQ), Hybrid Log-Gamma, Hybrid Log-Gamma RGB, Canon Log (HDR), Canon Log 2 (HDR), Canon Log 3 (HDR): Select the gamma/EOTF for HDR display. Gamma LUT 1 to Gamma LUT 8: Selects an external LUT. Off: Gamma is not set.</p> <p> Note</p> <ul style="list-style-type: none"> • About "Hybrid Log-Gamma" <ul style="list-style-type: none"> - This video display supports the following two methods. <ul style="list-style-type: none"> "Hybrid Log-Gamma": This method processes the system gamma for the Y signal (Compliant with ITU-R BT.2100). "Hybrid Log-Gamma RGB": This method processes the system gamma for the RGB signal. - If using "Hybrid Log-Gamma" then the system gamma value will be displayed in the "Setting Options" on the menu screen. • Not settable in the following cases: <ul style="list-style-type: none"> - When "ACESproxy (ver. 1.0.1)" is selected in "Picture Mode" - When "CDL/User LUT" → "ARRI (Rec2100-PQ-1K-100)", "ARRI (Rec2100-HLG-1K-200)", "VARICAM (V-Log to V-709)", "2020 PQ to 2020 SDR", "2020 PQ to 709 SDR", "2020 HLG to 709 SDR" is selected. • For checking the captured video with Cinema EOS cameras and ARRI / Panasonic cinema cameras, please refer to "Camera Link" → "Automatic Adjustment" ( 90).

The relationship between "Color Gamut" and "Gamma/EOTF" that can be selected is shown below. When "Color Gamut" is changed, "Gamma/EOTF" is changed to the underlined value (default value) when the current "Gamma/EOTF" settings are not selectable.



Picture Mode	Color Gamut	Selectable Gamma/EOTF
SMPTE-C	Cannot be selected	Off, 1.0, <u>2.2</u> , 2.35, 2.4, 2.6, ITU-R BT.1886, SMPTE ST 2084 (PQ), Canon Log, Canon Log (HDR), Gamma LUT 1 to Gamma LUT 8
EBU		Off, 1.0, 2.2, <u>2.35</u> , 2.4, 2.6, ITU-R BT.1886, SMPTE ST 2084 (PQ), Canon Log, Canon Log (HDR), Gamma LUT 1 to Gamma LUT 8
ITU-R BT.709, ITU-R BT.2020		Off, 1.0, <u>2.2</u> , 2.35, 2.4, 2.6, ITU-R BT.1886, SMPTE ST 2084 (PQ), Hybrid Log-Gamma, Hybrid Log-Gamma RGB, Canon Log, Canon Log (HDR), Canon Log 2, Canon Log 2 (HDR), Canon Log 3, Canon Log 3 (HDR), S-Log2 (HDR), S-Log3 (HDR), Gamma LUT 1 to Gamma LUT 8
Adobe RGB		Off, 1.0, <u>2.2</u> , 2.35, 2.4, 2.6, ITU-R BT.1886, Gamma LUT 1 to Gamma LUT 8
DCI-P3		Off, 1.0, 2.2, 2.35, 2.4, <u>2.6</u> , ITU-R BT.1886, SMPTE ST 2084 (PQ), Canon Log, Canon Log (HDR), Canon Log 2, Canon Log 2 (HDR), Canon Log 3, Canon Log 3 (HDR), S-Log2 (HDR), S-Log3 (HDR), Gamma LUT 1 to Gamma LUT 8
CINEMA EOS SYSTEM, User 1-7	SMPTE-C	Off, 1.0, <u>2.2</u> , 2.35, 2.4, 2.6, ITU-R BT.1886, SMPTE ST 2084 (PQ), Canon Log, Canon Log (HDR), Gamma LUT 1 to Gamma LUT 8
	EBU	Off, 1.0, 2.2, <u>2.35</u> , 2.4, 2.6, ITU-R BT.1886, SMPTE ST 2084 (PQ), Canon Log, Canon Log (HDR), Gamma LUT 1 to Gamma LUT 8
	ITU-R BT.709, ITU-R BT.2020	Off, 1.0, <u>2.2</u> , 2.35, 2.4, 2.6, ITU-R BT.1886, SMPTE ST 2084 (PQ), Hybrid Log-Gamma, Hybrid Log-Gamma RGB, Canon Log, Canon Log (HDR), Canon Log 2, Canon Log 2 (HDR), Canon Log 3, Canon Log 3 (HDR), S-Log2 (HDR), S-Log3 (HDR), Gamma LUT 1 to Gamma LUT 8
	Adobe RGB	Off, 1.0, <u>2.2</u> , 2.35, 2.4, 2.6, ITU-R BT.1886, Gamma LUT 1 to Gamma LUT 8
	DCI-P3	Off, 1.0, 2.2, 2.35, 2.4, <u>2.6</u> , ITU-R BT.1886, SMPTE ST 2084 (PQ), Canon Log, Canon Log (HDR), Canon Log 2, Canon Log 2 (HDR), Canon Log 3, Canon Log 3 (HDR), S-Log2 (HDR), S-Log3 (HDR), Gamma LUT 1 to Gamma LUT 8
	Native	Off, 1.0, <u>2.2</u> , 2.35, 2.4, 2.6, ITU-R BT.1886, SMPTE ST 2084 (PQ), Gamma LUT 1 to Gamma LUT 8
	Cinema Gamut to 709, Cinema Gamut to 2020	2.2, Canon Log, Canon Log (HDR), Canon Log 2, <u>Canon Log 2 (HDR)</u> , Canon Log 3, Canon Log 3 (HDR)
	Cinema Gamut to DCI	Canon Log, Canon Log (HDR), Canon Log 2, <u>Canon Log 2 (HDR)</u> , Canon Log 3, Canon Log 3 (HDR)
	DCI-P3+ to 709, DCI-P3+ to DCI	Canon Log, <u>Canon Log (HDR)</u>
	S-Gamut3 to 709 S-Gamut3 to 2020 S-Gamut3.Cine to 709 S-Gamut3.Cine to 2020	Off, 1.0, <u>2.2</u> , 2.35, 2.4, 2.6, ITU-R BT.1886, SMPTE ST 2084 (PQ), Hybrid Log-Gamma, Hybrid Log-Gamma RGB, S-Log2 (HDR), S-Log3 (HDR), Gamma LUT 1 to Gamma LUT 8
S-Gamut3 to DCI S-Gamut3.Cine to DCI	Off, 1.0, 2.2, 2.35, 2.4, <u>2.6</u> , ITU-R BT.1886, SMPTE ST 2084 (PQ), S-Log2 (HDR), S-Log3 (HDR), Gamma LUT 1 to Gamma LUT 8	
Gamut LUT 1 to Gamut LUT 8	Off, 1.0, <u>2.2</u> , 2.35, 2.4, 2.6, ITU-R BT.1886, Gamma LUT 1 to Gamma LUT 8	



Item	Setting Options (<u>underline indicates factory default</u>)
HDR Range	<p>Sets the display method when Gamma/EOTF for HDR display is selected.</p> <p>SMPTE ST 2084 (PQ): Sets the "SMPTE ST 2084 (PQ)" dynamic range to be displayed, from 0.005 to 10,000 cd/m² (nits). (100 to 4000: 100 increments. 4000 to 10000: 1000 increments) 100 to 10000 (1000)</p> <p>Hybrid Log-Gamma, Hybrid Log-Gamma RGB: Sets how far to display the "Hybrid Log-Gamma" dynamic range. (in increments of 100) The upper limit value will change to match the settings of "Hybrid Log-Gamma System". (58) Hybrid Log-Gamma: 100 to 1000 Hybrid Log-Gamma RGB: 100 to 1000/2000</p> <p>Canon Log (HDR): Sets the "Canon Log" dynamic range to be displayed, from 0 to 800%. (in 100 increments) 100 to 800</p> <p>Canon Log 2 (HDR): Sets the "Canon Log 2" dynamic range to be displayed, from 0 to 1600%. (in 100 increments) 100 to 1600</p> <p>Canon Log 3 (HDR): Sets the "Canon Log 3" dynamic range to be displayed, from 0 to 1600%. (in 100 increments) 100 to 1600</p> <p>S-Log2 (HDR), S-Log3 (HDR): Sets how far to display the "S-Log" dynamic range. (in 100 increments) S-Log2 (HDR): 100 to 1400 (1000) S-Log3 (HDR): 100 to 3900 (1000)</p> <p>Gamma LUT 1 to Gamma LUT 8: Sets how far to display the 10-bit LUT data dynamic range, from 0 to 1023. (in 1 increments) 512 to 1023</p> <p>❖ Setting procedures The procedures below use Canon Log 2 (HDR) as an example. When the maximum value (1600) is specified, the 1600% dynamic range of Canon Log 2 is assigned to the dynamic range of the video display. Although the brightness in appearance lowers, you can check the dynamic range included in video signals. When "1200" is specified, the part exceeding 1200% of Canon Log 2 is clipped (gradation is saturated) and the part up to 1200% is assigned to the dynamic range of the video display. The brightness of the video display corresponds to the value set for Contrast.</p> <p style="text-align: center;">Canon Log 2 1600% signal (Contrast: "12000")</p> <div style="display: flex; justify-content: space-around;"> <div style="text-align: center;"> <p><u>Canon Log 2 (HDR): Set to "1600"</u></p> <p>Canon Log 2 range</p> <p>Range of video display</p> </div> <div style="text-align: center;"> <p><u>Canon Log 2 (HDR): Set to "1200"</u></p> <p>Canon Log 2 range</p> <p>Range of video display</p> </div> </div> <p style="text-align: center;">Gradation is reproduced by assigning the range to the range of the video display (which lowers the brightness).</p> <p style="text-align: center;">Clip (Saturates gradation.)</p> <p style="text-align: center;">Brightness value corresponding to the contrast setting</p>



Item	Setting Options (underline indicates factory default)
Input Transform	<p>Sets whether or not to apply ACES Input Transform to "3G-SDI RAW" signals (📖 64) when "ACESproxy (ver. 1.0.1)" is selected for "Picture Mode".</p> <p>Automatic: Applied automatically.</p> <p>Off: Not applied.</p>
Output Transform	<p>This is displayed instead of "Gamma/EOTF" and "Color Gamut" when "ACESproxy (ver. 1.0.1)" is selected for "Picture Mode".</p> <p>ITU-R BT.709, ITU-R BT.2020, DCI-P3: ACESproxy is converted into respective mode.</p>
Output Transform Surround	<p>This is displayed instead of "Gamma/EOTF" and "Color Gamut" when "ACESproxy (ver. 1.0.1)" is selected for "Picture Mode".</p> <p>Dim Surround: Enables Dim Surround process specified by ACESproxy.</p> <p>Dark Surround: Enables Dark Surround process specified by ACESproxy.</p>

Item	Setting Options (underline indicates factory default)																																				
Color Range	<p>Sets the quantization range.</p> <p>Automatic: Sets the range based on signal information automatically.</p> <p>When "Color Range" is set to "Normal" (📖104) Full, SDI Full (4-1019), Limited</p> <p>When "Color Range" is set to "Compatible" (📖104) Full (0-1023), SDI Full (4-1019), Limited 1 (64-940), Limited 2 (64-1023)</p> <p> Note</p> <ul style="list-style-type: none"> Setting is disabled when "ACESproxy (ver. 1.0.1)" is selected for "Picture Mode". Operations when "Automatic" is selected are described below. <ul style="list-style-type: none"> It is set in accordance with the settings if Color Range settings are included in the camera metadata. When there is "Full Range" metadata in Payload when SDI is selected, it will be set to "SDI Full". When HDMI is selected, "Full" or "Limited" ("Full (0-1023)" or "Limited 1 (64-940)") is automatically set according to the HDMI signal information. When SDI is selected, the setting is configured according to the settings for Picture Mode, Color Gamut, and Gamma/EOTF. <table border="1" data-bbox="496 837 1449 1491"> <thead> <tr> <th colspan="2" data-bbox="496 837 916 949" rowspan="2">Setting Options</th> <th colspan="2" data-bbox="916 837 1449 875">Color Range to be Set</th> </tr> <tr> <th colspan="2" data-bbox="916 875 1449 949">"System Settings" → "Compatible Settings" → "Color Range"</th> </tr> <tr> <th data-bbox="496 949 663 987"></th> <th data-bbox="663 949 916 987"></th> <th data-bbox="916 949 1166 987">When "Normal"</th> <th data-bbox="1166 949 1449 987">When "Compatible"</th> </tr> </thead> <tbody> <tr> <td data-bbox="496 987 663 1025">Picture Mode</td> <td data-bbox="663 987 916 1025">DCI-P3</td> <td data-bbox="916 987 1166 1025" rowspan="4">Full</td> <td data-bbox="1166 987 1449 1025" rowspan="4">Full (0-1023)</td> </tr> <tr> <td data-bbox="496 1025 663 1064" rowspan="3">Color Gamut</td> <td data-bbox="663 1025 916 1064">DCI-P3</td> </tr> <tr> <td data-bbox="663 1064 916 1102">Cinema Gamut to DCI</td> </tr> <tr> <td data-bbox="663 1102 916 1140">DCI-P3+ to DCI</td> </tr> <tr> <td data-bbox="496 1140 663 1339" rowspan="5">Gamma/EOTF</td> <td data-bbox="663 1140 916 1178">Canon Log (HDR)</td> <td data-bbox="916 1140 1166 1339" rowspan="5">Full</td> <td data-bbox="1166 1140 1449 1339" rowspan="5">Full (0-1023)</td> </tr> <tr> <td data-bbox="663 1178 916 1216">Canon Log 2 (HDR)</td> </tr> <tr> <td data-bbox="663 1216 916 1254">Canon Log 3 (HDR)</td> </tr> <tr> <td data-bbox="663 1254 916 1292">S-Log2 (HDR)</td> </tr> <tr> <td data-bbox="663 1292 916 1339">S-Log3 (HDR)</td> </tr> <tr> <td data-bbox="496 1339 663 1377" rowspan="3">Other than the above</td> <td data-bbox="663 1339 916 1377">Canon Log</td> <td data-bbox="916 1339 1166 1491" rowspan="3">Limited</td> <td data-bbox="1166 1339 1449 1377" rowspan="3">Limited 2 (64-1023)</td> </tr> <tr> <td data-bbox="663 1377 916 1415">Canon Log 2</td> </tr> <tr> <td data-bbox="663 1415 916 1453">Canon Log 3</td> </tr> <tr> <td data-bbox="496 1453 663 1491">Other than the above</td> <td data-bbox="663 1453 916 1491"></td> <td data-bbox="916 1453 1166 1491"></td> <td data-bbox="1166 1453 1449 1491">Limited 1 (64-940)</td> </tr> </tbody> </table> <ul style="list-style-type: none"> Operations when "Format" is set to "ICtCp" are described below. <ul style="list-style-type: none"> When "Color Range" is set to other than "Full", "Wave Form Monitor" will display only a signal set with "Color Range". If "Channel Settings" → "Picture Mode" → "Type" is "L/R", the right screen's "Color Range" setting for the following will be the same as set for the left screen: <ul style="list-style-type: none"> When displaying a single terminal's input in full-screen When displaying "2 Sample Interleave" or "Dual Link 3G-SDI" signals 	Setting Options		Color Range to be Set		"System Settings" → "Compatible Settings" → "Color Range"				When "Normal"	When "Compatible"	Picture Mode	DCI-P3	Full	Full (0-1023)	Color Gamut	DCI-P3	Cinema Gamut to DCI	DCI-P3+ to DCI	Gamma/EOTF	Canon Log (HDR)	Full	Full (0-1023)	Canon Log 2 (HDR)	Canon Log 3 (HDR)	S-Log2 (HDR)	S-Log3 (HDR)	Other than the above	Canon Log	Limited	Limited 2 (64-1023)	Canon Log 2	Canon Log 3	Other than the above			Limited 1 (64-940)
Setting Options				Color Range to be Set																																	
		"System Settings" → "Compatible Settings" → "Color Range"																																			
		When "Normal"	When "Compatible"																																		
Picture Mode	DCI-P3	Full	Full (0-1023)																																		
Color Gamut	DCI-P3																																				
	Cinema Gamut to DCI																																				
	DCI-P3+ to DCI																																				
Gamma/EOTF	Canon Log (HDR)	Full	Full (0-1023)																																		
	Canon Log 2 (HDR)																																				
	Canon Log 3 (HDR)																																				
	S-Log2 (HDR)																																				
	S-Log3 (HDR)																																				
Other than the above	Canon Log	Limited	Limited 2 (64-1023)																																		
	Canon Log 2																																				
	Canon Log 3																																				
Other than the above			Limited 1 (64-940)																																		

Item	Setting Options (underline indicates factory default)
CDL/User LUT	<p>Configures settings for CDL or User LUT.</p> <p>CDL/User LUT: Select a preset such as CDL or external LUT. CDL 1 to CDL 8, User LUT 1 ~ User LUT 8, Off Only when "Picture Mode" is set to "User 1-7" ARRI (Rec2100-PQ-1K-100), ARRI (Rec2100-HLG-1K-200), VARICAM (V-Log to V-709), 2020 PQ to 2020 SDR, 2020 PQ to 709 SDR, 2020 HLG to 709 HLG, 2020 HLG to 709 SDR</p> <p>Power: Adjusts the Gamma of the image. (0.01 increments) 0.50 to 4.00 (1.00)</p> <p>Saturation: Adjusts the color saturation of the image. (0.001 increments) 0.000 to 2.000 (1.000)</p> <p>Offset: Adjusts the black level of the image. (0.001 increments) -1.000 to 1.000 (0.000)</p> <p>Slope: Adjusts the white level of the image. (0.001 increments) 0.000 to 2.000 (1.000)</p> <p>CDL/User LUT Bypass: When "CDL" is selected: When set to "On", you can temporarily disable the CDL adjustment result and return to previously set image quality. When "User LUT" is selected: When set to "On", you can return to the image quality before user LUT was applied. On, Off</p> <p>Detail Settings</p> <p>CDL Export: Exports CDL parameters. CDL Preset (CDL 1 to CDL 15, All), File Type (CCC, CDL), Execute</p> <p>CDL Import: Imports CDL parameters. Filename, CDL Preset (CDL 1 to CDL 8), Execute</p> <p>CDL Preset Name: You can specify the name of preset mode within 16 one-byte characters including alphabetical characters, numbers, and symbols.</p> <p>Anchor CDL: You can temporarily save parameters for "Power", "Saturation", "Offset", and "Slope" and recover the values. (anchor point setting)</p> <p>Reset CDL: Resets CDL parameters.</p>

Item	Setting Options (underline indicates factory default)																							
CDL/User LUT	<p> Note</p> <ul style="list-style-type: none"> When a setting other than "CDL 1-8" is selected, the following functions cannot be set. <ul style="list-style-type: none"> - "Power", "Saturation", "Offset", "Slope", "Detail Settings", "Anchor CDL", "Reset CDL". When "ARRI (Rec2100-PQ-1K-100)" is selected, "HDR Range" → "SMPTE ST 2084 (PQ)" settings become "1000". When "ARRI (Rec2100-HLG-1K-200)" is selected, "HDR Range" → "Hybrid Log-Gamma" settings become "1000". Depending on the "User LUT" settings, "Color Gamut" and "Gamma/EOTF" will be the same as set below. <table border="1" data-bbox="475 524 1449 837"> <thead> <tr> <th>User LUT</th> <th>Color Gamut</th> <th>Gamma/EOTF</th> </tr> </thead> <tbody> <tr> <td>ARRI (Rec2100-PQ-1K-100)</td> <td>ITU-R BT.2020</td> <td>SMPTE ST 2084 (PQ)</td> </tr> <tr> <td>ARRI (Rec2100-HLG-1K-200)</td> <td>ITU-R BT.2020</td> <td>Hybrid Log-Gamma</td> </tr> <tr> <td>VARICAM (V-Log to V-709)</td> <td>ITU-R BT.709</td> <td>2.2</td> </tr> <tr> <td>2020 PQ to 2020 SDR</td> <td>ITU-R BT.2020</td> <td rowspan="2">2.4</td> </tr> <tr> <td>2020 PQ to 709 SDR</td> <td>ITU-R BT.709</td> </tr> <tr> <td>2020 HLG to 709 HLG</td> <td>ITU-R BT.709</td> <td>—</td> </tr> <tr> <td>2020 HLG to 709 SDR</td> <td>ITU-R BT.709</td> <td>2.4</td> </tr> </tbody> </table> <ul style="list-style-type: none"> "CDL/User LUT Bypass": Fixed at "Off" when "Picture Function Settings" → "Compare View" → "Enable" is set to "On". 	User LUT	Color Gamut	Gamma/EOTF	ARRI (Rec2100-PQ-1K-100)	ITU-R BT.2020	SMPTE ST 2084 (PQ)	ARRI (Rec2100-HLG-1K-200)	ITU-R BT.2020	Hybrid Log-Gamma	VARICAM (V-Log to V-709)	ITU-R BT.709	2.2	2020 PQ to 2020 SDR	ITU-R BT.2020	2.4	2020 PQ to 709 SDR	ITU-R BT.709	2020 HLG to 709 HLG	ITU-R BT.709	—	2020 HLG to 709 SDR	ITU-R BT.709	2.4
User LUT	Color Gamut	Gamma/EOTF																						
ARRI (Rec2100-PQ-1K-100)	ITU-R BT.2020	SMPTE ST 2084 (PQ)																						
ARRI (Rec2100-HLG-1K-200)	ITU-R BT.2020	Hybrid Log-Gamma																						
VARICAM (V-Log to V-709)	ITU-R BT.709	2.2																						
2020 PQ to 2020 SDR	ITU-R BT.2020	2.4																						
2020 PQ to 709 SDR	ITU-R BT.709																							
2020 HLG to 709 HLG	ITU-R BT.709	—																						
2020 HLG to 709 SDR	ITU-R BT.709	2.4																						
Detail Settings	Sets details for Picture Mode.																							
Peak Luminance Control	<p>Controls the display luminance according to the brightness of the input image.</p> <p>On, Off</p> <p> Note</p> <ul style="list-style-type: none"> When this is set to "On", the F button assigned with the "Peak Luminance Control" function flashes when display luminance is restricted. It is not possible to set the function after selecting Picture Mode when the right screen is selected. The right screen's setting will be the same as set for the left screen. 																							
LUT Import	<p>You can import LUT. File names that can be imported can be up to 48 one-byte characters, including alphabetical characters, numbers, and symbols (including file extensions).</p> <p>Filename: Select a filename.</p> <p>LUT Type (User LUT, Gamma LUT, Gamut LUT): Select the LUT type.</p> <p>Select LUT: Selects User LUT 1-8/Gamma LUT 1-8/Gamut LUT 1-8.</p> <p>Base Color Gamut (SMPTE-C, EBU, ITU-R BT.709, Adobe RGB, DCI-P3, Native): Selects the color gamut used when creating the LUT (when "Gamut LUT" under "LUT Type" is selected).</p> <p>Execute: Performs import.</p>																							
LUT Name	<p>You can specify the name of LUT within one-byte 24 characters including alphabetical characters, numbers, and symbols.</p> <p>LUT Type (User LUT, Gamma LUT, Gamut LUT): Select the LUT type.</p> <p>Select LUT: Selects User LUT 1-8/Gamma LUT 1-8/Gamut LUT 1-8.</p> <p>Input Name: Input the LUT name.</p>																							
LUT Delete	<p>Deletes imported LUT.</p> <p>LUT Type (User LUT, Gamma LUT, Gamut LUT): Select the LUT type.</p> <p>Select LUT: Selects User LUT 1-8/Gamma LUT 1-8/Gamut LUT 1-8.</p> <p>Delete: Deletes LUT.</p>																							

Item	Setting Options (<u>underline indicates factory default</u>)
YCbCr Color Matrix	<p>Sets the matrix conversion method for input signals in YCbCr format.</p> <p>Automatic: Matrix coefficient is set in conformance with the ITU-R BT.2020 standard when the "Picture Mode" or "Color Gamut" setting is "ITU-R BT.2020" and in conformance with the ITU-R BT.709 standard otherwise.</p> <p>ITU-R BT.709: Matrix coefficient is set in conformance with the ITU-R BT.709 standard.</p> <p>ITU-R BT.2020: Matrix coefficient is set in conformance with the ITU-R BT.2020 standard.</p>
2020 Constant Luminance	<p>Sets the color matrix conversion method to be used when "ITU-R BT.2020" is selected for "Picture Mode" or "Color Gamut".</p> <p>Constant Luminance: YUV signals are linearly converted and then converted into RGB signals.</p> <p>Non-constant Luminance: YUV signals are converted into RGB signals without changing gamma 0.45.</p> <p> Note</p> <ul style="list-style-type: none"> • SD-SDI is fixed to "Non-constant Luminance". • If "Channel Settings" → "Picture Mode" → "Type" is "L/R", "2020 Constant Luminance" is fixed at "Non-constant Luminance" for the following. However, if "Color Gamut" for the left and right screens is "ITU-R BT.2020", then the right screen's setting will be the same as set for the left screen. <ul style="list-style-type: none"> - When displaying a single terminal's input in full-screen - When displaying "2 Sample Interleave" or "Dual Link 3G-SDI" signals
2020 Gamut Mapping	<p>Set this item when "ITU-R BT.2020" is selected for "Picture Mode" or "Color Gamut".</p> <p>Gamut Mapping: Mapping is performed on colors outside the native color gamut by Canon's unique method.</p> <p>Clipping: Colors outside the native color gamut are clipped by a general method.</p>
Hybrid Log-Gamma System	<p>Sets the system gamma or peak luminance when selecting "Hybrid Log-Gamma" or "Hybrid Log-Gamma RGB" in "Gamma/EOTF".</p> <p>Automatic: When "Hybrid Log-Gamma" is selected, it adjusts the system gamma automatically to match the contrast value. It cannot be set when "Hybrid Log-Gamma RGB" is selected.</p> <p>Manual: Operations for when "Hybrid Log-Gamma" or "Hybrid Log-Gamma RGB" is selected are as follows:</p> <p style="padding-left: 20px;">When "Hybrid Log-Gamma" is selected: Adjusts the system gamma. 1.000 to 1.500 (1.200, 0.005 increments)</p> <p style="padding-left: 20px;">When "Hybrid Log-Gamma RGB" is selected: Sets the peak luminance. The maximum value for each setting becomes the upper limit value of "HDR Range". $\gamma 1.2 - 1000 \text{ cd/m}^2$, $\gamma 1.2 - 2000 \text{ cd/m}^2$</p>
HDR/SDR View	<p>The HDR (High Dynamic Range) and SDR (Standard Dynamic Range) displays can be compared.</p> <p>On: The right screen is displayed at SDR luminance.</p> <p>Off: Does not compare the HDR and SDR display.</p> <p> Note</p> <ul style="list-style-type: none"> • This cannot be set when the "Picture Mode" setting for the left and right screens is the same. • When the "Contrast" setting for the left screen is specified as "1000" or less, the luminance of the left and right screens is the same.

Item	Setting Options (underline indicates factory default)															
Calibration	<p>Performs calibration based on set target values when "User 1-7" is selected for "Picture Mode".</p> <p>Luminance: Sets the target luminance. 48 to 500 (100) cd/m²</p> <p>Color Temperature: Sets the target color temperature. D93, D65, D61, D60, D56, D50, DCI-P3: Select from preset color temperatures. Custom (xy): You can adjust CIE x, y in increments of 0.001. x: 0.260 to 0.360 (0.313)/y: 0.260 to 0.360 (0.329)</p> <p>Color Gamut: Sets the color gamut. SMPTE-C, EBU, ITU-R BT.709, ITU-R BT.2020, Adobe RGB, DCI-P3</p> <p>Gamma: Sets the target gamma. 2.2, 2.35, 2.4, 2.6, ITU-R BT.1886</p> <p>Start: Performs calibration.</p> <p> Note</p> <ul style="list-style-type: none"> • When "Luminance" is set to high brightness, it may be calibrated beyond the brightness adjustment range and set lower than the target value, depending on the "Color Temperature" setting. In that case, set the "Luminance" again. • Calibration cannot be executed in "Picture Mode" for the right screen. 															
HDMI Link	<p>When "User 1-7" is selected for "Picture Mode", video is displayed at the image quality linked to the video image quality setting using the HDMI metadata.</p> <p>Automatic Adjustment On, Off</p> <p>Color Gamut/Gamma/EOTF: Matches the "Color Gamut" and "Gamma/EOTF" settings of the video display with the HDMI metadata. On, Off</p> <p>Contrast/HDR Range: Matches the "Contrast" and "HDR Range" setting of the video display with the HDMI metadata. On, Off</p> <p>Backlight Control: Matches the brightness setting of the video display with the HDMI metadata. Peak luminance priority: Operates if "Peak Luminance Control" is "On" even when the average luminance of HDMI metadata is high. Average luminance priority: Operates if "Peak Luminance Control" is "Off" when the average luminance of HDMI metadata is high.</p> <p>Off</p> <p> Note</p> <ul style="list-style-type: none"> • Parameter of HDMI metadata and Video Display <table border="1" data-bbox="475 1429 1461 1662"> <thead> <tr> <th data-bbox="475 1429 810 1464">HDMI metadata</th> <th colspan="2" data-bbox="810 1429 1461 1464">Video display setting</th> </tr> </thead> <tbody> <tr> <td data-bbox="475 1464 810 1500" rowspan="2">Color Gamut</td> <td data-bbox="810 1464 1134 1500">BT.709</td> <td data-bbox="1134 1464 1461 1500">ITU-R BT.709</td> </tr> <tr> <td data-bbox="810 1500 1134 1536">BT.2020</td> <td data-bbox="1134 1500 1461 1536">ITU-R BT.2020</td> </tr> <tr> <td data-bbox="475 1536 810 1572" rowspan="3">Gamma/EOTF</td> <td data-bbox="810 1536 1134 1572">Traditional SDR</td> <td data-bbox="1134 1536 1461 1572">2.2</td> </tr> <tr> <td data-bbox="810 1572 1134 1608">PQ</td> <td data-bbox="1134 1572 1461 1608">PQ</td> </tr> <tr> <td data-bbox="810 1608 1134 1662">Hybrid Log-Gamma</td> <td data-bbox="1134 1608 1461 1662">Hybrid Log-Gamma</td> </tr> </tbody> </table> <ul style="list-style-type: none"> • Cannot set "HDMI Link" when "Channel Settings" → "Picture Mode" → "Type" is "L/R". 	HDMI metadata	Video display setting		Color Gamut	BT.709	ITU-R BT.709	BT.2020	ITU-R BT.2020	Gamma/EOTF	Traditional SDR	2.2	PQ	PQ	Hybrid Log-Gamma	Hybrid Log-Gamma
HDMI metadata	Video display setting															
Color Gamut	BT.709	ITU-R BT.709														
	BT.2020	ITU-R BT.2020														
Gamma/EOTF	Traditional SDR	2.2														
	PQ	PQ														
	Hybrid Log-Gamma	Hybrid Log-Gamma														

Item		Setting Options (underline indicates factory default)
Copy Picture Mode	Copy Picture Mode	<p>When "User 1-7" is selected for "Picture Mode", the content of the selected picture mode is copied. The following modes can be selected: Picture Mode (Copy from): SMPTE-C, EBU, <u>ITU-R BT.709</u>, <u>ITU-R BT.2020</u>, Adobe RGB, DCI-P3, User 1-7 (other than the currently set parameter) Execute: Performs copy.</p> <p> Note</p> <ul style="list-style-type: none"> • In "Picture Mode" other than "User 1-7", the results of calibration performed at the factory are copied.
	Picture Mode Name	You can change the name of "User 1-7" within 24 characters including alphabetical characters, numbers, and symbols.
Anchor Adjustment		<p>Temporarily saves parameters for adjusting "Contrast", "Brightness", "Chroma", "Sharpness", and "HDR Range" and recover the values (anchor point setting). OK: Performs anchor point setting. Cancel: Returns to the previous screen without setting anchor point.</p>
Reset		<p>Return "Picture Mode" to factory default. Note that in "User 1-7" mode where you are performing calibration, the setting returns to the value after calibration instead of the factory default. When selected, the message "Reset Adjustment settings to defaults?" appears. OK: Performs reset. Cancel: Returns to the previous screen without resetting.</p>

The factory default settings for each "Picture Mode" is as follows:

Item	SMPTE-C	EBU	ITU-R BT.709	ITU-R BT.2020	Adobe RGB	DCI-P3	
Contrast	1000	1000	1000	1000	1000	480	
Brightness	0	0	0	0	0	0	
Chroma	1000	1000	1000	1000	1000	1000	
Sharpness	0	0	0	0	0	0	
Backlight Control	Local Dimming Low						
Color Temperature	Preset	D65	D65	D65	D65	DCI-P3	
	x	0.313	0.313	0.313	0.313	0.314	
	y	0.329	0.329	0.329	0.329	0.351	
	Gain R/G/B	1023/1023/1023 (When "D65 Custom" : 1000/1023/1023)					
	Bias R/G/B	0	0	0	0	0	0
Color Gamut	SMPTE-C	EBU	ITU-R BT.709	ITU-R BT.2020	Adobe RGB	DCI-P3	
Gamma/EOTF	2.2	2.35	2.2	2.2	2.2	2.6	
Color Range	Automatic	Automatic	Automatic	Automatic	Automatic	Automatic	
Input Transform	-	-	-	-	-	-	
Output Transform	-	-	-	-	-	-	
Output Transform Surround	-	-	-	-	-	-	
CDL/User LUT	Off	Off	Off	Off	Off	Off	
Peak Luminance Control	Off	Off	Off	Off	Off	Off	
YCbCr Color Matrix	Automatic	Automatic	Automatic	Automatic	Automatic	Automatic	
2020 Constant Luminance	Non-constant Luminance	Non-constant Luminance	Non-constant Luminance	Non-constant Luminance	Non-constant Luminance	Non-constant Luminance	
2020 Gamut Mapping	Clipping	Clipping	Clipping	Clipping	Clipping	Clipping	
Hybrid Log-Gamma System	-		Manual (when "Hybrid Log-Gamma": 1.200; when "Hybrid Log-Gamma RGB": γ 1.2-1000 cd/m ²)		-		
HDR/SDR View	Off	Off	Off	Off	Off	Off	
HDMI Link	Off	Off	Off	Off	Off	Off	
Picture Mode Name	-	-	-	-	-	-	



Item		User 1	User 2	User 3	User 4	User 5-7
Contrast		10000	10000	10000	10000	1000
Brightness		0	0	0	0	0
Chroma		1000	1000	1000	1000	1000
Sharpness		0	0	0	0	0
Backlight Control		Local Dimming Low				
Color Temperature	Preset	D65	D65	DCI-P3	D65	D65
	x	0.313	0.313	0.314	0.313	0.313
	y	0.329	0.329	0.351	0.329	0.329
	Gain R/G/B	1023/1023/1023 (When "D65 Custom" : 1000/1023/1023)				
	Bias R/G/B	0	0	0	0	0
Color Gamut		ITU-R BT.2020	ITU-R BT.2020	DCI-P3	DCI-P3	ITU-R BT.709
Gamma/EOTF		SMPTE ST 2084 (PQ)	Hybrid Log-Gamma	SMPTE ST 2084 (PQ)	SMPTE ST 2084 (PQ)	2.2
Color Range		Automatic	Automatic	Automatic	Automatic	Automatic
Input Transform		-	-	-	-	-
Output Transform		-	-	-	-	-
Output Transform Surround		-	-	-	-	-
CDL/User LUT		Off	Off	Off	Off	Off
Peak Luminance Control		On	On	On	On	Off
YCbCr Color Matrix		Automatic	Automatic	Automatic	Automatic	Automatic
2020 Constant Luminance		Non-constant Luminance	Non-constant Luminance	Non-constant Luminance	Non-constant Luminance	Non-constant Luminance
2020 Gamut Mapping		Clipping	Clipping	Clipping	Clipping	Clipping
Hybrid Log-Gamma System		Manual (when "Hybrid Log-Gamma": 1.200; when "Hybrid Log-Gamma RGB": $\gamma 1.2-1000 \text{ cd/m}^2$)				
HDR/SDR View		On	On	On	Off	Off
HDMI Link		Off	Off	Off	Off	Off
Picture Mode Name		User 1 (2020 PQ)	User 2 (2020 HLG)	User 3 (DCI PQ)	User 4 (DCI PQ D65)	User 5 to User 7

Item		CINEMA EOS SYSTEM	ACESproxy (ver. 1.0.1)
Contrast		10000	480
Brightness		0	0
Chroma		1000	1000
Sharpness		0	0
Backlight Control		Local Dimming Low	
Color Temperature	Preset	D65	D60
	x	0.313	0.322
	y	0.329	0.338
	Gain R/G/B	1023/1023/1023 (When "D65 Custom" : 1000/1023/1023)	
	Bias R/G/B	0	0
Color Gamut		ITU-R BT.2020	-
Gamma/EOTF		Canon Log 2 (HDR)	-
Color Range		Automatic	-
Input Transform		-	Automatic
Output Transform		-	DCI-P3
Output Transform Surround		-	Dark Surround
CDL/User LUT		Off	Off
Peak Luminance Control		On	Off
YCbCr Color Matrix		Automatic	Automatic
2020 Constant Luminance		Non-constant Luminance	Non-constant Luminance
2020 Gamut Mapping		Clipping	Clipping
Hybrid Log-Gamma System		Manual (when "Hybrid Log-Gamma": 1.200; when "Hybrid Log-Gamma RGB": γ 1.2-1000 cd/m ²)	-
HDR/SDR View		Off	Off
HDMI Link		Off	Off
Picture Mode Name		-	-



Channel Settings

This menu is used for input related settings. Select the "Select Channel" and choose a channel number from CH1 to CH30. Finally define the parameter of each of the "Channel Settings".

❖ Supported Signal Format (📖 112)

Item	Setting Options
Select Channel	<p>Display the channel number. In addition, you can assign each content of "Channel Settings" to each channel (📖 33).</p> <p>CH1 to CH30</p> <p> Note</p> <ul style="list-style-type: none"> • It may take 5 seconds when switching channels.
Input Configuration	<p>Select the input. Factory default depend on the channel (📖 69).</p> <p>V2420 3G/HD-SDI, 3G-SDI RAW, SD-SDI, HDMI, – (Not set)</p> <p>V2421 12G-3G/HD-SDI, 3G-SDI RAW, SD-SDI, HDMI, – (Not set)</p>
Select Input Signal	<p>Sets the signal display method (📖 19).</p> <p>Automatic: The display method is automatically determined to match the input signal.</p> <p>Quad Input: Four input signals (Input A to Input D) are displayed.</p> <p>Dual Input A,B: Two input signals (Input A terminal and Input B terminal) are displayed.</p> <p>Dual Input C,D: Two input signals (Input C terminal and Input D terminal) are displayed.</p> <p>Single Input A, Single Input B, Single Input C, Single Input D: One input signal (any of Input A to Input D) is displayed.</p> <p> Note</p> <ul style="list-style-type: none"> • Settings that can be set differ according to the input signal. <ul style="list-style-type: none"> - SD-SDI: Only "Single Input A" to "Single Input D" can be selected. - HDMI: This is fixed to "Automatic".

Item	Setting Options
Image Division	<p>Sets the display method when "Input Configuration" is set to "3G/HD-SDI (V2421 12-3G/HD-SDI)" and "Select Input Signal" is set to "Quad Input" or "Dual Input." Two division methods "Square Division" and "2 Sample Interleave" are supported for 4K video signals.</p> <p>■ "Quad Input"</p> <p>Automatic: Automatically determined based on payload and displayed.</p> <p>Square Division: Displays a signal transmitted over four inputs as a single image.</p> <p>2 Sample Interleave: Displays a signal transmitted divided into a 2K/HD signal as a single image.</p> <p>Multi View (Quad): Displays the video of each of the four inputs in four screens.</p> <p>■ "Dual Input A,B" or "Dual Input C,D"</p> <p>Automatic: Automatically determined based on payload and displayed.</p> <p>Square Division: Displays a signal transmitted over four inputs as a single image.</p> <p>2 Sample Interleave: Displays a signal transmitted divided into a 2K/HD signal as a single image.</p> <p>Dual Link 3G-SDI: Displays a Dual Link 3G-SDI signal as a single image.</p> <p>Multi View (Dual): Displays the video of each of the two inputs (Input A,B or Input C,D) in two screens.</p> <div data-bbox="491 719 1166 887" data-label="Image"> <p>The diagram illustrates the 'Square Division' process. On the left, there are four separate video frames arranged in a 2x2 grid, each showing a different quadrant of a building scene. An arrow points to the right, where a single, larger image is shown, which is a composite of the four quadrants from the previous frames, resulting in a complete square image of the building.</p> </div> <p>Select Input Signal: Quad Input, Image Division: Square Division</p> <p> Note</p> <ul style="list-style-type: none"> V2421 The combinations of video signal formats that can be displayed when using two screens or four screens in "Multi View (Quad)" or "Multi View (Dual)" are as follows: <ul style="list-style-type: none"> - Resolution combinations: Same, or "4096x2160, 2048x1080", "3840x2160, 1920x1080" - When using a frame rate and I/P/PsF combination that is one of "23.98P / 24P / 25P / 29.97P / 30P" "I (All) / PsF (All) / 47.95P / 48P / 50P / 59.94P / 60P" - (Quad screen display only) For both left and right, when the top and bottom screen video signal frame rates and I/P/PsF are the same • There may be periodical deterioration in the image when inputting signals with differing frame rates or I/P/PsF.
Link Order	<p>Automatically detects and displays correct terminal order based on payload when using "2 Sample Interleave" or "Dual Link 3G-SDI".</p> <p>Automatic, Off</p>

Item	Setting Options
Format	<p>Sets the color format and gradation.</p> <ul style="list-style-type: none"> ■ SDI Signal Automatic, 4:2:2 YCbCr 10-bit, 4:2:2 YCbCr 12-bit, 4:4:4 YCbCr 10-bit, 4:4:4 YCbCr 12-bit, 4:2:2 ICtCp 10-bit, 4:2:2 ICtCp 12-bit, 4:4:4 ICtCp 10-bit, 4:4:4 ICtCp 12-bit, 4:4:4 RGB 10-bit, 4:4:4 RGB 12-bit, 4:4:4 XYZ 10-bit, 4:4:4 XYZ 12-bit ■ HDMI Signal Automatic, 4:4:4 XYZ 12/10-bit <p> Note</p> <ul style="list-style-type: none"> • The HD-SDI signal is either "4:2:2 YCbCr 10-bit" or "4:2:2 ICtCp 10-bit". • "SD-SDI" is fixed to "4:2:2 YCbCr 10-bit". • For "3G-SDI RAW", the setting is fixed to "Automatic". • The settings for correctly displaying ICtCp format signals are as follows. <ul style="list-style-type: none"> - "Picture Mode": "ITU-R BT.709" or "ITU-R BT.2020" - "Color Gamut": "ITU-R BT.709" or "ITU-R BT.2020" - "Gamma/EOTF": "SMPTE ST 2084 (PQ)", "Hybrid Log-Gamma" or "Hybrid Log-Gamma RGB" • If you need to use the ICtCp format for SDI signals, select any of the following to match the signal: "4:2:2 ICtCp 10-bit", "4:2:2 ICtCp 12-bit", "4:4:4 ICtCp 10-bit", "4:4:4 ICtCp 12-bit" • If "Automatic" is selected, they are rendered in a Payload that is selected in the order A → B → C → D. • To use 4:4:4 XYZ 10-bit for SDI signals, select "4:4:4 XYZ 10-bit". Then, signals will be processed as signals where XYZ data is included in RGB data output in 4:4:4 RGB 10-bit format.
Audio Input	<p>Sets the audio terminal. Terminals that can be selected differ according to the setting of "Select Input Signal."</p> <p>When "Quad Input": Automatic, Input A, Input B, Input C, Input D</p> <p>When "Dual Input A,B": Automatic, Input A, Input B</p> <p>When "Dual Input C,D": Automatic, Input C, Input D</p> <p>Automatic: Sets automatically to match the input signal.</p> <p> Note</p> <ul style="list-style-type: none"> • This setting is fixed at "Automatic" when "Select Input Signal" is "Automatic" or "Single Input".
Marker/TC/CameraInfo Input	<p>Set the target terminal so that various markers (except Grid Marker), Time Code, and Camera Information are displayed. (Camera Information is available in the "Multi View (Quad)" display only)</p> <p>When "Automatic" or "Quad Input": Input A, Input B, Input C, Input D</p> <p>When "Dual Input A,B": Input A, Input B</p> <p>When "Dual Input C,D": Input C, Input D</p> <p> Note</p> <ul style="list-style-type: none"> • This setting becomes invalid except for the "Multi View (Quad)" or "Multi View (Dual)" display.
Internal Sync	<p>Sets whether to synchronize four inputs when "Square Division" is selected.</p> <p>On: Force synchronization.</p> <p>Off: Do not force synchronization.</p>

Item	Setting Options
Channel Name	Sets the name of the selected channel. You can input up to 16 alphanumeric characters.
Picture Mode	Set "Picture Mode" by individual channel.
Type	<p>Normal: Set one "Picture Mode".</p> <p>Picture Mode</p> <p>L/R: Sets "Picture Mode" by individual left and right screen. Displays as "Single Input Dual View" when using resolutions of 2K or lower.</p> <p>Picture Mode L, Picture Mode R</p> <p>4K/2K: Sets "Picture Mode" by individual 4K or 2K signal screen.</p> <p>Resolution 4K, Resolution 2K</p> <p>Automatic: "Picture Mode" is set according to the SDI signal. The set "Picture Mode" is changed to in the order camera metadata → Payload → resolution (4K/2K).</p> <p>Resolution 4K, Resolution 2K, Payload UHD/PQ, Payload UHD/HLG, Payload UHD, Payload 709/PQ, Payload 709/HLG, Payload 709, Payload VANC, Payload Unknown, Camera CINEMA EOS SYSTEM, Camera ARRI, Camera VARICAM</p> <p> Note</p> <ul style="list-style-type: none"> Settings that can be set differ according to the input signal. <ul style="list-style-type: none"> "SD-SDI": "Type" is fixed to "Normal". "Automatic" cannot be set. "3G-SDI RAW" and "HDMI": "Automatic" and "4K/2K" cannot be set in "Type". When "Type" is "L/R" <ul style="list-style-type: none"> Setting the same "Picture Mode" for both left and right screens will cause "Picture Mode" in the non-selected screen to change to a different mode (for example, the "Picture Mode" settings of the left and right screens are switched). When using a signal 2K or under, it is fixed at "Single Input Dual View".
Picture Mode	Set the "Picture Mode" for each screen.
Picture Mode L	<p>SMPTE-C, EBU, ITU-R BT.709, ITU-R BT.2020, Adobe RGB, DCI-P3, User 1 (2020 PQ), User 2 (2020 HLG), User 3 (DCI PQ), User 4 (DCI PQ D65), User 5 ~ User 7, CINEMA EOS SYSTEM</p> <p>ACESproxy (ver. 1.0.1): Can be set when "Type" is "Normal".</p> <p>— (Not set): Cannot automatically change image quality to suit input signal. Can be set when other than "Resolution 4K" and "Resolution 2K" are selected in "Type" → "Automatic".</p> <ul style="list-style-type: none"> Colorimetry Bit/Transfer Characteristics of the SDI Payload ID supports the signal in conformity with the following standard. <ul style="list-style-type: none"> SMPTE ST 2082-10:2018 (12G-SDI) V2421 SMPTE ST 2081-10:2018 (6G-SDI) V2421 SMPTE ST 425-1:2017 (3G-SDI Single Link / Square Division) SMPTE ST 425-3:2019 (3G-SDI Dual Link(2SI)) SMPTE ST 425-5:2019 (3G-SDI Quad Link(2SI)) SMPTE ST 292-1:2018 (HD-SDI)
Picture Mode R	
Resolution 4K	
Resolution 2K	
Payload UHD/PQ	
Payload UHD/HLG	
Payload UHD	
Payload 709/PQ	
Payload 709/HLG	
Payload 709	
Payload VANC	
Payload Unknown	
Camera CINEMA EOS SYSTEM	
Camera ARRI	
Camera VARICAM	

Item	Setting Options
Single Input Dual View	<p>When other than "Image Division" → "Multi View (Quad)" or "Multi View (Dual)", the image from the input signal can be reduced and shown in dual-screen.</p> <p>Automatic: When "Picture Mode" → "Type" is "L/R", or when the "Picture Function Settings" Sub Menu items are set to "On", identical images are automatically shown and dual-screen comparison can be made. 4K images are shown in reduced size.</p> <p>Relevant "Picture Function Settings" Sub Menu items: "Peaking", "False Color", "Over Range", "2020 Outside of Gamut View", "Monochrome", "Blue Only", "Red Off", "Green Off", "Blue Off", and "Compare View"</p> <p>Off</p> <p> Note</p> <ul style="list-style-type: none"> • Cannot be used when unsupported video signal is input.
Separator	<p>In the following cases, screen borders will be displayed.</p> <ul style="list-style-type: none"> - When "Picture Mode" → "Type" is "L/R" - When "Multi View (Quad)" or "Multi View (Dual)" is selected - When "Single Input Dual View" is set to "Automatic" and the images are shown next to each other for image comparison - When "Picture Function Settings" → "Compare View" → "Enable" is "On" <p>White, Half, Black, Off</p>



The factory default settings for each channel is shown in the following table.



CH		CH1	CH2	CH3	CH4	CH5
Input Configuration	V2420	3G/HD-SDI	HDMI	3G-SDI RAW	3G/HD-SDI	3G/HD-SDI
	V2421	12-3G/HD-SDI	HDMI	3G-SDI RAW	12-3G/HD-SDI	12-3G/HD-SDI
Select Input Signal		Automatic	Automatic	Automatic	Automatic	Automatic
Image Division		Automatic	Automatic	Automatic	Automatic	Automatic
Link Order		Automatic	Automatic	Automatic	Automatic	Automatic
Format		Automatic	Automatic	Automatic	Automatic	Automatic
Audio Input		Automatic	Automatic	Automatic	Automatic	Automatic
Marker/TC/CameraInfo Input		Input A	Input A	Input A	Input A	Input A
Internal Sync		Off	Off	Off	Off	Off
Channel Name		(Blank)	(Blank)	(Blank)	(Blank)	(Blank)
Picture Mode → Type		Normal	Normal	Normal	4K/2K	L/R
Picture Mode Picture Mode L Resolution 4K		ITU-R BT.709	ITU-R BT.709	CINEMA EOS SYSTEM	User 1 (2020 PQ)	User 1 (2020 PQ)
Picture Mode R Resolution 2K		ITU-R BT.709				
Payload	UHD/PQ	User 1 (2020 PQ)				
	UHD/HLG	User 2 (2020 HLG)				
	UHD	ITU-R BT.2020				
	709/PQ	—				
	709/HLG	—				
	709	ITU-R BT.709				
	VANC	—				
	Unknown	—				
Camera	CINEMA EOS SYSTEM	CINEMA EOS SYSTEM				
	ARRI	User 6				
	VARICAM	User 7				
Single Input Dual View		Off	Off	Off	Automatic	Off
Separator		Off	Off	Off	Off	White

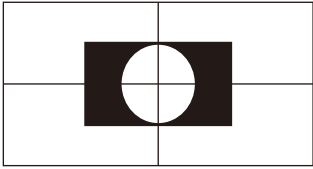
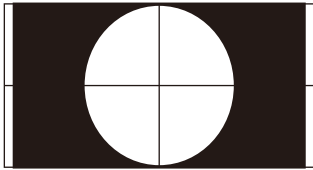
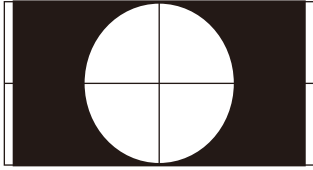

CH	CH6	CH7	CH8	CH9	CH10 to CH30	
Input Configuration	V2420	3G/HD-SDI	3G/HD-SDI	3G/HD-SDI	3G/HD-SDI	— (Not set)
	V2421	12-3G/HD-SDI	12-3G/HD-SDI	12-3G/HD-SDI	12-3G/HD-SDI	— (Not set)
Select Input Signal	Automatic	Automatic	Automatic	Automatic	Automatic	
Image Division	Automatic	Automatic	Automatic	Automatic	Automatic	
Link Order	Automatic	Automatic	Automatic	Automatic	Automatic	
Format	Automatic	Automatic	Automatic	Automatic	Automatic	
Audio Input	Automatic	Automatic	Automatic	Automatic	Automatic	
Marker/TC/CameraInfo Input	Input A	Input A	Input A	Input A	Input A	
Internal Sync	Off	Off	Off	Off	Off	
Channel Name	(Blank)	(Blank)	(Blank)	(Blank)	(Blank)	
Picture Mode → Type	L/R	4K/2K	L/R	L/R	Normal	
Picture Mode Picture Mode L Resolution 4K	User 1 (2020 PQ)	User 2 (2020 HLG)	User 2 (2020 HLG)	User 2 (2020 HLG)	ITU-R BT.709	
Picture Mode R Resolution 2K	ITU-R BT.709					
Payload	UHD/PQ	User 1 (2020 PQ)				
	UHD/HLG	User 2 (2020 HLG)				
	UHD	ITU-R BT.2020				
	709/PQ	—				
	709/HLG	—				
	709	ITU-R BT.709				
	VANC	—				
	Unknown	—				
Camera	CINEMA EOS SYSTEM	CINEMA EOS SYSTEM				
	ARRI	User 6				
	VARICAM	User 7				
Single Input Dual View	Automatic	Automatic	Off	Automatic	Off	
Separator	Off	Off	White	Off	Off	



Display Settings

This menu is used to configure the display method.

Item	Setting Options (<u>underline indicates factory default</u>)
Screen Scaling	<p>Defines how the video is scaled and displayed on the screen.</p> <p>Native Input Resolution: Displays the input signal without scaling.</p>  <p>1920x1080 (original)</p> <p>200%: Doubles the vertical and horizontal dimensions.</p>  <p>1920x1080→3840x2160</p> <p>Automatic: Enlarges to full screen.</p>  <p>1920x1080→3840x2160</p> <p> Note</p> <ul style="list-style-type: none"> • In the following cases, the maximum magnification is 200% even if "Automatic" is selected. <ul style="list-style-type: none"> - When "Peaking", "False Color", or "Over Range" is "On"
Anamorphic	<p>Set when checking images photographed using an anamorphic lens. Displayed in accordance with the set magnification.</p> <p>x2.0, x1.8, x1.5, x1.33, <u>Off</u></p> <p> Note</p> <ul style="list-style-type: none"> • Settings are invalid in the following cases: <ul style="list-style-type: none"> - When "Peaking", "False Color", or "Over Range" is set to "On"

Item	Setting Options (underline indicates factory default)
Scaling Method	<p>Sets the interpolation method when "Screen Scaling" is set to "200%" or "Automatic".</p> <p><u>Shape Trace</u>: Canon original processing that produces smooth slopes with reduced jagged lines.</p>  <p>Bicubic: General interpolation process that uses neighboring pixel information to create interpolated pixels.</p>  <p>Nearest Neighbor: Process that uses nearest neighbor pixel information to create (copy) new pixels. This is useful as it enlarges the original pixels, thus making any jagged lines visible.</p> 
Video Position (Multi View)	<p>When displaying on two or four screens ("Multi View (Quad)" or "Multi View (Dual)" or "Single Input Dual View" display), set the vertical display position for the image.</p> <p>"Top": Displays at the top of the screen.</p> <p>"Middle": Displays at the top middle of the screen.</p> <p>"Center": Displays at the middle of the screen.</p> <p>Top, Middle, Center</p>

Item	Setting Options (underline indicates factory default)
Zoom	<p>Enlarges part of the video image. The zoom function can be used when the resolution is "4096x2160", "3840x2160", "2048x1080" or "1920x1080".</p> <p> Note</p> <ul style="list-style-type: none"> • The zoom function cannot be used in the following cases: <ul style="list-style-type: none"> - During execution of "Playback File" under "Screen Capture" - During display of the test pattern - When calibration has been started - When "Multi View (Quad)" or "Multi View (Dual)" is selected - When "Channel Settings" → "Picture Mode" → "Type" is set to "L/R" - When "Picture Function Settings" → "Compare View" → "Enable" is set to "On" • While the zoom function is in use, the following are not displayed: Background Color, various markers • When zoom settings are changed, "Frame Hold" turns "Off". • When "Type" → "Normal" is selected: When the resolution is "2048x1080" or "1920x1080", the display position cannot be changed even if "Magnification" is set to "x2".
Zoom Preset	<p>Sets the zoom display method. There are three presets. Zoom 1, Zoom 2, Zoom 3, Off</p>
Magnification	<p>Sets the display scale of zoom. x2, x4, x8</p>
Position	<p>The zoom adjustment screen is displayed. Use the jog dial to adjust the display position.</p>
Type	<p>Sets the enlarged image display method. Normal: Only displays the enlarged image. Single Input Dual View: Displays the overall image on the left and the enlarged image on the right.</p> <p> Note</p> <ul style="list-style-type: none"> • When "Type" → "Single Input Dual View" is selected: For 4K video (3840x2160 or 4096x2160), the quality of the enlarged image will be degraded compared to "Normal".

Item	Setting Options (underline indicates factory default)
Frame Hold	<p>Pauses the video.</p> <p>On, <u>Off</u></p> <p> Note</p> <ul style="list-style-type: none"> • Setting is disabled when "Peaking" is set to "On". • If the image quality setting is changed while the video is paused, the setting may not change correctly.
Background Color	<p>Sets the color of the black band to check the boundary of the black band and video image.</p> <p>White, Gray, <u>Off</u></p> <p> Note</p> <ul style="list-style-type: none"> • Setting is disabled when "Multi View (Quad)" or "Multi View (Dual)" is selected.
I/PsF	<p>Defines how the interlace signal or PsF signal is displayed.</p> <p><u>Automatic</u>: Automatically determined based on payload and displayed. If there is no payload, the signal is displayed as an interlace signal.</p> <p>Interlace: Displayed as an interlace signal.</p> <p>PsF: Displayed as a PsF signal.</p>
PsF	<p>Defines how the PsF signal is displayed.</p> <p><u>Progressive</u>: Interpolates giving preference to image quality by detecting paired fields.</p> <p>Interlace: Interpolates using two adjacent fields giving priority to speed.</p>
I/P Conversion	<p>Sets the interlaced signal I/P conversion method.</p> <p><u>Image Priority</u>: This mode gives priority to image quality. Processing time will be longer than "Speed Priority".</p> <p>Speed Priority: This mode gives priority to speed.</p>
Film Cadence	<p>Sets the film cadence mode.</p> <p>2-2: Displays progressive image after conversion for 2-2 pulldown processed interlaced signal input.</p> <p>2-3: Displays progressive image after conversion for 2-3 pulldown processed interlaced signal input.</p> <p>2-3-3-2: Displays progressive image after conversion for 2-3-3-2 pulldown processed interlaced signal input.</p> <p><u>Off</u>: Does not perform film cadence mode progressive conversion.</p> <p> Note</p> <ul style="list-style-type: none"> • This can be set only when "I/P Conversion" is set to "Image Priority". • Cannot be set in the "Multi View (Quad)" or "Multi View (Dual)" display. The setting is fixed to "Off".





Audio Settings



This menu is used to set audio output from the headphone terminal.



Item	Setting Options (underline indicates factory default)
SDI Group	Switches the audio group to be input during SDI audio input. <u>CH1-CH8</u>, CH9-CH16
CH L/R (SDI)	Sets the audio to be output from the two channels (L/R) of the headphone respectively. The options differ according to the "SDI Group" setting. When "CH1-CH8" is selected for "SDI Group": CH1-CH8 When "CH9-CH16" is selected for "SDI Group": CH9-CH16
CH L/R (HDMI)	Sets the audio to be output from the two channels (L/R) of the headphone respectively. CH1-CH8
Volume	Sets the volume. (Increments of 1) 0 to 100 (30)
Audio Switch	Sets the stereo output. L R, L, R, MIX (L+R)



Marker Settings





This menu is used to configure various markers.

Item	Setting Options (underline indicates factory default)
Marker Preset	Customizes markers which are assigned to markers 1 to 5. Marker 1 to 5, Off
Aspect Marker	<p>"Aspect Marker" displays a range in accordance with the specified aspect ratio.</p>  <p> Note "Aspect Marker" is not displayed in the following cases:</p> <ul style="list-style-type: none"> • When there is no signal, unsupported signal, or a channel with "Input Configuration" not set is selected • When an enlarged image is displayed • During the execution of "Playback File" under "Screen Capture" • When a "Test Pattern" is displayed
Enable	Switches the aspect marker On, Off. On, Off
Mask	<p>Switches the mask color. Mask is the blanking area outside the range of the marker.</p> <p>Black:</p>  <p>Half (50% gray):</p>  <p>Off: Turns mask off.</p>
Aspect Ratio	<p>Sets the aspect ratio of the aspect marker.</p> <p>16:9, 15:9, 14:9, 13:9, 4:3, 2.39:1, 2.35:1, 1.896:1, 1.85:1, 1.66:1, Variable</p> <p>The aspect ratio can be entered as a numeric value when you select "Variable" (0.01:1 increments). The grayed out slider becomes active and can be used to set the aspect ratio.</p> <p>1.00:1 to 3.00:1 (1.78:1)</p>
Line	Active when "Black" or "Half" is selected for "Mask". Switches lines on mask On, Off. On, Off
Line Width	Sets the thickness of the aspect marker line. Thick, Normal, Thin

Item	Setting Options (underline indicates factory default)
Line Color	Sets the color of the aspect marker line. White, Red, Green, Blue, Yellow, Cyan, Magenta, Gray
Line Brightness	Sets the brightness of the aspect marker line. High, <u>Low</u>, Half
H Position	Changes horizontal position without changing the aspect. -65 to 65 (0)
V Position	Changes vertical position without changing the aspect. -35 to 35 (0)
Safety Zone Marker 1, 2	<p>There are two types of "Safety Zone Marker": 1 and 2, which share the same settings. A safety zone marker is used to set the safe zone of the image (actual displayed area) to check the image.</p>  <p> Note "Safety Zone Marker" is not displayed in the following cases:</p> <ul style="list-style-type: none"> • When there is no signal, unsupported signal, or a channel with "Input Configuration" not set is selected • When an enlarged image is displayed • During the execution of "Playback File" under "Screen Capture" • When a "Test Pattern" is displayed
Enable	Switches the safety zone marker On, Off. On, <u>Off</u>
Aspect Ratio	Sets the aspect ratio of the safety zone marker. <u>16:9</u>, 15:9, 14:9, 13:9, 4:3, 2.39:1, 2.35:1, 1.896:1, 1.85:1, 1.66:1, Variable The aspect ratio can be entered as a numeric value when you select "Variable" (0.01:1 increments). The grayed out slider becomes active and can be used to set the aspect ratio. 1.00:1 to 3.00:1 (<u>1.78:1</u>)
Area Size	Sets the safety zone marker area size. 80%, 88%, 90%, 93%, Variable (%), Variable (dot) When "Variable (%)" is selected, the grayed out "Rate (%)" becomes active. When "Variable (dot)" is selected, the grayed out "Width (dot)" and "Height (dot)" become active. This can be set by moving the slider.
Rate (%)	Becomes active when you select "Variable (%)" under the menu "Area Size". Move the slider to set the displayed marker area size without changing the aspect ratio in 1 % increments. 50 to 100 (80)
Width (dot)	Becomes active when you select "Variable (dot)" under the menu "Area Size". Move the slider to set the area width in 2 dot increment. 360 to 4096 (3276)
Height (dot)	Becomes active when you select "Variable (dot)" under the menu "Area Size". Move the slider to set the area height in 2 dot increment. 240 to 2160 (<u>1728</u>)



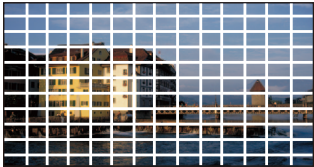

Item	Setting Options (underline indicates factory default)
Shape	<p>Sets the area shape of the safety zone marker.</p> <p>Box:</p>  <p>Brackets:</p>  <p>Enclosure:</p> 
Line Width	<p>Sets the width of the safety zone marker line.</p> <p>Thick, <u>Normal</u>, Thin</p>
Line Color	<p>Sets the color of the safety zone marker line.</p> <p><u>White</u>, Red, Green, Blue, Yellow, Cyan, Magenta, Gray</p>
Line Brightness	<p>Sets the brightness of the safety zone marker line.</p> <p>High, <u>Low</u>, Half</p>
H Position	<p>Adjusts the marker horizontal position with the set aspect and size.</p> <p>-65 to 65 (0)</p>
V Position	<p>Adjusts the marker vertical position with the set aspect and size.</p> <p>-35 to 35 (0)</p>





Item	Setting Options (underline indicates factory default)
Area Marker	<p>"Area Marker" is used to check a specific area using a rectangular box.</p>  <p> Note "Area Marker" is not displayed in the following cases:</p> <ul style="list-style-type: none"> • When there is no signal, unsupported signal, or a channel with "Input Configuration" not set is selected • When an enlarged image is displayed • During the execution of "Playback File" under "Screen Capture" • When a "Test Pattern" is displayed
Enable	Switches the area marker On, Off. On, Off
H Position	Sets the start position (x-coordinate) to draw the rectangle (in increments of 2). 0 to 4086 (240)
V Position	Sets the start position (y-coordinate) to draw the rectangle (in increments of 2). 0 to 2150 (120)
Width (dot)	Sets the width of the rectangle (in increments of 2). 10 to 4096 (240)
Height (dot)	Sets the height of the rectangle (in increments of 2). 10 to 2160 (120)
Mask	Switches the mask color (in the marker). Black, Half, Off
Line	Turns On/Off the outlines of the rectangular box. On, Off
Line Width	Sets the width of the area marker line. Thick, Normal, Thin
Line Color	Sets the color of the area marker line. White, Red, Green, Blue, Yellow, Cyan, Magenta, Gray
Line Brightness	Sets the brightness of the area marker line. High, Low, Half

Item	Setting Options (underline indicates factory default)										
Center Marker	<p data-bbox="395 170 893 197">"Center Marker" shows the center of the image.</p>  <p data-bbox="416 459 507 486"> Note</p> <ul data-bbox="416 506 1174 533" style="list-style-type: none"> • "Center Marker" is not displayed when an enlarged image is displayed. <table border="1" data-bbox="229 539 1482 927"> <tr> <td data-bbox="229 539 384 618">Enable</td> <td data-bbox="384 539 1482 618">Switches the center marker On, Off. On, Off</td> </tr> <tr> <td data-bbox="229 618 384 696">Size</td> <td data-bbox="384 618 1482 696">Sets the size of the center marker. Large, Middle, Small</td> </tr> <tr> <td data-bbox="229 696 384 775">Line Width</td> <td data-bbox="384 696 1482 775">Sets the width of the center marker line. Thick, Normal, Thin</td> </tr> <tr> <td data-bbox="229 775 384 853">Line Color</td> <td data-bbox="384 775 1482 853">Sets the color of the center marker line. White, Red, Green, Blue, Yellow, Cyan, Magenta, Gray</td> </tr> <tr> <td data-bbox="229 853 384 927">Line Brightness</td> <td data-bbox="384 853 1482 927">Sets the brightness of the center marker line. High, Low, Half</td> </tr> </table>	Enable	Switches the center marker On, Off. On, Off	Size	Sets the size of the center marker. Large, Middle, Small	Line Width	Sets the width of the center marker line. Thick, Normal, Thin	Line Color	Sets the color of the center marker line. White, Red, Green, Blue, Yellow, Cyan, Magenta, Gray	Line Brightness	Sets the brightness of the center marker line. High, Low, Half
Enable	Switches the center marker On, Off. On, Off										
Size	Sets the size of the center marker. Large, Middle, Small										
Line Width	Sets the width of the center marker line. Thick, Normal, Thin										
Line Color	Sets the color of the center marker line. White, Red, Green, Blue, Yellow, Cyan, Magenta, Gray										
Line Brightness	Sets the brightness of the center marker line. High, Low, Half										
Grid Marker	<p data-bbox="395 938 1161 965">"Grid Marker" is marker used to check the horizontal and vertical position.</p>  <p data-bbox="416 1211 507 1238"> Note</p> <ul data-bbox="416 1258 1150 1285" style="list-style-type: none"> • "Grid Marker" is not displayed when an enlarged image is displayed. <table border="1" data-bbox="229 1292 1482 1675"> <tr> <td data-bbox="229 1292 384 1370">Enable</td> <td data-bbox="384 1292 1482 1370">Switches the grid marker On, Off. On, Off</td> </tr> <tr> <td data-bbox="229 1370 384 1449">Distance</td> <td data-bbox="384 1370 1482 1449">Sets the horizontal and vertical line distance. 160 dots, 240 dots, 320 dots</td> </tr> <tr> <td data-bbox="229 1449 384 1527">Line Width</td> <td data-bbox="384 1449 1482 1527">Sets the width of the grid marker line. Thick, Normal, Thin</td> </tr> <tr> <td data-bbox="229 1527 384 1606">Line Color</td> <td data-bbox="384 1527 1482 1606">Sets the color of the grid marker line. White, Red, Green, Blue, Yellow, Cyan, Magenta, Gray</td> </tr> <tr> <td data-bbox="229 1606 384 1675">Line Brightness</td> <td data-bbox="384 1606 1482 1675">Sets the brightness of the grid marker line. High, Low, Half</td> </tr> </table>	Enable	Switches the grid marker On, Off. On, Off	Distance	Sets the horizontal and vertical line distance. 160 dots, 240 dots, 320 dots	Line Width	Sets the width of the grid marker line. Thick, Normal, Thin	Line Color	Sets the color of the grid marker line. White, Red, Green, Blue, Yellow, Cyan, Magenta, Gray	Line Brightness	Sets the brightness of the grid marker line. High, Low, Half
Enable	Switches the grid marker On, Off. On, Off										
Distance	Sets the horizontal and vertical line distance. 160 dots, 240 dots, 320 dots										
Line Width	Sets the width of the grid marker line. Thick, Normal, Thin										
Line Color	Sets the color of the grid marker line. White, Red, Green, Blue, Yellow, Cyan, Magenta, Gray										
Line Brightness	Sets the brightness of the grid marker line. High, Low, Half										

Function Settings

This menu is used to set the image signal information display and the cinema camera link function.

Item	Setting Options (underline indicates factory default)
Time Code	<p>Display the time code superimposed on the signal.</p>  <p> Note</p> <ul style="list-style-type: none"> • Settings of the video display that cannot be displayed, or input signal status ( 93) • When "Multi View(Dual)" is displayed, the "H Offset" setting is invalid.
Enable	<p>Switches the time code display On, Off. On, <u>Off</u></p>
Type	<p>Selects the type. <u>VITC</u>, LTC</p> <p> Note</p> <ul style="list-style-type: none"> • This setting becomes invalid when HDMI signal is input and is fixed to "VITC".
Size	<p>Selects the size. Large, <u>Small</u></p>
Position	<p>Selects the display position. Top Left, Top Right, <u>Bottom Left</u>, Bottom Right</p> <p> Note</p> <ul style="list-style-type: none"> • This setting becomes invalid in the "Multi View (Dual)" display.
H Offset	<p>Adjusts the display position of the time code. 0 to 1460 (<u>0</u>)</p>
Type String Display	<p>Sets display of VITC/LTC strings. On, <u>Off</u></p>
Brightness	<p>Sets the Brightness of the strings. <u>Normal</u>, Half</p>

Item	Setting Options (<u>underline indicates factory default</u>)
Audio Level Meter	<p>Configures various settings for the audio level meter. Displays the audio level of the selected channel number.</p> <p>V2421 When using dual or quad screens, setting "Channel Settings" → "Audio Input" to "Automatic" will display multiple audio level meters. You can display up to eight channels on the screen overall.</p> <p> Note</p> <ul style="list-style-type: none"> • Settings of the video display that cannot be displayed, or input signal status ( 93) • V2421 When "Channel Settings" → "Audio input" is set to "Automatic": <ul style="list-style-type: none"> - When displaying as "Multi View (Quad)", "Channel No." becomes "2CH". - When displaying as "Multi View (Dual)", "Channel No." becomes "4CH".
Enable	<p>Switches the audio level meter On, Off.</p> <p>On, <u>Off</u></p>
Channel Number (SDI)	<p>Sets the number of channels displayed when SDI signal is input. Options change according to the setting for "SDI Group" under "Audio Settings".</p> <p>When "CH1-CH8" is selected for "SDI Group": 2CH (CH1-CH2), 4CH (CH1-CH4), 6CH (CH1-CH6), 8CH (CH1-CH8), 8CH (1-4, 5-8) (CH1-CH8)</p> <p>When "CH9-CH16" is selected for "SDI Group": 2CH (CH9-CH10), 4CH (CH9-CH12), 6CH (CH9-CH14), 8CH (CH9-CH16), 8CH (1-4, 5-8) (CH9-CH16)</p> <p> Note</p> <ul style="list-style-type: none"> • When "Channel Number (SDI)" is set to "8CH (1-4, 5-8)", if "Size" is set to "Large", the resulting display will be the same as for "8CH".
Channel Number (HDMI)	<p>Sets the number of channels displayed when HDMI signal is input.</p> <p>2CH (CH1-CH2), 4CH (CH1-CH4), 6CH (CH1-CH6), 8CH (CH1-CH8)</p>
Size	<p>Sets the size of the display.</p> <p>Large, <u>Middle</u>, Small</p>
Peak Hold	<p>When set to "On", one second of audio signal at the peak is kept.</p> <p>On, <u>Off</u></p>
Reference Level	<p>Sets the reference level.</p> <p>-40 to <u>0 (-20)</u></p>
Brightness	<p>Sets brightness for the audio level meter.</p> <p>Normal, <u>Low</u>, Half</p>
Wave Form Monitor	<p>Configures various settings for the wave form monitor. On the wave form monitor, the horizontal axis shows the horizontal resolution of the video and the vertical line shows the signal level. To the right of the wave form monitor, "Color Range" and "HDR Range" information (vertical line) is displayed.</p> <div data-bbox="635 1514 1262 1805" style="text-align: center;"> </div> <p> Note</p> <ul style="list-style-type: none"> • Settings of the video display that cannot be displayed, or input signal status ( 93)
Enable	<p>Switches the wave form monitor On, Off.</p> <p>On, <u>Off</u></p>





Item	Setting Options (underline indicates factory default)
Select Signal	Sets the waveform to be displayed. <u>Y</u>, Cb, Cr, R, G, B
Display Type	Sets the display type. When "Line" is selected, data for one line is displayed. <u>All</u>, Line Selects the line to be displayed when "Line" is selected. Select Line: <u>1</u> to 2160
Scale	Sets the scale of the wave form monitor. <u>Automatic</u> : Sets in accordance with the "Gamma/EOTF" and "Color Range" settings. IRE, ST 2084 (PQ) Full, ST 2084 (PQ) Limited, Hybrid Log-Gamma, Canon Log, Canon Log 2, Canon Log 3, S-Log2, S-Log3, ARRI (Rec2100-PQ-1K-100), ARRI (Rec2100-HLG-1K-200) : Select the scale.
Reference Line	A guide is displayed at the specified position. "Reference Line" is not displayed when "1023" is selected. 4 to <u>1023</u>
Reference Level	Sets the range of the reference level. Tints the outside of the range of the reference level. <ul style="list-style-type: none"> In the case of "Gamma/EOTF" corresponding to the HDR range, parts that exceed the HDR range are tinted. When "Color Range" → "Limited", outside the limited range is tinted. <u>Automatic</u> : Sets in accordance with the "Gamma/EOTF" and "Color Range" settings. Manual : When you select "Manual", sets the reference level. <p>Reference Level High: Sets the reference display level (high). "Reference Level High" is not displayed when "1023" is selected. 468 to 1023</p> <p>Reference Level Low: Sets the reference display level (low). "Reference Level Low" is not displayed when "0" is selected. 0 to 468</p>
Color	Sets the signals to be displayed and the color of signals exceeding the reference level. <u>Y</u>, Cb, Cr, R, G, B : Selects the signal. Selects the color of the selected signal. White, Red, Green, Blue, Yellow, Cyan, Magenta Default value of each signal is shown below. Y (White), Cb (White), Cr (White), R (Red), G (Green), B (Blue) Reference Level High, Reference Level Low : Selects the reference level. White, Red, Green, Blue, Yellow, Cyan, Magenta Default value of each reference level is shown below. Reference Level High (<u>Magenta</u>), Reference Level Low (<u>Cyan</u>)
Brightness	Sets the Brightness of the wave form monitor. <u>Automatic</u> : Brightness is automatically adjusted according to the contrast value and average brightness value of the input signal. Normal, Low
Position	Selects the display position. <u>Bottom Left</u>, Bottom Right  Note <ul style="list-style-type: none"> This setting becomes invalid in the "Multi View (Dual)" display.
Size	Sets the size of the display. Large, <u>Middle</u>, Small



Item	Setting Options (<u>underline indicates factory default</u>)
Vector Scope	<p>Configures various settings for the vector scope. Vector scope displays the intensity of color signals and hue with the horizontal axis showing the color difference signal Cb and the vertical line showing Cr.</p> <div data-bbox="638 268 1197 672" style="text-align: center;"> </div> <p>Note</p> <ul style="list-style-type: none"> Settings of the video display that cannot be displayed, or input signal status (📖 93)
Enable	<p>Switches the vector scope On, Off. On, Off</p>
Target	<p>Sets the target. 75%, 100%, 75%+100%</p>
Position	<p>Selects the display position. Bottom Left, Bottom Right</p> <p>Note</p> <ul style="list-style-type: none"> This setting becomes invalid in the "Multi View (Dual)" display.
Size	<p>Selects the display position. Large, Middle, Small</p>
Histogram	<p>Displays the luminance distribution of the video.</p> <div data-bbox="462 1254 1356 1568" style="text-align: center;"> </div>
Enable	<p>Switches between displaying or hiding "Histogram". On, Off</p>

Item	Setting Options (underline indicates factory default)
Color	<p><u>Automatic</u>: Unless "Picture Function Settings" → "False Color" → "Enable" is set to "Off", it will automatically adjust the display to match the "False Color" settings.</p> <p>Normal: Displays in monochrome.</p> <p>False Color: When "Gamma/EOTF" is set to "SMPTE ST 2084 (PQ)" or "Hybrid Log-Gamma", then it will adjust the display to match the "False Color" settings. When "False Color" → "Enable" is "False Color 1" or "Off": Match the "False Color 1" settings. When "False Color" → "Enable" is "False Color 2": Match the "False Color 2" settings.</p>
Gain	<p>Increases the displayed graph size.</p> <p><u>x1, x2, x3</u></p>
HDR Range	<p>On: Areas that exceed the HDR range will be tinted.</p> <p>On (Clip): Areas that exceed the HDR range and areas that exceed the HDR range and are clipped will be tinted.</p> <p>Off: Areas that exceed the HDR range will not be tinted.</p>
HDR/SDR Ratio	<p>Switches between displaying or not displaying the "HDR/SDR Ratio" when "Gamma/EOTF" is set to "SMPTE ST2084 (PQ)" or "Hybrid Log-Gamma". The ratio calculation for HDR/SDR uses the "False Color" → "HDR/SDR Border" settings.</p> <p><u>On, Off</u></p>
Peak/Ave. Luminance	<p>Switches between displaying or not displaying the "Peak/Ave. Luminance" when "Gamma/EOTF" is set to "SMPTE ST2084 (PQ)" or "Hybrid Log-Gamma".</p> <p><u>On, Off</u></p>
Size	<p>Sets the size of the display.</p> <p><u>Large, Small</u></p> <p> Note</p> <ul style="list-style-type: none"> • Fixed to "Small" during "Single Input Dual View".

Item	Setting Options (<u>underline indicates factory default</u>)
Frame Luminance Monitor	<p>When "Gamma/EOTF" is set to "SMPTE ST 2084 (PQ)" or "Hybrid Log-Gamma", "Max./Ave. Luminance" for the entire screen (frame) is displayed. For other conditions, "Max./Ave. Gradation Values" is displayed. The frame luminance monitor can be used when the resolution is "4096x2160", "3840x2160", "2048x1080" or "1920x1080".</p> <p>Current value for peak luminance (cumulative maximum value)</p> <p>Current value for average luminance (cumulative maximum value)</p> <p>Peak:410(1000) Ave:67(190)</p> <p>Peak luminance</p> <p>Average luminance</p> <ul style="list-style-type: none"> Luminance graph <p>Current value for peak luminance (cumulative maximum value)</p> <p>Current value for average luminance (cumulative maximum value)</p> <p>Peak:280(1000) Ave:30(100)</p> <p>Peak luminance</p> <p>Luminance distribution graph</p> <p>Average luminance</p> <ul style="list-style-type: none"> Ratio graph <p>HDR Ratio</p> <p>SDR Ratio</p> <p> Note</p> <ul style="list-style-type: none"> Settings of the video display that cannot be displayed, or input signal status (93) The update time for "Frame Luminance Monitor" may take a long duration, or graph indication of "Frame Luminance Monitor" may be reset when displaying the "Frame Luminance Monitor" and operating the OSD menu.



Item	Setting Options (<u>underline indicates factory default</u>)
Enable	Sets "Frame Luminance Monitor" on or off. Obtains the luminance value when valid. On, Off
Display	Sets whether each graph is displayed. All: Displays "Luminance Graph (Including luminance value)" and "HDR/SDR Ratio Graph". Luminance Graph: Displays "Luminance Graph". HDR/SDR Ratio Graph: Displays "HDR/SDR Ratio Graph (Including luminance value)". Luminance Value: Displays the peak and average luminance values. Off: Does not display any graphs.
Luminance Graph Settings	Sets "Luminance Graph" display method. Luminance Distribution: Switches between displaying and not displaying the luminance distribution graph. On, Off Color Automatic: Unless "Picture Function Settings" → "False Color" → "Enable" is set to "Off", it will automatically adjust the display to match the "False Color" settings. Normal: Displays in monochrome. False Color: When "Gamma/EOTF" is set to "SMPTE ST 2084 (PQ)" or "Hybrid Log-Gamma", then it will adjust the display to match the "False Color" settings. When "False Color" → "Enable" is "False Color 1" or "Off": Match the "False Color 1" settings. When "False Color" → "Enable" is "False Color 2": Match the "False Color 2" settings. Reference Luminance Level - Peak Automatic: Works in conjunction with the "HDR Range" settings to automatically tint the areas that exceed the peak luminance. Manual: Sets the upper limit for peak luminance. Areas that exceed the set value will be tinted. (400 to 4000: increments of 100, 4000 to 10000: increments of 1000) 400 to 10000 (1000) Reference Luminance Level - Ave.: Areas that exceed the set value will be tinted. (Increments of 100) 100 to 1000 (400) Reference Lum. Rise Level - Peak: Sets the peak luminance rise reference value. (Increments of 10 cd/m ²) 0 to 1000 (400) Reference Lum. Rise Level - Ave.: Sets the average luminance rise reference value. (Increments of 10 cd/m ²) 0 to 1000 (200)
HDR/SDR Ratio Graph Settings	Sets "HDR/SDR Ratio Graph" display method. The ratios for HDR and SDR use the "False Color" → "HDR/SDR Border" settings as well as the settings for each range. Type HDR/SDR: Displays the ratio between the HDR and SDR areas. HDR: Displays the ratio of luminance in the HDR area. Scale: When "Type" is set to "HDR", sets the scale of the luminance value. Automatic, 100%, 75%, 50%, 25%
Size	Sets the size of the display. Large, Small  Note • Fixed to "Small" during "Single Input Dual View".
Reset	Resets the displayed content.
Export	The luminance information obtained when "Frame Luminance Monitor" is valid, is exported to the USB memory.

Item	Setting Options (underline indicates factory default)
Pixel Value Check	<p>When "Gamma/EOTF" is set to "SMPTE ST 2084 (PQ)" or "Hybrid Log-Gamma", the luminance and RGB value of the specified pixel (cursor) position are measured and displayed. The pixel value check can be used when the resolution is "4096x2160", "3840x2160", "2048x1080" or "1920x1080".</p> <p> Note</p> <ul style="list-style-type: none"> • Settings of the video display that cannot be displayed, or input signal status ( 93) • The update time for "Pixel Value Check" may take a long duration when displaying the "Pixel Value Check" and operating the OSD menu.
Enable	<p>Switches the "Pixel Value Check" On, Off. On, Off</p>
H Position	<p>Sets the pixel position (horizontal). 1 to 4096 (960)</p>
V Position	<p>Sets the pixel position (vertical). 1 to 2160 (540)</p>
Reset Position	<p>Sets operation when the RESET button is pressed. Normal: Resets the value to the default value. Around Peak Luminance: Moves closer to the area of peak luminance inside the display image.</p>
Test Pattern	<p>Sets the test pattern built into the main unit. White (1023), White (940), Gray, Black (64), Black (0), Ramp, Color Bars, Color Bars (PQ Full), Color Bars (PQ Limited), Color Bars (HLG), PLUGE, PLUGE (PQ/HLG), Off</p> <p> Note</p> <ul style="list-style-type: none"> • If the power is turned off once and then back on, the test pattern will not be displayed. • The test pattern will be erased in the following cases: <ul style="list-style-type: none"> - When calibration has been started - When a channel is changed using the CH button, F button assigned for Channel UP/ Channel DOWN, or "Select Channel" under "Channel Settings" - When changing "Input Configuration" or "Select Input Signal" under "Channel Settings" - When "Reset All Settings" is executed
Signal Monitoring	<p>Monitors the input signal status.</p> <p> Note</p> <ul style="list-style-type: none"> • "Signal Monitoring" cannot be used in the following cases: <ul style="list-style-type: none"> - When "Single Input Dual View" is displayed - When an enlarged image is displayed - During display of the test pattern - During execution of "Playback File" under "Screen Capture" • When an error is displayed, "In Monitor Display" will not be shown. • The position the error is displayed can be adjusted with "In Monitor Display" → "Position".
Control	<p>Sets whether "Signal Monitoring" is used or not. On, Off</p>
Error Hold	<p>Sets the length of time for displaying errors, when they are detected. On (No time out): Errors continue to be displayed. To hide the displayed error, press the RESET button when closing the OSD menu. On (5 sec.): The displayed error will disappear 5 seconds after the initial detection. Off: Only displays errors during the period when they are detected. The displayed error message will disappear once the error ends.</p>

Item	Setting Options (<u>underline indicates factory default</u>)
No Signal/ Unsupported Signal	Displays an error when there is no signal or the signal is not supported. On, <u>Off</u>
2SI Link Order	Displays an error when the cables inserted into the input terminals are in the wrong order when using signals input via "2 Sample Interleave". On, <u>Off</u>
V2421 SDI CRC Error	Displays an error when an incorrect SDI signal is detected (CRC error). On, <u>Off</u>
V2421 8K 2SI Format	Monitors the input signal status for the four terminals using the SDI signal when "Channel Settings" "Select Input Signal" is set to "Automatic". On, <u>Off</u>
V2421 8K 2SI Switching	When there is no "8K 2SI Format" error, displays while switching video between each terminal (12G-SDI signal only). On, <u>Off</u>  Note <ul style="list-style-type: none"> • Does not operate in the following cases: <ul style="list-style-type: none"> - When "Frame Hold" is "On"
Error Log	Displays error history.
Screen Capture	Captures the screen.
Capture	Captures the screen. The data is saved under the name "YYYYMMDD_hhmmss.bmp" or "YYYYMMDD_hhmmss.jpg" in the root folder of the USB memory.
Frame Hold	Pauses the video. On, <u>Off</u>
Capture Source	Selects the sources to capture. All: Everything is captured including video assistance functions such as markers and wave form monitor as well as OSD menu. Video: Only video signals are captured.
File Type	Sets the File Type of the image to capture. Bitmap, <u>JPEG</u>
Create HDR/SDR Compare File	Creates a file that lets you compare the brightness of HDR and SDR images on a computer. When saving, [_pc] is appended to the file name. On, <u>Off</u>
Playback File	Plays back captured images. Select File: Selects a file. Execute: Plays back the image.  Note <ul style="list-style-type: none"> • When playing back captured images on other DP-V2420/DP-V2421 or PC, color may not be played back precisely. • Cannot replay HDR/SDR comparison images with [_pc] in the file names.
Finish Playback File	Finishes playback.

Item	Setting Options (<u>underline indicates factory default</u>)																																																													
Camera Link Automatic Adjustment (CINEMA EOS)	<p>Sets the functions to link with Cinema EOS cameras and ARRI / Panasonic cinema cameras.</p> <p>Sets whether or not to link to the camera's image quality setting when "CINEMA EOS SYSTEM" is selected for "Picture Mode". (When "Input Configuration" is "3G/HD-SDI (<u>V2421</u> 12-3G/HD-SDI)" or "3G-SDI RAW")</p> <p>On, Off When "Color Gamut/Gamma/EOTF", "Color Temperature", and "Color Range" are all set to "On", the following settings are configured.</p> <p>Parameter of Cinema EOS cameras and video display</p> <table border="1" data-bbox="427 477 1286 1066"> <thead> <tr> <th data-bbox="427 477 730 521">Cinema EOS cameras</th> <th colspan="2" data-bbox="730 477 1286 521">DP-V2420 / DP-V2421</th> </tr> <tr> <th data-bbox="427 521 730 566">Color Space</th> <th data-bbox="730 521 1058 566">Color Gamut</th> <th data-bbox="1058 521 1286 566">Color Temperature</th> </tr> </thead> <tbody> <tr> <td data-bbox="427 566 730 611">BT.709</td> <td data-bbox="730 566 1058 611">ITU-R BT.709</td> <td data-bbox="1058 566 1286 611">D65</td> </tr> <tr> <td data-bbox="427 611 730 656">BT.2020</td> <td data-bbox="730 611 1058 656">ITU-R BT.2020</td> <td data-bbox="1058 611 1286 656">D65</td> </tr> <tr> <td data-bbox="427 656 730 701">DCI-P3</td> <td data-bbox="730 656 1058 701">DCI-P3</td> <td data-bbox="1058 656 1286 701">DCI-P3</td> </tr> <tr> <td data-bbox="427 701 730 790" rowspan="2">DCI-P3+</td> <td data-bbox="730 701 1058 745">DCI-P3+ to 709</td> <td data-bbox="1058 701 1286 745">D65</td> </tr> <tr> <td data-bbox="730 745 1058 790">DCI-P3+ to DCI-P3</td> <td data-bbox="1058 745 1286 790">DCI-P3</td> </tr> <tr> <td data-bbox="427 790 730 925" rowspan="3">Cinema Gamut</td> <td data-bbox="730 790 1058 835">Cinema Gamut to 709</td> <td data-bbox="1058 790 1286 835">D65</td> </tr> <tr> <td data-bbox="730 835 1058 880">Cinema Gamut to 2020</td> <td data-bbox="1058 835 1286 880">D65</td> </tr> <tr> <td data-bbox="730 880 1058 925">Cinema Gamut to DCI-P3</td> <td data-bbox="1058 880 1286 925">DCI-P3</td> </tr> <tr> <td data-bbox="427 925 730 1066" rowspan="3">RAW Gamut</td> <td data-bbox="730 925 1058 969">Cinema Gamut to 709</td> <td data-bbox="1058 925 1286 969">D65</td> </tr> <tr> <td data-bbox="730 969 1058 1014">Cinema Gamut to 2020</td> <td data-bbox="1058 969 1286 1014">D65</td> </tr> <tr> <td data-bbox="730 1014 1058 1066">Cinema Gamut to DCI-P3</td> <td data-bbox="1058 1014 1286 1066">DCI-P3</td> </tr> </tbody> </table> <table border="1" data-bbox="427 1104 1286 1603"> <thead> <tr> <th data-bbox="427 1104 730 1149">Cinema EOS cameras</th> <th colspan="2" data-bbox="730 1104 1286 1149">DP-V2420 / DP-V2421</th> </tr> <tr> <th data-bbox="427 1149 730 1193">Gamma/EOTF</th> <th data-bbox="730 1149 1058 1193">Gamma/EOTF</th> <th data-bbox="1058 1149 1286 1193">HDR Range</th> </tr> </thead> <tbody> <tr> <td data-bbox="427 1193 730 1238">Canon Log</td> <td data-bbox="730 1193 1058 1238">Canon Log (HDR)</td> <td data-bbox="1058 1193 1286 1238">—</td> </tr> <tr> <td data-bbox="427 1238 730 1283">Canon Log 2</td> <td data-bbox="730 1238 1058 1283" rowspan="2">Canon Log 2 (HDR)</td> <td data-bbox="1058 1238 1286 1283" rowspan="2">—</td> </tr> <tr> <td data-bbox="427 1283 730 1328">RAW Gamma</td> </tr> <tr> <td data-bbox="427 1328 730 1373">Canon Log 3</td> <td data-bbox="730 1328 1058 1373">Canon Log 3 (HDR)</td> <td data-bbox="1058 1328 1286 1373">—</td> </tr> <tr> <td data-bbox="427 1373 730 1417">ST 2084, PQ</td> <td data-bbox="730 1373 1058 1417">SMPTE ST 2084 (PQ)</td> <td data-bbox="1058 1373 1286 1417">1000</td> </tr> <tr> <td data-bbox="427 1417 730 1462">Normal (BT.709)</td> <td data-bbox="730 1417 1058 1462" rowspan="3">2.2</td> <td data-bbox="1058 1417 1286 1462">—</td> </tr> <tr> <td data-bbox="427 1462 730 1507">Wide DR</td> </tr> <tr> <td data-bbox="427 1507 730 1552">EOS Std.</td> </tr> <tr> <td data-bbox="427 1552 730 1603">DCI-P3</td> <td data-bbox="730 1552 1058 1603">2.6</td> <td data-bbox="1058 1552 1286 1603">—</td> </tr> </tbody> </table> <p>Color Gamut/Gamma/EOTF: The image quality of the display corresponds to the camera's settings. On, Off</p> <p>Color Temperature: The image quality of the display corresponds to the camera's settings. On, Off</p> <p>Display Color Gamut: Sets the color gamut shown on the display when the camera's "Color Space" is set to "Cinema Gamut" or "DCI-P3+". ITU-R BT.709, ITU-R BT.2020, DCI-P3</p>	Cinema EOS cameras	DP-V2420 / DP-V2421		Color Space	Color Gamut	Color Temperature	BT.709	ITU-R BT.709	D65	BT.2020	ITU-R BT.2020	D65	DCI-P3	DCI-P3	DCI-P3	DCI-P3+	DCI-P3+ to 709	D65	DCI-P3+ to DCI-P3	DCI-P3	Cinema Gamut	Cinema Gamut to 709	D65	Cinema Gamut to 2020	D65	Cinema Gamut to DCI-P3	DCI-P3	RAW Gamut	Cinema Gamut to 709	D65	Cinema Gamut to 2020	D65	Cinema Gamut to DCI-P3	DCI-P3	Cinema EOS cameras	DP-V2420 / DP-V2421		Gamma/EOTF	Gamma/EOTF	HDR Range	Canon Log	Canon Log (HDR)	—	Canon Log 2	Canon Log 2 (HDR)	—	RAW Gamma	Canon Log 3	Canon Log 3 (HDR)	—	ST 2084, PQ	SMPTE ST 2084 (PQ)	1000	Normal (BT.709)	2.2	—	Wide DR	EOS Std.	DCI-P3	2.6	—
Cinema EOS cameras	DP-V2420 / DP-V2421																																																													
Color Space	Color Gamut	Color Temperature																																																												
BT.709	ITU-R BT.709	D65																																																												
BT.2020	ITU-R BT.2020	D65																																																												
DCI-P3	DCI-P3	DCI-P3																																																												
DCI-P3+	DCI-P3+ to 709	D65																																																												
	DCI-P3+ to DCI-P3	DCI-P3																																																												
Cinema Gamut	Cinema Gamut to 709	D65																																																												
	Cinema Gamut to 2020	D65																																																												
	Cinema Gamut to DCI-P3	DCI-P3																																																												
RAW Gamut	Cinema Gamut to 709	D65																																																												
	Cinema Gamut to 2020	D65																																																												
	Cinema Gamut to DCI-P3	DCI-P3																																																												
Cinema EOS cameras	DP-V2420 / DP-V2421																																																													
Gamma/EOTF	Gamma/EOTF	HDR Range																																																												
Canon Log	Canon Log (HDR)	—																																																												
Canon Log 2	Canon Log 2 (HDR)	—																																																												
RAW Gamma																																																														
Canon Log 3	Canon Log 3 (HDR)	—																																																												
ST 2084, PQ	SMPTE ST 2084 (PQ)	1000																																																												
Normal (BT.709)	2.2	—																																																												
Wide DR																																																														
EOS Std.																																																														
DCI-P3	2.6	—																																																												

Item	Setting Options (<u>underline indicates factory default</u>)																																								
Automatic Adjustment (ARRI)	<p>Sets whether or not to link to the camera's image quality setting when "User 6-7" is selected for "Picture Mode". (When "Input Configuration" is "3G/HD-SDI (V2421 12-3G/HD-SDI)")</p> <p>On, Off</p> <p>Parameter of ARRI Cinema camera and video display</p> <table border="1" data-bbox="454 315 1458 824"> <thead> <tr> <th data-bbox="454 315 620 389">ARRI Cinema camera</th> <th colspan="5" data-bbox="620 315 1458 389">DP-V2420 / DP-V2421</th> </tr> <tr> <th data-bbox="454 389 620 465">Color Space</th> <th data-bbox="620 389 810 465">Display Color Gamut</th> <th data-bbox="810 389 1000 465">CDL/ User LUT</th> <th data-bbox="1000 389 1155 465">Color Gamut</th> <th data-bbox="1155 389 1307 465">Gamma/ EOTF</th> <th data-bbox="1307 389 1458 465">HDR Range</th> </tr> </thead> <tbody> <tr> <td data-bbox="454 465 620 542">REC 709</td> <td data-bbox="620 465 810 542">—</td> <td data-bbox="810 465 1000 542">—</td> <td data-bbox="1000 465 1155 542">ITU-R BT.709</td> <td data-bbox="1155 465 1307 542">2.2</td> <td data-bbox="1307 465 1458 542">—</td> </tr> <tr> <td data-bbox="454 542 620 618">REC 2020</td> <td data-bbox="620 542 810 618">—</td> <td data-bbox="810 542 1000 618">—</td> <td data-bbox="1000 542 1155 618">ITU-R BT.2020</td> <td data-bbox="1155 542 1307 618">2.2</td> <td data-bbox="1307 542 1458 618">—</td> </tr> <tr> <td data-bbox="454 618 620 824" rowspan="3">Wide Gamut Log C</td> <td data-bbox="620 618 810 694">Rec2100-PQ-1K-100</td> <td data-bbox="810 618 1000 694">ARRI (Rec2100-PQ-1K-100)</td> <td data-bbox="1000 618 1155 694">ITU-R BT.2020</td> <td data-bbox="1155 618 1307 694">SMPTE ST 2084 (PQ)</td> <td data-bbox="1307 618 1458 694">1000</td> </tr> <tr> <td data-bbox="620 694 810 770">Rec2100-HLG-1K-200</td> <td data-bbox="810 694 1000 770">ARRI (Rec2100-HLG-1K-200)</td> <td data-bbox="1000 694 1155 770">ITU-R BT.2020</td> <td data-bbox="1155 694 1307 770">Hybrid Log-Gamma</td> <td data-bbox="1307 694 1458 770">—</td> </tr> <tr> <td data-bbox="620 770 810 824">User LUT 1-8</td> <td data-bbox="810 770 1000 824">User LUT 1-8</td> <td data-bbox="1000 770 1155 824">—</td> <td data-bbox="1155 770 1307 824">—</td> <td data-bbox="1307 770 1458 824">—</td> </tr> </tbody> </table> <p>User LUT: Sets the color gamut and gamma/EOTF shown on the display when "Automatic Adjustment (ARRI)" is set to "On".</p> <p>Rec2100-PQ-1K-100, Rec2100-HLG-1K-200, User LUT 1-8</p>	ARRI Cinema camera	DP-V2420 / DP-V2421					Color Space	Display Color Gamut	CDL/ User LUT	Color Gamut	Gamma/ EOTF	HDR Range	REC 709	—	—	ITU-R BT.709	2.2	—	REC 2020	—	—	ITU-R BT.2020	2.2	—	Wide Gamut Log C	Rec2100-PQ-1K-100	ARRI (Rec2100-PQ-1K-100)	ITU-R BT.2020	SMPTE ST 2084 (PQ)	1000	Rec2100-HLG-1K-200	ARRI (Rec2100-HLG-1K-200)	ITU-R BT.2020	Hybrid Log-Gamma	—	User LUT 1-8	User LUT 1-8	—	—	—
ARRI Cinema camera	DP-V2420 / DP-V2421																																								
Color Space	Display Color Gamut	CDL/ User LUT	Color Gamut	Gamma/ EOTF	HDR Range																																				
REC 709	—	—	ITU-R BT.709	2.2	—																																				
REC 2020	—	—	ITU-R BT.2020	2.2	—																																				
Wide Gamut Log C	Rec2100-PQ-1K-100	ARRI (Rec2100-PQ-1K-100)	ITU-R BT.2020	SMPTE ST 2084 (PQ)	1000																																				
	Rec2100-HLG-1K-200	ARRI (Rec2100-HLG-1K-200)	ITU-R BT.2020	Hybrid Log-Gamma	—																																				
	User LUT 1-8	User LUT 1-8	—	—	—																																				
Automatic Adjustment (VARICAM)	<p>Sets whether or not to link to the camera's image quality setting when "User 6-7" is selected for "Picture Mode". (When "Input Configuration" is "3G/HD-SDI (V2421 12-3G/HD-SDI)")</p> <p>On, Off</p> <p>Parameter of Panasonic Cinema camera and video display</p> <table border="1" data-bbox="454 1104 1458 1478"> <thead> <tr> <th data-bbox="454 1104 620 1211">Panasonic Cinema camera</th> <th colspan="5" data-bbox="620 1104 1458 1211">DP-V2420 / DP-V2421</th> </tr> <tr> <th data-bbox="454 1211 620 1288">Color Space</th> <th data-bbox="620 1211 810 1288">Display Color Gamut</th> <th data-bbox="810 1211 1000 1288">CDL/ User LUT</th> <th data-bbox="1000 1211 1155 1288">Color Gamut</th> <th data-bbox="1155 1211 1307 1288">Gamma/ EOTF</th> <th data-bbox="1307 1211 1458 1288">HDR Range</th> </tr> </thead> <tbody> <tr> <td data-bbox="454 1288 620 1364">V-709</td> <td data-bbox="620 1288 810 1364">—</td> <td data-bbox="810 1288 1000 1364">—</td> <td data-bbox="1000 1288 1155 1364">ITU-R BT.709</td> <td data-bbox="1155 1288 1307 1364">2.2</td> <td data-bbox="1307 1288 1458 1364">—</td> </tr> <tr> <td data-bbox="454 1364 620 1478" rowspan="2">V-Log</td> <td data-bbox="620 1364 810 1440">V-Log to V-709</td> <td data-bbox="810 1364 1000 1440">VARICAM (V-Log to V-709)</td> <td data-bbox="1000 1364 1155 1440">ITU-R BT.709</td> <td data-bbox="1155 1364 1307 1440">2.2</td> <td data-bbox="1307 1364 1458 1440">—</td> </tr> <tr> <td data-bbox="620 1440 810 1478">User LUT 1-8</td> <td data-bbox="810 1440 1000 1478">User LUT 1-8</td> <td data-bbox="1000 1440 1155 1478">—</td> <td data-bbox="1155 1440 1307 1478">—</td> <td data-bbox="1307 1440 1458 1478">—</td> </tr> </tbody> </table> <p>User LUT: Sets the color gamut and gamma/EOTF shown on the display when "Automatic Adjustment (VARICAM)" is set to "On".</p> <p>V-Log to V-709, User LUT 1-8</p>	Panasonic Cinema camera	DP-V2420 / DP-V2421					Color Space	Display Color Gamut	CDL/ User LUT	Color Gamut	Gamma/ EOTF	HDR Range	V-709	—	—	ITU-R BT.709	2.2	—	V-Log	V-Log to V-709	VARICAM (V-Log to V-709)	ITU-R BT.709	2.2	—	User LUT 1-8	User LUT 1-8	—	—	—											
Panasonic Cinema camera	DP-V2420 / DP-V2421																																								
Color Space	Display Color Gamut	CDL/ User LUT	Color Gamut	Gamma/ EOTF	HDR Range																																				
V-709	—	—	ITU-R BT.709	2.2	—																																				
V-Log	V-Log to V-709	VARICAM (V-Log to V-709)	ITU-R BT.709	2.2	—																																				
	User LUT 1-8	User LUT 1-8	—	—	—																																				

Item	Setting Options (underline indicates factory default)
Anamorphic	<p>When a Canon camera is connected, displays in accordance with the settings when anamorphic lens display settings are included in the camera metadata.</p> <p><u>On</u>, Off</p>
Area Marker	<p>When an ARRI cinema camera is connected to this device, the "H Position", "V Position", "Width", and "Height" for the "Area Marker" change depending on the metadata.</p> <p>ARRI Frame line 1A, ARRI Frame line 1B, <u>Off</u></p> <p> Note</p> <ul style="list-style-type: none"> • This cannot be displayed when "Marker Preset" is "Off".
Fan	<p>Allows you to link stopping the fan to the camera's recording operation (For Cinema EOS cameras, Canon professional-use video cameras, or ARRI cinema cameras that are compatible with this video display). When "Fan Control" under "System Settings" is set to "On", the mode changes so that the fan can be stopped, and when "Fan" is set to "On", the fan can be stopped by linking with the camera's REC signal. At room temperature (25 °C), the fan remains off for approximately one minute. The fan operates at a faster speed than usual before and after the fan is stopped to lower the internal temperature.</p> <p><u>On</u>, Off</p> <p> Note</p> <ul style="list-style-type: none"> • If the temperature inside the main unit increases while the fan is off, the message "Fan will be rotated as the temperature is high." is displayed and the fan starts rotating approximately ten seconds later. Since the temperature of the main unit has increased, the fan rotates faster than usual. • The video display's fan may start rotating earlier than the camera because the temperature inside the main unit has increased. • The fan may not stop in some conditions, for example when used at a high temperature.
Camera Information	<p>Sets conditions to display camera information.</p> <p><u>Automatic</u>: Camera information is displayed for 4 seconds when the information has changed.</p> <p>On: Camera information is always displayed.</p> <p>Off: Camera information is not displayed.</p>





The information display functions that can be displayed vary depending on the video display's settings or the input signal status.



● : Can view — : Cannot view







	Time Code	Audio Level Meter	Wave Form Monitor	Vector Scope	Histo-gram	Frame Luminance Monitor	Pixel Value Check
With an SD-SDI signal	●	●	—	—	—	—	—
While zooming: When "Zoom" → "Type" is set to "Normal"	●	●	—	—	—	—	—
When "Frame Hold" is "On" (For progressive signals)	—	—	●	●	●	●	●
When "Frame Hold" is "On" (For interlaced or PsF signals)	—	—	—	—	●	●	●
When "Peaking" → "Enable" is set to "Peaking 1" or "Peaking 2"	●	●	—	—	●	●	●
During execution of "Playback File" under "Screen Capture"	—	—	—	—	—	—	—
When the display position and "Audio Level Meter" to be displayed is the same	—		●	●	●	●	●
When "Test Pattern" is displayed	—	—	—	—	—	—	—
When "Multi View (Quad)" is displayed	●	●	—	—	—	—	—
When "Multi View (Dual)" is displayed	●	●	●	●	—	—	—
When "Single Input Dual View" is displayed	●	●	●	●	●	●	—
When "Channel Settings" → "Picture Mode" → "Type" is set to "L/R": When "Multi View (Dual)" or "Single Input Dual View" is displayed	●	●	●	●	—	—	—
When "Channel Settings" → "Picture Mode" → "Type" is set to "L/R", and when a single screen is being used	●	●	—	—	—	—	—
When "Picture Function Settings" → "Compare View" → "Enable" is set to "On": When "Single Input Dual View" is set to "Off" and also the resolution is 4096x2160 or 3840x2160	●	●	—	—	—	—	—
When "Wave Form Monitor" is displayed: When "Wave Form Monitor" → "Select Signal" is "R", "G", "B"	●	●	●	—	●	●	●
When "Wave Form Monitor" is displayed and "Wave Form Monitor" → "Size" is "Large": When the "Position" settings for "Wave Form Monitor" and "Vector Scope" are the same, or when using "Multi View (Dual)" / "Single Input Dual View" display	●	●	●	—	●	●	●
When an I/PsF 4K signal is displayed on one screen and when the "Wave Form Monitor" and "Vector Scope" "Position" settings are the same	●	●	●	—	●	●	●
When there is no signal or the input signal is not supported	●	●	●	●	—	—	—
When displaying video at resolutions other than 4096x2160 / 3840x2160 / 2048x1080 / 1920x1080	●	●	●	●	—	—	—

Picture Function Settings

This menu is used to set video assistance functions, for example.

Item	Setting Options (underline indicates factory default)
Peaking	<p>The outline is displayed in a color, used to check the focus. Customizes "Peaking" and sets it to "Peaking 1" or "Peaking 2".</p> <p> Note</p> <ul style="list-style-type: none"> • "Peaking" cannot be displayed during the execution of "Playback File" under "Screen Capture". • Cannot set when "Compare View" → "Enable" is "On".
Enable	<p>Switches the peaking display mode and also sets peaking to Off.</p> <p>Peaking 1, Peaking 2, <u>Off</u></p> <p> Note</p> <ul style="list-style-type: none"> • "Enable" changes to "Off" when the power is turned on again.
Monochrome	<p>Displays video in monochrome.</p> <p>Peaking 1 (<u>On</u>, Off), Peaking 2 (<u>On</u>, Off)</p>
Frequency	<p>Sets the central frequency of contour enhancement signals.</p> <p>Peaking 1 (<u>Low</u>, Middle, High), Peaking 2 (<u>Low</u>, Middle, High)</p>
Range	<p>Sets the width of the range to be colored.</p> <p>-3 ~ 3 (<u>0</u>)</p>
Color	<p>Sets the color to be used.</p> <p>White, <u>Red</u>, Green, Blue, Yellow, Cyan, Magenta</p>
False Color	<p>Displays different colors for the video's brightness levels to make it easier to check the exposure and brightness distribution. Customizes "False Color" and sets it to "False Color 1" or "False Color 2".</p> <p> Note</p> <ul style="list-style-type: none"> • "False Color" cannot be displayed during the execution of "Playback File" under "Screen Capture". • Cannot set when "Compare View" → "Enable" is "On".
Enable	<p>Switches between False Color display mode and non-display.</p> <p>False Color 1, False Color 2, <u>Off</u></p> <p> Note</p> <ul style="list-style-type: none"> • "Enable" changes to "Off" when the power is turned on again.
Type	<p>Sets the tint color display method.</p> <p><u>Automatic</u>: Sets in accordance with the "Gamma/EOTF" settings. IRE, SMPTE ST 2084 (PQ), Hybrid Log-Gamma</p> <p> Note</p> <ul style="list-style-type: none"> • When "IRE" in "Type" is selected, "HDR Range" settings become invalid.
HDR/SDR Border	<p>Sets whether to tint the SDR/HDR areas.</p> <p>100, <u>200</u></p>

Item	Setting Options (<u>underline indicates factory default</u>)
Range - SDR	Sets the upper limit for the SDR area. False Color 1 (On, <u>Off</u>), False Color 2 (On, <u>Off</u>) When "On" is selected, sets the size of the area to be colored. (increments of 10) Monochrome/Brown: 10 to 190 (90*) (40) Brown/Monochrome: 20 to 200 (100*) (80) * When "HDR/SDR Border" is "100"
Range - HDR	Sets the tint color range. False Color 1 (Automatic, Automatic (Over Range), <u>Manual</u>), False Color 2 (<u>Automatic</u>, Automatic (Over Range), Manual) Automatic: Sets the upper limit automatically in accordance with the "Gamma/EOTF" settings. When "Manual" or "Automatic (Over Range)" is selected, sets the size of the area to be colored. SMPTE ST 2084 (PQ): The settings are as follows. (100 to 1000: 10 increments, 1000 to 4000: 100 increments, 4000 to 10000: 1000 increments) Blue/light blue: 250 (150*) to 400 Light blue/green: 400 to 1000 Green/yellow: 600 to 4000 Yellow/orange: 800 to 8000 Orange/red: 1000 to 10000 (Only when using "Manual") Hybrid Log-Gamma: The settings are as follows. (10 increments) Blue/light blue: 250 (150*) to 300 Light blue/green: 300 (200*) to 500 Green/yellow: 400 (300*) to 700 Yellow/orange: 500 (400*) to 900 Orange/red: 600 (500*) to 1000 (Only when using "Manual") * When "HDR/SDR Border" is "100"
Over Range	Displays video in monochrome, with the areas where the set range is exceeded are shown tinted.  Note <ul style="list-style-type: none"> • Cannot set when "Compare View" → "Enable" is "On".
Enable	Switches the "Over Range" On, Off. On, <u>Off</u>  Note <ul style="list-style-type: none"> • "Enable" changes to "Off" when the power is turned on again.
Range (HDR)	Automatic: When "Gamma/EOTF" → "SMPTE ST 2084" or "Hybrid Log-Gamma", only the areas that exceed the "HDR Range" setting are tinted. Manual: Only areas that exceed the range set at "SMPTE ST 2084 (PQ)" or "Hybrid Log-Gamma" are tinted. When you select "Manual", sets the reference level. SMPTE ST 2084 (PQ): Sets the tint color range. (100 to 1000: 10 increments, 1000 to 4000: 100 increments, 4000 to 10000: 1000 increments) 100 to 10000 (1000) Hybrid Log-Gamma: Sets the tint color range. (10 increments) 100 to 1000 (1000)
Range (SDR)	Sets the tint color range. (1 increments) 512 to 1023 (940)

Item	Setting Options (<u>underline indicates factory default</u>)
2020 Outside of Gamut View	When "ITU-R BT.2020" is selected for "Picture Mode" or "Color Gamut", displays video in monochrome, with the areas where the color gamut exceeds the selected color gamut shown in red.  Note <ul style="list-style-type: none"> • Cannot set when "Compare View" → "Enable" is "On".
	Enable Switches between On and Off for "2020 Outside of Gamut View". On, Off  Note <ul style="list-style-type: none"> • "Enable" changes to "Off" when the power is turned on again.
	Color Gamut Sets the "Color Gamut" to be set as out of color gamut. ITU-R BT.709, Native
	Range Sets the range when tinting dark areas. (1 increments) 0 to 512 0: Tints all dark areas. 512: Dark areas at the set values or less are not tinted.
Monochrome	Video is displayed in monochrome. On, Off  Note <ul style="list-style-type: none"> • Cannot set when "Compare View" → "Enable" is "On". • When the power is turned off and on, becomes "Off".
Blue Only	Cuts red and green signals, and displays only blue signals in monochrome. On, Off  Note <ul style="list-style-type: none"> • "Blue Only" cannot be set when "CDL/User LUT" is a setting other than "CDL 1-8" or "Off". • Cannot set when "Compare View" → "Enable" is "On". • When the power is turned off and on, becomes "Off".
Red Off	Video is displayed with red signals cut. On, Off  Note <ul style="list-style-type: none"> • Cannot set when "Compare View" → "Enable" is "On". • When the power is turned off and on, becomes "Off".
Green Off	Video is displayed with green signals cut. On, Off  Note <ul style="list-style-type: none"> • Cannot set when "Compare View" → "Enable" is "On". • When the power is turned off and on, becomes "Off".
Blue Off	Video is displayed with blue signals cut. On, Off  Note <ul style="list-style-type: none"> • Cannot set when "Compare View" → "Enable" is "On". • When the power is turned off and on, becomes "Off".





Item	Setting Options (underline indicates factory default)
Compare View	<p>Images having different image quality settings are displayed on the left and right screens for comparison. (When "Picture Mode" for left and right screens is the same)</p> <p> Note</p> <ul style="list-style-type: none"> • "Compare View" cannot be set in the following cases: <ul style="list-style-type: none"> - When "Channel Settings" → "Picture Mode" → "Type" is "L/R" - When "Peaking", "False Color", "Over Range" or "2020 Outside of Gamut View" → "Enable" → "On" - When "Monochrome", "Blue Only", "Red Off", "Green Off" or "Blue Off" → "On" - For SD-SDI signals • When a signal with a resolution of 2K or smaller is displayed on a single screen, changes to "Single Input Dual View".
Enable	<p>Sets Comparison mode On or Off.</p> <p>On, Off</p>
Type	<p>Sets the type of the image to compare.</p> <p>Automatic: "HDR/SDR" when "Adjustment" → "CDL/User LUT" is "Off", otherwise set at "CDL/User LUT".</p> <p>HDR/SDR: HDR and SDR images are displayed.</p> <p>CDL/User LUT: The image on which "CDL" or "User LUT" is applied is displayed only in the left screen.</p>
HDR/SDR Convert Method	<p>Sets the display method for the screen set in SDR when "Type" is set to "HDR/SDR" or "Automatic ("HDR/SDR" settings)".</p> <p>2020 HDR to 709 SDR, 2020 HDR to 2020 SDR: Setting differs according to the "Gamma/EOTF" settings.</p> <p>"SMPTE ST 2084 (PQ)": The "User LUT" corresponding to each setting is applied.</p> <p>"Hybrid Log-Gamma": The "User LUT" corresponding to each setting is applied.</p> <p>"Canon Log(HDR)", "Canon Log 2(HDR)", "Canon Log 3(HDR)": "Canon Log", "Canon Log 2" or "Canon Log 3" is applied.</p> <p>"S-Log2 (HDR)", "S-Log3 (HDR)": "HDR Range" setting "100" is set.</p> <p>User LUT 1-8: The specified "User LUT" is applied. After applying "User LUT" the adjustment inside the display fixes "Color Gamut" at "ITU-R BT.709" and "Gamma/EOTF" at "2.4".</p> <p>Off: Only brightness is lowered.</p> <p>Adjusts the SDR image quality when "Type" is set to "HDR/SDR" or "Automatic ("HDR/SDR" settings)".</p> <p>Contrast (SDR): Sets the contrast on the SDR side.</p> <p>500 to 2000 (1000)</p> <p>Color Temperature (SDR): Sets the color temperature on the SDR side.</p> <p>Normal, D93, D65, D65 Custom, DCI-P3</p> <p>Gain (SDR): Sets the gain on the SDR side.</p> <p>-15 to 15 (0)</p>

Item		Setting Options (underline indicates factory default)
	User LUT Target 1	Sets the comparison target when "Type" is set to "CDL/User LUT" or "Automatic ("User LUT" settings)". User LUT 1 to User LUT 8, <u>Off</u>
	V2421 User LUT Target 2 (Quad)	Sets the comparison target when "Type" is set to "CDL/User LUT" or "Automatic ("User LUT" settings)". User LUT 1 to User LUT 8, <u>Off</u>
	V2421 User LUT Target 3 (Quad)	User LUT 1-8: Applies the User LUT separately for each quarter screen and displays comparisons when displaying "Multi View (Quad)".

Network/IMD Settings

Make the settings for networking of the main unit and remote operation by external devices.

Item	Setting Options (<u>underline indicates factory default</u>)
LAN	Configures video display's network settings.  Note <ul style="list-style-type: none"> Setting is disabled when "Power on Setting" is set to "User 1-3".
	Configure an IP Address Automatic: Configures an IP address automatically with DHCP/Automatic IP. Manual: Configure an IP address and subnet mask manually.
	Display <u>192.168.0.1</u>
	Subnet Mask <u>255.255.255.0</u>
Wi-Fi	This is used to connect the video display to a network using Wi-Fi and control it from an external control device. (📖36)
	Control Sets the Wi-Fi connection method. Infrastructure: This method connects to Wi-Fi via an access point. Access Point: This device acts as an access point, and this method connects the device directly to the Wi-Fi device. Off: Does not connect to Wi-Fi.
	Infrastructure Sets the access point to connect to. At factory settings, the access point to connect to is not configured. Password: You may specify a password if needed by using up to 24 alpha-numerical characters and symbols. The default password is blank.
Access Point Configures the access point. SSID: Enter the SSID. This can be set using up to 24 alpha-numerical characters and symbols. Frequency: Sets the communication mode. <u>2.4 GHz, 5.0 GHz</u> Channel: Sets the channel to use for communication. When set to "2.4 GHz": 1 to 13 (increments of 1) When set to "5.0 GHz": 36, 40, 44, 48 Password: Enter the password. This is set using between 8 and 24 alpha-numerical characters and symbols. Remember to change the default password. The default password is the serial number. The serial number is the individual 12-digit number assigned to your product, and can be checked on the "System Information" screen.	
Web	Settings for operating this device remotely using a Web browser. (📖38)
	Control Set whether or not to receive control signals from an external device, connected using network connection or Wi-Fi connection, in order to operate the video display remotely from the device's web browser. On, Off
	Password Enter the password. This is set using between 8 and 16 alpha-numerical characters and symbols. The default password is the serial number. The serial number is the individual 12-digit number assigned to your product, and can be checked on the "System Information" screen.

Item	Setting Options (<u>underline indicates factory default</u>)								
Display Setting Link	<p>Settings are linked between displays connected via LAN. This device's setting values are applied to all linked displays.</p> <p>Adjustment, Channel, Adjustment/Channel, Off</p> <p>* Before linking settings, check that the following conditions are met.</p> <p>① Turn on the power to this display and the display(s) to link with, and check that they are all recognized on the network</p> <p>② Change the adjustment or channel and check that the other display(s) also change</p> <p>The devices and firmware versions that can be linked are shown below. DP-V2410: Version 1.4 or higher DP-V2420 / DP-V2421: Version 1.3 or higher DP-V1710 / DP-V1711: Version 1.3 or higher DP-V2411: Version 1.2 or higher Displays not connected can be removed with the RESET button.</p> <p> Note</p> <ul style="list-style-type: none"> • Operating the buttons on this display will reflect setting value changes in all. Linked operations using Payload ID, HDMI, Camera, etc. will not reflect the settings changes. • If a display model has functions with different menu settings or setting ranges, some settings will not be correctly exported (settings will not be changed, will revert to factory defaults, etc.) • In an environment where communication cannot be done properly, such as when the network environment is unstable or the bandwidth is insufficient, settings may not link properly. Only connect displays to be controlled to the LAN. If a Display Controller is connected, it may not operate properly. • Up to 32 displays can have their settings linked. 								
In Monitor Display	<p>The video display supports Television Systems Ltd.'s "TSL UMD Protocol Ver. 5.0". You can operate the video display using an external device connected to the LAN terminal and display characters and tally lights on the screen. You can input any characters you like directly from this video display. (📖 35)</p> <table border="1" data-bbox="220 1104 1481 1700"> <tr> <td data-bbox="220 1104 416 1245">Control</td> <td data-bbox="416 1104 1481 1245"> Sets whether or not to receive the control signal from the connected device. TSL Ver. 5.00, Off Manual: Select to input the characters on this video display. Does not receive a control signal from the connected device. </td> </tr> <tr> <td data-bbox="220 1245 416 1328">Position</td> <td data-bbox="416 1245 1481 1328"> This sets whether the characters and tally lights will be displayed at the top or the bottom. Top, Bottom </td> </tr> <tr> <td data-bbox="220 1328 416 1592">Manual Display Type</td> <td data-bbox="416 1328 1481 1592"> Automatic: Changes display in accordance with the Input Configuration. Single: Single-screen display. Dual A,B, Dual C,D: Dual-screen display. Quad A,B,C,D: Quadruple-screen display.  Note <ul style="list-style-type: none"> • When "Function Settings" → "Signal Monitoring" → "Control" is set to "On" then "Manual Display Type" is fixed to "Automatic". </td> </tr> <tr> <td data-bbox="220 1592 416 1700">Manual String</td> <td data-bbox="416 1592 1481 1700"> Manual String (Single, Dual/Quad A, Dual/Quad B, Dual/Quad C, Dual/Quad D, Single Dual L, Single Dual R): With "Control" set to "Manual", select "Manual String" and set the characters to display. You can input up to 16 alphanumeric characters. </td> </tr> </table>	Control	Sets whether or not to receive the control signal from the connected device. TSL Ver. 5.00, Off Manual: Select to input the characters on this video display. Does not receive a control signal from the connected device.	Position	This sets whether the characters and tally lights will be displayed at the top or the bottom. Top, Bottom	Manual Display Type	Automatic: Changes display in accordance with the Input Configuration. Single: Single-screen display. Dual A,B, Dual C,D: Dual-screen display. Quad A,B,C,D: Quadruple-screen display.  Note <ul style="list-style-type: none"> • When "Function Settings" → "Signal Monitoring" → "Control" is set to "On" then "Manual Display Type" is fixed to "Automatic". 	Manual String	Manual String (Single, Dual/Quad A, Dual/Quad B, Dual/Quad C, Dual/Quad D, Single Dual L, Single Dual R): With "Control" set to "Manual", select "Manual String" and set the characters to display. You can input up to 16 alphanumeric characters.
Control	Sets whether or not to receive the control signal from the connected device. TSL Ver. 5.00, Off Manual: Select to input the characters on this video display. Does not receive a control signal from the connected device.								
Position	This sets whether the characters and tally lights will be displayed at the top or the bottom. Top, Bottom								
Manual Display Type	Automatic: Changes display in accordance with the Input Configuration. Single: Single-screen display. Dual A,B, Dual C,D: Dual-screen display. Quad A,B,C,D: Quadruple-screen display.  Note <ul style="list-style-type: none"> • When "Function Settings" → "Signal Monitoring" → "Control" is set to "On" then "Manual Display Type" is fixed to "Automatic". 								
Manual String	Manual String (Single, Dual/Quad A, Dual/Quad B, Dual/Quad C, Dual/Quad D, Single Dual L, Single Dual R): With "Control" set to "Manual", select "Manual String" and set the characters to display. You can input up to 16 alphanumeric characters.								





System Settings

This menu is used to configure settings related the system of the video display.

Item	Setting Options (underline indicates factory default)
Function/Channel Button	Sets the function or channel to assign to the F buttons or CH button.
Display Function/ Display Function (CDL)	<p>Sets the function to assign to the F buttons of the main unit. Select an F button and assign a function from the following list (📖 106). The factory defaults for the main unit F buttons is as follow:</p> <p>■ Normal mode</p> <p>F1: Picture Mode F2: Brightness F3: TC/ALM F4: WFM/VEC F5: Histogram/Frame Luminance F6: Pixel Value Check F7: Zoom Preset F8: Boost Contrast</p> <p>■ CDL mode</p> <p>F1: CDL/User LUT F2: CDL SOP/SAT F3: CDL/User LUT Bypass F4: Single Input Dual View F5: False Color F6: Over Range F7: 2020 Outside of Gamut View F8: Compare View</p> <p>📝 Note</p> <ul style="list-style-type: none"> • When changing channels with "Channel UP/DOWN", the channels with "Input Configuration" (📖 64) set to "-" are skipped. • When any marker settings are changed using an F button, those changes will be applied to "Enable" under the currently selected "Marker Preset". • "Hide OSD" is a function to hide all OSD. When "On" is selected, OSD, "Background Color" and "Separator" are hidden but the menu can be used.
Display Channel	<p>Sets the channel to assign to the CH button on the display.</p> <p>Select a CH button and register a channel number. A list of settings under the menu "Channel Settings" (📖 64) is displayed.</p>
Language	<p>Sets the language of the OSD menu and messages.</p> <p>English, 日本語, 简体中文</p>
Date/Time	Sets the year/month/date/hour/minute.

Item	Setting Options (underline indicates factory default)										
Display Name	Sets the name of the main unit. You can input up to 16 alphanumeric characters.										
OSD Settings	<table border="1"> <tr> <td data-bbox="245 255 416 551">Banner</td> <td data-bbox="416 255 1482 551"> Sets the banner display method for the channel name, signal information, and status of the video display. Automatic Display: Automatically displays the banner when the input signal or picture mode are changed. <u>On, Off</u> Picture Mode: Sets whether to display "Picture Mode". <u>On, Off</u> Time Out: The banner automatically disappears. <u>On, Off</u> </td> </tr> <tr> <td data-bbox="245 551 416 658">Function Button Guide</td> <td data-bbox="416 551 1482 658"> <u>On:</u> You can display the list of functions assigned to an F button on the video display by pressing the jog dial while OSD is closed. Off: Function Button Guide is not displayed. </td> </tr> <tr> <td data-bbox="245 658 416 734">OSD Position</td> <td data-bbox="416 658 1482 734"> Mode 1 (4096x2160): OSD is displayed in a 4096x2160 area. Mode 2 (3840x2160): OSD is displayed in a 3840x2160 area. </td> </tr> <tr> <td data-bbox="245 734 416 810">OSD Size</td> <td data-bbox="416 734 1482 810"> Sets the size of the OSD menu. <u>Large, Small</u> </td> </tr> <tr> <td data-bbox="245 810 416 954">OSD Brightness</td> <td data-bbox="416 810 1482 954"> Sets the brightness of the OSD. The brightness is automatically adjusted to suit the screen contrast when "Automatic" is selected. You can choose between "High - Low" and "High - Middle" adjustment ranges. Automatic (High - Middle), Automatic (High - Low), High, Middle, Low </td> </tr> </table>	Banner	Sets the banner display method for the channel name, signal information, and status of the video display. Automatic Display: Automatically displays the banner when the input signal or picture mode are changed. <u>On, Off</u> Picture Mode: Sets whether to display "Picture Mode". <u>On, Off</u> Time Out: The banner automatically disappears. <u>On, Off</u>	Function Button Guide	<u>On:</u> You can display the list of functions assigned to an F button on the video display by pressing the jog dial while OSD is closed. Off: Function Button Guide is not displayed.	OSD Position	Mode 1 (4096x2160): OSD is displayed in a 4096x2160 area. Mode 2 (3840x2160): OSD is displayed in a 3840x2160 area.	OSD Size	Sets the size of the OSD menu. <u>Large, Small</u>	OSD Brightness	Sets the brightness of the OSD. The brightness is automatically adjusted to suit the screen contrast when "Automatic" is selected. You can choose between "High - Low" and "High - Middle" adjustment ranges. Automatic (High - Middle), Automatic (High - Low), High, Middle, Low
Banner	Sets the banner display method for the channel name, signal information, and status of the video display. Automatic Display: Automatically displays the banner when the input signal or picture mode are changed. <u>On, Off</u> Picture Mode: Sets whether to display "Picture Mode". <u>On, Off</u> Time Out: The banner automatically disappears. <u>On, Off</u>										
Function Button Guide	<u>On:</u> You can display the list of functions assigned to an F button on the video display by pressing the jog dial while OSD is closed. Off: Function Button Guide is not displayed.										
OSD Position	Mode 1 (4096x2160): OSD is displayed in a 4096x2160 area. Mode 2 (3840x2160): OSD is displayed in a 3840x2160 area.										
OSD Size	Sets the size of the OSD menu. <u>Large, Small</u>										
OSD Brightness	Sets the brightness of the OSD. The brightness is automatically adjusted to suit the screen contrast when "Automatic" is selected. You can choose between "High - Low" and "High - Middle" adjustment ranges. Automatic (High - Middle), Automatic (High - Low), High, Middle, Low										
Protect Settings	<table border="1"> <tr> <td colspan="2" data-bbox="416 954 1482 1030">Locks the settings so they cannot be changed. When you press the MENU button, "Signal/System Information" appears, but other operations are grayed out because they are locked.</td> </tr> <tr> <td data-bbox="245 1030 416 1106">Password</td> <td data-bbox="416 1030 1482 1106">Set a password to protect settings. Use a four-digit number (0000 to 9999). The initial password is blank.</td> </tr> <tr> <td data-bbox="245 1106 416 1348">Protect Target</td> <td data-bbox="416 1106 1482 1348"> You can remove Picture Mode and Select Channel from the items to be protected. Picture Mode: Select "On" to protect or "Off" to exclude settings for "Picture Mode". <u>On, Off</u> Select Channel: Select "On" to protect or "Off" to exclude settings for "Select Channel". <u>On, Off</u> Function Settings: Select "On" to protect or "Off" to exclude settings for "Function Settings". <u>On, Off</u> </td> </tr> <tr> <td data-bbox="245 1348 416 1505">Protect</td> <td data-bbox="416 1348 1482 1505"> Select "OK" to protect. When a password has been set, enter the password and select "OK". <ul style="list-style-type: none"> Unlocking Protect Settings Move the selection frame to "Protect" and press the Jog dial for approximately 3 seconds. When a password has been set, enter the password and select "OK". </td> </tr> </table>	Locks the settings so they cannot be changed. When you press the MENU button, "Signal/System Information" appears, but other operations are grayed out because they are locked.		Password	Set a password to protect settings. Use a four-digit number (0000 to 9999). The initial password is blank.	Protect Target	You can remove Picture Mode and Select Channel from the items to be protected. Picture Mode: Select "On" to protect or "Off" to exclude settings for "Picture Mode". <u>On, Off</u> Select Channel: Select "On" to protect or "Off" to exclude settings for "Select Channel". <u>On, Off</u> Function Settings: Select "On" to protect or "Off" to exclude settings for "Function Settings". <u>On, Off</u>	Protect	Select "OK" to protect. When a password has been set, enter the password and select "OK". <ul style="list-style-type: none"> Unlocking Protect Settings Move the selection frame to "Protect" and press the Jog dial for approximately 3 seconds. When a password has been set, enter the password and select "OK".		
Locks the settings so they cannot be changed. When you press the MENU button, "Signal/System Information" appears, but other operations are grayed out because they are locked.											
Password	Set a password to protect settings. Use a four-digit number (0000 to 9999). The initial password is blank.										
Protect Target	You can remove Picture Mode and Select Channel from the items to be protected. Picture Mode: Select "On" to protect or "Off" to exclude settings for "Picture Mode". <u>On, Off</u> Select Channel: Select "On" to protect or "Off" to exclude settings for "Select Channel". <u>On, Off</u> Function Settings: Select "On" to protect or "Off" to exclude settings for "Function Settings". <u>On, Off</u>										
Protect	Select "OK" to protect. When a password has been set, enter the password and select "OK". <ul style="list-style-type: none"> Unlocking Protect Settings Move the selection frame to "Protect" and press the Jog dial for approximately 3 seconds. When a password has been set, enter the password and select "OK".										

Item	Setting Options (underline indicates factory default)
Power Indicator/Button LED Settings	
Power Indicator Brightness	Adjusts the brightness of the power indicator on the main unit. The greater the number is, the greater the brightness. Off, 1 to 5 (3)
Display Button LED	Sets the F buttons and the lamp on the face. On, Off Off (Luminance Warning On): When "Peak Luminance Control" is set to "On", the F button assigned with this function will flash when display luminance is restricted, while the other F buttons and the lamp on the face will go out.
Button Name Lighting Time (sec.)	Sets the time (sec) until the lamp on the face goes out if no operation is performed. 60, 30, 10, 5
Fan Settings	
Sets the operation of internal fan.	
Fan Control	Fan noise can be eliminated when the main unit is used during shooting or when silent operation is needed. Set this in advance to stop the fan either manually or by linking it with the camera during photography (📖92). When this is set to "On", the mode changes so that the fan can be stopped. On, Off
Fan Stop	If "Fan Stop" is set to "On" and when "Fan Control" is set to "On", the fan can be stopped. At room temperature (25 °C), the fan remains off for approximately one minute. The fan operates at a faster speed than usual before and after the fan is stopped to lower the internal temperature. On, Off <div data-bbox="448 981 539 1014">  Note </div> <ul data-bbox="448 1025 1436 1305" style="list-style-type: none"> • If the message "Invalid operation due to high temperature." is displayed, the fan cannot be stopped even when "On" is selected for this item. Wait until the internal temperature lowers. • If the temperature inside the main unit increases while the fan is off, the message "Fan will be rotated as the temperature is high." is displayed and the fan starts rotating approximately ten seconds later. Since the temperature of the main unit has increased, the fan rotates faster than usual. • Select "Off" to restart the fan. The fan rotates faster than usual. • The fan may not stop in some conditions, for example when used at a high temperature.

Item	Setting Options (<u>underline indicates factory default</u>)										
Compatible Settings <table border="1" data-bbox="220 237 1482 1003" style="width: 100%; border-collapse: collapse;"> <tr> <td data-bbox="220 237 416 409">HDMI</td> <td data-bbox="416 237 1482 409"> Normal: All formats are supported. Compatible 1: Set this option when video is not played correctly in "Normal". HDR signals of a luminance higher than that of the display main unit are not supported. Compatible 2: Set this option when video is not played correctly in "Normal" or "Compatible 1". "4K50.00P/60.00P" and HDR signals are not supported. </td> </tr> <tr> <td data-bbox="220 409 416 517">Color Range</td> <td data-bbox="416 409 1482 517"> Normal: Sets the "Color Range" setting to new types in firmware Version 1.2 or later for this video display. Compatible: Sets the "Color Range" setting to conventional types in firmware Version 1.1 or earlier for this video display. </td> </tr> <tr> <td data-bbox="220 517 416 595">Backlight Control</td> <td data-bbox="416 517 1482 595"> Normal: Increases HDR video visibility compared with the firmware earlier than Version 1.1. Compatible: The displayed image is equivalent to that from firmware earlier than Version 1.1. </td> </tr> <tr> <td data-bbox="220 595 416 736">Reduce Backlight Flash</td> <td data-bbox="416 595 1482 736"> When "Adjustment" → "Backlight Control" is set to an option other than "Off", the screen may exhibit a flash in cases such as switching between scenes with a large difference in luminance. You can use "Reduce Backlight Flash" to reduce this phenomenon. On, Off </td> </tr> <tr> <td data-bbox="220 736 416 1003"> V2421 User LUT </td> <td data-bbox="416 736 1482 1003"> Normal: Information display for videos such as waveform monitors depends on the status following application of User LUT. Compatible: Information display for videos such as waveform monitors depends on the status before application of User LUT  Note <ul style="list-style-type: none"> • When "Picture Function Settings" → "Compare View" → "Enable" is set to "On", fixes as "Normal". </td> </tr> </table>	HDMI	Normal: All formats are supported. Compatible 1: Set this option when video is not played correctly in "Normal". HDR signals of a luminance higher than that of the display main unit are not supported. Compatible 2: Set this option when video is not played correctly in "Normal" or "Compatible 1". "4K50.00P/60.00P" and HDR signals are not supported.	Color Range	Normal: Sets the "Color Range" setting to new types in firmware Version 1.2 or later for this video display. Compatible: Sets the "Color Range" setting to conventional types in firmware Version 1.1 or earlier for this video display.	Backlight Control	Normal: Increases HDR video visibility compared with the firmware earlier than Version 1.1. Compatible: The displayed image is equivalent to that from firmware earlier than Version 1.1.	Reduce Backlight Flash	When "Adjustment" → "Backlight Control" is set to an option other than "Off", the screen may exhibit a flash in cases such as switching between scenes with a large difference in luminance. You can use "Reduce Backlight Flash" to reduce this phenomenon. On, Off	V2421 User LUT	Normal: Information display for videos such as waveform monitors depends on the status following application of User LUT. Compatible: Information display for videos such as waveform monitors depends on the status before application of User LUT  Note <ul style="list-style-type: none"> • When "Picture Function Settings" → "Compare View" → "Enable" is set to "On", fixes as "Normal". 	Sets compatibility with HDMI devices and operation of functions that differ according to the version of the video display's firmware.
HDMI	Normal: All formats are supported. Compatible 1: Set this option when video is not played correctly in "Normal". HDR signals of a luminance higher than that of the display main unit are not supported. Compatible 2: Set this option when video is not played correctly in "Normal" or "Compatible 1". "4K50.00P/60.00P" and HDR signals are not supported.										
Color Range	Normal: Sets the "Color Range" setting to new types in firmware Version 1.2 or later for this video display. Compatible: Sets the "Color Range" setting to conventional types in firmware Version 1.1 or earlier for this video display.										
Backlight Control	Normal: Increases HDR video visibility compared with the firmware earlier than Version 1.1. Compatible: The displayed image is equivalent to that from firmware earlier than Version 1.1.										
Reduce Backlight Flash	When "Adjustment" → "Backlight Control" is set to an option other than "Off", the screen may exhibit a flash in cases such as switching between scenes with a large difference in luminance. You can use "Reduce Backlight Flash" to reduce this phenomenon. On, Off										
V2421 User LUT	Normal: Information display for videos such as waveform monitors depends on the status following application of User LUT. Compatible: Information display for videos such as waveform monitors depends on the status before application of User LUT  Note <ul style="list-style-type: none"> • When "Picture Function Settings" → "Compare View" → "Enable" is set to "On", fixes as "Normal". 										
Firmware/License Update	This function is used to update the video display firmware. Refer to the Canon website for detailed information.										
Export/Import	Sets the export/import main menu settings.  Note <ul style="list-style-type: none"> • The following settings cannot be exported or imported. <table border="1" data-bbox="475 1238 1460 1536" style="width: 100%; border-collapse: collapse;"> <tr> <td style="width: 30%;">Adjustment</td> <td>Target values of Calibration (including calibration results)</td> </tr> <tr> <td>Display Settings</td> <td>Zoom Preset, Frame Hold</td> </tr> <tr> <td>Picture Function Settings</td> <td>Peaking (Enable), False Color (Enable), Over Range (Enable), 2020 Outside of Gamut View (Enable), Test Pattern, Monochrome, Blue Only, Red Off, Green Off, Blue Off, Compare View (Enable)</td> </tr> <tr> <td>Network/IMD Settings</td> <td>LAN, Wi-Fi, Display Setting Link (LAN and Wi-Fi: only export/import via network)</td> </tr> <tr> <td>System Settings</td> <td>Date/Time, Fan Stop, Export/Import, Power on Setting</td> </tr> </table> <ul style="list-style-type: none"> • User LUT data cannot be exported or imported to "User 1-3" under "Target". • Data exported from this product may not be imported to products of which firmware version is earlier than the version of this product. To import data, update the firmware to the latest version. 	Adjustment	Target values of Calibration (including calibration results)	Display Settings	Zoom Preset, Frame Hold	Picture Function Settings	Peaking (Enable), False Color (Enable), Over Range (Enable), 2020 Outside of Gamut View (Enable), Test Pattern, Monochrome, Blue Only, Red Off, Green Off, Blue Off, Compare View (Enable)	Network/IMD Settings	LAN, Wi-Fi, Display Setting Link (LAN and Wi-Fi: only export/import via network)	System Settings	Date/Time, Fan Stop, Export/Import, Power on Setting
Adjustment	Target values of Calibration (including calibration results)										
Display Settings	Zoom Preset, Frame Hold										
Picture Function Settings	Peaking (Enable), False Color (Enable), Over Range (Enable), 2020 Outside of Gamut View (Enable), Test Pattern, Monochrome, Blue Only, Red Off, Green Off, Blue Off, Compare View (Enable)										
Network/IMD Settings	LAN, Wi-Fi, Display Setting Link (LAN and Wi-Fi: only export/import via network)										
System Settings	Date/Time, Fan Stop, Export/Import, Power on Setting										

Item	Setting Options (underline indicates factory default)
Export	<p>Target: Select the export destination.</p> <p><u>USB</u>: Export to a USB memory.</p> <p>User 1-3: Export to the built-in memory of the main unit.</p> <p>LAN: Exports to a display connected with a LAN.</p> <p>Filename: Changes the file name when "Target" is set to "USB" or "User 1-3". Factory default is "dinfo_dpv2420.dat (V2421 dinfo_dpv2421.dat)". You can change the name of the file to be exported to the USB memory within 16 one-byte characters including alphabetical characters, numbers, and symbols.</p> <p>Display: Selects the display with the settings to export from the displays connected via LAN when "Target" is set to "LAN".</p> <p>Execute: Performs export.</p>
Import	<p>Target: Specify the destination to save the file to be imported.</p> <p><u>USB, User 1-3</u></p> <p>Filename: Displays files with the extension ".dat" so you can select from among them.</p> <p>Settings (All, Adjustment, Channel Settings, Display Settings, Audio Settings, Marker Settings, Function/Network/System Settings): Select the settings to import.</p> <p>Execute: Performs import.</p>
Power on Setting	<p>You can select the state of the display when the power is turned on.</p> <p><u>Last memory</u>: Launches with the same settings as when the power was turned off the previous time.</p> <p>User 1-3: It starts up with the settings saved in "User 1-3" under "Export".</p>
Reset All Settings	<p>Returns all settings to factory default. When selected, the message "Reset all settings to factory defaults?" appears.</p> <p>OK: Performs reset.</p> <p>Cancel: Returns to the previous screen without resetting.</p>

The following functions can also be assigned to an F button (📄101).

Item	Options
Adjustment	Picture Mode
	Contrast
	Brightness
	Chroma
	Chroma Up
	Sharpness
	Backlight Control
	Gamma/EOTF
	HDR
	HDR Range
	Peak Luminance Control
	HDR/SDR View
	Gain
	Bias
	xy
	Picture Mode
EBU	
ITU-R BT.709	
ITU-R BT.2020	
Adobe RGB	
DCI-P3	
User 1 (2020 PQ)	
User 2 (2020 HLG)	
User 3 (DCI PQ)	
User 4 (DCI PQ D65)	
User 5 ~ User 7	
CINEMA EOS SYSTEM	
ACESproxy (ver. 1.0.1)	
CDL/User LUT	CDL /User LUT
	CDL RGB
	CDL R
	CDL G
	CDL B
	CDL SOP/SAT
	CDL Slope
	CDL Offset
	CDL Power
	CDL Saturation
	CDL/User LUT Bypass
	CDL Export/Import

Item	Options
Channel Settings	Channel UP
	Channel DOWN
	Select Input Signal
	Audio Input
	Single Input Dual View
	CH1 to CH20
	Display Settings
Anamorphic	
Scaling Method	
Zoom Preset	
Zoom 1	
Zoom 2	
Zoom 3	
Frame Hold	
Background Color	
Audio Settings	SDI Group
	CH L
	CH R
	Volume
	Audio Switch
Marker Settings	Marker Preset
	Marker 1
	Marker 2
	Marker 3
	Marker 4
	Marker 5
	Aspect Marker
	Safety Zone Marker 1
	Safety Zone Marker 2
	Area Marker
	Center Marker
Grid Marker	

Item	Options
Function Settings	TC/ALM
	Time Code
	Audio Level Meter
	WFM/VEC
	Wave Form Monitor
	WFM Select Signal
	Vector Scope
	Histogram/Frame Luminance
	Histogram
	Frame Luminance Monitor
	Pixel Value Check
	Signal Monitoring Log
	Capture
	Camera Information
Picture Function Settings	Peaking
	Peaking 1
	Peaking 2
	False Color
	False Color 1
	False Color 2
	Over Range
	2020 Outside of Gamut View
	Monochrome
	Blue Only
	Red Off
	Green Off
	Blue Off
	Compare View
System Settings	Signal Information
	Hide OSD
	Fan Stop

Signal Information

Shows the signal information. When "Select Input Signal" is "Quad Input", information for the entire signal and each input is displayed. Select a signal with the jog dial according to the guide at top right corner of the menu. When signal information has been obtained although it is not displayed on the screen, the content of the information is grayed out.

SDI Signal		HDMI Signal	
Item	Display Example	Item	Display Example
Channel	CH1	Channel	CH4
Input Configuration	3G/HD-SDI (3G-A)	Input Configuration	HDMI
Select Input Signal	Quad Input	Format	Automatic
Image Division	Automatic	Resolution	4096x2160
Format	Automatic	Picture Rate, I/P/PsF	60.00P
Resolution	4096x2160	Pixel Encoding, Color Depth	4:2:2 YCbCr 10-bit
Picture Rate, I/P/PsF*	24.00P	Matrix	ITU-R BT.709
SDI Payload ID	89 C3 46 01	Range	Full
Video Standard	3G-SDI	EOTF	SMPTE ST 2084 (PQ)
Sampling Structure, Bit Depth	4:4:4:4 GBRA 10-bit	Max Luminance (Peak/Avg.)	1000 / 500 cd/m ²
Picture Rate	24.00	Display Luminance (Max/Min)	1000 - 0.005 cd/m ²
Scanning Method	Progressive/Progressive (Transport/Picture)	White Point	x=0.313, y=0.329
Link Number	Single/Link_1	Primary Color Red	x=0.640, y=0.330
Colorimetry	UHD	Primary Color Green	x=0.300, y=0.600
Transfer Characteristics	SDR-TV	Primary Color Blue	x=0.150, y=0.060

* When a content is grayed out, an asterisk "*" may be displayed indicating low "Picture Rate" accuracy such as "24.00P *".

System Information

Shows the video display status and network information.

Item	Display Example
Display	DP-V2420
Serial No.	000000000000
Firmware/License Ver.	1.3
Usage Time*	5 h
IP Address	192.168.0.1
Subnet Mask	255.255.255.0
MAC Address	FF:FF:FF:FF:FF:FF
Wi-Fi IP Address	192.168.0.1
Wi-Fi Subnet Mask	255.255.255.0

* The "Usage Time" is not always "0" when you purchase the display due to factory inspection.

Main specifications/Performance

Panel		
Panel Type	IPS LCD panel	
Screen Size	24 inch (61.1 cm)	
Aspect Ratio	17:9	
Resolution	4096x2160 (8.8 megapixels)	
Active Display Area	Approximately 540.7 x 285.1 mm	
Pixel Pitch	132 µm/193 ppi	
Panel Driver	1024 gradations, 10-bit for each RGB color	
Image quality		
Brightness (Standard)	100 cd/m ²	
View Angle (Up, Down, Left, Right)	89° (contrast ratio 10 : 1 or higher)	
Surface Treatment	Anti-glare coating	
General		
Backlight Type	RGB LED, direct down type	
Power	Rated Voltage: 100 – 240 V AC Rated Frequency: 50/60 Hz	
Power consumption	At maximum load (including change in brightness through aging): Approximately 510 W At factory shipment: Approximately 180 W	
Environmental Conditions	Operating	Temperature and humidity: 0 – 40 °C (32 – 104 °F), 20 – 85 %RH (no condensation) recommended: 15 – 30 °C (59 – 86 °F) Pressure: 700 – 1060 hPa
	Storage/Transporting	Temperature and humidity: -20 – 40 °C (-4 – 104 °F), 20 – 85 %RH (no condensation) 41 – 60 °C (105 – 140 °F), 20 – 30 %RH (no condensation) Pressure: 700 – 1060 hPa
Dimensions (width x height x depth)	Including stands: Approx. 594×399×235 mm (23.4×15.7×9.3 in.) Main unit only, excluding protrusions: Approx. 594×378×195 mm (23.4×14.9×7.7 in.)	
Weight	Approximately 19 kg (41.8 lb)	
Mounting Hole Pitch	VESA standard 200 x 100 mm (7.9 x 3.9 in.)	

Interface		
Input	V2420 3G/HD/SD-SDI V2421 12G/6G/3G/HD/SD-SDI	4 (1 systems) BNC (75Ω) receptacle terminal V2421 12G-SDI: Compliant with SMPTE 2082 V2421 6G-SDI: Compliant with SMPTE 2081 3G-SDI: Compliant with SMPTE 2048-2/274M/296/372/425-5/425-3/425-1/428-19/428-9 HD-SDI: Compliant with SMPTE 2048-2/274M/292-1/296/428-19/428-9 SD-SDI: Compliant with SMPTE 259M
	HDMI	1 (1 system) type A terminal Contents protection standard: HDCP 2.2
Output	V2420 3G/HD-SDI V2421 12G/6G/3G/HD-SDI	4 (1 pass-thru systems)
	Head phone	1 stereo mini jack, Supported impedance: 32 Ω to 64 Ω
Control	USB	1 USB A receptacle terminal Universal Serial Bus Specification Revision 2.0 compliant LS (Low Speed)/FS (Full Speed)/HS (High Speed) mode compatible Compliant with Enhanced Host Controller Interface Specification for Universal Serial Bus Revision 1.0
	LAN	1 RJ-45 terminal Compliant with IEEE802.3 10BASE-TX/IEEE802.3u 100BASE-TX

Weight and dimensions are approximate. Error and omissions excepted.
 The information in this manual is verified as of May 2019. It is subject to change without notice.

Dimensions

■ Main Unit

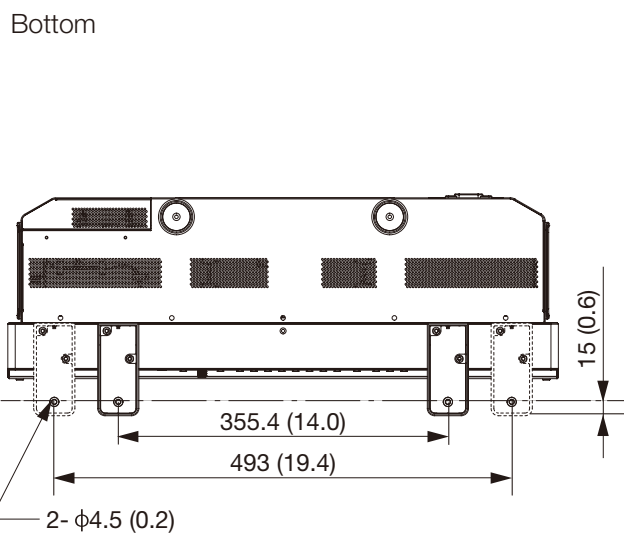
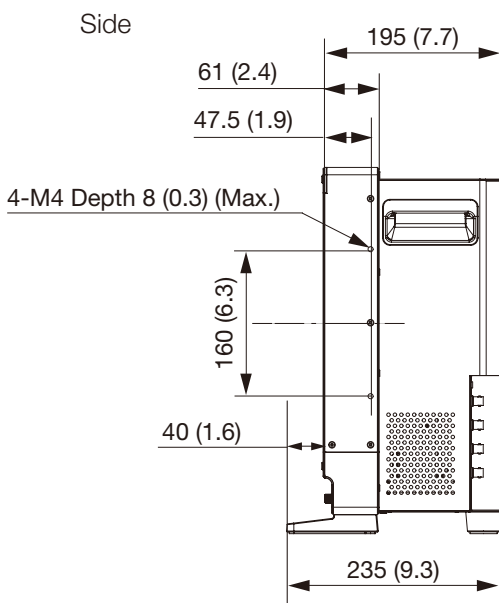
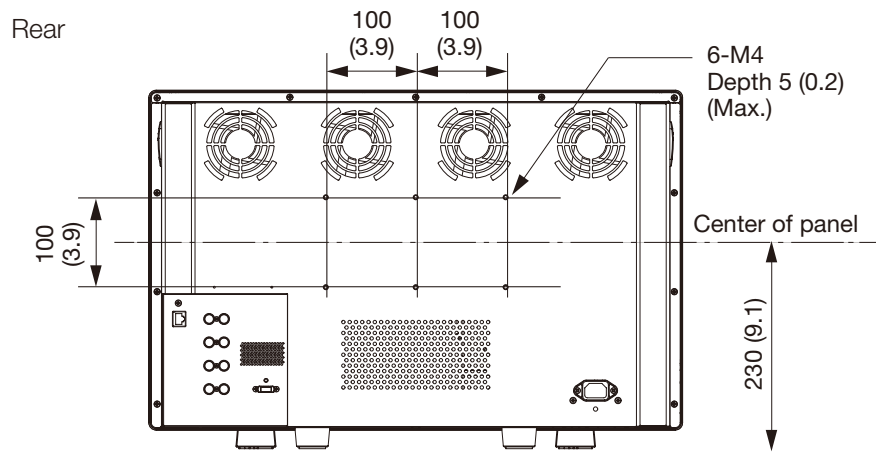
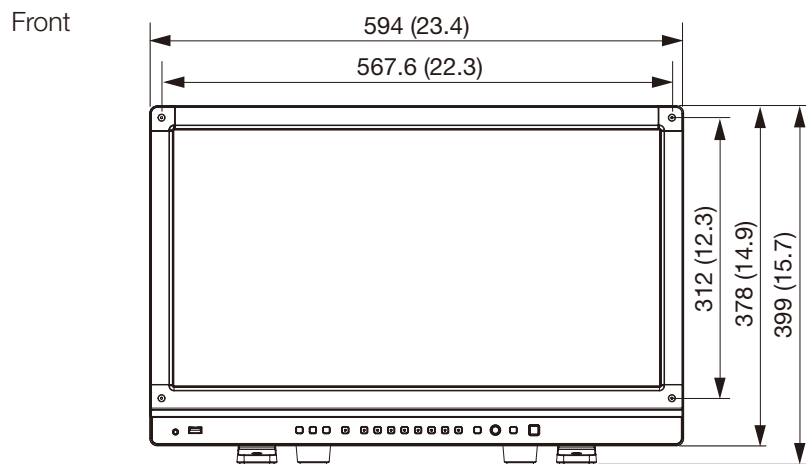

Unit: mm (inch)

Appendix

Supported Signal Format

■ SDI

V2420 : Formats with "*" support audio signals.

V2421 : Formats with "***" do not support audio signals.

Transmission method	Signal format	Color format	Color depth	Standards	
SD-SDI	720x487i 59.94/60.00 Hz**	4:2:2 YCbCr	10-bit	SMPTE-259M	
	720x576i 50.00 Hz**				
HD-SDI	1280x720P 59.94/60.00 Hz*	4:2:2 YCbCr	10-bit	SMPTE 292-1 SMPTE 296	
	1280x720P 50.00 Hz*				
	1280x720P 29.97/30.00 Hz				
	1280x720P 25.00 Hz*				
	1280x720P 23.98/24.00 Hz*				
	1920x1080i 59.94/60.00 Hz*				SMPTE 292-1 SMPTE 274M
	1920x1080i 50.00 Hz*				
	1920x1080P 29.97/30.00 Hz*				
	1920x1080PsF 29.97/30.00 Hz*				
	1920x1080P 25.00 Hz*				
	1920x1080PsF 25.00 Hz*				
	1920x1080P 23.98/24.00 Hz*				
	1920x1080PsF 23.98/24.00 Hz*				
	2048x1080i 59.94/60.00 Hz				
	2048x1080i 50.00 Hz				
	2048x1080P 29.97/30.00 Hz				SMPTE 292-1 SMPTE 428-9 SMPTE 428-19 SMPTE 2048-2
	2048x1080PsF 29.97/30.00 Hz				
	2048x1080P 25.00 Hz				
	2048x1080PsF 25.00 Hz				
	2048x1080P 23.98/24.00 Hz				
2048x1080PsF 23.98/24.00 Hz					

Transmission method	Signal format	Color format	Color depth	Standards
3G-SDI (Level A)	1920x1080i 59.94/60.00 Hz	4:4:4 RGB*	12-bit/10-bit	SMPTE 425-1 SMPTE 274M
		4:4:4 YCbCr*		
		4:2:2 YCbCr	12-bit	
	1920x1080P 50.00 Hz*	4:2:2 YCbCr	10-bit	
	1920x1080i 50.00 Hz	4:4:4 RGB*	12-bit/10-bit	
		4:4:4 YCbCr*		
		4:2:2 YCbCr	12-bit	
	1920x1080P 29.97/30.00 Hz	4:4:4 RGB	12-bit/10-bit	
		4:4:4 YCbCr		
		4:2:2 YCbCr	12-bit	
	1920x1080PsF 29.97/30.00 Hz	4:4:4 RGB*	10-bit	
			12-bit	
		4:4:4 YCbCr*	12-bit	
		4:4:4 YCbCr*	10-bit	
		4:2:2 YCbCr	12-bit	SMPTE 425-1 SMPTE 274M
	1920x1080P 25.00 Hz	4:4:4 RGB	12-bit/10-bit	
		4:4:4 YCbCr		
		4:2:2 YCbCr	12-bit	
	1920x1080PsF 25.00 Hz	4:4:4 RGB*	10-bit	
			12-bit	
		4:4:4 YCbCr*	12-bit	
		4:4:4 YCbCr*	10-bit	
		4:2:2 YCbCr	12-bit	SMPTE 425-1 SMPTE 274M
	1920x1080P 23.98/24.00 Hz	4:4:4 RGB*	12-bit/10-bit	
4:4:4 YCbCr*				
	4:2:2 YCbCr	12-bit		
1920x1080PsF 23.98/24.00 Hz	4:4:4 RGB	10-bit		
		12-bit		
	4:4:4 YCbCr	12-bit		
	4:4:4 YCbCr	10-bit		
	4:2:2 YCbCr	12-bit	SMPTE 425-1 SMPTE 274M	
2048x1080P 59.94/60.00 Hz	4:2:2 YCbCr	10-bit	SMPTE 425-1 SMPTE 428-9 SMPTE 428-19 SMPTE 2048-2	
2048x1080i 59.94/60.00 Hz	4:4:4 RGB	12-bit/10-bit		
	4:4:4 YCbCr			
	4:4:4 X'Y'Z'	12-bit		
	4:2:2 YCbCr			
2048x1080P 50.00 Hz	4:2:2 YCbCr	10-bit	SMPTE 425-1 SMPTE 2048-2	

Transmission method	Signal format	Color format	Color depth	Standards	
3G-SDI (Level A)	2048x1080i 50.00 Hz	4:4:4 RGB	12-bit/10-bit		
		4:4:4 YCbCr			
		4:4:4 X'Y'Z'	12-bit		
		4:2:2 YCbCr			
	2048x1080P 47.95/48.00 Hz	4:2:2 YCbCr	10-bit	SMPTE 425-1 SMPTE 2048-2	
	2048x1080P 29.97/30.00 Hz	4:4:4 RGB	12-bit/10-bit	SMPTE 425-1 SMPTE 428-9	
		4:4:4 X'Y'Z'	12-bit	SMPTE 428-19 SMPTE 2048-2	
		4:4:4 YCbCr	12-bit/10-bit	SMPTE 425-1	
		4:2:2 YCbCr	12-bit	SMPTE 2048-2	
	2048x1080PsF 29.97/30.00 Hz	4:4:4 RGB	12-bit/10-bit	SMPTE 425-1 SMPTE 428-9	
		4:4:4 X'Y'Z'	12-bit	SMPTE 428-19 SMPTE 2048-2	
		4:4:4 YCbCr	12-bit/10-bit	SMPTE 425-1	
		4:2:2 YCbCr	12-bit	SMPTE 2048-2	
	2048x1080P 25.00 Hz	4:4:4 RGB	12-bit/10-bit	SMPTE 425-1 SMPTE 428-9	
		4:4:4 X'Y'Z'	12-bit	SMPTE 428-19 SMPTE 2048-2	
		4:4:4 YCbCr	12-bit/10-bit	SMPTE 425-1	
		4:2:2 YCbCr	12-bit	SMPTE 2048-2	
	2048x1080PsF 25.00 Hz	4:4:4 RGB	12-bit/10-bit	SMPTE 425-1 SMPTE 428-9	
		4:4:4 X'Y'Z'	12-bit	SMPTE 428-19 SMPTE 2048-2	
		4:4:4 YCbCr	12-bit/10-bit	SMPTE 425-1	
4:2:2 YCbCr		12-bit	SMPTE 2048-2		
2048x1080P 23.98/24.00 Hz	4:4:4 RGB	12-bit/10-bit	SMPTE 425-1 SMPTE 428-9		
	4:4:4 X'Y'Z'	12-bit	SMPTE 428-19 SMPTE 2048-2		
	4:4:4 YCbCr	12-bit/10-bit	SMPTE 425-1		
	4:2:2 YCbCr	12-bit	SMPTE 2048-2		
2048x1080PsF 23.98/24.00 Hz	4:4:4 RGB	12-bit/10-bit	SMPTE 425-1 SMPTE 428-9		
	4:4:4 X'Y'Z'	12-bit	SMPTE 428-19 SMPTE 2048-2		
	4:4:4 YCbCr	12-bit/10-bit	SMPTE 425-1		
	4:2:2 YCbCr	12-bit	SMPTE 2048-2		

Transmission method	Signal format	Color format	Color depth	Standards
3G-SDI (Level B)	1920x1080P 59.94/60.00 Hz	4:2:2 YCbCr	10-bit	SMPTE 425-1 SMPTE 372 SMPTE 274M
	1920x1080i 59.94/60.00 Hz	4:4:4 RGB 4:4:4 YCbCr	12-bit/10-bit	
		4:2:2 YCbCr*	12-bit	
	1920x1080P 50.00 Hz	4:2:2 YCbCr	10-bit	
	1920x1080i 50.00 Hz	4:4:4 RGB 4:4:4 YCbCr	12-bit/10-bit	
		4:2:2 YCbCr*	12-bit	
	1920x1080P 29.97/30.00 Hz	4:4:4 RGB 4:4:4 YCbCr	12-bit/10-bit	
		4:2:2 YCbCr	12-bit	
	1920x1080PsF 29.97/30.00 Hz	4:4:4 RGB 4:4:4 YCbCr	12-bit/10-bit	
		4:2:2 YCbCr	12-bit	
	1920x1080P 25.00 Hz	4:4:4 RGB 4:4:4 YCbCr	12-bit/10-bit	
		4:2:2 YCbCr	12-bit	
	1920x1080PsF 25.00 Hz	4:4:4 RGB 4:4:4 YCbCr	12-bit/10-bit	
		4:2:2 YCbCr	12-bit	
	1920x1080P 23.98/24.00 Hz	4:4:4 RGB 4:4:4 YCbCr	12-bit/10-bit	
		4:2:2 YCbCr	12-bit	
	1920x1080PsF 23.98/24.00 Hz	4:4:4 RGB 4:4:4 YCbCr	12-bit/10-bit	
		4:2:2 YCbCr	12-bit	
	2048x1080P 59.94/60.00 Hz	4:2:2 YCbCr	10-bit	SMPTE 425-1 SMPTE 372 SMPTE 428-9 SMPTE 428-19 SMPTE 2048-2
	2048x1080i 59.94/60.00 Hz	4:4:4 RGB 4:4:4 YCbCr	12-bit/10-bit	
4:4:4 X'Y'Z' 4:2:2 YCbCr		12-bit		
2048x1080P 50.00 Hz	4:2:2 YCbCr	10-bit	SMPTE 425-1 SMPTE 372 SMPTE 2048-2	
2048x1080i 50.00 Hz	4:4:4 RGB 4:4:4 YCbCr	12-bit/10-bit		
	4:4:4 X'Y'Z' 4:2:2 YCbCr	12-bit		

Transmission method	Signal format	Color format	Color depth	Standards
3G-SDI (Level B)	2048x1080P 47.95/48.00 Hz	4:2:2 YCbCr	10-bit	SMPTE 425-1 SMPTE 372 SMPTE 2048-2
	2048x1080P 29.97/30.00 Hz	4:4:4 RGB	12-bit/10-bit	SMPTE 425-1 SMPTE 372 SMPTE 428-9 SMPTE 428-19 SMPTE 2048-2
		4:4:4 X'Y'Z'	12-bit	
		4:4:4 YCbCr	12-bit/10-bit	SMPTE 425-1 SMPTE 372 SMPTE 2048-2
		4:2:2 YCbCr	12-bit	
	2048x1080PsF 29.97/30.00 Hz	4:4:4 RGB	12-bit/10-bit	SMPTE 425-1 SMPTE 372 SMPTE 428-9 SMPTE 428-19 SMPTE 2048-2
		4:4:4 X'Y'Z'	12-bit	
		4:4:4 YCbCr	12-bit/10-bit	SMPTE 425-1 SMPTE 372 SMPTE 2048-2
		4:2:2 YCbCr	12-bit	
	2048x1080P 25.00 Hz	4:4:4 RGB	12-bit/10-bit	SMPTE 425-1 SMPTE 372 SMPTE 428-9 SMPTE 428-19 SMPTE 2048-2
		4:4:4 X'Y'Z'	12-bit	
		4:4:4 YCbCr	12-bit/10-bit	SMPTE 425-1 SMPTE 372 SMPTE 2048-2
		4:2:2 YCbCr	12-bit	
	2048x1080PsF 25.00 Hz	4:4:4 RGB	12-bit/10-bit	SMPTE 425-1 SMPTE 372 SMPTE 428-9 SMPTE 428-19 SMPTE 2048-2
		4:4:4 X'Y'Z'	12-bit	
		4:4:4 YCbCr	12-bit/10-bit	SMPTE 425-1 SMPTE 372 SMPTE 2048-2
		4:2:2 YCbCr	12-bit	
	2048x1080P 23.98/24.00 Hz	4:4:4 RGB	12-bit/10-bit	SMPTE 425-1 SMPTE 372 SMPTE 428-9 SMPTE 428-19 SMPTE 2048-2
		4:4:4 X'Y'Z'	12-bit	
		4:4:4 YCbCr	12-bit/10-bit	SMPTE 425-1 SMPTE 372 SMPTE 2048-2
		4:2:2 YCbCr	12-bit	

Transmission method	Signal format	Color format	Color depth	Standards
3G-SDI (Level B)	2048x1080PsF 23.98/24.00 Hz	4:4:4 RGB	12-bit/10-bit	SMPTE 425-1 SMPTE 372 SMPTE 428-9 SMPTE 428-19 SMPTE 2048-2
		4:4:4 X'Y'Z'	12-bit	
		4:4:4 YCbCr	12-bit/10-bit	
		4:2:2 YCbCr	12-bit	
Dual Link 3G-SDI (Level A)	1920x1080P 59.94/60 Hz	4:4:4 RGB	12-bit/10-bit	SMPTE 425-3 SMPTE 274M
		4:4:4 YCbCr		
		4:2:2 YCbCr	12-bit	
	1920x1080P 50 Hz	4:4:4 RGB	12-bit/10-bit	
		4:4:4 YCbCr		
	4:2:2 YCbCr	12-bit		
		2048x1080P 59.94/60 Hz	4:4:4 RGB	12-bit/10-bit
	4:4:4 YCbCr			
	4:4:4 X'Y'Z'		12-bit	
	4:2:2 YCbCr			
	2048x1080P 50 Hz	4:4:4 RGB	12-bit/10-bit	
		4:4:4 YCbCr		
4:4:4 X'Y'Z'		12-bit		
4:2:2 YCbCr				
2048x1080P 47.95/48 Hz	4:4:4 RGB	12-bit/10-bit		
	4:4:4 YCbCr			
	4:4:4 X'Y'Z'	12-bit		
4:2:2 YCbCr				
Dual Link 3G-SDI (Level B)	1920x1080P 59.94/60 Hz	4:4:4 RGB	12-bit/10-bit	SMPTE 425-3 SMPTE 372 SMPTE 274M
		4:4:4 YCbCr		
		4:2:2 YCbCr	12-bit	
	1920x1080P 50 Hz	4:4:4 RGB	12-bit/10-bit	
		4:4:4 YCbCr		
	4:2:2 YCbCr	12-bit		
		2048x1080P 59.94/60 Hz	4:4:4 RGB	12-bit/10-bit
	4:4:4 YCbCr			
	4:4:4 X'Y'Z'		12-bit	
	4:2:2 YCbCr			
	2048x1080P 50 Hz	4:4:4 RGB	12-bit/10-bit	
		4:4:4 YCbCr		
4:4:4 X'Y'Z'		12-bit		
4:2:2 YCbCr				
2048x1080P 47.95/48 Hz	4:4:4 RGB	12-bit/10-bit		
	4:4:4 YCbCr			
	4:4:4 X'Y'Z'	12-bit		
4:2:2 YCbCr				

Transmission method	Signal format	Color format	Color depth	Standards
Dual Link 3G-SDI Square Division (Level B)	3840x2160P 29.97/30 Hz	4:2:2 YCbCr	10-bit	SMPTE 425-3 SMPTE 372 SMPTE 274M
	3840x2160PsF 29.97/30 Hz			
	3840x2160P 25 Hz			
	3840x2160PsF 25 Hz			
	3840x2160P 23.98/24 Hz			
	3840x2160PsF 23.98/24 Hz			
	4096x2160P 29.97/30 Hz			SMPTE 425-3 SMPTE 372 SMPTE 2048-2
	4096x2160PsF 29.97/30 Hz			
	4096x2160P 25 Hz			
	4096x2160PsF 25 Hz			
	4096x2160P 23.98/24 Hz			
	4096x2160PsF 23.98/24 Hz			
Dual Link 3G-SDI 2 Sample Interleave (Level B)	3840x2160P 29.97/30 Hz	4:2:2 YCbCr	10-bit	SMPTE 425-3 SMPTE 372 SMPTE 274M
	3840x2160P 25 Hz			
	3840x2160P 23.98/24 Hz			
	4096x2160P 29.97/30 Hz			SMPTE 425-3 SMPTE 372 SMPTE 2048-2
	4096x2160P 25 Hz			
	4096x2160P 23.98/24 Hz			
Quad Link HD-SDI	3840x2160i 59.94/60.00 Hz*	4:2:2 YCbCr	10-bit	SMPTE 292-1 SMPTE 274M
	3840x2160i 50.00 Hz*			
	3840x2160P 29.97/30.00 Hz*			
	3840x2160PsF 29.97/30.00 Hz*			
	3840x2160P 25.00 Hz*			
	3840x2160PsF 25.00 Hz*			
	3840x2160P 23.98/24.00 Hz*			
	3840x2160PsF 23.98/24.00 Hz*			
	4096x2160i 59.94/60.00 Hz			
	4096x2160i 50.00 Hz			
	4096x2160P 29.97/30.00 Hz			
	4096x2160PsF 29.97/30.00 Hz			
	4096x2160P 25.00 Hz			
	4096x2160PsF 25.00 Hz			
	4096x2160P 23.98/24.00 Hz			
	4096x2160PsF 23.98/24.00 Hz			

Transmission method	Signal format	Color format	Color depth	Standards
Quad Link 3G-SDI (Level A)	3840x2160P 59.94/60.00 Hz	4:2:2 YCbCr*	10-bit	SMPTE 425-1 SMPTE 274M
	3840x2160i 59.94/60.00 Hz	4:4:4 RGB*	12-bit/10-bit	
		4:4:4 YCbCr*		
		4:2:2 YCbCr	12-bit	
	3840x2160P 50.00 Hz	4:2:2 YCbCr*	12-bit	
	3840x2160i 50.00 Hz	4:4:4 RGB*	12-bit/10-bit	
		4:4:4 YCbCr*		
	4:2:2 YCbCr	12-bit		
		3840x2160P 29.97/30.00 Hz	4:4:4 RGB	12-bit/10-bit
	4:4:4 YCbCr			
		4:2:2 YCbCr	12-bit	
	3840x2160PsF 29.97/30.00 Hz	4:4:4 RGB*	10-bit	
			12-bit	
		4:4:4 YCbCr*	12-bit	
		4:4:4 YCbCr*	10-bit	SMPTE 425-1 SMPTE 274M
	4:2:2 YCbCr	12-bit		
	3840x2160P 25.00 Hz	4:4:4 RGB	12-bit/10-bit	
		4:4:4 YCbCr		
	4:2:2 YCbCr	12-bit		
		3840x2160PsF 25.00 Hz	4:4:4 RGB*	10-bit
	12-bit			
	4:4:4 YCbCr*		12-bit	
	4:4:4 YCbCr*		10-bit	SMPTE 425-1 SMPTE 274M
	4:2:2 YCbCr	12-bit		
3840x2160P 23.98/24.00 Hz	4:4:4 RGB*	12-bit/10-bit		
	4:4:4 YCbCr*			
4:2:2 YCbCr	12-bit			
	3840x2160PsF 23.98/24.00 Hz	4:4:4 RGB	10-bit	
12-bit				
4:4:4 YCbCr		12-bit		
4:4:4 YCbCr		10-bit	SMPTE 425-1 SMPTE 274M	
4:2:2 YCbCr	12-bit			
4096x2160P 59.94/60.00 Hz	4:2:2 YCbCr	10-bit	SMPTE 425-1 SMPTE 428-9 SMPTE 428-19 SMPTE 2048-2	
4096x2160i 59.94/60.00 Hz	4:4:4 RGB	12-bit/10-bit		
	4:4:4 YCbCr			
	4:4:4 X'Y'Z'	12-bit		
4:2:2 YCbCr				

Transmission method	Signal format	Color format	Color depth	Standards
Quad Link 3G-SDI (Level A)	4096x2160P 50.00 Hz	4:2:2 YCbCr	10-bit	SMPTE 425-1 SMPTE 2048-2
	4096x2160i 50.00 Hz	4:4:4 RGB 4:4:4 YCbCr	12-bit/10-bit	
		4:4:4 X'Y'Z' 4:2:2 YCbCr	12-bit	
	4096x2160P 47.95/48.00 Hz	4:2:2 YCbCr	10-bit	SMPTE 425-1 SMPTE 2048-2
	4096x2160P 29.97/30.00 Hz	4:4:4 RGB	12-bit/10-bit	SMPTE 425-1 SMPTE 428-9 SMPTE 428-19 SMPTE 2048-2
		4:4:4 X'Y'Z'	12-bit	
		4:4:4 YCbCr	12-bit/10-bit	SMPTE 425-1 SMPTE 2048-2
		4:2:2 YCbCr	12-bit	
	4096x2160PsF 29.97/30.00 Hz	4:4:4 RGB	12-bit/10-bit	SMPTE 425-1 SMPTE 428-9 SMPTE 428-19 SMPTE 2048-2
		4:4:4 X'Y'Z'	12-bit	
		4:4:4 YCbCr	12-bit/10-bit	SMPTE 425-1 SMPTE 2048-2
		4:2:2 YCbCr	12-bit	
	4096x2160P 25.00 Hz	4:4:4 RGB	12-bit/10-bit	SMPTE 425-1 SMPTE 428-9 SMPTE 428-19 SMPTE 2048-2
		4:4:4 X'Y'Z'	12-bit	
		4:4:4 YCbCr	12-bit/10-bit	SMPTE 425-1 SMPTE 2048-2
		4:2:2 YCbCr	12-bit	
	4096x2160PsF 25.00 Hz	4:4:4 RGB	12-bit/10-bit	SMPTE 425-1 SMPTE 428-9 SMPTE 428-19 SMPTE 2048-2
		4:4:4 X'Y'Z'	12-bit	
		4:4:4 YCbCr	12-bit/10-bit	SMPTE 425-1 SMPTE 2048-2
		4:2:2 YCbCr	12-bit	
	4096x2160P 23.98/24.00 Hz	4:4:4 RGB	12-bit/10-bit	SMPTE 425-1 SMPTE 428-9 SMPTE 428-19 SMPTE 2048-2
		4:4:4 X'Y'Z'	12-bit	
		4:4:4 YCbCr	12-bit/10-bit	SMPTE 425-1 SMPTE 2048-2
		4:2:2 YCbCr	12-bit	
4096x2160PsF 23.98/24.00 Hz	4:4:4 RGB	12-bit/10-bit	SMPTE 425-1 SMPTE 428-9 SMPTE 428-19 SMPTE 2048-2	
	4:4:4 X'Y'Z'	12-bit		
	4:4:4 YCbCr	12-bit/10-bit	SMPTE 425-1 SMPTE 2048-2	
	4:2:2 YCbCr	12-bit		

Transmission method	Signal format	Color format	Color depth	Standards	
Quad Link 3G-SDI 2 Sample Interleave (Level A)	3840x2160P 59.94/60 Hz	4:2:2 YCbCr	10-bit	SMPTE 425-5 SMPTE 274M	
	3840x2160P 50 Hz	4:2:2 YCbCr	10-bit		
	3840x2160P 29.97/30 Hz	4:4:4 RGB	12-bit/10-bit		
		4:4:4 YCbCr	12-bit		
	3840x2160P 25 Hz	4:4:4 RGB	12-bit/10-bit		
		4:4:4 YCbCr	12-bit		
	3840x2160P 23.98/24 Hz	4:4:4 RGB	12-bit/10-bit		
		4:4:4 YCbCr	12-bit		
	Quad Link 3G-SDI (Level B)	4096x2160P 59.94/60 Hz	4:2:2 YCbCr	10-bit	SMPTE 425-5 SMPTE 428-9 SMPTE 428-19 SMPTE 2048-2
		4096x2160P 50 Hz	4:2:2 YCbCr	10-bit	
		4096x2160P 47.95/48 Hz	4:2:2 YCbCr	10-bit	
		4096x2160P 29.97/30 Hz	4:4:4 RGB	12-bit/10-bit	
4:4:4 X'Y'Z'			12-bit		
4:4:4 YCbCr			12-bit/10-bit		
4:2:2 YCbCr			12-bit		
4096x2160P 25 Hz		4:4:4 RGB	12-bit/10-bit		
		4:4:4 X'Y'Z'	12-bit		
		4:4:4 YCbCr	12-bit/10-bit		
		4:2:2 YCbCr	12-bit		
4096x2160P 23.98/24 Hz		4:4:4 RGB	12-bit/10-bit		
		4:4:4 X'Y'Z'	12-bit		
		4:4:4 YCbCr	12-bit/10-bit		
		4:2:2 YCbCr	12-bit		
Quad Link 3G-SDI (Level B)		3840x2160P 59.94/60.00 Hz	4:2:2 YCbCr	10-bit	
	3840x2160i 59.94/60.00 Hz	4:4:4 RGB	12-bit/10-bit		
		4:4:4 YCbCr	12-bit		
	3840x2160P 50.00 Hz	4:2:2 YCbCr*	10-bit		

Transmission method	Signal format	Color format	Color depth	Standards
Quad Link 3G-SDI (Level B)	3840x2160i 50.00 Hz	4:4:4 RGB	12-bit/10-bit	SMPTE 425-1 SMPTE 372 SMPTE 274M
		4:4:4 YCbCr		
	3840x2160P 29.97/30.00 Hz	4:2:2 YCbCr*	12-bit	
		4:4:4 RGB	12-bit/10-bit	
	3840x2160P 29.97/30.00 Hz	4:4:4 YCbCr	12-bit	
		4:2:2 YCbCr	12-bit	
	3840x2160PsF 29.97/30.00 Hz	4:4:4 RGB	12-bit/10-bit	
		4:4:4 YCbCr	12-bit	
	3840x2160P 25.00 Hz	4:2:2 YCbCr	12-bit	
		4:4:4 RGB	12-bit/10-bit	
	3840x2160PsF 25.00 Hz	4:4:4 YCbCr	12-bit	
		4:2:2 YCbCr	12-bit	
	3840x2160P 23.98/24.00 Hz	4:4:4 RGB	12-bit/10-bit	
		4:4:4 YCbCr	12-bit	
3840x2160PsF 23.98/24.00 Hz	4:2:2 YCbCr	12-bit		
	4:4:4 RGB	12-bit/10-bit		
4096x2160P 59.94/60.00 Hz	4096x2160P 59.94/60.00 Hz	4:4:4 YCbCr	10-bit	SMPTE 425-1 SMPTE 372 SMPTE 428-9 SMPTE 428-19 SMPTE 2048-2
		4:2:2 YCbCr	12-bit	
	4096x2160i 59.94/60.00 Hz	4:4:4 RGB	12-bit/10-bit	
		4:4:4 YCbCr	12-bit	
	4096x2160P 50.00 Hz	4:4:4 X'Y'Z'	12-bit	
		4:2:2 YCbCr	10-bit	
	4096x2160i 50.00 Hz	4:4:4 RGB	12-bit/10-bit	
		4:4:4 YCbCr	12-bit	
	4096x2160P 47.95/48.00 Hz	4:4:4 X'Y'Z'	12-bit	
		4:2:2 YCbCr	10-bit	
	4096x2160P 47.95/48.00 Hz	4:4:4 RGB	12-bit/10-bit	
		4:4:4 YCbCr	12-bit	
	4096x2160P 47.95/48.00 Hz	4:2:2 YCbCr	10-bit	
		4:4:4 RGB	12-bit/10-bit	
4096x2160P 47.95/48.00 Hz	4:4:4 YCbCr	12-bit		
	4:2:2 YCbCr	10-bit		

Transmission method	Signal format	Color format	Color depth	Standards
Quad Link 3G-SDI (Level B)	4096x2160P 29.97/30.00 Hz	4:4:4 RGB	12-bit/10-bit	SMPTE 425-1 SMPTE 372
		4:4:4 X'Y'Z'	12-bit	SMPTE 428-9 SMPTE 428-19 SMPTE 2048-2
		4:4:4 YCbCr	12-bit/10-bit	SMPTE 425-1 SMPTE 372
		4:2:2 YCbCr	12-bit	SMPTE 2048-2
	4096x2160PsF 29.97/30.00 Hz	4:4:4 RGB	12-bit/10-bit	SMPTE 425-1 SMPTE 372
		4:4:4 X'Y'Z'	12-bit	SMPTE 428-9 SMPTE 428-19 SMPTE 2048-2
		4:4:4 YCbCr	12-bit/10-bit	SMPTE 425-1 SMPTE 372
		4:2:2 YCbCr	12-bit	SMPTE 2048-2
	4096x2160P 25.00 Hz	4:4:4 RGB	12-bit/10-bit	SMPTE 425-1 SMPTE 372
		4:4:4 X'Y'Z'	12-bit	SMPTE 428-9 SMPTE 428-19 SMPTE 2048-2
		4:4:4 YCbCr	12-bit/10-bit	SMPTE 425-1 SMPTE 372
		4:2:2 YCbCr	12-bit	SMPTE 2048-2
	4096x2160PsF 25.00 Hz	4:4:4 RGB	12-bit/10-bit	SMPTE 425-1 SMPTE 372
		4:4:4 X'Y'Z'	12-bit	SMPTE 428-9 SMPTE 428-19 SMPTE 2048-2
		4:4:4 YCbCr	12-bit/10-bit	SMPTE 425-1 SMPTE 372
		4:2:2 YCbCr	12-bit	SMPTE 2048-2
	4096x2160P 23.98/24.00 Hz	4:4:4 RGB	12-bit/10-bit	SMPTE 425-1 SMPTE 372
		4:4:4 X'Y'Z'	12-bit	SMPTE 428-9 SMPTE 428-19 SMPTE 2048-2
		4:4:4 YCbCr	12-bit/10-bit	SMPTE 425-1 SMPTE 372
		4:2:2 YCbCr	12-bit	SMPTE 2048-2
4096x2160PsF 23.98/24.00 Hz	4:4:4 RGB	12-bit/10-bit	SMPTE 425-1 SMPTE 372	
	4:4:4 X'Y'Z'	12-bit	SMPTE 428-9 SMPTE 428-19 SMPTE 2048-2	
	4:4:4 YCbCr	12-bit/10-bit	SMPTE 425-1 SMPTE 372	
	4:2:2 YCbCr	12-bit	SMPTE 2048-2	

Transmission method	Signal format	Color format	Color depth	Standards	
Quad Link 3G-SDI 2 Sample Interleave (Level B)	3840x2160P 59.94/60 Hz	4:2:2 YCbCr	10-bit	SMPTE 425-5 SMPTE 372 SMPTE 274M	
	3840x2160P 50 Hz	4:2:2 YCbCr	10-bit		
	3840x2160P 29.97/30 Hz	4:4:4 RGB	12-bit/10-bit		
		4:4:4 YCbCr	12-bit		
	3840x2160P 25 Hz	4:4:4 RGB	12-bit/10-bit		
		4:4:4 YCbCr	12-bit		
	3840x2160P 23.98/24 Hz	4:4:4 RGB	12-bit/10-bit		
		4:4:4 YCbCr	12-bit		
	4096x2160P 59.94/60 Hz	4:2:2 YCbCr	10-bit	SMPTE 425-5 SMPTE 372 SMPTE 428-9 SMPTE 428-19 SMPTE 2048-2	
		4096x2160P 50 Hz	4:2:2 YCbCr		10-bit
		4096x2160P 47.95/48 Hz	4:2:2 YCbCr		10-bit
		4096x2160P 29.97/30 Hz	4:4:4 RGB		12-bit/10-bit
4:4:4 X'Y'Z'			12-bit		
4:4:4 YCbCr			12-bit/10-bit		
4:2:2 YCbCr			12-bit		
4096x2160P 25 Hz		4:4:4 RGB	12-bit/10-bit		
		4:4:4 X'Y'Z'	12-bit		
		4:4:4 YCbCr	12-bit/10-bit		
		4:2:2 YCbCr	12-bit		
4096x2160P 23.98/24 Hz		4:4:4 RGB	12-bit/10-bit		
		4:4:4 X'Y'Z'	12-bit		
		4:4:4 YCbCr	12-bit/10-bit		
		4:2:2 YCbCr	12-bit		
V2421 6G-SDI		3840x2160P 29.97/30.00 Hz	4:2:2 YCbCr		10-bit
	3840x2160P 25.00Hz				
	3840x2160P 23.98/24.00 Hz				
	4096x2160P 25.00Hz				
	4096x2160P 23.98/24.00 Hz				
V2421 Dual Link 6G-SDI Square Division, 2 Sample Interleave	3840x2160P 59.94/60.00 Hz	4:2:2 YCbCr	10-bit	SMPTE 2081-11	
	3840x2160P 50.00 Hz				

Transmission method	Signal format	Color format	Color depth	Standards
V2421 12G-SDI	3840x2160P 29.97/30.00 Hz	4:4:4 RGB 4:4:4 YCbCr	12-bit/10-bit	SMPTE 2082-10
		4:2:2 YCbCr	12-bit	
	3840x2160P 25.00 Hz	4:4:4 RGB 4:4:4 YCbCr	12-bit/10-bit	
		4:2:2 YCbCr	12-bit	
	3840x2160P 23.98/24.00 Hz	4:4:4 RGB 4:4:4 YCbCr	12-bit/10-bit	
		4:2:2 YCbCr	12-bit	
	4096x2160P 25.00 Hz	4:4:4 RGB 4:4:4 YCbCr	12-bit/10-bit	
		4:4:4 X'Y'Z' 4:2:2 YCbCr	12-bit	
	4096x2160P 23.98/24.00 Hz	4:4:4 RGB 4:4:4 YCbCr	12-bit/10-bit	
		4:4:4 X'Y'Z' 4:2:2 YCbCr	12-bit	
	3840x2160P 59.94/60.00 Hz	4:2:2 YCbCr	10-bit	
	3840x2160P 50.00Hz			
4096x2160P 47.95/48.00 Hz				
4096x2160P 59.94/60.00Hz				
4096x2160P 50.00Hz				

■ RAW

Signal format
3840x2160P 59.94 Hz, 50.00 Hz, 29.97 Hz, 25.00 Hz, 24.00 Hz, 23.98 Hz
4096x2160P 59.94 Hz, 50.00 Hz, 29.97 Hz, 25.00 Hz, 24.00 Hz, 23.98 Hz

■ HDMI

Signal format	Color format/Color depth
640x480P 59.94/60.00 Hz	4:4:4 RGB 8-bit
800x600P 60.00 Hz	
1024x768P 60.00 Hz	
720x480P 59.94/60.00 Hz	4:4:4 RGB 12-bit/10-bit/8-bit 4:4:4 YCbCr 12-bit/10-bit/8-bit 4:2:2 YCbCr 12-bit
720x576P 50.00 Hz	
1280x720P 59.94/60.00 Hz	
1280x720P 50.00 Hz	
1920x1080P 59.94/60.00 Hz	
1920x1080i 59.94/60.00 Hz	
1920x1080P 50.00 Hz	
1920x1080i 50.00 Hz	
1920x1080P 29.97/30.00 Hz	
1920x1080P 25.00 Hz	
1920x1080P 23.98/24.00 Hz	
2048x1080P 59.94/60.00 Hz	
2048x1080P 50.00 Hz	
2048x1080P 29.97/30.00 Hz	
2048x1080P 25.00 Hz	
2048x1080P 23.98/24.00 Hz	
3840x2160P 59.94/60.00 Hz	4:4:4 RGB 8-bit 4:4:4 YCbCr 8-bit 4:2:2 YCbCr 12-bit 4:2:0 YCbCr 12-bit/10-bit/8-bit
3840x2160P 50.00 Hz	
3840x2160P 29.97/30.00 Hz	4:4:4 RGB 12-bit/10-bit/8-bit 4:4:4 YCbCr 12-bit/10-bit/8-bit 4:2:2 YCbCr 12-bit
3840x2160P 25.00 Hz	
3840x2160P 23.98/24.00 Hz	
4096x2160P 59.94/60.00 Hz	4:4:4 RGB 8-bit 4:4:4 YCbCr 8-bit 4:2:2 YCbCr 12-bit 4:2:0 YCbCr 12-bit/10-bit/8-bit
4096x2160P 50.00 Hz	
4096x2160P 29.97/30.00 Hz	4:4:4 RGB 12-bit/10-bit/8-bit 4:4:4 YCbCr 12-bit/10-bit/8-bit 4:2:2 YCbCr 12-bit
4096x2160P 25.00 Hz	
4096x2160P 23.98/24.00 Hz	

Image/Frame Display

■ SDI

Signal system			Display Method	
720x487	59.94/60.00	i	59.94/60.00	P
720x576	50.00	i	50.00	P
1280x720	23.98/24.00	P	47.96/48.00	P*
	25.00	P	50.00	P*
	29.97/30.00	P	59.94/60.00	P*
	50.00	P	50.00	P
	59.94/60.00	P	59.94/60.00	P
1920x1080	50.00	i	50.00	P
	59.94/60.00	i	59.94/60.00	P
	23.98/24.00	PsF	47.96/48.00	P*
	25.00	PsF	50.00	P*
	29.97/30.00	PsF	59.94/60.00	P*
	23.98/24.00	P	47.96/48.00	P*
	25.00	P	50.00	P*
	29.97/30.00	P	59.94/60.00	P*
	50.00	P	50.00	P
59.94/60.00	P	59.94/60.00	P	
2048x1080	50.00	i	50.00	P
	59.94/60.00	i	59.94/60.00	P
	23.98/24.00	PsF	47.96/48.00	P*
	25.00	PsF	50.00	P*
	29.97/30.00	PsF	59.94/60.00	P*
	23.98/24.00	P	47.96/48.00	P*
	25.00	P	50.00	P*
	29.97/30.00	P	59.94/60.00	P*
	47.95/48.00	P	47.95/48.00	P
	50.00	P	50.00	P
	59.94/60.00	P	59.94/60.00	P
3840x2160	50.00	i	50.00	P
	59.94/60.00	i	59.94/60.00	P
	23.98/24.00	PsF	47.96/48.00	P*
	25.00	PsF	50.00	P*
	29.97/30.00	PsF	59.94/60.00	P*
	23.98/24.00	P	47.96/48.00	P*
	25.00	P	50.00	P*
	29.97/30.00	P	59.94/60.00	P*
	50.00	P	50.00	P
59.94/60.00	P	59.94/60.00	P	

Signal system			Display Method	
4096x2160	50.00	i	50.00	P
	59.94/60.00	i	59.94/60.00	P
	23.98/24.00	PsF	47.96/48.00	P*
	25.00	PsF	50.00	P*
	29.97/30.00	PsF	59.94/60.00	P*
	23.98/24.00	P	47.96/48.00	P*
	25.00	P	50.00	P*
	29.97/30.00	P	59.94/60.00	P*
	47.95/48.00	P	47.95/48.00	P
	50.00	P	50.00	P
	59.94/60.00	P	59.94/60.00	P

* : Displaying same frame

■ HDMI

Signal system			Display Method	
640x480	59.94/60.00	P	59.94/60.00	P
800x600	60.00	P	60.00	P
720x480P	59.94/60.00	P	59.94/60.00	P
720x576	50.00	P	50.00	P
1024x768	60.00	P	60.00	P
1280x720	59.94/60.00	P	59.94/60.00	P
1280x720	50.00	P	50.00	P
1920x1080	59.94/60.00	P	59.94/60.00	P
1920x1080	59.94/60.00	i	59.94/60.00	P
1920x1080	50.00	P	50.00	P
1920x1080	50.00	i	50.00	P
1920x1080	59.94/60.00	i	59.94/60.00	P
1920x1080	29.97/30.00	P	59.94/60.00	P*
1920x1080	25.00	P	50.00	P*
1920x1080	23.98/24.00	P	47.96/48.00	P*
2048x1080	59.94/60.00	P	59.94/60.00	P
2048x1080	50.00	P	50.00	P
2048x1080	29.97/30.00	P	59.94/60.00	P*
2048x1080	25.00	P	50.00	P*
2048x1080	23.98/24.00	P	47.96/48.00	P*
3840x2160	59.94/60.00	P	59.94/60.00	P
3840x2160	50.00	P	50.00	P
3840x2160	29.97/30.00	P	59.94/60.00	P*
3840x2160	25.00	P	50.00	P*
3840x2160	23.98/24.00	P	47.96/48.00	P*
4096x2160	59.94/60.00	P	59.94/60.00	P
4096x2160	50.00	P	50.00	P
4096x2160	29.97/30.00	P	59.94/60.00	P*
4096x2160	25.00	P	50.00	P*
4096x2160	23.98/24.00	P	47.96/48.00	P*

* : Displaying same frame







Error Messages



Message		Description and Action
Calibration	Failed to initialize the external sensor.	See CA-310 and CA-210 instruction manual.
	Calibration error.	<ul style="list-style-type: none"> • Check the installation and connection of the external sensor and retry (📖27). • Perform matrix calibration of CA-310 and CA-210 (📖27).
	Calibration is completed. (Brightness setting is lower than target brightness.)	Set the "Luminance" in calibration again (📖59).
	Failed to detect the external sensor. Please check the connection with the sensor.	Correctly connect the external sensor to the USB port of this main unit.
Network	Communication error.	IP address may be in conflict or there may be a network communication error. Check the network environment.
	Invalid IP Address.	Enter the correct IP address.
	Invalid Subnet Mask.	Enter the correct subnet mask.
	Display is not connected.	Check that the Canon display to which you wish to export this video display's settings and this video display are correctly connected with a LAN cable.
Various settings, CDL export	The USB memory is full.	Use another USB memory or delete the content of the memory.
	Failed to write file.	The USB memory may be defective or protected. Check the USB memory.
LUT, Various settings, CDL import	(LUT Import) "LUT Type" is different. (CDL Import) "File Type" is different.	Select the correct file format.
	Failed to read file.	The USB memory may be defective or protected. Check the USB memory.
	Failed to import.	There is an error in the file to be imported. Check the file.
	No import file.	Check and ensure that the file has been saved to the USB memory or imported to "User 1-3".

Message		Description and Action
Screen Capture	Failed to capture.	The USB memory may be defective or protected. Check the USB memory.
	Invalid Signal.	A screen displaying no video is being captured for example there is no signal or an unsupported signal is being input. Check the signal, input it again, and capture it.
	Copy protected signal.	The signal you tried to capture may be protected by HDCP 2.2 which is a copy prevention standard for HDMI. In this case, the signal cannot be captured. Check the HDMI signal.
	Failed to playback file.	The USB memory or the file may be defective or protected. Check the USB memory or the file.
	No capture file.	Check and ensure that the file has been saved to the USB memory.
Hardware error	Backlight error.	Disconnect the power cord, reconnect it, and then turn on the power. If the message persists, contact Canon Customer Center.
	Fan error.	
	Panel error.	
	I/F error.	
	System error.	
	Invalid operation due to high temperature.	The temperature inside the main unit is high. Turn off the power and wait until the fan stops.
Input signal	No Signal	Displayed when there is no video signal input.
	Unsupported	Unsupported video signal is input. Check the supported signal format (112).
Operation	Invalid operation.	Operation is disabled. Check the setting items.
	"Protect Settings" is on.	To use the OSD menu, move the selection frame to "Protect" and press the jog dial for approximately 3 seconds.
	"CDL/User LUT Bypass" is on.	When "CDL/User LUT Bypass" is turned "On", you cannot adjust "Power", "Saturation", "Offset", or "Slope".
	Invalid Password.	Enter the correct password.
USB memory	USB memory is not connected.	Correctly connect the USB memory to the USB port of this main unit.
	Unsupported USB memory.	Check the USB memory format and make sure it is not protected.
Wi-Fi adapter	Wi-Fi Adaptor is not connected.	Correctly connect the Wi-Fi adapter to the USB terminal of the video display.
	Failed to connect Wi-Fi Access Point.	The password may be wrong, or there may be a network communication error. Check the network environment.

Message		Description and Action
Firmware Update	No update file.	Firmware update files are not saved on USB memory or other media.
	Failed to read update file.	There is an error in the file. Check the file.
	The firmware/license has been already updated.	This is the file that is updated on the video display.

Troubleshooting

Symptom	Cause and Action	
Power does not turn on. (Power indicator does not turn on.)	<ul style="list-style-type: none"> • Press the  button. 	12
	<ul style="list-style-type: none"> • Check that the AC power cord is connected correctly. 	21
	<ul style="list-style-type: none"> • Brightness of the power indicator may be turned off. Turn it on and check once more. 	103
The screen is dark.	When the power indicator does not turn on: <ul style="list-style-type: none"> • Press the  button. • Check that the AC power cord is connected correctly. 	12 21
	When the power indicator is lit orange: <ul style="list-style-type: none"> • Press the  button. 	12
	When the power indicator is flashing orange: <ul style="list-style-type: none"> • Flashing once every 3 seconds : Contact Canon Customer Center. • Flashing twice every 3 seconds : <ul style="list-style-type: none"> - Turn on the power with the  button. - The temperature of the display rises (or falls) depend on operation environment. Check the environmental conditions ( 109) and do not use in direct sunlight. - If the power still does not turn on, contact Canon Customer Cente. 	12 109
The image does not display.	<ul style="list-style-type: none"> • Set each item in "Channel Settings" according to input signa. 	64
The 3G-SDI RAW signal image does not display.	<ul style="list-style-type: none"> • At times the 3G-SDI RAW signal image may not display, depending on the type of the Cinema EOS camera. Refer to the Canon website for a list of supported products. 	—
There is a blank area when set to Quad Input/Dual Input.	<ul style="list-style-type: none"> • There may be no input signal. Look at the display area icon in the interface area and check that the input area and signal cables are properly connected. • V2420 Signals with different resolution or frequency may be input from each terminal. Check the signal. • V2421 Some combinations are not supported. Check the signal. 	19 65, 108
The image appears to be delayed.	When "Reduce Backlight Flash" is set to "On", the displayed image may be delayed depending on the scene. In such case, change the setting to "Off".	104
Video paused temporarily	The screen may pause when running "Capture" via a web browser. When "Capture" is complete, or turning "Web" → "Control" to "Off" will return to normal scree.	38
Screen is too bright/dark.	<ul style="list-style-type: none"> • Adjust the "Contrast" on the OSD menu. • There is a limit on the service life of LCD backlight. If the screen becomes dark or starts flickering, contact Canon Customer Cente. 	49
Burn-in image appears.	<ul style="list-style-type: none"> • This is a characteristic of the LCD panel and you should avoid displaying stationary image for a long time. 	—

Symptom	Cause and Action	
There is an unlit or red, blue, green, or white dot on screen.	<ul style="list-style-type: none"> LCD display is made of very high precision technology. It has effective pixels of 99.99% or more, but there may be black dots or red, blue, or green dots that may be always on. This is not a failure. 	—
There is an interference pattern or trace that remains when the LCD panel is pressed.	<ul style="list-style-type: none"> The symptom may be resolved by displaying a white or black image on the entire screen. 	—
OSD menu cannot be used.	<ul style="list-style-type: none"> Check that "Protect Settings" is not set. 	102
The F button on the main unit is flashing.	<ul style="list-style-type: none"> When "Peak Luminance Control" is set to "On", the F button assigned with this function flashes when display luminance is restricted. When "Peak Luminance Control" is assigned to two or more F buttons, one of the buttons flashes. 	57
"Aspect Marker", " Safety Zone Marker " or "Area Marker" does not appear.	<ul style="list-style-type: none"> A channel with no signal, unsupported signal, or with "Input Configuration" not set may be selected. Check the signal. 	108
The fan starts to rotate even when "Fan" under "Camera Link" is set to "On" or "Fan Stop" is set to "On".	<ul style="list-style-type: none"> The fan operates to lower the temperature inside the main unit. The fan stops operating when the temperature inside has lowered. When "Fan" under "Camera Link" is set to "On", the down time may not match the camera. 	92 103
The fan does not stop even when "Fan" under "Camera Link" is set to "On" or "Fan Stop" is set to "On".	<ul style="list-style-type: none"> The fan does not stop if the temperature inside the main unit is high. Configure settings after the internal temperature has lowered. The fan may not stop in some conditions, for example when used at a high temperature. Use the video display at the operating temperature ( 109) or lower. 	92 103
Loud fan noise	<ul style="list-style-type: none"> The fan operates at a faster speed than usual to lower the internal temperature if "Fan Control" is set to "On" and when the temperature inside the main unit has increased. The fan operates at normal speed when "Fan Control" is set to "Off". When high-luminance content is displayed continuously, the temperature inside the main unit rises even if the operating temperature is within the recommended range, and the fan operates at a faster speed than usual to lower the internal temperature. It is recommended to lower the brightness of the video display. 	103
You forgot the password for "Protect Settings".	<ul style="list-style-type: none"> Press the jog dial and the  button while the video display is in standby. The configuration will be reset to the state where no password is set. 	12
The video display does not start up in the condition that the power was turned off last time.	<ul style="list-style-type: none"> Check the "Power on Setting" on the OSD menu. Set "Last memory" to start up the video display in the condition that the power is turned off last time. 	105
The image quality for the User mode in "Picture Mode" differs from the image quality of presets.	<ul style="list-style-type: none"> Select the preset mode by "Copy Picture Mode" and copy the settings. 	60
Image quality on the left and right screens is different.	<ul style="list-style-type: none"> Check the "Channel Settings" → "Picture Mode" settings. 	26 67
Image quality is automatically changed.		
The same image is displayed in two screens.	<ul style="list-style-type: none"> Check the "Channel Settings" → "Single Input Dual View" settings. 	68

Software Used in This Product

Software installed with this product includes software modules from Canon or third parties.

Software Developed by Canon and Free Software

Software developed or created by Canon and accompanying document is protected by copyright law, terms of an international convention and any other governing laws.

This product uses software modules under copyright by third parties and distributed as free software. Some of these software modules are subject to the GNU General Public License v2 (GPL), GNU Lesser General Public License v2.1 (LGPL) or any other license.

Free software modules installed with this product

- linux kernel
- SquashFS
- avahi-autoipd
- Newlib(libc)
- openssl
- dhcpcd
- busybox
- FUSE
- libxml
- Newlib(libm)
- libnl
- hostapd
- glibc
- libfuse
- zlib
- wireless_tools
- RealTek_WiFi_linux driver
- JFFS2
- libupnp
- libpng
- wpa_supplicant

Acquiring Source Code for Free Software

Some free software requires the acquirement of the source code of modules in order to distribute the executable form of those software modules. For information on how to acquire the source code for free software such as these and confirming terms of the GPL, LGPL and other license agreements, please check with the distributor from whom the product was purchased.

License Agreement for this Product

Obligation to Present License Agreement

The copyright holders of software modules installed with this product require its license agreement to be displayed. This license agreement is as follows:

■libupnp License

Copyright (c) 2000-2003 Intel Corporation All rights reserved.

Redistribution and use in source and binary forms, with or without modification, are permitted provided that the following conditions are met:

- * Redistributions of source code must retain the above copyright notice, this list of conditions and the following disclaimer.
- * Redistributions in binary form must reproduce the above copyright notice, this list of conditions and the following disclaimer in the documentation and/or other materials provided with the distribution.
- * Neither name of Intel Corporation nor the names of its contributors may be used to endorse or promote products derived from this software without specific prior written permission.

THIS SOFTWARE IS PROVIDED BY THE COPYRIGHT HOLDERS AND CONTRIBUTORS "AS IS" AND ANY EXPRESS OR IMPLIED WARRANTIES, INCLUDING, BUT NOT LIMITED TO, THE IMPLIED WARRANTIES OF MERCHANTABILITY AND FITNESS FOR A PARTICULAR PURPOSE ARE DISCLAIMED. IN NO EVENT SHALL INTEL OR CONTRIBUTORS BE LIABLE FOR ANY DIRECT, INDIRECT, INCIDENTAL, SPECIAL, EXEMPLARY, OR CONSEQUENTIAL DAMAGES (INCLUDING, BUT NOT LIMITED TO, PROCUREMENT OF SUBSTITUTE GOODS OR SERVICES; LOSS OF USE, DATA, OR PROFITS; OR BUSINESS INTERRUPTION) HOWEVER CAUSED AND ON ANY THEORY OF LIABILITY, WHETHER IN CONTRACT, STRICT LIABILITY, OR TORT (INCLUDING NEGLIGENCE OR OTHERWISE) ARISING IN ANY WAY OUT OF THE USE OF THIS SOFTWARE, EVEN IF ADVISED OF THE POSSIBILITY OF SUCH DAMAGE.

■libxml License

Copyright (C) 1998-2003 Daniel Veillard. All Rights Reserved.

Permission is hereby granted, free of charge, to any person obtaining a copy of this software and associated documentation files (the "Software"), to deal in the Software without restriction, including without limitation the rights to use, copy, modify, merge, publish, distribute, sublicense, and/or sell copies of the Software, and to permit persons to whom the Software is furnished to do so, subject to the following conditions:

The above copyright notice and this permission notice shall be included in all copies or substantial portions of the Software.

THE SOFTWARE IS PROVIDED "AS IS", WITHOUT WARRANTY OF ANY KIND, EXPRESS OR IMPLIED, INCLUDING BUT NOT LIMITED TO THE WARRANTIES OF MERCHANTABILITY, FITNESS FOR A PARTICULAR PURPOSE AND NONINFRINGEMENT. IN NO EVENT SHALL THE DANIEL VEILLARD BE LIABLE FOR ANY CLAIM, DAMAGES OR OTHER LIABILITY, WHETHER IN AN ACTION OF CONTRACT, TORT OR OTHERWISE, ARISING FROM, OUT OF OR IN CONNECTION WITH THE SOFTWARE OR THE USE OR OTHER DEALINGS IN THE SOFTWARE.

Except as contained in this notice, the name of Daniel Veillard shall not be used in advertising or otherwise to promote the sale, use or other dealings in this Software without prior written authorization from him.

■Newlib(libc) License

Copyright (c) 1990 The Regents of the University of California. All rights reserved.

Redistribution and use in source and binary forms are permitted provided that the above copyright notice and this paragraph are duplicated in all such forms and that any documentation, and other materials related to such distribution and use acknowledge that the software was developed by the University of California, Berkeley. The name of the University may not be used to endorse or promote products derived from this software without specific prior written permission.

THIS SOFTWARE IS PROVIDED "AS IS" AND WITHOUT ANY EXPRESS OR IMPLIED WARRANTIES, INCLUDING, WITHOUT LIMITATION, THE IMPLIED WARRANTIES OF MERCHANTABILITY AND FITNESS FOR A PARTICULAR PURPOSE.

Copyright (c) 1991, 2000 The Regents of the University of California. All rights reserved.

Redistribution and use in source and binary forms, with or without modification, are permitted provided that the following conditions are met:

1. Redistributions of source code must retain the above copyright notice, this list of conditions and the following disclaimer.
2. Redistributions in binary form must reproduce the above copyright notice, this list of conditions and the following disclaimer in the documentation and/or other materials provided with the distribution.
3. All advertising materials mentioning features or use of this software must display the following acknowledgement:
This product includes software developed by the University of California, Berkeley and its contributors.
4. Neither the name of the University nor the names of its contributors may be used to endorse or promote products derived from this software without specific prior written permission.

THIS SOFTWARE IS PROVIDED BY THE REGENTS AND CONTRIBUTORS "AS IS" AND ANY EXPRESS OR IMPLIED WARRANTIES, INCLUDING, BUT NOT LIMITED TO, THE IMPLIED WARRANTIES OF MERCHANTABILITY AND FITNESS FOR A PARTICULAR PURPOSE ARE DISCLAIMED. IN NO EVENT SHALL THE REGENTS OR CONTRIBUTORS BE LIABLE FOR ANY DIRECT, INDIRECT, INCIDENTAL, SPECIAL, EXEMPLARY, OR CONSEQUENTIAL DAMAGES (INCLUDING, BUT NOT LIMITED TO, PROCUREMENT OF SUBSTITUTE GOODS OR SERVICES; LOSS OF USE, DATA, OR PROFITS; OR BUSINESS INTERRUPTION) HOWEVER CAUSED AND ON ANY THEORY OF LIABILITY, WHETHER IN CONTRACT, STRICT LIABILITY, OR TORT (INCLUDING NEGLIGENCE OR OTHERWISE) ARISING IN ANY WAY OUT OF THE USE OF THIS SOFTWARE, EVEN IF ADVISED OF THE POSSIBILITY OF SUCH DAMAGE.

■Newlib(libm) License

Copyright (C) 1993 by Sun Microsystems, Inc. All rights reserved.

Developed at SunPro, a Sun Microsystems, Inc. business.

Permission to use, copy, modify, and distribute this software is freely granted, provided that this notice is preserved.

■openssl

Copyright (C) 1998-2017 The OpenSSL Project. All rights reserved.

Redistribution and use in source and binary forms, with or without modification, are permitted provided that the following conditions are met:

1. Redistributions of source code must retain the above copyright notice, this list of conditions and the following disclaimer.
2. Redistributions in binary form must reproduce the above copyright notice, this list of conditions and the following disclaimer in the documentation and/or other materials provided with the distribution.
3. All advertising materials mentioning features or use of this software must display the following acknowledgment:
"This product includes software developed by the OpenSSL Project for use in the OpenSSL Toolkit. (<http://www.openssl.org/>)"
4. The names "OpenSSL Toolkit" and "OpenSSL Project" must not be used to endorse or promote products derived from this software without prior written permission. For written permission, please contact openssl-core@openssl.org.
5. Products derived from this software may not be called "OpenSSL" nor may "OpenSSL" appear in their names without prior written permission of the OpenSSL Project.
6. Redistributions of any form whatsoever must retain the following acknowledgment:
"This product includes software developed by the OpenSSL Project for use in the OpenSSL Toolkit (<http://www.openssl.org/>)"

THIS SOFTWARE IS PROVIDED BY THE OpenSSL PROJECT "AS IS" AND ANY EXPRESSED OR IMPLIED WARRANTIES, INCLUDING, BUT NOT LIMITED TO, THE IMPLIED WARRANTIES OF MERCHANTABILITY AND FITNESS FOR A PARTICULAR PURPOSE ARE DISCLAIMED. IN NO EVENT SHALL THE OpenSSL PROJECT OR ITS CONTRIBUTORS BE LIABLE FOR ANY DIRECT, INDIRECT, INCIDENTAL, SPECIAL, EXEMPLARY, OR CONSEQUENTIAL DAMAGES (INCLUDING, BUT NOT LIMITED TO, PROCUREMENT OF SUBSTITUTE GOODS OR SERVICES; LOSS OF USE, DATA, OR PROFITS; OR BUSINESS INTERRUPTION) HOWEVER CAUSED AND ON ANY THEORY OF LIABILITY, WHETHER IN CONTRACT, STRICT LIABILITY, OR TORT (INCLUDING NEGLIGENCE OR OTHERWISE) ARISING IN ANY WAY OUT OF THE USE OF THIS SOFTWARE, EVEN IF ADVISED OF THE POSSIBILITY OF SUCH DAMAGE.

Copyright (C) 1995-1998 Eric Young (eay@cryptsoft.com)
All rights reserved.

This package is an SSL implementation written by Eric Young (eay@cryptsoft.com).
The implementation was written so as to conform with Netscapes SSL.

This library is free for commercial and non-commercial use as long as the following conditions are adhered to. The following conditions apply to all code found in this distribution, be it the RC4, RSA, lhash, DES, etc., code; not just the SSL code. The SSL documentation included with this distribution is covered by the same copyright terms except that the holder is Tim Hudson (tjh@cryptsoft.com).

Copyright remains Eric Young's, and as such any Copyright notices in the code are not to be removed. If this package is used in a product, Eric Young should be given attribution as the author of the parts of the library used. This can be in the form of a textual message at program startup or in documentation (online or textual) provided with the package.

Redistribution and use in source and binary forms, with or without modification, are permitted provided that the following conditions are met:

1. Redistributions of source code must retain the copyright notice, this list of conditions and the following disclaimer.
2. Redistributions in binary form must reproduce the above copyright notice, this list of conditions and the following disclaimer in the documentation and/or other materials provided with the distribution.
3. All advertising materials mentioning features or use of this software must display the following acknowledgement:
"This product includes cryptographic software written by Eric Young (eay@cryptsoft.com)"
The word 'cryptographic' can be left out if the routines from the library being used are not cryptographic related :-).
4. If you include any Windows specific code (or a derivative thereof) from the apps directory (application code) you must include an acknowledgement:
"This product includes software written by Tim Hudson (tjh@cryptsoft.com)"

THIS SOFTWARE IS PROVIDED BY ERIC YOUNG "AS IS" AND ANY EXPRESS OR IMPLIED WARRANTIES, INCLUDING, BUT NOT LIMITED TO, THE IMPLIED WARRANTIES OF MERCHANTABILITY AND FITNESS FOR A PARTICULAR PURPOSE ARE DISCLAIMED. IN NO EVENT SHALL THE AUTHOR OR CONTRIBUTORS BE LIABLE FOR ANY DIRECT, INDIRECT, INCIDENTAL, SPECIAL, EXEMPLARY, OR CONSEQUENTIAL DAMAGES (INCLUDING, BUT NOT LIMITED TO, PROCUREMENT OF SUBSTITUTE GOODS OR SERVICES; LOSS OF USE, DATA, OR PROFITS; OR BUSINESS INTERRUPTION) HOWEVER CAUSED AND ON ANY THEORY OF LIABILITY, WHETHER IN CONTRACT, STRICT LIABILITY, OR TORT (INCLUDING NEGLIGENCE OR OTHERWISE) ARISING IN ANY WAY OUT OF THE USE OF THIS SOFTWARE, EVEN IF ADVISED OF THE POSSIBILITY OF SUCH DAMAGE.

The licence and distribution terms for any publically available version or derivative of this code cannot be changed. i.e. this code cannot simply be copied and put under another distribution licence [including the GNU Public Licence.]

■wpa_supplicant, hostapd

Copyright (C) 2002-2016, Jouni Malinen <j@w1.fi> and contributors
All Rights Reserved.

This software may be distributed, used, and modified under the terms of BSD license:

Redistribution and use in source and binary forms, with or without modification, are permitted provided that the following conditions are met:

1. Redistributions of source code must retain the above copyright notice, this list of conditions and the following disclaimer.
2. Redistributions in binary form must reproduce the above copyright notice, this list of conditions and the following disclaimer in the documentation and/or other materials provided with the distribution.
3. Neither the name(s) of the above-listed copyright holder(s) nor the names of its contributors may be used to endorse or promote products derived from this software without specific prior written permission.

THIS SOFTWARE IS PROVIDED BY THE COPYRIGHT HOLDERS AND CONTRIBUTORS "AS IS" AND ANY EXPRESS OR IMPLIED WARRANTIES, INCLUDING, BUT NOT LIMITED TO, THE IMPLIED WARRANTIES OF MERCHANTABILITY AND FITNESS FOR A PARTICULAR PURPOSE ARE DISCLAIMED. IN NO EVENT SHALL THE COPYRIGHT OWNER OR CONTRIBUTORS BE LIABLE FOR ANY DIRECT, INDIRECT, INCIDENTAL, SPECIAL, EXEMPLARY, OR CONSEQUENTIAL DAMAGES (INCLUDING, BUT NOT LIMITED TO, PROCUREMENT OF SUBSTITUTE GOODS OR SERVICES; LOSS OF USE, DATA, OR PROFITS; OR BUSINESS INTERRUPTION) HOWEVER CAUSED AND ON ANY THEORY OF LIABILITY, WHETHER IN CONTRACT, STRICT LIABILITY, OR TORT (INCLUDING NEGLIGENCE OR OTHERWISE) ARISING IN ANY WAY OUT OF THE USE OF THIS SOFTWARE, EVEN IF ADVISED OF THE POSSIBILITY OF SUCH DAMAGE.

Copyright (c) 2004-2014 by Internet Systems Consortium, Inc. ("ISC")
Copyright (c) 1995-2003 by Internet Software Consortium

Permission to use, copy, modify, and distribute this software for any purpose with or without fee is hereby granted, provided that the above copyright notice and this permission notice appear in all copies.

THE SOFTWARE IS PROVIDED "AS IS" AND ISC DISCLAIMS ALL WARRANTIES WITH REGARD TO THIS SOFTWARE INCLUDING ALL IMPLIED WARRANTIES OF MERCHANTABILITY AND FITNESS. IN NO EVENT SHALL ISC BE LIABLE FOR ANY SPECIAL, DIRECT, INDIRECT, OR CONSEQUENTIAL DAMAGES OR ANY DAMAGES WHATSOEVER RESULTING FROM LOSS OF USE, DATA OR PROFITS, WHETHER IN AN ACTION OF CONTRACT, NEGLIGENCE OR OTHER TORTIOUS ACTION, ARISING OUT OF OR IN CONNECTION WITH THE USE OR PERFORMANCE OF THIS SOFTWARE.

Internet Systems Consortium, Inc.
950 Charter Street
Redwood City, CA 94063
<info@isc.org>
<https://www.isc.org/>

Index

Number	
2 Sample Interleave	65
3G-SDI RAW	64
200% (Screen Scaling)	71
2020 Constant Luminance	58
2020 Gamut Mapping	58
2020 Outside of Gamut View	96
A	
ACESproxy	49
Adjustment	49
Adobe RGB	49
Anamorphic	71, 92
Anchor Adjustment	25, 60
Area Marker	79
Area Marker (Camera Link)	92
Aspect Marker	76
Audio Input	66
Audio Level Meter	82
Audio Settings	75
Automatic Adjustment (ARRI)	91
Automatic Adjustment (CINEMA EOS)	90
Automatic Adjustment (VARICAM)	91
B	
Background Color	74
Backlight Control (Adjustment)	49
Backlight Control (Compatible Settings)	104
Banner	102
Bias R/G/B	50
Bicubic	72
Black (Test Pattern)	88
Blue Off	96
Blue Only	96
Brightness	49
Button Name Lighting Time	103
C	
Calibration	27, 59
Camera Information	92
Camera Link	90
Canon Log, CanonLog 2, Canon Log 3	51
CDL Export/CDL Import	31
CDL/User LUT	56
CDL/User LUT Bypass	56
Center Marker	80
Channel Name	67
Channel Settings	64
Chroma	49
CINEMA EOS SYSTEM (Picture Mode)	49
Cinema Gamut to 709	50
Cinema Gamut to 2020	50
Cinema Gamut to DCI	50
Color Bars (Test Pattern)	88
Color Gamut	50
Color Range	55, 104
Color Temperature	50
Compare View	97
Compatible Settings	104
Contrast	49
Copy Picture Mode	60
Custom (xy) (Color Temperature)	50
D	
Date/Time	31, 101
DCI-P3	49
DCI-P3+ to 709	50
DCI-P3+ to DCI	50
Detail Settings	
Adjustment	57
CDL/User LUT	56
Display Button LED	103
Display Channel	101
Display Function/Display Function (CDL)	101
Display Name	32, 102
Display Setting Link	100
Display Settings	71
Dual Input	64
Dual Link 3G-SDI	65
E	
EBU	49
Export/Import	30, 104
F	
False Color	94
Fan (Camera Link)	92
Fan Settings	103
Film Cadence	74
Firmware/License Update	104
Firmware/License Ver.	108
Format	66

Frame Hold	74
Frame Luminance Monitor	86
Function Button Guide.....	102
Function/Channel Button	101
Function Settings.....	81

G

Gain R/G/B.....	50
Gamma/EOTF	51
Gamma LUT.....	51
Gamut LUT.....	50
Gray (Test Pattern).....	88
Green Off.....	96
Grid Marker	80

H

HDMI.....	13, 20, 104
HDMI Link	59
HDR Range	53
HDR/SDR View	58
Hide OSD	101
Histogram.....	84
Hybrid Log-Gamma.....	51
Hybrid Log-Gamma System	58

I

Image Division	65
Image Priority	74
Input Configuration	64
Input Transform	54
Internal Sync	66
I/P Conversion.....	74
I/PsF.....	74
ITU-R BT.709.....	49
ITU-R BT.1886.....	51
ITU-R BT.2020.....	49

L

LAN.....	13
Language	101
LAN (Network/IMD Settings).....	99
Link Order	65
Local Dimming	49
LTC	81
LUT Import	29, 57

M

MAC Address.....	108
Marker Preset.....	76

Marker Settings	76
Marker/TC/CameraInfo Input	66
Monochrome.....	96
Multi View (Dual)	65
Multi View (Quad).....	65

N

Native Input Resolution (Screen Scaling).....	71
Nearest Neighbor	72
Network/IMD Settings	99

O

Offset	56
OSD Brightness.....	102
OSD Menu	22, 41
OSD Position.....	102
OSD Settings.....	102
OSD Size.....	102
Output Transform	54
Output Transform Surround	54
Over Range	95

P

Password	99, 102
Peaking	94
Peak Luminance Control	57
Picture Function Settings.....	94
Picture Mode.....	49, 67
Pixel Value Check	88
PLUGE (Test Pattern).....	88
Power.....	56
Power Indicator Brightness.....	103
Power Indicator/Button LED Settings.....	103
Power on Setting.....	105
Protect Settings.....	102
PsF.....	74

Q

Quad Input	64
------------------	----

R

Ramp (Test Pattern).....	88
Red Off.....	96
Reduce Backlight Flash	104
Reset.....	60
Reset All Settings	105

S

Safety Zone Marker 1, 2	77
-------------------------------	----

Saturation.....	56
Scaling Method	72
Screen Capture	89
Screen Scaling	71
SDI	13, 19
Select Channel	64
Select Input Signal.....	64
Separator	68
Serial No.....	108
Shape Trace	72
Sharpness	49
Signal Information.....	108
Signal Monitoring.....	88
Single Input	64
Single Input Dual View	68
Slope.....	56
SMPTE-C	49
Speed Priority.....	74
Square Division.....	65
Subnet Mask.....	99
System Information.....	108
System Settings	101

T

Test Pattern	88
Time Code	81

U

Usage Time	108
USB	12
User 1-7	49
User LUT	56, 104

V

Vector Scope.....	84
Video Position (Multi View)	72
VITC	81

W

Wave Form Monitor	82
Web	38, 99
White (Test Pattern)	88
Wi-Fi.....	36, 99

Y

YCbCr Color Matrix	58
--------------------------	----

Z

Zoom	73
------------	----

**CANON PROFESSIONAL DISPLAY LIMITED WARRANTY FOR PRODUCTS PURCHASED
IN THE UNITED STATES**

The limited warranty set forth below is given by Canon U.S.A., Inc. ('Canon USA') with respect to Canon Professional Display Equipment (the 'Equipment') accompanying this limited warranty in the Equipment's original container, when purchased in the United States. This limited warranty is only effective upon presentation of your Bill of Sale or other proof of purchase.

Canon USA warrants to the original end-user purchaser, when delivered in new condition in its original container, that the Equipment will be free from defects in materials and workmanship under normal use and service for a period of ONE-YEAR from the date of original purchase. When returning Equipment under this warranty, you must pre-pay the shipping charges, and you must enclose a copy of the Bill of Sale or other proof of purchase with a complete explanation of the problem. Equipment returned to a Canon USA factory service facility, and proven to be defective upon inspection, will be, without charge,:

- (a) repaired utilizing new or comparable refurbished parts, or
- (b) exchanged for refurbished or new Equipment

as determined in the Canon USA's repair facility's sole discretion. The repaired or exchanged Equipment will be shipped back free of charge. Warranty exchange or replacement does not extend the original warranty period of the Equipment. For repairs after the warranty period has expired, an estimate of the cost of repair and an opportunity to approve or reject the repair expense before it is incurred will be provided. If you approve, repairs will be made and the Equipment will be returned at your risk and expense. If you reject, the Equipment will be returned to you at no charge to you to an address within the United States.

This limited warranty only applies if the Equipment is used in conjunction with compatible computer equipment, compatible peripheral equipment and compatible software, as to which items Canon USA will have no responsibility. Canon USA shall have no responsibility under this limited warranty for use of the Equipment in conjunction with incompatible peripheral equipment and/or incompatible software. Non-Canon brand peripheral equipment and software which may be distributed with, or be factory loaded on, the Equipment, are sold 'AS IS' without warranty of any kind by Canon USA, including any implied warranty regarding merchantability or fitness for a particular purpose. The sole warranty with respect to such non-Canon brand items is given by the manufacturer or producer thereof. If the Equipment contains a hard disk drive, Canon USA recommends that data stored on that drive be duplicated or backed up to prevent its loss in the event of failure or other malfunction of such drive.

In order to obtain warranty service, please contact the authorized Canon retail dealer from whom you purchased the Equipment or contact the CANON INFORMATION CENTER AT **855-4K-CANON** (855-452-2666) or on the internet at pro.usa.canon.com/support. You will be directed to the nearest service facility for your Equipment.

Technical support program specifics subject to change without notice.

This Limited Warranty covers all defects encountered in normal use of the Equipment and does not apply in the following cases:

- A. Loss or damage to the Equipment due to abuse, neglect, mishandling, electric current fluctuation, accident, improper maintenance, use of non-Canon accessories or failure to follow operating, maintenance or environmental instructions prescribed in Canon USA's user's manual;
- B. If the Equipment is defective as a result of sand, dirt or water damage;
- C. If defects or damages are caused by the use of parts or supplies (other than those sold by Canon USA) that cause damage to the Equipment or that cause abnormally frequent service calls or service problems;
- D. If defects or damages are caused by service other than Canon USA's factory service centers or authorized service facilities;
- E. Any internal modification to product hardware or firmware;
- F. Any maintenance of the Equipment, including any fees for such Maintenance;
- G. If the Equipment has had its serial number or dating altered or removed.

This Limited Warranty does not apply to Equipment purchased outside the United States. This Limited Warranty does not apply to accessories or consumables for the Equipment, which are sold "AS IS", without warranty of any kind by Canon USA. Please retain this warranty card and your Bill of Sale as a permanent record of your purchase. This card ensures that you are contacted promptly should there be a safety inspection, modification or product recall under applicable laws or regulations. This card ensures that you are contacted promptly should there be a safety inspection, modification or product recall under applicable laws or regulations.

NO IMPLIED WARRANTY, INCLUDING MERCHANTABILITY AND FITNESS FOR A PARTICULAR PURPOSE APPLIES TO THIS EQUIPMENT AFTER THE APPLICABLE PERIOD OF EXPRESS WARRANTY OR GUARANTY UNDER THIS WARRANTY (EXCEPT AS MENTIONED ABOVE). (SOME STATES DO NOT ALLOW LIMITATIONS ON HOW LONG AN IMPLIED WARRANTY LASTS, SO THE ABOVE LIMITATION OR EXCLUSION MAY NOT APPLY TO YOU). CANON USA SHALL NOT BE LIABLE FOR LOSS OF REVENUES OR PROFITS, EXPENSE FOR SUBSTITUTE EQUIPMENT OR SERVICE, STORAGE CHARGES, LOSS OR CORRUPTION OF DATA, INCLUDING WITHOUT LIMITATION, LOSS OR CORRUPTION OF DATA STORED ON THE EQUIPMENT'S HARD DRIVE, OR ANY OTHER SPECIAL, INCIDENTAL OR CONSEQUENTIAL DAMAGES CAUSED BY THE USE, MISUSE OR INABILITY TO USE THE EQUIPMENT, REGARDLESS OF THE LEGAL THEORY ON WHICH THE CLAIM IS BASED, AND EVEN IF CANON USA HAS BEEN ADVISED OF THE POSSIBILITY OF SUCH DAMAGES. NOR SHALL RECOVERY OF ANY KIND AGAINST CANON USA BE GREATER THAN THE PURCHASE PRICE OF THE EQUIPMENT SOLD BY CANON USA AND CAUSING THE ALLEGED DAMAGE. WITHOUT LIMITING THE FOREGOING, YOU ASSUME ALL RISK AND LIABILITY FOR LOSS, DAMAGE OR INJURY TO YOU AND YOUR PROPERTY AND TO OTHERS AND THEIR PROPERTY ARISING OUT OF USE, MISUSE OR INABILITY TO USE THE EQUIPMENT NOT CAUSED DIRECTLY BY THE NEGLIGENCE OF CANON USA (SOME STATES DO NOT ALLOW THE EXCLUSION OR LIMITATION OF INCIDENTAL OR CONSEQUENTIAL DAMAGES, SO THE ABOVE LIMITATION MAY NOT APPLY TO YOU). THIS WARRANTY SHALL NOT EXTEND TO ANYONE OTHER THAN THE ORIGINAL PURCHASER OF THIS EQUIPMENT OR THE PERSON FOR WHOM IT WAS PURCHASED AS A GIFT.

This warranty gives you specific legal rights, and you may also have other rights which vary from state to state.

CANON U.S.A., INC

CANON PROFESSIONAL DISPLAY LIMITED WARRANTY FOR PRODUCTS PURCHASED IN CANADA

The limited warranty set forth below is given by Canon Canada Inc. ('Canon Canada') with respect to Canon Professional Display Equipment (the 'Equipment') accompanying this limited warranty in the Equipment's original container, when purchased in Canada. This limited warranty is only effective upon presentation of your bill of sale or other proof of purchase.

Canon Canada warrants to the original end-user purchaser, when delivered in new condition in its original container, that the Equipment will be free from defects in materials and workmanship under normal use and service for a period of ONE YEAR from the date of original purchase. When returning Equipment under this limited warranty, you must pre-pay the shipping charges, and you must enclose a copy of the bill of sale or other proof of purchase with a complete explanation of the problem. Equipment returned to a Canon Canada factory service facility and proven to be defective upon inspection will be, without charge:

- (a) repaired utilizing new or comparable refurbished parts, or
- (b) exchanged for refurbished or new Equipment,

as determined by the Canon Canada factory service center, in its sole discretion. The repaired or exchanged Equipment will be shipped back free of charge. Warranty exchange or replacement does not extend the original warranty period of the Equipment. For repairs after the warranty period has expired, an estimate of the cost of repair and an opportunity to approve or reject the repair expense before it is incurred will be provided. If you approve the proposed repairs, repairs will be made and the Equipment will be returned at your risk and expense. If you reject the proposed repairs, the Equipment will be returned to you at no charge to you to an address within Canada.

This limited warranty only applies if the Equipment is used in conjunction with compatible computer equipment, compatible peripheral equipment and compatible software, as to which items Canon Canada will have no responsibility. Canon Canada shall have no responsibility under this limited warranty for use of the Equipment in conjunction with incompatible computer equipment, peripheral equipment and/or incompatible software. Non-Canon brand peripheral equipment and software which may be distributed with, or be factory loaded on, the Equipment, are sold 'AS IS' without warranty or condition of any kind by Canon Canada, including any implied warranty or condition regarding merchantability or fitness for a particular purpose. The sole warranty with respect to such non-Canon brand items is given by the manufacturer or producer thereof. If the Equipment contains a hard disk drive, Canon Canada recommends that data stored on that drive be duplicated or backed up to prevent its loss in the event of failure or other malfunction of such drive.

In order to obtain warranty service, please contact the authorized Canon retail dealer from whom you purchased the Equipment or contact the CANON INFORMATION CENTER at **800-667-2666** or on the internet at www.canon.ca/pro.

Technical support program specifics are subject to change without notice.

This limited warranty covers all defects encountered in normal use of the Equipment and does not apply in the following cases:

- A. Loss or damage to the Equipment due to abuse, neglect, mishandling, electric current fluctuation, accident, improper maintenance, use of non-Canon accessories or failure to follow operating, maintenance or environmental instructions prescribed in Canon Canada's users manual;
- B. If the Equipment is defective as a result of sand, dirt or water damage;
- C. If defects or damages are caused by the use of parts or supplies (other than those sold by Canon Canada) that cause damage to the Equipment or that cause abnormally frequent service calls or service problems
- D. If defects or damages are caused by service other than Canon Canada's factory service centers or authorized service facilities;
- E. Any internal modification to product hardware or firmware;
- F. Any maintenance of the Equipment, including any fees for such maintenance; or
- G. If the Equipment has had its serial number or dating altered or removed.

This limited warranty does not apply to Equipment purchased outside Canada. This limited warranty does not apply to accessories or consumables for the Equipment, which are sold "AS IS", without warranty or condition of any kind by Canon Canada. Please retain this warranty card and your bill of sale or other proof of purchase as a permanent record of your purchase. This card ensures that you are contacted promptly should there be a safety inspection, modification or product recall under applicable laws or regulations.

NO IMPLIED WARRANTY OR CONDITION, INCLUDING IN RESPECT OF THE MERCHANTABILITY AND FITNESS FOR A PARTICULAR PURPOSE, APPLIES TO THIS EQUIPMENT AFTER THE EXPIRATION OF THE APPLICABLE PERIOD OF EXPRESS WARRANTY OR GUARANTEE UNDER THIS LIMITED WARRANTY (EXCEPT AS MENTIONED ABOVE). (SOME PROVINCES DO NOT ALLOW LIMITATIONS ON HOW LONG AN IMPLIED WARRANTY LASTS, SO THE ABOVE LIMITATION OR EXCLUSION MAY NOT APPLY TO YOU). CANON CANADA SHALL NOT BE LIABLE FOR LOSS OF REVENUES OR PROFITS, EXPENSE FOR SUBSTITUTE EQUIPMENT OR SERVICE, STORAGE CHARGES, LOSS OR CORRUPTION OF DATA, INCLUDING WITHOUT LIMITATION, LOSS OR CORRUPTION OF DATA STORED ON THE EQUIPMENT'S HARD DRIVE, OR ANY OTHER SPECIAL, INCIDENTAL OR CONSEQUENTIAL DAMAGES CAUSED BY THE USE, MISUSE OR INABILITY TO USE THE EQUIPMENT, REGARDLESS OF THE LEGAL THEORY ON WHICH THE CLAIM IS BASED, AND EVEN IF CANON CANADA HAS BEEN ADVISED OF THE POSSIBILITY OF SUCH DAMAGES. NOR SHALL RECOVERY OF ANY KIND AGAINST CANON CANADA BE GREATER THAN THE PURCHASE PRICE OF THE EQUIPMENT SOLD BY CANON CANADA AND CAUSING THE ALLEGED DAMAGE. WITHOUT LIMITING THE FOREGOING, YOU ASSUME ALL RISK AND LIABILITY FOR LOSS, DAMAGE OR INJURY TO YOU AND YOUR PROPERTY AND TO OTHERS AND THEIR PROPERTY ARISING OUT OF USE, MISUSE OR INABILITY TO USE THE EQUIPMENT NOT CAUSED DIRECTLY BY THE NEGLIGENCE OF CANON CANADA (SOME PROVINCES DO NOT ALLOW THE EXCLUSION OR LIMITATION OF INCIDENTAL OR CONSEQUENTIAL DAMAGES, SO THE ABOVE LIMITATION MAY NOT APPLY TO YOU). THIS LIMITED WARRANTY SHALL NOT EXTEND TO ANYONE OTHER THAN THE ORIGINAL PURCHASER OF THIS EQUIPMENT OR THE PERSON FOR WHOM IT WAS PURCHASED AS A GIFT.

This limited warranty gives you specific legal rights, and you may also have other rights which vary from province to province.

CANON CANADA INC.



Canon Inc. 30-2, Shimomaruko 3-chome, Ohta-ku, Tokyo 146-8501, Japan

AUSTRALIA www.canon.com.au

Canon Australia Pty Ltd

☎ 13-13-83 (within Australia only)

☎ (61) 02-9805-2000

CANADA

CANON CANADA INC.

<http://www.canon.ca>

❖ Professional Product Support / Soutien des produits professionnels

☎ (800) 667-2666

CENTRO Y SURAMÉRICA

CANON U.S.A. - Latin America Group

<http://www.cla.canon.com>

EUROPE www.canon-europa.com

Canon Europa N.V.

Bovenkerkerweg 59,

1185 XB Amstelveen, The Netherlands

MÉXICO

CANON MEXICANA, S DE RL DE CV

<http://www.canon.com.mx>

☎ 52 (55) 5249-4905

NEW ZEALAND www.canon.co.nz

Canon New Zealand Ltd

☎ 0800-222-666 (within New Zealand only)

☎ (64) 09-489-0300

UNITED KINGDOM www.canon.co.uk

Canon UK Ltd

CCI Service Centre, Unit 130, Centennial Park,
Borehamwood, Hertfordshire, WD6 3SE

☎ 0844-369-0100

USA

CANON U.S.A., INC.

<http://pro.usa.canon.com>

<http://pro.usa.canon.com/support>

☎ (855) 4K-CANON (855-452-2666)
(USA only)

캐논코리아컨슈머이미징㈜

<http://www.canon-ci.co.kr>

서울특별시 강남구 테헤란로607, 캐논빌딩 5층
대표전화+82(0)2-1588-8133

Canon Korea Consumer Imaging Inc.

<http://www.canon-ci.co.kr>

5F, Canon Bldg, 607, Teheran-ro, Gangnam-gu,
Seoul, Korea

☎ +82(0)2-1588-8133

Visit your local Canon Web site to download the latest version of this instruction manual.