

# CONTEXT 2

## Owner's Manual

# CONTEXT 2

## Owner's Manual

For firmware 2.2.2 and later  
November 2021

Red Panda LLC  
44712 Helm St  
Plymouth, MI 48170  
USA

©2020-2021 Red Panda LLC  
[www.redpandalab.com](http://www.redpandalab.com)

Please register your product at [redpandalab.com/register](https://redpandalab.com/register)

Product manuals and firmware updates are available at [redpandalab.com/downloads](https://redpandalab.com/downloads)

For technical support, email [support@redpandalab.com](mailto:support@redpandalab.com)

# Contents

<b>Introduction</b>	<b>5</b>
<b>Signal Flow</b>	<b>6</b>
<b>Getting Started</b>	<b>7</b>
<b>Inputs and Outputs</b>	<b>8</b>
<b>Controls</b>	<b>10</b>
<b>Reverb Algorithms</b>	<b>12</b>
<b>Bypass</b>	<b>13</b>
<b>Trails</b>	<b>13</b>
<b>Reverb Hold (<math>\infty</math>)</b>	<b>13</b>
<b>Drone Mode</b>	<b>14</b>
<b>HI / LO Response</b>	<b>14</b>
<b>Tremolo (Spring Only)</b>	<b>15</b>
<b>Dynamics</b>	<b>15</b>
<b>Delay</b>	<b>18</b>
<b>Presets</b>	<b>18</b>
<b>Control Input</b>	<b>19</b>
<b>Tap Tempo</b>	<b>21</b>
<b>Using MIDI</b>	<b>22</b>
<b>Reset to Factory Defaults</b>	<b>25</b>
<b>Web Editor</b>	<b>33</b>
<b>Support and Repairs</b>	<b>36</b>
<b>Warranty</b>	<b>37</b>
<b>Firmware Updates</b>	<b>38</b>
<b>Specifications</b>	<b>39</b>
<b>Credits</b>	<b>39</b>

# Introduction

Thank you for purchasing the Context 2. The Context is an algorithmic reverb inspired by 1980's rack-mount digital reverbs. Those reverbs used specialized processors with limited precision. The Context 2 uses a high-performance processor with 32/64-bit floating-point processing at 48 kHz. It combines classic reverb algorithm design with modern digital signal processing techniques.

## **New in Version 2**

The Context 2 uses a much more powerful processor than the original Context, allowing it to run two reverb engines simultaneously so that you can change presets with spillover. Holding down either of the footswitches will sustain the reverb indefinitely (reverb freeze).

Some of the improvements include:

- Spring reverb algorithm with tremolo
- Reverse reverb algorithm
- Granular reverb algorithm inspired by the Ursa Major SST-282 Space Station
- Delay plus reverb in all modes
- Plate algorithm has predelay
- Adjustable modulation in all algorithms
- Low and high frequency damping in all modes
- More control over low and high frequency damping response
- Dynamic reverb for ducking or expansion
- Adjustable input and output levels
- Tap tempo with independent note divisions for delay, predelay, and tremolo rate (requires external switch)
- Independent note divisions for delay time, reverb predelay, and tremolo speed
- Reverb hold/freeze, with live signal dry or effected
- Smaller enclosure, with all jacks on top
- Stereo (TRS) input/output
- Assignable expression pedal
- Presets (1 on front panel, 4 via remote switch, 126 via MIDI)
- Soft touch switches
- Momentary/latching footswitch action
- Higher sampling rate
- Higher headroom
- Better signal-to-noise ratio
- Full MIDI control via USB or 1/4" TRS
- Multi-purpose control port for expression pedal, CV, remote switches, tap tempo, and MIDI
- USB firmware updates
- Web-based editor (requires Chrome)

# Signal Flow

Red Panda Context 2 Signal Path

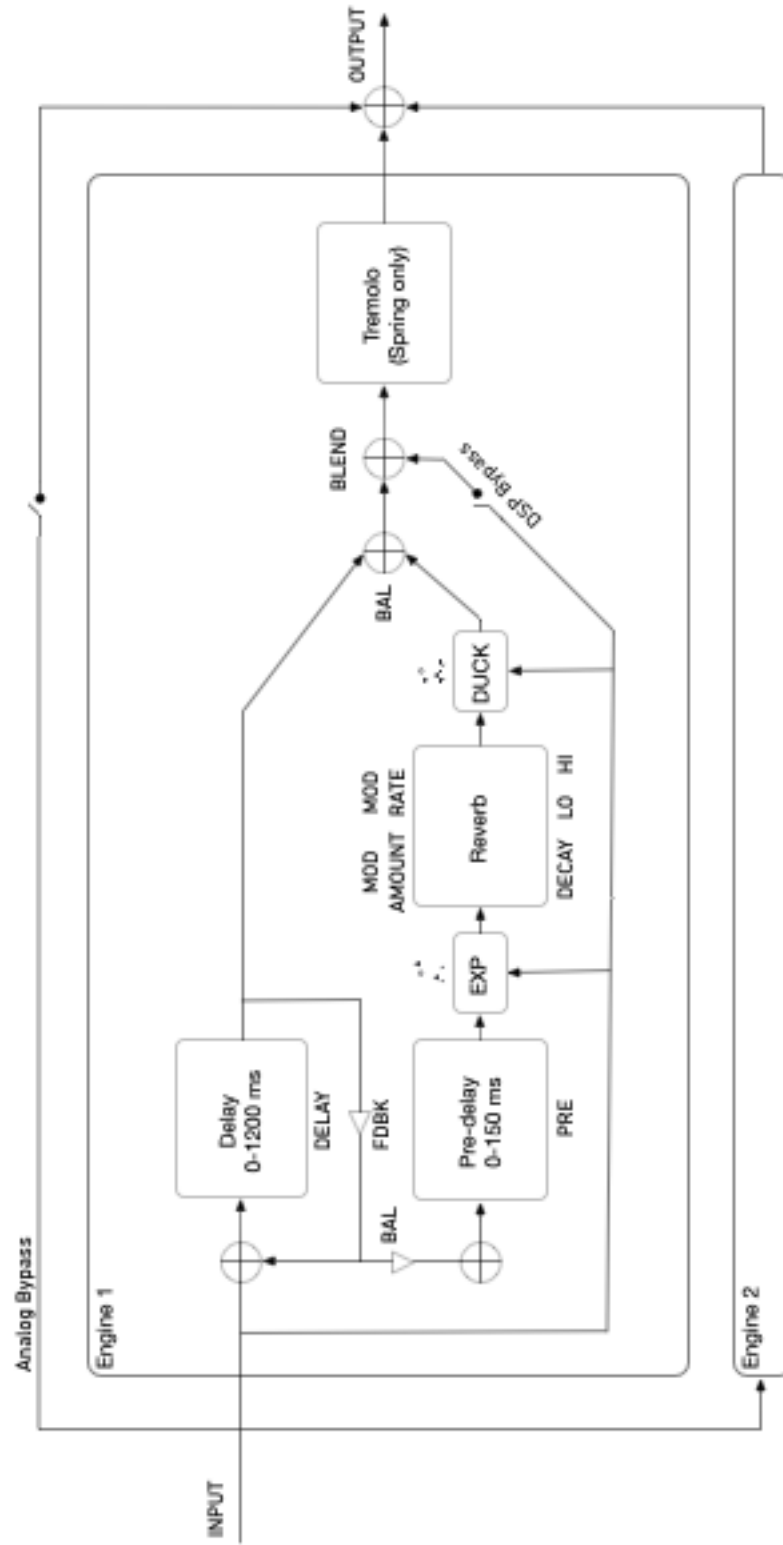

# Getting Started

Connect the input and output using 1/4" TS cables (for mono) or TRS cables (for stereo). When using TRS cables, the left channel is on the tip and the right channel is on the ring.

Plug in a 9V DC regulated power supply rated at 250 mA or more. If the pedal's LED turns magenta and it switches to bypass mode, that means it detected a problem with the power supply. The most common problem is that the power supply is not providing enough current. See our [knowledge base](#) for information about specific power supplies.

To begin, you can ignore the "shift" parameters and treat the Context as a two-knob reverb. Start with these settings:

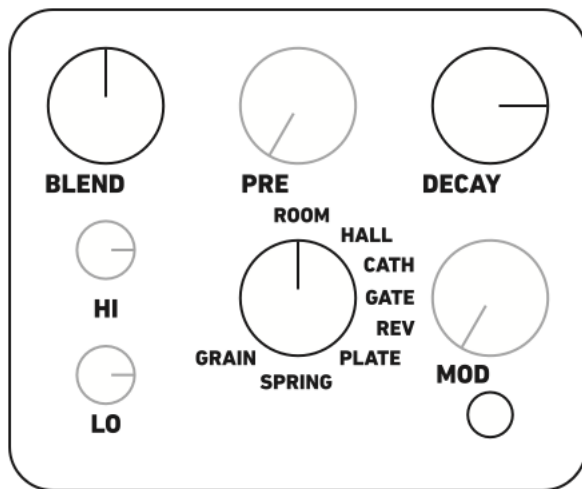

**BLEND** controls the wet/dry blend, Set it to 12:00 (50/50).  
**PRE** (pre-delay) sets a delay before the initial reverb sound. Set it to 7:00 so that the reverb starts immediately.  
**DECAY** sets the reverb decay time. Set it to 3:00 to hear the difference between the algorithm tails.  
**MOD** (modulation) sets the amount and character of modulation. Set it to 7:00 (off) for now.  
**HI** sets the high-frequency response. Set it to 3:00 for a bright reverb.  
**LO** sets the low-frequency response. Set it to 3:00 for a full-spectrum reverb.  
Start by selecting the **ROOM** algorithm.

These settings can be used as a starting point when designing a reverb sound. Cycle through each of the reverb algorithms and note the differences in how fast the reverb builds up and how the sound changes as it decays.

Next adjust the **MOD** knob with different reverb algorithms. The **MOD** knob adjusts the amount and character of the modulation. It behaves different in different modes. For ROOM, HALL, CATHEDRAL, and PLATE, the modulation morphs from random chorus modulation at lower settings, to a pitch-stable random modulation, then a deep chorus modulation. For REV (reverse) reverb, it adds a wash of regular reverb. For SPRING reverb, it sets the tremolo depth.

The **HI** and **LO** controls adjust high- and low-frequency damping and response. Both knobs at 3:00 PM gives a full-spectrum reverb, with low and high boost at higher settings. At low settings, the reverb bandwidth is reduced.

## Web Editor

We provide a web-based editor to configure your Context, access hidden parameters, and fine-tune presets. See "Web Editor (beta)" on page 33 for more information.. It requires the Google Chrome browser, and can be accessed at

<https://www.redpandalab.com/content/apps/context-editor/index.html>

Note the "https" URL protocol. "http" will not allow Chrome to access MIDI devices.

# Inputs and Outputs

DC POWER	Connect a 9V DC center negative power supply rated at 250 mA or higher.
USB	USB mini B connector for MIDI, web editor, and firmware updates.
IN	1/4" TRS mono or stereo input.
CTRL	1/4" TRS jack for expression pedal, remote, or MIDI.
OUT	1/4" TRS mono or stereo output.

The Context supports multiple input and output configurations, bypass modes, and signal levels. These can be configured using our web editor, or by sending MIDI System Exclusive strings.

The default configuration is mono in / stereo out with DSP bypass and trails, with a maximum signal level of +5 dBu, which works well in most situations.

## Power

Use a 9V center negative (Boss-style) regulated power supply that can provide 250 mA or more of current. The plug should have 2.1mm inside diameter and 5.5mm outside diameter. This is the type of power supply used by almost all guitar pedals, and we recommend using one designed specifically for effects. If you have a few pedals, we recommend a multi-pedal power supply with independent regulated outputs (not daisy chained).

If our pedals detect a problem with the power supply, the bypass LED will change to magenta (or pink), the pedal will switch to bypass and enter a low power mode. After a few seconds, the pedal will restart. The most common reasons are that the power supply is not providing enough current, or it is an unregulated voltage converter. Note that some multi-pedal supplies are rated at 100 mA except for a couple of high-current outputs. Some multi-pedal power supplies also share current across multiple outputs. You need to make sure the total current required for all connected pedals is within the power supply's limits.

For additional information, please see our [knowledge base](#).

## Input/Output Configuration

Mono in / mono out	Input and output use 1/4" TS (mono) plugs.
Mono in / stereo out (default)	Input uses 1/4" TS plug. Output uses 1/4" TRS plug with left signal on tip, right on ring.
Stereo in / stereo out	Input uses 1/4" TRS plug with left signal on tip, right on ring. Output uses 1/4" TRS plug with left signal on tip, right on ring.



## Maximum Input Level

Mode	Max. Signal Level (Volts peak-to-peak)	Description
+12 dB with -3 dB pad	8.2 Vpp	For extremely hot input signals. DSP output will be reduced by -3 dB. Analog bypass signal is not affected (so DSP bypass or kill dry work best).
+8 dB	5.7 Vpp	Works well with synthesizers.
+5 dB (default)	4 Vpp	Works with most instrument and line-level signals.
0 dB	2.3 Vpp	Acoustic guitar and quiet instruments.

The right LED blinks red if input clipping occurs. Lower the output volume of your instrument or select a higher maximum input level. Clipping will not damage the pedal, so you can also overload the A/D converter to intentionally add distortion.

The output signal level can be slightly higher than the maximum input level, which allows the combined dry and effected signals to exceed the input level without distortion.

## Bypass Mode

DSP (default)	Dry signal and bypass passes through DSP. Our pedals use studio-quality A/D and D/A converters with low latency. This is a good choice in most situations.
Analog	Dry signal passes through DSP when effect is on, and buffered analog signal path in bypass. Depending on the input signal, there could be a small click when the effect is engaged.
Analog + FX Level	Dry signal passes through a unity-gain analog signal path.
Kill Dry	Dry signal is always muted. Useful for wet/dry parallel effects chains and mixer aux sends. The <b>BLEND</b> knob acts as an effect level control, but keeps the same response as other modes.

Analog + FX Level bypass mode is not compatible with Mono In / Stereo Out, because the analog signal path cannot send the left input to both output channels. A workaround is to use a female TS to male TRS mono to stereo adapter to split the mono input signal to both channels, with Stereo In/Stereo Out configuration.

## Trails

OFF	Reverb tail fades out immediately when effect is turned off.
ON	Reverb tail decays naturally after effect is turned off.

# Controls

Each knob on the Context has a primary and secondary function.

## Editing Alternate Controls [SHIFT]

Press and hold the **[SHIFT]** button to adjust alternate parameters shown in light blue. Settings are stored in presets and remembered when the pedal is turned off. Alternate functions are labeled **[SHIFT]** in the following sections.

When shift mode is on, the right LED changes from blue to cyan and the left LED indicates whether the input signal is above the dynamics threshold:

Off - signal is below -48 dBFS.

Green - signal level is below threshold

Yellow - signal level is at threshold

Red - signal level is above threshold

To edit **[SHIFT]** settings:

1. Hold the **[SHIFT]** button until the LED changes to cyan
2. While holding the **[SHIFT]** button, adjust the knobs and mode switch as desired
3. Release the **[SHIFT]** button to store the setting

Double click the **[SHIFT]** button to enable shift lock. The knobs now adjust alternate parameters until the **[SHIFT]** button is pressed again:

1. Double click the **[SHIFT]** button. The LED will change to cyan and blink blue to indicate that shift lock mode is engaged.
2. Adjust the knobs and mode switch as desired
3. Press the **[SHIFT]** button to store the setting and exit shift lock mode

## BLEND / [BAL]

Adjusts the wet/dry mix, from 100% dry to 100% wet.

**[SHIFT]-BAL** sets the balance between reverb and delay. Note that if **DELAY** and **FDBK** are both set to 0, the delay is off and **BAL** will have no effect (100% reverb).

## PRE / [DELAY]

Adjusts the predelay (0-150 ms).

**[SHIFT]-DELAY** adjusts the delay time (0-1200 ms). Setting both **DELAY** and **FDBK** to 0 will turn off the delay.

## DECAY / [FDBK]

Adjusts the reverb decay time.

**[SHIFT]-FDBK** adjusts the delay feedback. Setting both **DELAY** and **FDBK** to 0 will turn off the delay.

## **MOD / [RATE]**

Adjusts reverb modulation amount and character.

REV: adds forward reverb.

SPRING: tremolo depth.

**[SHIFT]** Adjusts modulation speed.

## **HI / [DYNAMICS RECOVERY TIME]**

High-frequency response. Reverb damping is increased as knob is turned down. Flat at 3:00.

**[SHIFT]** Dynamics recovering time. Center position is off. Turning the knob farther from the center position will lengthen the time it takes for the reverb level to recover.

Left: ducking

Center: off

Right: expander

## **LO / [DYNAMICS THRESHOLD]**

Low-frequency response. Reverb damping is increased as knob is turned down. Flat at 3:00.

**[SHIFT]** adjusts dynamics threshold.

# Reverb Algorithms

## **ROOM**

Fast build-up with multiple initial reflections.

## **HALL**

Emulates a concert hall. Slow build-up with a longer initial delay.

## **CATHEDRAL**

Emulates a large, reflective space.

## **GATED**

Gated reverb with nonlinear decay. Known for big drum sounds, gated reverb also works well on guitar because you can add more reverb while keeping transparency and space between notes.

## **REVERSE**

Reverse reverb. Reflections get louder and brighter as time passes, giving the impression that the signal is played backwards. Typically used with 100% wet signal.

Modulation knob adds a wash of forward reverb.

## **PLATE**

Emulates studio plate reverbs, which use plates of thin sheet metal to create reflections. Bright and dense sound, good for drums, guitar, and vocals.

Modulation adds rich stereo chorusing. For more "bend", increase the modulation rate to approximately 1:30.

## **SPRING**

Spring reverb. It is not a model of a specific spring reverb. The Context 2 simulates a spring reverb using the algorithms and techniques used in 1980's reverbs, but with more processing power available.

Low decay settings work well for vocals, bass, and adding subtle ambience to your instrument without an obvious reverb effect. Middle settings match spring reverb settings on guitar amplifiers. At higher decay settings, the decay time is extended and it starts to sound a little unnatural.

## **GRAIN**

A granular reverb with some similarities to the Ursa Major SST-282 Space Station. With mod knob at zero, it sounds like a modulated multi-tap delay. With low modulation, long decays become ghostly voices. As the mod knob increases, the character of the modulation changes and then the sound begins to pull apart.

The Ursa Major SST-282 Space Station, released in 1978, was an effects processor that used a single delay line with modulated taps to create reverb effects. The Context 2 can produce the same kind of ghostly reverb effects, but is not a direct model.

## Bypass

The right footswitch turns the effect on and off. Tap to toggle between bypass and effect. Press and hold the right footswitch to turn on the effect in momentary mode - it will return to bypass when the footswitch is released.

The Context remembers its bypass state when power is removed.

Hold down the right footswitch while plugging an expression pedal, CV cable, or remote switch into the **CTRL** port to configure the port. See "Control Input" on page 19 for details.

## Trails

Reverb trails can be turned on/off globally, or per preset. The right LED blinks green on startup to indicate whether trails are on or off:

- 2 long blinks: trails off
- 4 short blinks: trails on

Hold down the SHIFT button and press the ON footswitch ([SHIFT]-ON) to toggle the global trails setting on or off.

Trails can be turned on or off at the preset level using our web-based editor. By default, presets use the global trails setting.

## Reverb Hold ( $\infty$ )

Holding either footswitch will indefinitely hold (freeze) the reverb signal. Releasing the footswitch will cause the reverb signal to decay naturally.

The left footswitch freezes the current reverb sound and plays your live signal through the other reverb engine - either the preset sound or live knob settings. Adjusting controls will affect the live reverb, while the frozen reverb will remain the same. When the footswitch is released, the live signal will go back to the original (held) reverb.

The right footswitch freeze mode is configurable using the web editor or MIDI:

Freeze + Live Dry	The current reverb is frozen and the live signal is dry. Knob movements affect the frozen reverb, so you can adjust modulation and EQ.  If you move the reverb algorithm knob, the live signal will switch to the selected reverb algorithm and the frozen reverb will remain the same.
Freeze + Live Reverb	The current reverb is frozen and the live signal is played through the same reverb (using a different reverb engine). Knob movements will affect the live reverb.
Infinite Sustain	The current reverb is held with the input still active, causing sound to build up.

Different textures can be achieved by adjusting the EQ, decay, and modulation rate/depth controls.

Infinite sustain will build up to saturation, creating a noisy, distorted, modulated texture. Each reverb algorithm sounds different, and they can be shaped using modulation and EQ. When the footswitch is released, the reverb will decay out naturally.

Using dynamic ducking infinite sustain will allow new notes to enter the reverb, while ducking the reverb output so that the notes are audible. Expansion will emphasize louder notes and de-emphasize quiet notes. See "Dynamics" on page 15 for more information.

## Drone Mode

The **SHIFT** button can be used to lock on reverb hold, creating an atmospheric drone. This works with any of the reverb hold modes:

1. Press and hold the **PRESET**/ $[\infty]$  or **ON**/ $[\infty]$  footswitch to engage reverb hold.
2. Press and hold the **SHIFT** button.
3. Release the **PRESET**/ $[\infty]$  or **ON**/ $[\infty]$  footswitch.
4. Release the **SHIFT** button.

To turn off drone mode, press the same footswitch once.

## HI / LO Response

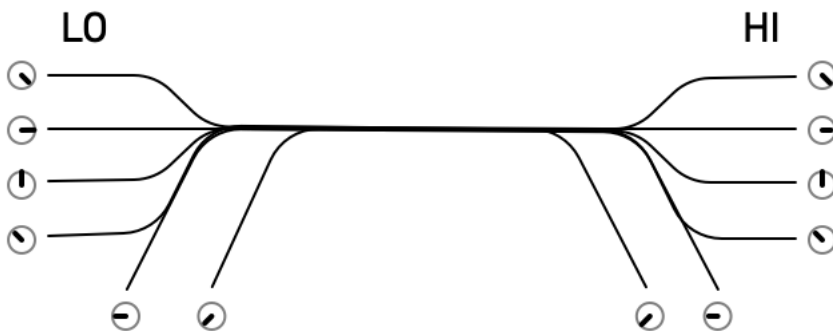

The **HI** and **LO** controls adjust the high- and low-frequency response of the reverb, respectively. This is also known as reverb damping. 3:00 is flat, as shown in the diagram below.

From approximately 5:00 to 9:00, the **LO** control acts as a highpass filter and the **HI** control acts as a lowpass filter. As the knobs are turned clockwise, the cutoff frequency moves lower and higher, respectively. So the reverb starts out with a narrow frequency band and then opens up.

Above 9:00, the controls act as shelving filters to adjust the high- and low-frequency decay of the reverb. Above 3:00, there is a slight boost. From 9:00-3:00, the **HI** knob approximately matches the response of the Context 1 **damping** control, except that the direction is reversed.

Turning the **LO** control down can help prevent the reverb from sounding muddy with low-frequency signals, or create a thin and "airy" reverb sound.

Turning the **HI** control down creates a darker reverb. Boosting the high frequencies will add presence.

## Tremolo (Spring Only)

Tremolo varies the volume of your signal in a rhythmic pattern. The Context 2 tremolo affects the volume of the wet and dry signal after the reverb. The **MOD** control adjusts the tremolo depth, from off to subtle sine wave to choppy near-square-wave tremolo. The **RATE** control adjusts the tremolo speed, which can also be synced to a note division.

The tremolo is implemented digitally, so it will not affect the dry signal volume when using **Analog + FX Level** bypass mode.

## Dynamics

While holding down the **[SHIFT]** button (or SHIFT LOCK), the **HI** and **LO** knobs adjust reverb dynamics - How the reverb level responds to your playing level. The **LO** knob adjusts how it responds to level, and the **HI** knob adjusts the time response.

The threshold control (**[SHIFT]-LO**) sets the signal level at which the dynamics kick in. While in **SHIFT** mode, the left LED changes color to indicate the signal level relative to the threshold:

Off - signal is below -48 dBFS.

Green - signal level is below threshold

Yellow - signal level is at threshold

Red - signal level is above threshold

The threshold control should be adjusted based on your playing dynamics, signal level, and desired effect. It may need to be adjusted if you change your instrument, pickup, or signal path.

The release control (**[SHIFT]-HI**) turns off dynamics at 12:00.

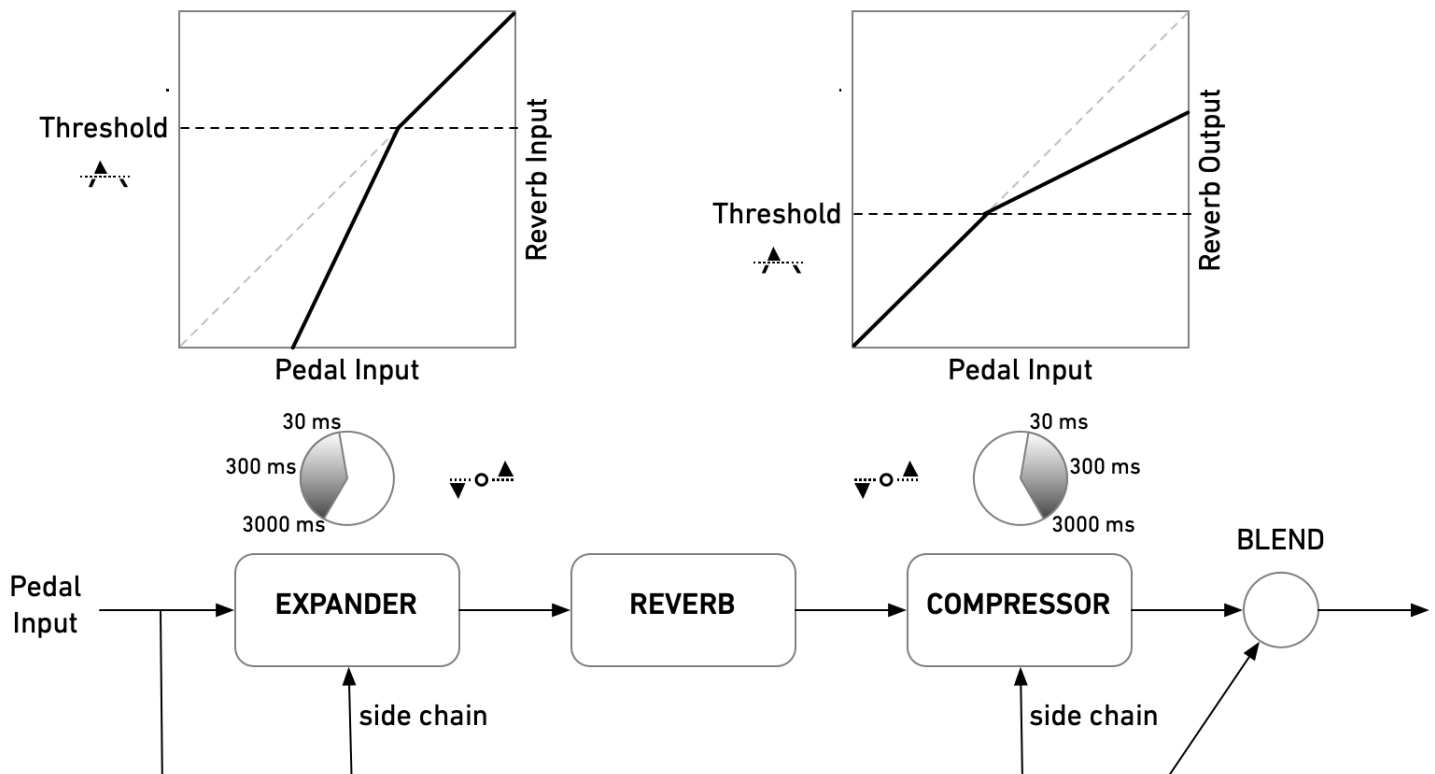

## Ducking (below 12:00)

When the signal level exceeds the threshold, the reverb signal is attenuated. The reverb "ducks" below loud notes, and comes back as the note decays. Quiet notes have more reverb, and loud notes have less.

The release (**[SHIFT]-HI**) control sets the amount of time it takes for the reverb signal to recover, increasing counter-clockwise from 12:00. The range is 30 - 3000 ms.

## Expansion (above 12:00)

When the signal level drops below the threshold, the reverb input signal is attenuated. Loud notes have full reverb, notes below the threshold have less reverb. Since the dynamic range expansion happens on the input to the reverb engine, loud notes will trail off and will not affect the trails of quieter notes.

The release (**SHIFT-HI**) control sets the amount of time it takes for the reverb input signal to recover, increasing clockwise from 12:00. The range is 30 - 3000 ms.

## Dynamic reverb techniques

To get a feel for how it works, set the release (**[SHIFT]-HI**) control to 11:00 (ducking) or 1:00 (expansion) to give the most dramatic effect. Adjust the threshold so that the LED blinks red on moderately loud notes. Then play a crescendo from very soft to very loud to see how the reverb level changes. Setting the **BLEND** to 100% wet will make the volume difference more apparent.

Use reverb ducking to increase clarity by reducing the reverb level during your instrument's attack or while playing loud. Adjust the release time to the fastest setting that avoids audible "pumping" when the reverb comes back up.



Use reverb expansion with a quick release to create unnatural reverb tails. Set the threshold right below the point where the LED blinks red on note attacks. As notes decay, the reverb level will fall off more rapidly.

Use expansion to emphasize loud chords, while applying more subtle reverb to melodies. Set the threshold so that the LED is red during loud passages and green during quiet passages. The release time controls how tightly it tracks your playing, and the reverb decay controls how long it lingers.

Use a volume pedal, volume knob, or pickup selector switch to move above and below the threshold, putting a compressor after the Context to smooth out volume differences.

## Delay

Context 2 has delay available in all modes. Each reverb engine has its own stereo delay line. The input signal is fed into both the delay and reverb. The delay feedback signal is also fed into the reverb.

The **DELAY ([SHIFT]-PRE)** control sets the delay time and the **FDBK ([SHIFT]-DECAY)** control sets the feedback amount. This allows you to set a single repeat or to use feedback to create resonant or flanged reverb sounds. There is a minimum delay time when feedback is used. Set *both* **DELAY** and **FDBK** to zero to turn off the delay.

The **BAL** (balance) control adjusts the balance from 100% reverb to 100% delay. When set to 100% reverb (7:00), the delay is disabled. When set to 100% delay (5:00), the Context functions as a delay pedal.

The **HI** and **LO** controls do not affect the tone of the delay.

## Presets

The Context stores 127 presets (MIDI program number 0-126). The left footswitch toggles between the live settings and the active preset with spillover - the previous reverb setting will trail off naturally. This allows you to have two separate reverb settings available, for example, one for the verse and one for the chorus.

Adjusting controls while a preset is active will alter the sound. The preset is reset to its saved settings each time the **PRESET** button is pressed, unless you save the new sound.

All presets are accessible via MIDI program change messages. MIDI program 127 resets the parameters to the current knob settings. (Note that some controllers label MIDI programs 0-127 and some use 1-128.)

### Changing the Active Preset

Send a MIDI program change message. The preset will immediately be selected, and the previous reverb setting will decay naturally (spillover).

### Saving a Preset

To save preset 0, adjust the live settings for the desired sound, then hold down the **[SHIFT]** button and press the left footswitch. The right LED will blink green to acknowledge that the preset was saved.

To save any preset (0-126) via MIDI, send a MIDI program change message while holding down the **[SHIFT]** button. You can also save a preset using a MIDI System Exclusive message (See "System Exclusive (SysEx)" on page 29).

# Control Input

The **CTRL** (control) input supports different methods of remotely controlling the pedal:

- Expression pedal
- Control voltage (CV) with 0-3.3V range
- Tap Tempo
- TRS MIDI in (tip active)
- Remote switch

To configure an expression pedal or remote switch, hold down the right footswitch while plugging it in. The pedal will detect which device is connected using the steps below. You can also use our web editor to configure the port.

The configuration is remembered when power is turned off. Expression pedal assignments and remote switch settings are stored in presets and remembered when power is turned off.

## Expression Pedal

An expression pedal can be assigned to any combination of knob settings at the heel and toe position (up to 6 parameters). Moving the expression pedal will morph between the settings.

You can also calibrate the range of the expression pedal, to ensure that its full travel is used.

### Calibrating Expression Pedal Range (no knob assignments):

1. Start with the pedal powered on and nothing plugged into the **CTRL** port.
2. Hold the right footswitch while plugging in the expression pedal. The right LED will blink yellow three times to indicate it is in **CTRL** configuration mode. You can release the right footswitch and begin configuration immediately.
3. Move the expression pedal to the heel down position.
4. Move the expression pedal to the toe down position.
5. Hold the right footswitch for 3 seconds to save the configuration. The right LED will blink green to indicate that the configuration has been saved.

### Configuring Expression Pedal Knob Assignments

1. Start with the pedal powered on and nothing plugged into the **CTRL** port.
2. Hold the right footswitch while plugging in the expression pedal. The right LED will blink yellow 3 times to indicate it is in **CTRL** configuration mode. You can release the right footswitch and begin configuration immediately.
3. Move the expression pedal to the heel down position.
4. Adjust the knobs for the desired sound.
5. Move the expression pedal to the toe down position.
6. Adjust the knobs for the desired sound.
7. Hold the right footswitch for 3 seconds to save the configuration. The right LED will blink green to indicate that the configuration has been saved.

Knobs that are not adjusted during configuration will not be affected by the expression pedal. Expression pedal assignments are stored in presets and when the expression pedal is unplugged or power is turned off. Expression pedals with 5-25 kΩ linear potentiometers work best.

## Control Voltage

Control voltage input is configured the same way as an expression pedal.

CV Range: 0-3.3V (with over/under-voltage protection)

Tip: 0-3.3V input

Ring: 3.3V output (with current limiting)

Sleeve: ground

The expression input has current limiting in case you use a TS cable, but it is preferable to use a 1/4" TRS cable with the ring unconnected. We sell a suitable cable at our web site, and the Expert Sleepers 'floating ring' cable is another option. Instructions for building your own cable are available on our [Knowledge Base](#).

## Tap Tempo

Uses a normally open momentary switch. Configure it using the web editor.

## TRS MIDI

Select **MIDI (TRS)** in the web editor to use the control port as a MIDI input. This is a non-standard MIDI interface, because there is no optocoupler on the input to prevent current loops, but it is used by many guitar pedals. You will need a converter or a MIDI controller with 1/4" TRS outputs, which are available from Empress Effects, Disaster Area Designs, and others.

## Remote Switch

A remote switch has up to 4 modes of 4 switches that can access presets and pedal functions. It works with our remote switches, some third-party switches, and is DIY friendly for different control interfaces. See our [Knowledge Base](#) for information on building a compatible switch. Note that the switch uses parallel resistors, and switches with shorting contacts will not work without an adapter (most tap-tempo switches and the Roland FS-6, for example).

1, 2, 3, and 4-button switches are supported. The modes and functions accessible will depend on the number of buttons. A single-button switch can load or save your favorite sound.

To save a preset, hold the corresponding button for two seconds. The right LED will blink green to indicate that the preset has been stored. Presets are also accessible via the **PRESET** button and MIDI program change messages.

Configuring a Remote Switch:

1. Start with the pedal powered on and nothing plugged into the **CTRL** port.
2. Hold the right footswitch while plugging in the remote switch. The right LED will blink yellow 3 times to indicate it is in **CTRL** configuration mode. You can release the right footswitch and begin configuration immediately.
3. Press one of the buttons on the remote switch to select a mode.
4. Hold the right footswitch for 2 seconds to save the configuration. The right LED will blink green to indicate that the configuration has been saved.

# Tap Tempo

You can set independent note divisions for delay time, reverb pre-delay, and tremolo rate. The tap divisions are stored in presets, and delay note division set via the mode knob is remembered when power is removed.

The **CTRL** port supports external tap tempo switches that use a normally open contact, including multi-output tap controllers. Some remote switch modes also provide a tap tempo switch. Tap the switch at quarter note intervals to set the delay time using tap tempo. The LED will blink yellow to indicate the current tempo. To cancel tap tempo, quickly double tap the left (**TAP**) footswitch.

Adjusting a knob will disable tap tempo for that parameter. To re-enable tap tempo, set the interval again or reload the preset.

If you need to synchronize multiple tap-tempo pedals, you can use a multiple output tap controller, USB, or 1/4" TRS MIDI.

To set delay tap divisions, hold the **SHIFT** button and rotate the mode knob. More note divisions are available via MIDI or using our web editor.

By default, the delay time is set for quarter notes and tap divisions are off for other parameters.

## Delay note divisions (MODE knob)

Mode	Note Division
ROOM	Off
HALL	Half note
CATH	Dotted quarter note
GATE	Quarter note
REV	Quarter note triplet
PLATE	Dotted eighth note
SPRING	Eighth note
GRAIN	Eighth note triplet

# Using MIDI

Your pedal supports USB MIDI (in/out) and 1/4" TRS MIDI (input only).

## USB MIDI

Your pedal is a class-compliant USB device, which allows you to:

- Control all parameters
- Access additional hidden parameters

The pedal can work with any USB MIDI host, including:

- Macintosh and Windows computers. The pedal shows up as a MIDI device and is available to all programs.
- Apple iPad, iPod touch, and iPhone using the Lightning to USB 3 Camera Adapter.
- Standalone USB MIDI hosts allow you to connect the Tensor to hardware with 5-pin DIN MIDI connectors without the use of a computer. Examples include:

iConnectivity iConnectMIDI4+

iConnectivity mio4

Disaster Area Designs Gen3 MIDI controllers with their gHOST option

Kenton MIDI USB Host MkII

MidiPlus USB MIDI Host

See our [Knowledge Base](#) for up-to-date information

The pedal sends and receives on MIDI channel 1 by default. You can change the MIDI channel using MIDI System Exclusive messages or our web-based editor. The MIDI channel is remembered when power is off. See "System Exclusive (SysEx)" on page 29 for more information.

## TRS MIDI Input

See "Control Input" on page 19 for information about configuring TRS MIDI. Only MIDI input is supported, so you can use the web editor to change parameters and configuration settings, but it will not show the current state of the pedal.

## MIDI Timing Clock

MIDI timing clock messages are used to synchronize multiple MIDI devices to a single clock transmitter. The clock is typically provided by a DAW in computer-based setups and a sequencer or drum machine in hardware-only setups. Dedicated MIDI clock generators are available for more complicated setups that need tight synchronization, and some devices can convert between MIDI clock, DIN sync, and taps.

### How MIDI clock works

MIDI clocks are sent out at regular intervals by a clock *transmitter* to one or more *receivers*. The transmitter controls playback and sets the tempo.

The transmitter never tells the receivers the actual tempo. Instead it sends 24 timing clock messages

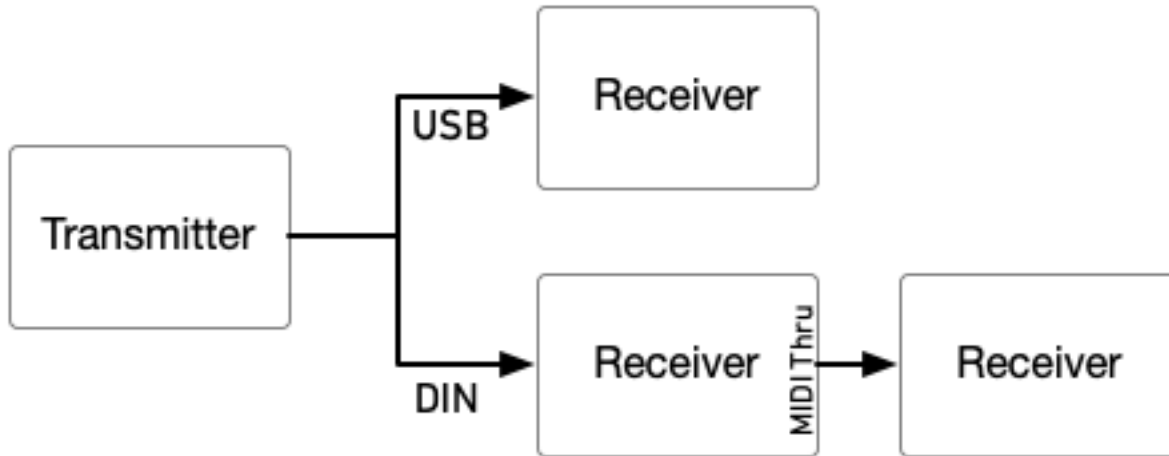

every quarter note (24 PPQ) and the receivers each calculate the tempo independently.

Start, stop, and continue messages are used to synchronize playback between devices. The transmitter

### MIDI Clock at 120 BPM

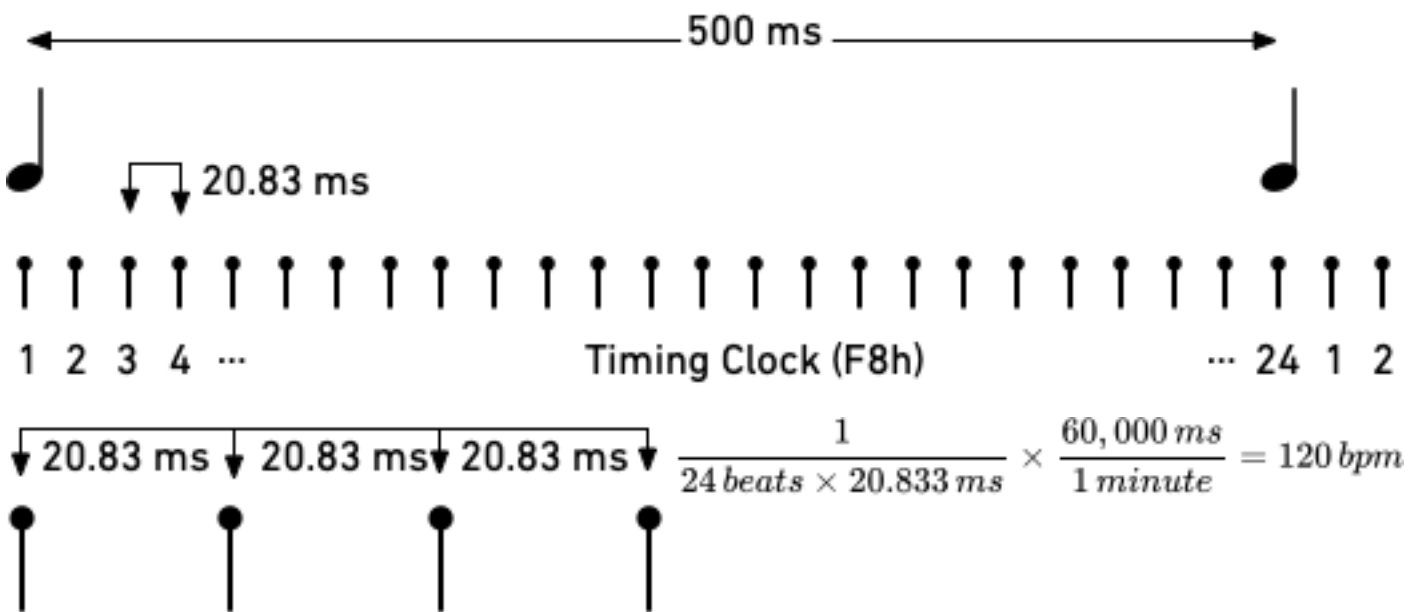

continues sending timing clocks when it is stopped so that receivers can be ready when playback starts or continues. A start message will reset playback to the first beat, and a continue message will pick up where playback left off.

MIDI real time messages are high-priority messages that can interrupt other MIDI messages to ensure the best possible synchronization timing. However, the accuracy of the clock depends on the transmitter and any devices it passes through. It is common to have +/-1 milliseconds of *jitter*, with is irregular timing due to individual clock ticks arriving too early or too late. All equipment that receives MIDI clock needs to smooth out the timing to maintain a stable tempo. The smoothing algorithm needs to handle jitter, but also track sudden or gradual tempo changes accurately and naturally. Different manufacturers use different synchronization algorithms, which can lead to sloppy timing. This was more of a problem with older MIDI equipment that had slower processors and complex setups with long MIDI chains and routers. It can also be a useful technique, synchronizing multiple hardware sequencers to give each musical part a slightly different timing and feel.

### 120 BPM with ±1 ms jitter

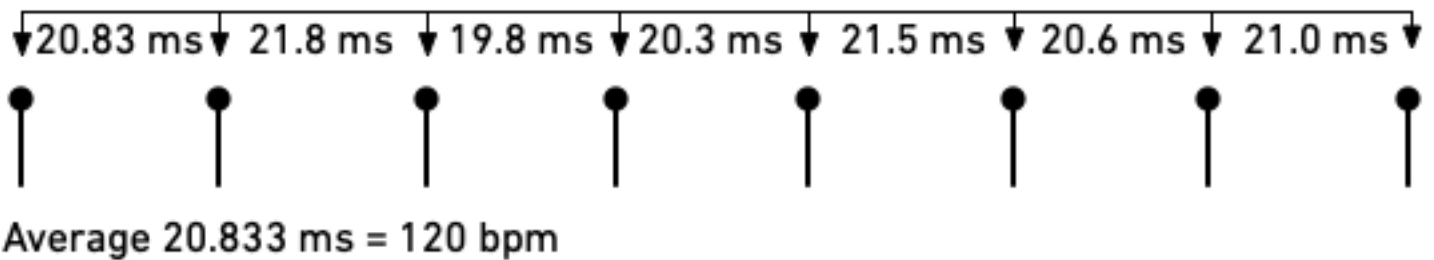

Some devices do not transmit start, stop, and continue messages, so the pedal will begin synchronizing if it receives a MIDI timing clock message without a start or stop message first.

### Comparison to tap tempo

Tap tempo is set by tapping quarter notes on a footswitch. It is simpler to set up, but is not synchronized to other equipment unless you are using a multi-pedal tap tempo controllers. Tap tempo controllers have an electronic switch on each output that simulates a footswitch press.

Neither tap tempo nor MIDI timing clock sends tempo information. The pedal calculates the tempo from the input and adjusts to tempo changes. Because MIDI timing clock sends 24 clock ticks per quarter note instead of 1 tap per quarter note, it enables tighter synchronization between equipment.

Note divisions for the pedal's parameters are configured the same way for tap tempo and MIDI clock, so you can switch between methods for recording and live use.

### Configuring your pedal for MIDI clock

In the web editor's **Config** tab, set **Receive MIDI Clock** to On. You can also send MIDI continuous controller #110 to the pedal with a value of 64-127. The MIDI clock setting is remembered when power is turned off.

### Setting note divisions

Configure note divisions using the pedal's "shift" mode, or using the web editor. See "Tap Tempo" for information about note divisions for each parameter.



## Reset to Factory Defaults

Use the following procedure to reset the Context's configuration data to factory default settings. This will erase any advanced configuration and control port settings, but presets will not be affected. Secondary parameters will be reset to their default values and expression pedal will be assigned to **DECAY**.

1. With the pedal unplugged, set the mode switch to the **ROOM** position.
2. Hold the **ON** footswitch while plugging in power. The right LED will be solid white.
3. Rotate the mode switch to the **GRAIN** position.
4. Release the **ON** footswitch.
5. When the factory reset is complete, the LEDs will cycle through different colors.
6. Power cycle the pedal to continue.

## MIDI Continuous Controller Messages

CC Num	Destination	Notes	
4	Expression pedal	CTRL input	
12	Blend		
13	Reverb predelay		
14	Reverb decay		
15	Low response		
16	High response		
17	Modulation amount		
18	Modulation rate		
20	Delay time		
21	Delay feedback		
22	Reverb / delay balance		
23	Dynamics threshold		
24	Dynamics recovery time	0-63 64 65-127	Ducking Off Expansion
80	PRESET / [ $\infty$ ]	Use gated mode to send 127 on press and 0 on release. Matches footswitch behavior.	
		0-63 64-127	Off (release) On (press)
81	ON / [ $\infty$ ]	Use gated mode to send 127 on press and 0 on release. Matches footswitch behavior.	
		0-63 64-127	Off (release) On (press)
86	Reverb Hold ( $\infty$ ) - left (Receive only)	0-63 64-127	Off On
87	Reverb Hold ( $\infty$ ) - right (Receive only)	0-63 64-127	Off On

<b>CC Num</b>	<b>Destination</b>	<b>Notes</b>	
88	Bypass (Receive only)	0-63 64-127	Bypass Effect On
89	Tap (Receive only)	64-127	Remote tap
102	Algorithm	0 1 2 3 4 5 6 7	Room Hall Cathedral Gated Reverse Plate Spring Grain
106	Delay note division	See "Note Divisions" table	
107	Predelay note division	See "Note Divisions" table	
108	Tremolo note division	See "Note Divisions" table	
110	Receive MIDI clock (global)	0-63 64-127	Off On (default)
111	Trails	0 64 127	Off On Global (default)

## Note Division Continuous Controller Values

Allowable values for each parameter are limited by the minimum and maximum parameter values. Note that values are grouped by dotted/basic/triplet notes for each division and are not in strictly decreasing order.

CC Value	Note Division
0	Off (tap tempo disabled)
1	8 measure
2	7 measures
3	6 measures
4	5 measures
5	4 measures
6	3 measures
7	2 measures
8	2 measure triplet
9	Dotted whole note
10	Whole note
11	Whole note triplet
12	Dotted half note
13	Half note
14	Half note triplet
15	Dotted quarter note
16	Quarter note
17	Quarter note triplet
18	Dotted eighth note
19	Eighth note
20	Eighth note triplet
21	Dotted 16th note
22	16th note
23	16th note triplet
24	Dotted 32nd note
25	32nd note
26	32nd note triplet
27	Dotted 64th note
28	64th note
29	64th note triplet
30	Dotted 128th note
31	128th note

## MIDI System Exclusive Messages

The Context uses MIDI System Exclusive Messages to get and set configuration properties and state. The following System Exclusive messages can be used to configure the Context, read current configuration, and access other functionality that is not available through standard MIDI messages (for example, saving presets to internal memory). You can use these messages to write a custom editor or configure a MIDI controller to control the Context.

The basic format is the same for all messages:

Byte (hex)	Description
F0	System Exclusive (SysEx)
00	Red Panda ID byte 1
02	Red Panda ID byte 2
23	Red Panda ID byte 3
01	Context family ID
02	Context product ID
00	Message version
1 byte	Message type: 0x34: get property 0x35: reply to get property 0x36: set property
2 bytes	Property ID
nn bytes	Property data (length depends on ID)
F7	End of Exclusive (EOX)

### Example: Save Preset to Internal Memory 3

Byte (hex)	Description
F0	System Exclusive (SysEx)
00	Red Panda ID byte 1
02	Red Panda ID byte 2
23	Red Panda ID byte 3
01	Context family ID
02	Context product ID
00	Message version
36	Set property
7F	Save preset to memory byte 1
13	Save preset to memory byte 2
03	Preset location (0-based program change number)
F7	End of Exclusive (EOX)

## Properties

### Firmware Version

Get	Set	ID 1	ID 2	Data Bytes	Data
X		7F	01	8	Firmware version: 0: Major 1: Minor 2: Patch 3: Release type (ascii) 4-7: Build number

Returns the firmware version.

### Input voltage

Get	Set	ID 1	ID 2	Data Bytes	Data
X		7F	0B	2	100 * PSU voltage in Volts

Returns the approximate input voltage. Can be useful for diagnosing power issues.

### Maximum input level (headroom)

Get	Set	ID 1	ID 2	Data Bytes	Data
X	X	7F	10	1	02: +5.2 dBu max (4.0 Vpp) (default) 03: +0.5 dBu max (2.3 Vpp) 04: +8 dBu max (5.7 Vpp) 05: +12 dBu with -3 dB pad

Adjusts the input/output gain to accommodate different signal levels.

### Bypass Mode

Get	Set	ID 1	ID 2	Data Bytes	Data
X	X	7F	11	1	01: analog bypass 02: DSP bypass 03: kill dry 05: analog + FX level (unity gain analog dry)

### Input / Output Configuration

Get	Set	ID 1	ID 2	Data Bytes	Data
X	X	7F	15	1	00: mono in / mono out 01: mono in / stereo out 02: stereo in / stereo out

## Remote Modes

Mode	Switch	Function	LED Indication
1	A	Preset 1 (hold to save)	Blinks green when saved
	B	Preset 2 (hold to save)	Blinks green when saved
	C	Preset 3 (hold to save)	Blinks green when saved
	D	Preset 4 (hold to save)	Blinks green when saved
2	A	Preset / live knob settings	
	B	Bypass / on	
	C	Reverb hold (latching)	
	D	Tap	Blinks yellow at tempo
3	A	Dry kill (momentary)	
	B	Delay Kill (momentary)	
	C	Reverb sustain (momentary)	
	D	Reverb damping (momentary)	

In mode 1, you can also hold the Context's **SHIFT** switch while pressing the remote switch to save a preset.





# Web Editor

The web editor can be used to configure your pedal, access hidden parameters, and fine-tune presets. It is intended for "offline" configuration and editing. For live performance editing, we recommend using dedicated MIDI hardware or software and MIDI control change messages.

Connect your pedal to a computer using a USB cable and go to the web editor URL using Chrome:

<https://www.redpandalab.com/content/apps/context-editor/index.html>

Note the **https** in the URL. **http** will not allow the browser to access your MIDI devices.

The editor uses Web MIDI, which is not supported by all browsers. We officially support Chrome.

## Pedal Status

The web editor indicates whether the pedal is connected. If the status is "not found", ensure that the pedal is turned on and connected to your computer. Click the refresh button to refresh the status.



## Edit

The Edit tab shows all of the pedal's realtime parameters. The on-screen controls are updated to match the current state of the pedal, but hidden parameters are not updated. Press the **Refresh** button to update all of the parameters. The web editor's controls allow higher resolution changes than MIDI continuous controller messages.

## Ctrl Port

The Ctrl Port tab allows you to configure the pedal's **CTRL** port for an expression pedal or remote switch. The control port mode (expression or remote) is stored globally, but expression pedal assignment and remote switch configuration are stored in each preset.

The expression pedal can be assigned to up to 6 parameters, with a minimum/maximum range for each.

## Preset

The Preset tab allows you to send MIDI program change messages and save presets to the pedal's on-board memory. Preset 1 is also available via the pedal's **PRESET** footswitch.

## Config

The Config tab allows you to configure the pedal for your setup.

If the pedal detects an error condition, a diagnostic code will be displayed on this tab.

This tab also displays the installed firmware version and the input power supply (PSU) voltage. A low PSU voltage may indicate that the power supply is not able to provide enough current to properly power the pedal.

## Help

The **Show MIDI Devices** button on the Help tab will display all of the MIDI devices accessible by your browser.

### MIDI Channel

Get	Set	ID 1	ID 2	Data Bytes	Data
X	X	7F	12	1	00: channel 1 (default) 01: channel 2 ... 0F: channel 16

Get or set MIDI channel.

### Save Preset

Get	Set	ID 1	ID 2	Data Bytes	Data
	X	7F	13	1	Preset location (MIDI program number)

Save a preset to internal memory.

### Global Trails

Get	Set	ID 1	ID 2	Data Bytes	Data
X	X	7F	16	1	00: off 01: on

May be overridden by preset trails setting.

### Receive MIDI Clock

Get	Set	ID 1	ID 2	Data Bytes	Data
X	X	7F	17	1	00: off 01: on

Global MIDI clock on/off. To disable MIDI clock sync for a preset, set all note division parameters off.

### Right Footswitch Freeze Mode

Get	Set	ID 1	ID 2	Data Bytes	Data
X	X	7F	19	1	00: freeze current reverb, live signal dry 01: freeze current reverb, play live signal through same 02: <i>not used</i> 03: infinite sustain

### Get / Set Parameter Value (high resolution)

Get	Set	ID 1	ID 2	Data Bytes	Data
X	X	yy	yy	1	U1.23 fixed point value encoded as 4 7-bit digits

Uses internal parameter IDs to get and set parameters with high resolution. The property IDs (yyyy) are not currently documented, but can be found using our web editor and a MIDI monitor. We reserve the right to change the IDs and data format, so please email us if you plan to use them (or have any questions). Values are unsigned 1.23 fixed point numbers from 0 to 1, inclusive.

# Support and Repairs

## **Technical Support**

Please register your product at [redpandalab.com/register](https://redpandalab.com/register) within 30 days of purchase.

For technical support, send your question via email to [support@redpandalab.com](mailto:support@redpandalab.com) or use the [contact form](#) on our web site. Be sure to include your serial number. We are a small company with limited resources for technical support, so it might take us a few days to reply.

Product manuals and firmware updates are available at [redpandalab.com/support](https://redpandalab.com/support)

## **Repairs**

If you think your product needs repair, first send an email with your serial number and a description of the problem to [support@redpandalab.com](mailto:support@redpandalab.com). We may be able to get you up and running again without sending in the pedal, but if it does need repair we will arrange for it to come back to us or an authorized service center close to you. Warranty repairs are done for free, and non-warranty repairs will be done at the lowest possible cost to you.

# Warranty

## ONE YEAR LIMITED MANUFACTURER'S WARRANTY

- 1. Limited Warranty.** For one (1) year following the date of purchase, Red Panda, LLC will repair or replace, in its sole discretion, the Product, in order to correct defects in material or workmanship that existed when the Product was purchased (collectively, "Manufacturing Defects". For purposes of this Limited Warranty, "Manufacturing Defects" includes only defects in the Product at the time of purchase and does not include normal wear and tear, modification post-sale, misuse, accidental damage or destruction, or other abuse occurring after purchase.
- 2. SOLE AND EXCLUSIVE REMEDY.** THE REPAIR AND/OR REPLACEMENT OF THE PRODUCT SHALL BE THE SOLE AND EXCLUSIVE REMEDY FOR MANUFACTURING DEFECTS. PROOF OF ORIGINAL PURCHASE DATE IS REQUIRED TO RECEIVE REPAIR OR REPLACEMENT OF THE PRODUCT.
- 3. DISCLAIMER OF IMPLIED WARRANTIES.** IMPLIED WARRANTIES, INCLUDING ANY IMPLIED WARRANTY OF MERCHANTABILITY OR IMPLIED WARRANTY OF FITNESS FOR A PARTICULAR PURPOSE, ARE LIMITED TO ONE YEAR OR THE SHORTEST PERIOD ALLOWED BY LAW. RED PANDA MAKES NO REPRESENTATIONS REGARDING THE PERFORMANCE OF, THE QUALITY OR THE DURABILITY OF THE PRODUCT OTHER THAN THOSE EXPRESSLY SET FORTH HEREIN.
- 4. LIMITATION OF REMEDIES, EXCLUSION OF INCIDENTAL AND CONSEQUENTIAL DAMAGES.** THE SOLE AND EXCLUSIVE REMEDY UNDER THIS LIMITED WARRANTY SHALL BE PRODUCT REPAIR OR REPLACEMENT AS PROVIDED HEREIN. RED PANDA SHALL NOT BE LIABLE FOR ANY INCIDENTAL OR CONSEQUENTIAL DAMAGES. Some states and countries do not allow this exclusion or limitation, so these limitations and exclusions may not apply to you.
- 5. Return and/or Replacement of Product due to a Manufacturing Defect.** In the event of believed manufacturing defect, you should contact Red Panda at support@redpandalab.com, with the date of original purchase, a copy of the receipt and a description of the asserted Manufacturing Defect. Red Panda will, at its sole discretion, notify you to return the Product at the specified location or, alternatively ship a replacement Product within thirty (30) days of receipt. You are solely responsible for the payment of shipping costs and expenses to ship the Product to Red Panda. Red Panda will pay the cost of shipping the repaired or replacement Product to you. If the Product is returned for service and/or repairs, Red Panda will complete the repairs within sixty (60) days of receipt and ship the Product back to you. The Product will be warranted for the remaining term of the original Product's warranty period.

# Firmware Updates

The Context's firmware can be updated via drag and drop using any Mac or PC. No driver or special software is required.

## **To tell which version of firmware your pedal is running:**

1. Hold down the PRESET (left) footswitch and connect power.
2. The right LED will blink blue.
3. Continue holding the PRESET footswitch for 2 seconds.
4. The LED will turn solid blue. The pedal is now in USB Mass Storage mode.
5. Connect the pedal to the computer using a mini USB cable.
6. Open the CONTEXT drive on your computer.
7. Open the VERSION.TXT file in a text editor.

## **Downloading the new firmware**

1. Go to <http://www.redpandalab.com/downloads/#context>
2. Download the firmware (.zip) file to your computer.
3. Unzip the downloaded file to extract the binary firmware file (.bin).

## **Caution**

- Do not rename the extracted file.
- Never turn off the pedal's power while an update is in progress. Otherwise the system software or the pedal itself may be destroyed.

## **Update procedure:**

1. Hold down PRESET (left) footswitch and connect power.
2. The right LED will blink blue.
3. Continue holding the PRESET footswitch for 2 seconds.
4. The LED will turn solid blue. The pedal is now in USB Mass Storage mode.
5. Connect the pedal to the computer using a mini USB cable.
6. Open the CONTEXT drive on your computer.
7. Drag and drop the firmware binary (.bin) file to the CONTEXT drive.
8. The left LED will blink to show progress.
9. After the firmware update is complete, the LED will turn solid green.  
If the firmware update seems to stall, eject the CONTEXT drive from your computer and it should resume. If not, retry the procedure.
10. If an error occurred, the red LED will blink instead.
11. Eject the CONTEXT drive from your computer:  
Mac: click the eject button or drag the CONTEXT icon to the trash  
Windows: right-click on the USB DRIVE icon in My Computer and select "Eject"
12. Disconnect the USB cable.
13. Turn the pedal's power off.

## **Troubleshooting**

If the left LED blinks red or the process stalls, turn the Context off, then on, and try again.

If you continue to have problems, please email [support@redpandalab.com](mailto:support@redpandalab.com). Please tell us what type of computer and which operating system version you are using.

## Specifications

Maximum input level:	+0.5 dBu (high gain) +5.2 dBu (default) +8 dBu (max with unity gain) +12 dBu (max with -3 dB pad)
Frequency response:	20-20 kHz, +0/-0.5 dB
Input impedance:	1 M $\Omega$
Output impedance:	< 1 k $\Omega$
Bypass:	analog buffered
Power supply:	9V DC, center negative
Power connector:	2.1mm I.D. x 5.5mm O.D. barrel connector
Power consumption:	250 mA
Dimensions:	78 (W) x 124 (D) x 59 (H) mm 3.1 (W) x 4.9 x 2.3 (H) inches
Weight:	0.4 kg / 14 oz

## Credits

Design and engineering	Curt Malouin
Documentation	Curt Malouin
Graphics	Sylvie Demers Eric Iverson
Sound consulting	Eric Iverson