

SHARP®

AQUOS

LC-60LE450U LC-60LE452U

LIQUID CRYSTAL TELEVISION
TÉLÉVISEUR ACL
TELEVISOR CON PANTALLA
DE CRISTAL LÍQUIDO

OPERATION MANUAL
MODE D'EMPLOI
MANUAL DE OPERACIÓN



ENGLISH

FRANÇAIS

ESPAÑOL



IMPORTANT : Please read this operation manual before starting operating the equipment.
IMPORTANT : Veuillez lire ce mode d'emploi avant de commencer utiliser l'appareil.
IMPORTANTE: Lea este manual de operación antes de comenzar a operar el equipo.

LC-60LE450U LC-60LE452U

LIQUID CRYSTAL TELEVISION ENGLISH

OPERATION MANUAL





IMPORTANT:

To aid reporting in case of loss or theft, please record the TV's model and serial numbers in the space provided. The numbers are located at the rear of the TV.

Model No.:
Serial No.:

IMPORTANT INFORMATION

WARNING: TO REDUCE THE RISK OF FIRE OR ELECTRIC SHOCK, DO NOT EXPOSE THIS PRODUCT TO RAIN OR MOISTURE.

 <div style="text-align: center;"> <p>CAUTION</p> <p>RISK OF ELECTRIC SHOCK. DO NOT OPEN</p>  </div>	 <p>The lightning flash with arrow-head symbol, within an equilateral triangle, is intended to alert the user to the presence of uninsulated "dangerous voltage" within the product's enclosure that may be of sufficient magnitude to constitute a risk of electric shock to persons.</p>
<p>CAUTION: TO REDUCE THE RISK OF ELECTRIC SHOCK, DO NOT REMOVE COVER (OR BACK). NO USER SERVICEABLE PARTS INSIDE. REFER SERVICING TO QUALIFIED SERVICE PERSONNEL</p>	 <p>The exclamation point within a triangle presence of important operating and maintenance (servicing) instruction in the literature accompanying the product.</p>  <p>This equipment is a Class II or double insulated electrical appliance. It has been designed in such a way that it does not require a safety connection to electrical earth.</p>

IMPORTANT INFORMATION

CAUTION: TO PREVENT ELECTRIC SHOCK, MATCH WIDE BLADE OF PLUG TO WIDE SLOT, FULLY INSERT.

WARNING: FCC Regulations state that any unauthorized changes or modifications to this equipment not expressly approved by the manufacturer could void the users authority to operate this equipment.

CAUTION:

This product satisfies FCC regulations when shielded cables and connectors are used to connect the unit to other equipment. To prevent electromagnetic interference with electric appliances such as radios and televisions, use shielded cables and connectors for connections.

DECLARATION OF CONFORMITY:

SHARP LIQUID CRYSTAL TELEVISION, MODEL LC-60LE450U/LC-60LE452U This device complies with Part 15 of the FCC Rules. Operation is subject to the following two conditions: (1) This device may not cause harmful interference, and (2) this device must accept any interference received, including interference that may cause undesired operation. RESPONSIBLE PARTY:

SHARP ELECTRONICS CORPORATION
Sharp Plaza, Mahwah, New Jersey 07495-1163
TEL: 1-800-BE-SHARP

For Business Customers: URL <http://www.sharppusa.com>

INFORMATION:

This equipment has been tested and found to comply with the limits for a Class B digital device, pursuant to Part 15 of the FCC Rules. These limits are designed to provide reasonable protection against harmful interference in a residential installation. This equipment generates, uses and can radiate radio frequency energy and, if not installed and used in accordance with the instructions, may cause harmful interference to radio communications. However, there is no guarantee that interference will not occur in a particular installation. If this equipment does cause harmful interference to radio or television reception, which can be determined by turning the equipment off and on, the user is encouraged to try to correct the interference by one or more of the following measures:

- Reorient or relocate the receiving antenna.
- Increase the separation between the equipment and receiver.
- Connect the equipment into an outlet on a circuit different from that to which the receiver is connected.
- Consult the dealer or an experienced radio/TV technician for help.

Note to CATV system installer: This reminder is provided to call the CATV system installer's attention to Article 820 of the National Electrical Code that provides guidelines for proper grounding and, in particular, specifies that the cable ground shall be connected to the grounding system of the building, as close to the point of cable entry as practical.

TRADEMARKS

- The terms HDMI and HDMI High-Definition Multimedia Interface, and the HDMI Logo are trademarks or registered trademarks of HDMI Licensing LLC in the United States and other countries.
- Manufactured under license from Dolby Laboratories. Dolby and the double-D symbol are trademarks of Dolby Laboratories.

DEAR SHARP CUSTOMER

Thank you for your purchase of the Sharp Liquid Crystal Television. To ensure safety and many years of trouble-free operation of your product, please read the Important Safety Instructions carefully before using this product.

IMPORTANT SAFETY INSTRUCTIONS

Electricity is used to perform many useful functions, but it can also cause personal injuries and property damage if improperly handled. This product has been engineered and manufactured with the highest priority on safety. However, improper use can result in electric shock and/or fire. In order to prevent potential danger, please observe the following instructions when installing, operating and cleaning the product. To ensure your safety and prolong the service life of your Liquid Crystal Television, please read the following precautions carefully before using the product.

- 1) Read these instructions.
- 2) Keep these instructions.
- 3) Heed all warnings.
- 4) Follow all instructions.
- 5) Do not use this apparatus near water.
- 6) Clean only with dry cloth.
- 7) Do not block any ventilation openings. Install in accordance with the manufacturer's instructions.
- 8) Do not install near any heat sources such as radiators, heat registers, stoves, or other apparatus (including amplifiers) that produce heat.
- 9) Do not defeat the safety purpose of the polarized or grounding-type plug. A polarized plug has two blades with one wider than the other. A grounding type plug has two blades and a third grounding prong. The wide blade or the third prong are provided for your safety. If the provided plug does not fit into your outlet, consult an electrician for replacement of the obsolete outlet.
- 10) Protect the power cord from being walked on or pinched particularly at plugs, convenience receptacles, and the point where they exit from the apparatus.
- 11) Only use attachments/accessories specified by the manufacturer.
- 12) Use only with the cart, stand, tripod, bracket, or table specified by the manufacturer, or sold with the apparatus. When a cart is used, use caution when moving the cart/apparatus combination to avoid injury from tip-over.
- 13) Unplug this apparatus during lightning storms or when unused for long periods of time.
- 14) Refer all servicing to qualified service personnel. Servicing is required when the apparatus has been damaged in any way, such as power-supply cord or plug is damaged, liquid has been spilled or objects have fallen into the apparatus, the apparatus has been exposed to rain or moisture, does not operate normally, or has been dropped.



Additional Safety Information

- 15) Power Sources—This product should be operated only from the type of power source indicated on the marking label. If you are not sure of the type of power supply to your home, consult your product dealer or local power company. For products intended to operate from battery power, or other sources, refer to the operating instructions.
- 16) Overloading—Do not overload wall outlets, extension cords, or integral convenience receptacles as this can result in a risk of fire or electric shock.
- 17) Object and Liquid Entry—Never push objects of any kind into this product through openings as they may touch dangerous voltage points or short-out parts that could result in a fire or electric shock. Never spill liquid of any kind on the product.
- 18) Damage Requiring Service—Unplug this product from the wall outlet and refer servicing to qualified service personnel under the following conditions:
 - a) When the AC cord or plug is damaged,
 - b) If liquid has been spilled, or objects have fallen into the product,
 - c) If the product has been exposed to rain or water,
 - d) If the product does not operate normally by following the operating instructions.
Adjust only those controls that are covered by the operating instructions as an improper adjustment of other controls may result in damage and will often require extensive work by a qualified technician to restore the product to its normal operation,
 - e) If the product has been dropped or damaged in any way, and
 - f) When the product exhibits a distinct change in performance - this indicates a need for service.
- 19) Replacement Parts—When replacement parts are required, be sure the service technician has used replacement parts specified by the manufacturer or have the same characteristics as the original part. Unauthorized substitutions may result in fire, electric shock, or other hazards.
- 20) Safety Check—Upon completion of any service or repairs to this product, ask the service technician to perform safety checks to determine that the product is in proper operating condition.
- 21) Wall or ceiling mounting—When mounting the product on a wall or ceiling, be sure to install the product according to the method recommended by the manufacturer.

IMPORTANT SAFETY INSTRUCTIONS

CAUTION

- These servicing instructions are for use by qualified service personnel only. To reduce the risk of electric shock do not perform any servicing other than that contained in the operating instructions unless you are qualified to do so.

- **Outdoor Antenna Grounding** — If an outside antenna is connected to the television equipment, be sure the antenna system is grounded so as to provide some protection against voltage surges and built-up static charges.

Article 810 of the National Electrical Code, ANSI/NFPA 70, provides information with regard to proper grounding of the mast and supporting structure, grounding of the lead-in wire to an antenna discharge unit, size of grounding conductors, location of antenna-discharge unit, connection to grounding electrodes, and requirements for the grounding electrode.

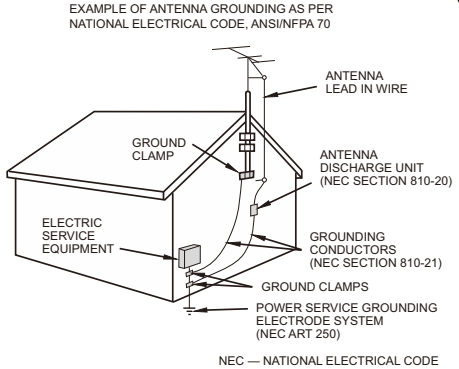

- Warning statement indicating that Class II apparatus shall be connected to a mains socket outlet with a protective earthing connection.
- Statement indicating that when the mains plug or appliance coupler shall remain readily operable.
- Where the MAINS plug or an appliance coupler is used as the disconnect device, the disconnect device shall remain readily operable.
- **Water and Moisture** — Do not use this product near water - for example, near a bath tub, wash bowl, kitchen sink, or laundry tub; in a wet basement; or near a swimming pool; and the like.
- **Stand** — Do not place the product on an unstable cart, stand, tripod or table. Placing the product on an unstable base can cause the product to fall, resulting in serious personal injuries as well as damage to the product. Use only a cart, stand, tripod, bracket or table recommended by the manufacturer or sold with the product. When mounting the product on a wall, be sure to follow the manufacturer's instructions. Use only the mounting hardware recommended by the manufacturer.
- **Selecting the location** — Select a place with no direct sunlight and good ventilation.
- **Ventilation** — The vents and other openings in the cabinet are designed for ventilation. Do not cover or block these vents and openings since insufficient ventilation can cause overheating and/or shorten the life of the product. Do not place the product on a bed, sofa, rug or other similar surface, since they can block ventilation openings. This product is not designed for built-in installation; do not place the product in an enclosed place such as a bookcase or rack, unless proper ventilation is provided or the manufacturer's instructions are followed.
- The Liquid Crystal panel used in this product is made of glass. Therefore, it can break when the product is dropped or applied with impact. Be careful not to be injured by broken glass pieces in case the panel breaks.

IMPORTANT SAFETY INSTRUCTIONS

- Heat — The product should be situated away from heat sources such as radiators, heat registers, stoves, or other products (including amplifiers) that produce heat.
- The Liquid Crystal panel is a very high technology product with 2,073,600 pixels (LC-60LE450U, LC-60LE452U). Giving you fine picture details. Occasionally, a few non-active pixels may appear on the screen as a fixed point of blue, green or red. Please note that this does not affect the performance of your product.
- Lightning — For added protection for this television equipment during a lightning storm, or when it is left unattended and unused for long periods of time, unplug it from the wall outlet and disconnect the antenna. This will prevent damage to the equipment due to lightning and power-line surges.
- Power Lines — An outside antenna system should not be located in the vicinity of overhead power lines or other electric light or power circuits, or where it can fall into such power lines or circuits. When installing an outside antenna system, extreme care should be taken to keep from touching such power lines or circuits as contact with them might be fatal.
- To prevent fire, never place any type of candle or flames on the top or near the TV set.
- To prevent fire or shock hazard, do not place the AC cord under the TV set or other heavy items.
- Do not display a still picture for a long time, as this could cause an afterimage to remain.
- To prevent fire or shock hazard, do not expose this product to dripping or splashing.
No objects filled with liquids, such as vases, should be placed on the product.
- Do not insert foreign objects into the product. Inserting objects in the air vents or other openings may result in fire or electric shock. Exercise special caution when using the product around children.

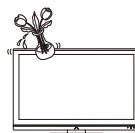

Precautions when transporting the TV

- When transporting the TV, never carry it by holding or otherwise putting pressure onto the display. Be sure to always carry the TV by two people holding it with two hands — one hand on each side of the TV.

Caring for the Cabinet

- Use a soft cloth (cotton, flannel, etc.) and gently wipe the surface of the cabinet.
- Using a chemical cloth (wet/dry sheet type cloth, etc.) may deform the components of the main unit cabinet or cause cracking.
- Wiping with a hard cloth or using strong force may scratch the surface of the cabinet.
- If the cabinet is very dirty, wipe with a soft cloth (cotton, flannel, etc.) soaked in neutral detergent diluted with water and thoroughly wrung out, and then wipe with a soft dry cloth.
- The cabinet is primarily made of plastic. Avoid using benzene, thinner, and other solvents, as these may deform the cabinet and cause the paint to peel off.
- Do not apply insecticides or other volatile liquids.
Also, do not allow the cabinet to remain in contact with rubber or vinyl products for a long period of time. Plasticizers inside the plastic may cause the cabinet to deform and cause the paint to peel off.

Caring for the Liquid Crystal panel

- Turn off the main power and unplug the AC cord from the wall outlet before handling.
- Gently wipe the surface of the display panel with a soft cloth (cotton, flannel, etc.).
To protect the display panel, do not use a dirty cloth, liquid cleaners, or a chemical cloth (wet/ dry sheet type cloth, etc.). This may damage the surface of the display panel.
- Wiping with a hard cloth or using strong force may scratch the surface of the display panel.
- Use a soft damp cloth to gently wipe the display panel when it is really dirty. (It may scratch the surface of the display panel when wiped strongly.)
- If the display panel is dusty, use an anti-static brush, which is commercially available, to clean it.
- To avoid scratching the frame or screen, please use a soft, lint free cloth for cleaning. Approved cleaning cloths are available directly from Sharp in single (00Z-LCD-CLOTH) or triple (00Z-LCD-CLOTH-3) packs.



Call 1-800-BE-SHARP for ordering, or VISIT <http://www.sharpusa.com/SharpDirect>.

IMPORTANT SAFETY INSTRUCTIONS

CHILD SAFETY

It Makes A Difference How and Where You Use Your Flat Panel Display

Congratulations on your purchase! As you enjoy your new product, please keep these safety tips in mind:

THE ISSUE



The home theater entertainment experience is a growing trend and larger flat panel displays are popular purchases. However, flat panel displays are not always supported on the proper stands or installed according to the manufacturer's recommendations.

Flat panel displays that are inappropriately situated on dressers, bookcases, shelves, desks, speakers, chests or carts may fall over and cause injury.

THIS MANUFACTURER CARES!

The consumer electronics industry is committed to making home entertainment enjoyable and safe.

TUNE INTO SAFETY

One size does NOT fit all. Follow the manufacturer's recommendations for the safe installation and use of your flat panel display.

Carefully read and understand all enclosed instructions for proper use of this product.

Don't allow children to climb on or play with furniture and television sets.

Don't place flat panel displays on furniture that can easily be used as steps, such as a chest of drawers.

Remember that children can become excited while watching a program, especially on a "larger than life" flat panel display. Care should be taken to place or install the display where it cannot be pushed, pulled over, or knocked down.

Care should be taken to route all cords and cables connected to the flat panel display so that they cannot be pulled or grabbed by curious children.



WALL MOUNTING: IF YOU DECIDE TO WALL MOUNT YOUR FLAT PANEL DISPLAY, ALWAYS:

Follow all instructions supplied by the display and wall mount manufacturers.

If you have any doubts about your ability to safely install your flat panel display contact your retailer about professional installation.

Make sure that the wall where you are mounting the display is appropriate. Some wall mounts are not designed to be mounted to walls with steel studs or old cinder block construction. If you are unsure, contact a professional installer.

A minimum of two people are required for installation. Flat panel displays can be heavy.



Note: CEA is the preeminent trade association promoting growth in the \$161 billion U.S. consumer electronics industry. More than 2,200 companies enjoy the benefits of CEA membership, including legislative advocacy, market research, technical training and education, industry promotion and the fostering of business and strategic relationships.

QUICK REFERENCE

Supplied Accessories

Make sure the following accessories are provided with the product.

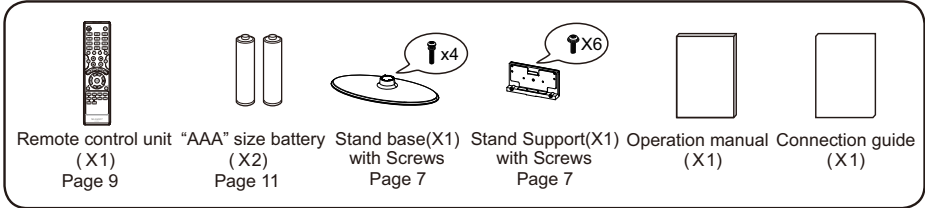

NOTE

- Always use the AC cord supplied with the TV.
- The illustrations above are for explanation purposes and may vary slightly from the actual accessories.

Attaching/Detaching the Stand

- Before attaching (or detaching) the stand, unplug the AC cord.
- Before performing work spread cushioning over the base area to lay the TV on. This will prevent it from being damaged.

CAUTION

Attach the stand in the correct direction.

Be sure to follow the instructions. Incorrect installation of the stand may result in the TV falling over.

1. Put the TV face down on a safe surface that is covered by a soft and smooth cloth. (Show in diagram 1)
2. Fix the TV stand support to the stand base, fasten the screws by using a cross-head screwdriver (Not supplied).(Show in diagram 2)
3. Fix the TV stand base to the TV, fasten the screws by using a cross-head screwdriver (Not supplied). (Show in diagram 3)

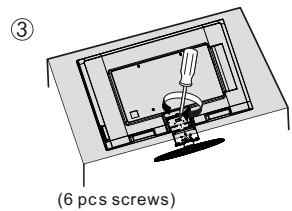
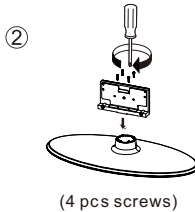
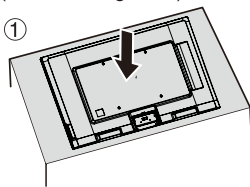

CAUTION

Do not push too hard or put excessive pressure to the stand neck to avoid the damages when you turn the TV for the most comfortable viewing angle.

NOTE

To detach the stand, perform the steps in reverse order.

Wall Mount

Use the four screws provided to fix the TV onto a wall mounting bracket (not included) via the four VESA standard holes on the back of the television.

- | | |
|---|---|
| • VESA screw hole specs(A-B) in millimeters | 15 ³ / ₄ - 15 ³ / ₄ (400-400) |
| • Standard screw | M6 (1.0 pitch screw) |
| • Quantity | 4 |

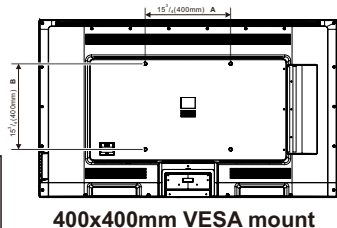

QUICK REFERENCE

Quick Installation Tips

1. Attach your antenna to the back of the television. (See page 10.)
2. Connect the AC plug for the television into the AC outlet.

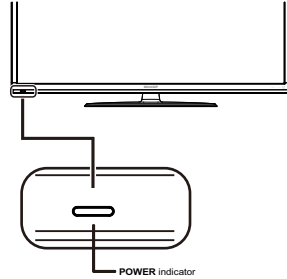
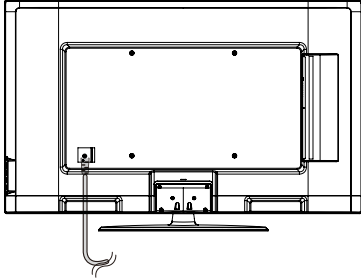

4. Insert the batteries into the remote control unit. (See page 11.)

NOTE

- Speakers cannot be detached from the TV.
- The TV angle cannot be adjusted.

Place the TV close to the AC outlet, and keep the power plug within reach.

NOTE

TO PREVENT RISK OF ELECTRIC SHOCK, DO NOT TOUCH UN-INSULATED PARTS OF ANY CABLES WITH THE AC CORD CONNECTED.

3. When turning on the TV for the first time, press **PÓWER** on the television.

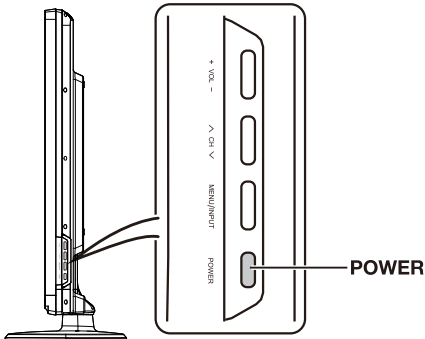

QUICK REFERENCE

Using the Remote Control Unit

Use the remote control unit by pointing it towards the remote control sensor on the TV. Objects between the remote control unit and the remote control sensor may prevent proper operation.

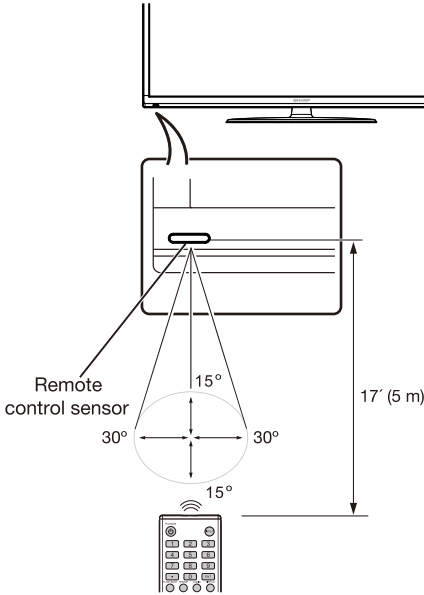

i Cautions regarding the remote control unit

- Do not expose the remote control unit to shock. In addition, do not expose the remote control unit to liquids, and do not place in an area with high humidity.
- Do not install or place the remote control unit under direct sunlight. The heat may cause deformation of the remote control unit.
- The remote control unit may not work properly if the remote control sensor on the TV is under direct sunlight or strong lighting. In such cases, change the angle of the lighting or the TV, or operate the remote control unit closer to the remote control sensor.

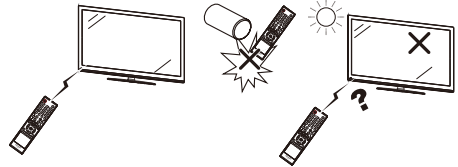

IMPORTANT:

If the POWER indicator light on the television still does not turn off, press **POWER** on the remote control to turn the power on.

IMPORTANT:

IF THE UNIT DOES NOT POWER ON - UNPLUG THE TELEVISION FROM THE OUTLET AND REPEAT THE INSTALLATION STEPS.

IF YOU STILL ENCOUNTER NO POWER, PLEASE CONTACT US AT 1-800-BE-SHARP.

Preparation

Antennas

To enjoy a clearer picture, use an outdoor antenna. The following is a brief explanation of the types of connections that are used for a coaxial cable. If your outdoor antenna uses a 75-ohm coaxial cable with an F-type connector, plug it into the antenna terminal at the rear of the TV set.

1. A 75-ohm system is generally a round cable with F-type connector that can easily be attached to a terminal without tools (Commercially available).
2. A 300-ohm system is a flat "twin-lead" cable that can be attached to a 75-ohm terminal through a 300/75-ohm adapter (Commercially available).

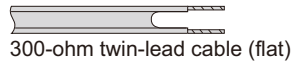
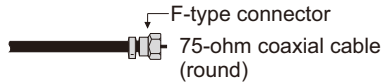

NOTE

When connecting the RF cable to the TV set, do not tighten F-type connector with tools. If tools are used, it may cause damage to your TV set. (The breaking of internal circuit, etc.)

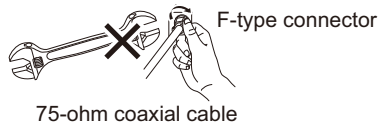

Connecting Antenna

Connect the antenna cable to the TV using one of the methods in the illustration as shown (①, ②, ③ or ④).

- ① Cable without a CATV converter



- ② VHF/UHF antenna



- ③ Combination VHF/UHF antenna

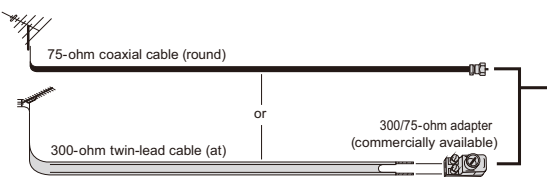

- ④ Separate VHF/UHF antenna

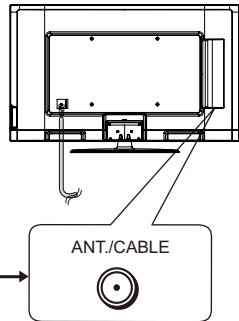
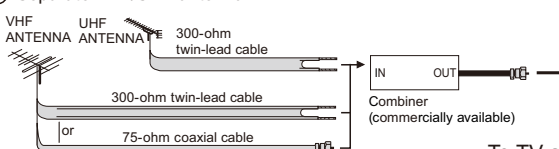

To TV antenna terminal

Preparation

Installing Batteries in the Remote Control Unit

If the remote control fails to operate TV functions, replace the batteries in the remote control unit.

1 Open the battery cover.

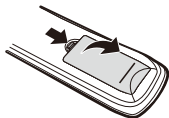

3 Close the battery cover.



2 Insert two “AAA” size batteries (supplied with the product).

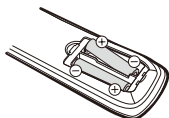

Place the batteries with their terminals corresponding to the (+) and (-) indications in the battery compartment.

CAUTION

Improper use of batteries can result in chemical leakage or explosion. Be sure to follow the instructions below.

- Do not mix batteries of different types. Different types of batteries have different characteristics.
- Do not mix old and new batteries. Mixing old and new batteries can shorten the life of new batteries or cause chemical leakage in old batteries.
- Remove batteries as soon as they are worn out. Chemicals that leak from batteries come in contact with skin can cause a rash. If you find any chemical leakage, wipe thoroughly with a cloth.
- The batteries supplied with this product may have a shorter life expectancy due to storage conditions.
- If you will not be using the remote control unit for an extended period of time, remove batteries from it.
- The batteries (batteries installed) shall not be exposed to excessive heat such as sunshine, fire or the like.

Contents

IMPORTANT INFORMATION	1
TRADEMARKS	2
IMPORTANT SAFETY INSTRUCTIONS	3
QUICK REFERENCE	7
Supplied Accessories	7
Attaching/Detaching the Stand	7
Quick Installation Tips	8
Using the Remote Control Unit	9
Antennas	10
Connecting Antenna Cable	10
Installing Batteries in the Remote Control Unit	11
Contents	12
Part Names	13
TV (Front)	13
TV (Side/Rear)	13
Introduction to Connections	14
Experiencing HD Images	14
Types of Connection	14
Displaying an External Equipment Image Display	14
Connecting to External Equipment	15
Connecting a Blu-ray Disc/DVD Player or HD Cable/Satellite Set-top Box	15
Connecting a Game Console, VCR, Camcorder or Cable/Satellite Set-top Box	16
Connecting an Audio Amplifier	17
Connecting an AV Amplifier	17
Connecting a PC	18
Watching TV	19
Turning On/Off the Power	19
Setup Wizard	19
Direct Button Operation	21
On-Screen Display Menu	25
On-Screen Display Menu Operation	25
Menu Operation Button	26
Picture Setting	26
Audio Setting	27
Time Setting	27
Option Setting	28
Lock Setting	29
Channel Setting	31
Enjoying Photo/Music/Movie Playback	33
Connecting a USB Memory Device/USB Hard Drive	33
Listening to Music	33
Viewing Pictures	33
Watching Movie	33
Appendix	34
Troubleshooting	34
Specifications	35
PC Compatibility Chart	36
Wall Mount Kit Specifications	37
Legal notices	38
Calling for Service	39
Dimensional Drawings	
The dimensional drawings for the LCD TV set are shown on the inside back cover.	

Part Names

TV (Front)

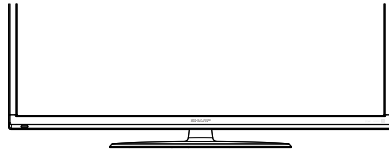

TV (Side/Rear)

*1

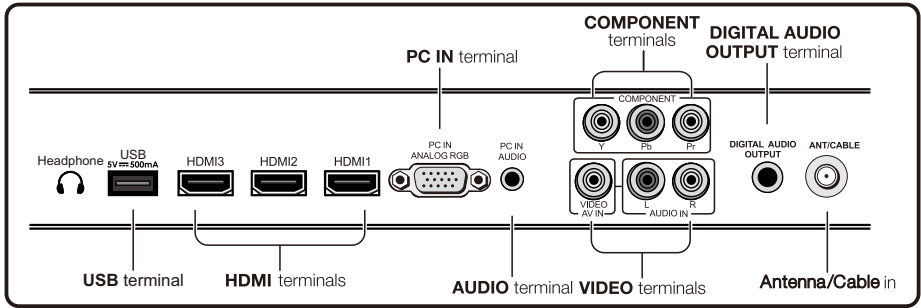

*2

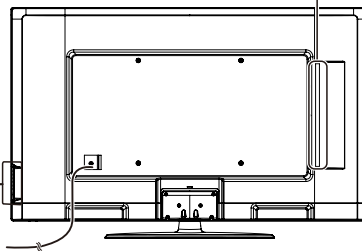
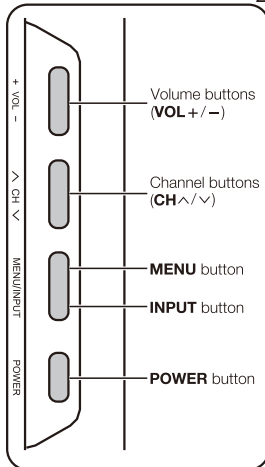

*1: See pages 15, 16, 17 and 18 for external equipment connection.

*2: See pages 14, 19, 21 and 27 for button operations.

NOTE

- The illustrations in this operation manual are for explanation purposes and may vary slightly from the actual operations.

Connecting to External Equipment

You can connect many types of external equipment to your TV. To view external source images, select the input source from INPUT on the remote control unit or on the TV. (See pages 14 and 21.) For connecting the TV to external equipment, use commercially available cables.

CAUTION

- To protect equipment, always turn off the TV before connecting any external equipment.
- Please read the relevant operation manual (Blu-ray disc player, etc.) carefully before making connections.

Connecting a Blu-ray Disc/DVD Player or HD Cable/Satellite Set-top Box

■ When using HDMI cable (HDMI 1, 2, or 3):

The HDMI (High Denition Multimedia Interface) terminal is an audio-video interface that enables a connection for audio and video signals using a single cable. The HDMI terminal supports high-resolution video input.

- Blu-ray disc player
- DVD player
- HD cable/satellite set-top box

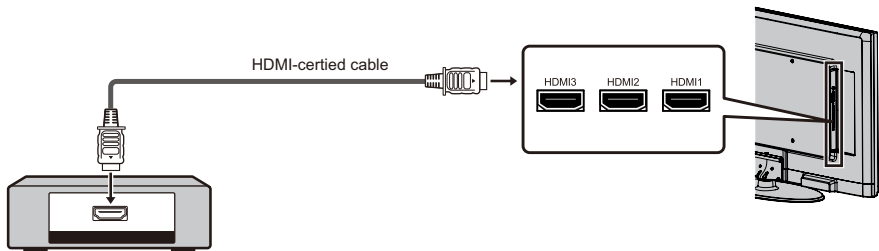

NOTE

- To enjoy 1080p display capability, connect your external equipment using an HDMI-certified cable or a component cable and set the equipment to 1080p output.
- Supported Audio format: Linear PCM, sampling rate 32/44.1/48kHz.

■ When using DVI-HDMI conversion cable (HDMI 1, 2, 3 or PC):

- Blu-ray disc player
- DVD player
- HD cable/satellite set-top box

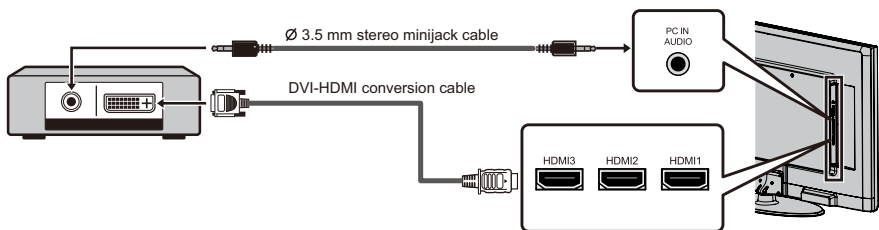

NOTE

- When using a DVI-HDMI conversion cable, you should make an analog audio connection. In this case, in addition to connecting a DVI-HDMI conversion cable to the HDMI 1,2,3 terminal, connect a \varnothing 3.5 mm stereo minijack cable to the AUDIO PC/HDMI terminal.

Connecting to External Equipment

■ When using Component cable (Y PB PR):

- Blu-ray disc player
- DVD player
- HD cable/satellite set-top box

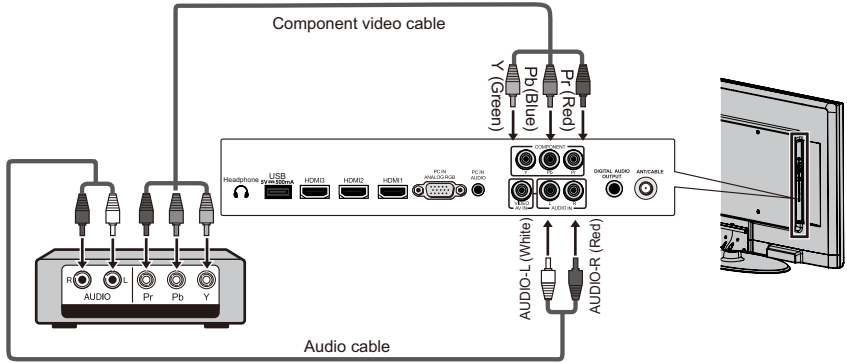

NOTE

- To enjoy 1080p display capability, connect your external equipment using an HDMI-certied cable or a component cable and set the equipment to 1080p output.
- See page 15 for connecting a Blu-ray disc player, DVD player or an HD cable/satellite set-top box to the HDMI terminal.

Connecting a Game Console, VCR, Camcorder or Cable/Satellite Set-top Box

■ When using Composite cable (AV):

- Game console
- VCR
- Camcorder
- Cable/Satellite set-top box

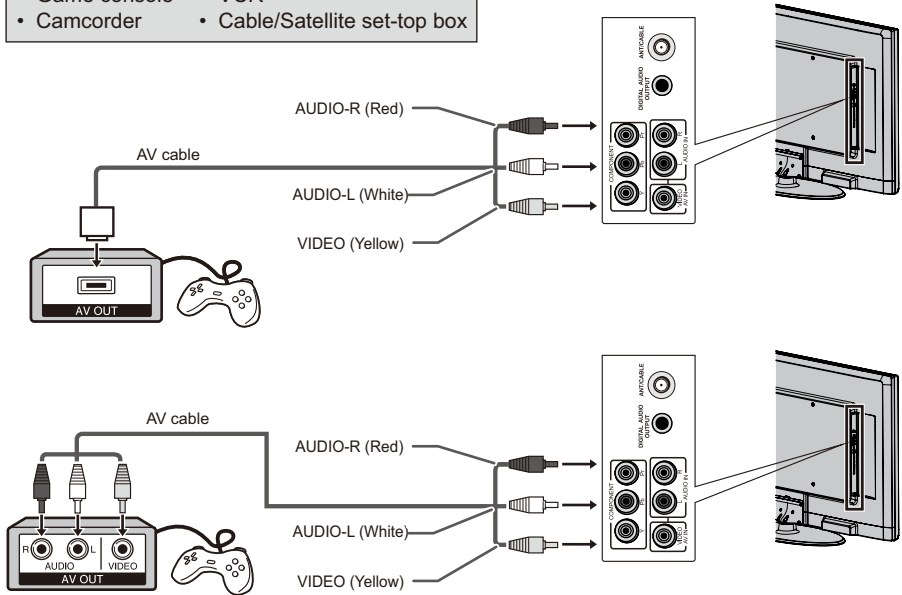

Connecting to External Equipment

Connecting an Audio Amplifier

■ When using coaxial cable:

It is possible to output audio through the DIGITAL AUDIO terminal. PCM audio outputs from the terminal.

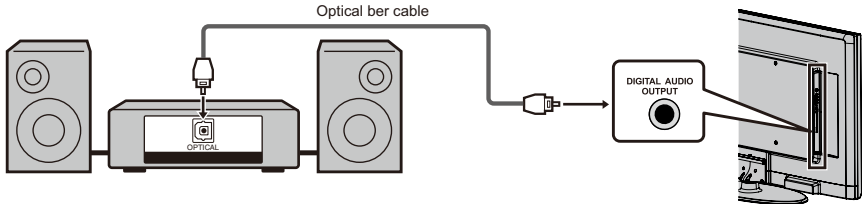

NOTE

- Digital Audio output is not available when using an HDMI input.

Connecting an AV Amplifier

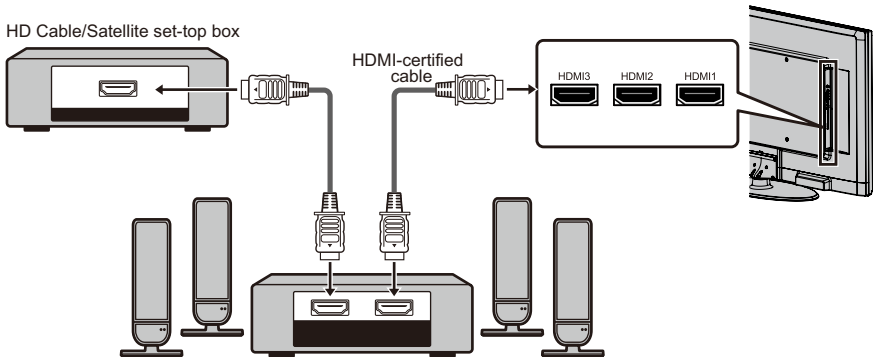

NOTE

- If the image is not in sync with the audio, check the settings of the connected surround system.
- Letting the TV output the audio to an AV amplifier:

Connecting to External Equipment

Connecting a PC

Refer to page 35 for a list of PC signals compatible with the TV.

- When using HDMI cable (HDMI 1, 2 or 3):

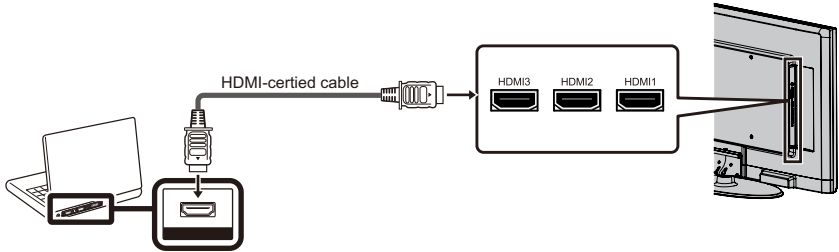

NOTE

- The HDMI terminals only support digital signal.
- When using DVI-HDMI conversion cable (HDMI 1,2,3 or PC):

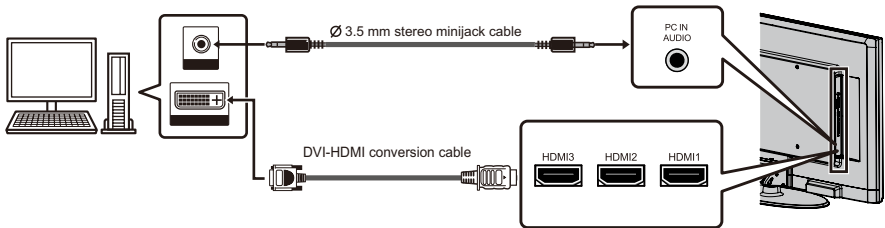

NOTE

- Digital Audio output is not available when using an HDMI input.
- Using analog audio connection by headphone jack when connecting to sound bar or external speaker.

- When using analog RGB cable (PC IN):

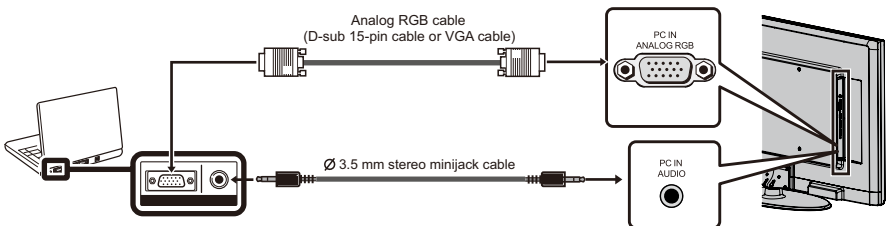

NOTE

- When using an analog RGB cable, input the audio signal to the AUDIO PC IN/HDMI terminal of PC IN.

Watching TV

Turning On/Off the Power

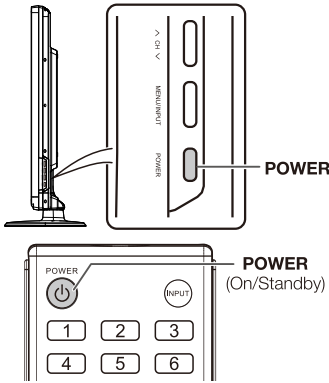

Press **POWER** on the TV, or **POWER** on the remote control unit to turn the power on.

- **POWER** indicator: Power on, Blue; Power off, red.

Press **POWER** on the TV, or **POWER** on the remote control unit again to turn the power off.

- The TV enters standby and the image on the screen disappears.

NOTE

- If you are not going to use this TV for a long period of time, be sure to remove the AC cord from the AC outlet.
- Small amount of electric power is still consumed even when the TV is turned off.
- If there is no signal input for 15 minutes, the power will turn to standby mode automatically.

Setup Wizard

When you turn on the TV for the first time, the Setup Wizard will guide you through the setup process. Perform the following steps before you press **POWER** on the remote control unit.

1. Insert the batteries into the remote control unit. (See page 11.)
2. Connect the antenna cable to the TV. (See page 10.)
3. Plug in the AC cord to the AC outlet. (See page 8.)

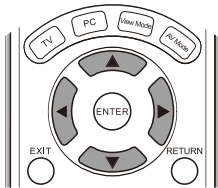

1. Setup Wizard---Picture Mode

- The Setup Wizard screen display at the first use. Press **▲/▼** to select Picture Mode.



TV Location

Select "Home" or "Store" for the location where you plan to install the TV. This product qualifies for ENERGY STAR in Home mode default setting.

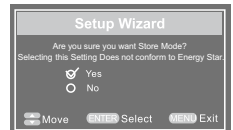
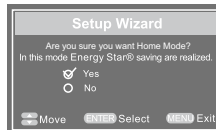

Home Mode (Energy Saving):Select Home Mode to maximize energy efficiency. Please note if you select Home Mode the picture will be darker. This mode meets the requirements of Energy Star® qualification.

Store Mode : Select Store Mode if you would like your picture to be brighter. At times this mode may use more energy to operate the Volume/Sound Mode and the Picture Mode. In this setting, the power consumption may possibly exceed the limited requirement of the Energy Star® qualification.

NOTE

Energy Star® is a set of power-saving guidelines issued by the U.S. Environmental Protection Agency(EPA). Energy Star® is a joint program of the U.S. Environmental Protection Agency and the U.S. Department of Energy helping us all save money and protect the environment through energy efficient products and practices.

- **The ON-MODE Power under Home Mode should be less than 98.7W.**
- **The SLEEP-MODE Power should be less than 0.5W.**

Watching TV

2. Language setting

- Press ▲/▼ to Select the OSD menu languages from English, French, or Spanish.
- Press ◀/▶ to select the desired language listed on the screen.



3. Air/Cable (Antenna setting)

- Make sure what kind of connection is made with your TV when selecting "Air" or "Cable".
- Press ◀/▶ to select "Air" or "Cable".



4. Cable System (Cable setting)

- Press ◀/▶ to select Cable System from among: "AUTO", "STD", "IRC" or "HRC".

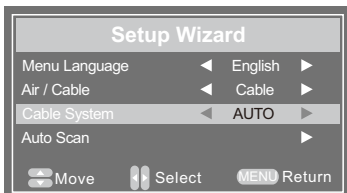

Auto Scan (Channel search)

Channel auto search makes the TV look for all channels viewable in the set area.

5. When "Air" or "Cable" is selected in Antenna setting:

Press ▲/▼ to select "AUTO Scan", and then press ▶ to start channel search.

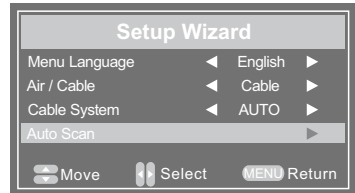

Direct Button Operation

11 Closed Captions and Digital Closed Captions

Your TV is equipped with an internal Closed Caption decoder. It allows you to view conversations, narration and sound effects as subtitles on your TV. Closed Captions are available on some TV programs and on some VHS home video tapes at the discretion of the program provider.

Digital Closed Caption service is a new caption service available only on digital TV programs (also at the discretion of the service provider). It is a more flexible system than the original Closed Caption system, because it allows for a variety of caption sizes and font styles. When the Digital Closed Caption service is in use, it will be indicated by the appearance of DTVCC.

In the Closed Caption system, there can be more than one caption service provided. Each is identified by its own number. The "CC1", "CC2", "CC3" and "CC4" services display subtitles of TV programs superimposed over the program's picture.

In the Closed Caption system, the TEXT1, TEXT2, TEXT3 or TEXT4 services display text that is unrelated to the program being viewed (e.g., weather or news). These services are also superimposed over the program currently being viewed.

Press CC

On: Displays the closed caption.

Off: Does not display the closed caption.

CC on Mute: Displays the closed caption when TV's sound is muted.

NOTE

- You can adjust the closed caption screen appearance to your preference. (See page 28.)

12 INPUT

To view external source images, select the input source by pressing **INPUT** on the remote control unit or on the TV.

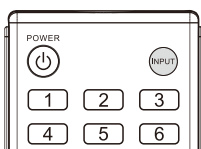

1 Press **INPUT**.

- A list of selectable sources appears.

2 Press **▲/▼** to select the input source.

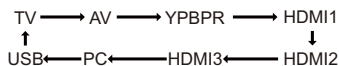

3 Press **ENTER** to confirm.

- An image from the selected source automatically displays.
- If the corresponding input is not plugged in, you cannot change the input. Be sure to connect the equipment beforehand.

NOTE

- See page 10 for external equipment connection.
- Press **PC** to switch to an image from the PC.

13 DISPLAY

Displays channel information being viewed.
Press **DISPLAY**.

14 AUDIO

■ MTS/SAP stereo mode

The TV has a feature that allows reception of sound other than the main audio for the program. This feature is called Multi-channel Television Sound (MTS). The TV with MTS can receive mono sound, stereo sound and Secondary Audio Programs (SAP). The SAP feature allows a TV station to broadcast other information, which could be audio in another language or something completely different like weather information.

You can enjoy Hi-Fi stereo sound or SAP broadcasts where available.

- Stereo broadcasts:** View programs like live sporting events, shows and concerts in dynamic stereo sound.
- SAP broadcasts:** Receive TV broadcasts in either MAIN or SAP sound. MAIN sound: The normal program soundtrack (either in mono or stereo). SAP sound: Listen to a second language, supplementary commentary or other information. (SAP is mono sound.)

If stereo sound is difficult to hear.

- Obtain a clearer sound by manually switching to fixed mono-sound mode.

You can change MTS as shown below to match the television broadcast signal.

Press **AUDIO** to toggle between audio modes.

Examples: when receiving MTS and SAP

STEREO mode: STEREO ↔ MONO

STEREO + SAP mode: STEREO → MONO → SAP

MONO mode: MONO

■ Digital broadcasting audio mode

The types of audio transmitted in a digital broadcast include SURROUND as well as MONO and STEREO. In addition, it is possible for multiple audio tracks to accompany a single video track.

1 Press **AUDIO**.

- A list of selectable audio is displayed.

2 Press **AUDIO** to select audio.

NOTE

- MTS only operates while in TV mode.

Direct Button Operation

15 MUTE

Mutes the current sound output.

Press **MUTE**.

- "⊗" will be displayed on the screen, and the sound is silenced.

NOTE

- Mute can be canceled by pressing **VOL + -** or **MUTE**.

16 Changing Volume

You can change the volume by pressing **VOL + / -** on the TV or on the remote control unit.

- To increase the volume, press **VOL +**.
- To decrease the volume, press **VOL -**.



17 AV MODE

AV Mode gives you several viewing options to choose from to best match the surrounding environment of the TV, which can vary due to factors like room brightness, type of program watched or the type of image input from external equipment.

Press **AV MODE**. Current AV Mode displays.

- Press **AV MODE** again before the mode displayed on the screen disappears. The mode changes as shown below:

Example:

When the input source is TV, AV or YPbPr terminals



Example:

When the input source is HDMI 1, 2 or 3 terminals

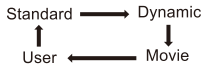

Example:

When the input source is PC terminal

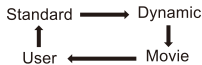

STANDARD: For a highly defined image in a normal lighting.

DYNAMIC: For a clear-cut image emphasizing high contrast, useful for sports viewing.

MOVIE: For a movie.

USER: Allows the user to customize settings as desired. You can set the mode for each input source.

NOTE

- You can select a different AV Mode item for each input mode. (For example, select STANDARD for TV input and DYNAMIC for COMPONENT.)

18 ▲/▼/◀/▶, ENTER

Select a desired item on the screen.

19 RETURN

Returns to the previous menu screen.

20 FAV

Set the favorite channels.

21 ADD/ERASE

Add or erase favorite channels.

22 ◀◀/▶▶

Press to skip between chapters.

23 ◀◀/▶▶

Press to adjust the playback speed.

24 ||

Press to pause or resume the playback.

25 ■

Press to stop the playback and clear the existing memory.

Direct Button Operation

VIEW MODE

You can select the screen size.

Press **VIEW MODE** to toggle between view modes.

For HD programs

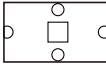
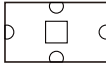
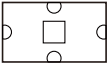
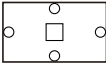
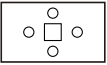
Wide	Cinema	Zoom	Full 100%	Normal
 <p>Reference signal is a 4:3, so in 16:9 signal, and about the same but 133% cut edge; enlarge If is 4:3, up and down the same signal, or so just 133% full screen amplified</p>	 <p>Full screen display, the picture up and down 132%, or so also amplifier amplification at 132%, physical resolution 16:9 screen as shown below Suitable for viewing wide-screen 2.35:1 aspect-ratio programs in full screen.</p>	 <p>Full screen display, the picture is about 133%, and the upper and lower amplifier amplification and 133%</p>	 <p>The entire frame covered with the whole screen (both 16:9 or 4:3)</p>	 <p>16:9 display, the picture is not cut side up and down, full screen, or so also don't cut edge</p>

NOTE

- When using Dot by Dot or Full Screen, it is possible to see noise or bars around different outer portions of the screen. Please change view mode to correct this.

For 4:3 programs

Example: Screen size images

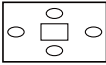
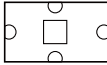
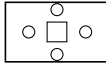
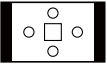
Wide	Cinema	Zoom	Normal
 <p>Full screen display, or so 133% but not enlarge images cut edge, fluctuation unchanged.</p>	 <p>Full screen display, the picture up and down 176%, 176% or so magnified, amplified.</p>	 <p>Full screen display, the picture is about 133%, and the upper and lower amplifier amplification, also 133%.</p>	 <p>4:3 display, the pictures are on either side of the black side, fluctuation don't cut edge, or so also don't cut edge.</p>

For PC input mode

NOTE

- Connect the PC before making adjustments.
- Selectable screen size may vary with input signal type.

Example: Screen size images

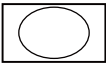
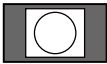
Full	Dot by Dot
 <p>An image fully fills the screen.</p>	 <p>Detects the resolution of the signal and displays an image with the same number of pixels on the screen.</p>

On-Screen Display Menu

On-Screen Display Menu Operation

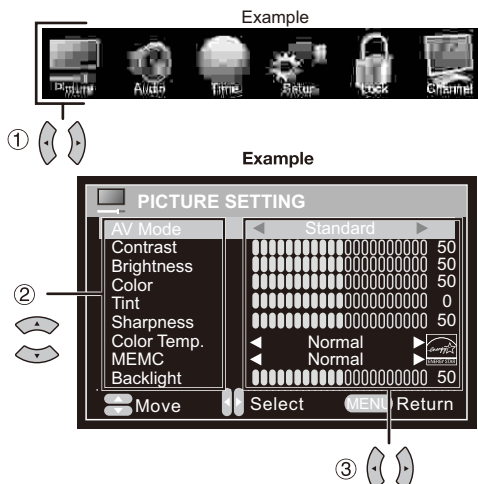

1. Press **MENU** to display the MENU screen, and press **ENTER** to select the desired menu.
2. ① Press **◀/▶** to select the desired menu.
② Press **▲/▼** to select a specific adjustment item.
③ Press **◀/▶** to select or adjust the desired setting, and then press **ENTER**.

Operations vary depending on the function or item. Refer to the guide display corresponding to the menu setting screen for button operations.

3. Press **MENU** to exit.

- ① Item displayed in yellow
 - This indicates the item currently selected.
- ② This indicates the current setting for the item.
- ③ Item displayed in white
 - This indicates that the item can be selected.
- ④ Item displayed in gray
 - This indicates that the item cannot be selected.
 - There are various reasons why the items cannot be selected, but the main reasons are as follows:
 - Nothing is connected to the selected input terminal.
 - The function is not compatible with the current input signal.

NOTE

- Menu options differ in the selected input modes, but the operating procedures are the same.
- The screens in the operation manual are for explanation purposes (some are enlarged, others cropped) and may vary slightly from the actual screens.
- The order of explanations for each menu item in the following pages is not necessarily in accordance with the alignment of the items on the screen.

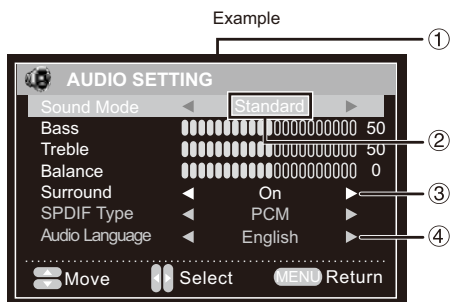

On-Screen Display Menu

Menu Operation Button

Using the remote control

Use the following buttons on the remote control to operate the menu.

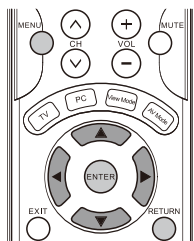

MENU: Press to open or close the menu screen.

▼/▲/▶/◀: Press to select a desired item on the screen or adjust a selected item.

ENTER: Press to go to the next step or complete the setting.

RETURN: Press to return to the previous step.

Using the control panel of the main unit

You can also operate the menu with the control panel of the main unit.

Button operations on the control panel correspond to the ones on the remote control as shown below.

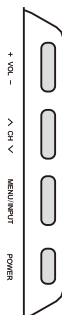

VOL +/-: Cursor ◀/▶ on the remote control.

CH ^/v: Cursor ▲/▼ on the remote control.

MENU: **MENU** on the remote control or **EXIT** on the remote control while OSD menu is on.

INPUT: **ENTER** on the remote control.

Picture Setting

Adjusts the picture to your preference with the following picture setting.

Example

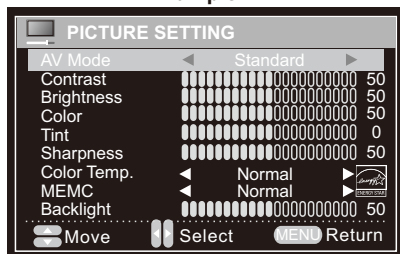

1. Press **MENU** to display the MENU screen, and then press ◀/▶ to select "Picture" and press **ENTER** to enter it.
2. Press ▲/▼ to select a specific adjustment item and press **ENTER** to enter the setting.
3. Press ◀/▶ to adjust the setting.
4. Press **MENU** to exit.

AV Mode

Select the type of picture which best corresponds to your viewing preferences by selecting Picture Mode in the PICTURE menu; press ◀/▶ to select the "Standard", "Dynamic", "Movie", "User".

Selected item	◀button	▶button
Contrast	For less contrast	For more contrast
Brightness	For less brightness	For more brightness
Color	For less color intensity	For more color intensity
Tint	Skin tones become reddish	Skin tones become greenish
Sharpness	For less sharpness	For more sharpness
Backlight	The screen dims	The screen brightens

Color Temp. (Color Temperature)

For a better white balance, use color temperature correction.

Warm: White with reddish tone

Normal: ↑

Cool: White with bluish tone

White balance can be adjusted manually through the R/G/B Gain between a maximum of 255 and a minimum of 0 for each color temperature.

On-Screen Display Menu

Audio Setting

You can adjust the sound quality to your preference with the following settings.

Example

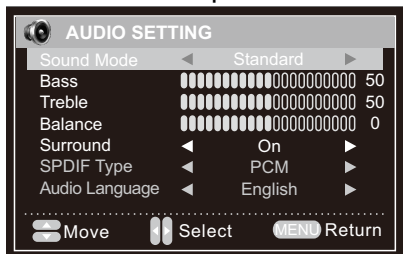

1. Press **MENU** to display the MENU screen, and then press **◀/▶** to select "Audio", and then press **ENTER** to enter it.
2. Press **▲/▼** to select a specific adjustment item.
 - Select "Treble", "Bass" or "Balance" and then press **ENTER** to set each item.
3. Press **◀/▶** to select the desired setting, and then press **ENTER**.
4. Press **MENU** to exit.

Sound Mode

Press **◀/▶** to select the "Standard", "Music", "Movie", "User".

Selected item	◀ button	▶ button
Treble	For weaker treble	For stronger treble
Bass	For weaker bass	For stronger bass
Balance	Decrease audio from the right speaker	Decrease audio from the left speaker

Surround

The surround function produces Surround effect from the speakers.

On: Makes it possible to enjoy natural, realistic surround sound.

Off: Outputs the normal sound.

NOTE

For some discs, setup may be required on your DVD/BD player. In this case, please refer to the operation manual of your DVD/BD player.

SPDIF Type

You can output digital audio to an AV amplifier or similar device whose DIGITAL AUDIO INPUT

terminal is connected to the DIGITAL AUDIO OUTPUT terminal on the TV. Please select an audio output format compatible with the audio format of the program you are watching and the equipment connected.

PCM: The optical output terminal outputs audio signal in PCM form. If your digital audio system does not support Dolby Digital, select "PCM".

RAW: The optical output terminal outputs Audio signal in Dolby Digital form. It reproduces sound from surround program of digital.

Time Setting

You can adjust the system time to your preference with the following settings.

Example

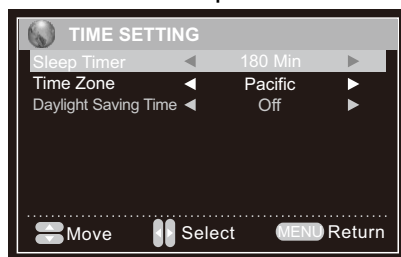

1. Press **MENU** to display the MENU screen, and then press **◀/▶** to select "Time", and then press **ENTER** to enter it.
2. Press **▲/▼** to select a specific adjustment item, and then press **◀/▶** to select the desired setting, and then press **ENTER**.
3. Press **MENU** to exit.

Sleep Timer

Press **◀/▶** to select the sleep timer from among "Off", "5 Min", "10 Min", "15 Min", "30 Min", "45 Min", "60 Min", "90 Min", "120 Min", "180 Min" or "240 Min".

Timer Zone

Press **◀/▶** to select the timer zone from among "Pacific", "Alaske", "Hawaii", "Eastern", "Central" or "Mountain".

Daylight Saving Time

Press **◀/▶** to select the daylight saving time from among "On" or "Off".

On-Screen Display Menu

Option Setting

Example

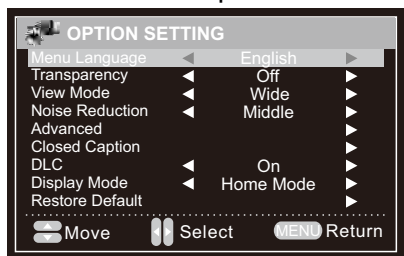

1. Press **MENU** to display the MENU screen, and then press ◀/▶ to select "Setup", and then press **ENTER** to enter it.
2. Press ▲/▼ to select a specific adjustment item.
3. Press ◀/▶ to select the desired setting, and then press **ENTER**.
4. Press **MENU** to exit.

Menu Language

Press ◀/▶ to select the menu language from among English、French or Spanish.

Transparency

Press ◀/▶ to select the transparency function from among On or Off.

View Mode

Press ◀/▶ to select the zoom from among Wide、Zoom、Cinema、Normal、Dot by Dot、Full.

Noise Reduction

Press ◀/▶ to select the a desired level for viewing a clearer video image from among Off、Weak、Middle、Strong.
Produces a clearer video image.

Strong/Middle/Weak:Select a desired level for viewing a clearer video image.

Off: No adjustment.

Advanced

Ordinarily you can easily adjust the picture as necessary to change image position using "Advance". In some cases, however, manual adjustment is needed to optimize the image.

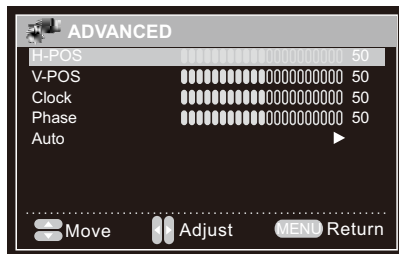

H-Pos.: Centers the image by moving it to the left or right.

V-Pos.: Centers the image by moving it up or down.

Clock: Adjust when the image flickers with vertical stripes.

Phase: Adjust when characters have low contrast or when the image flickers.

Auto: Auto adjust image position.

NOTE

The default cursor position may not be in the center, because the screen position variable ranges may be asymmetrical.

The screen position variable ranges depend on the View Mode or the signal type. The ranges can be seen on the position-setting screen.

Closed Caption

Allow you to change the Closed Caption display

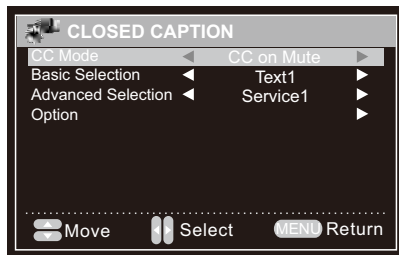

CC Mode: Allow you to select the CC Mode among: On、Off .

Basic Selection: Allow you to select the basic selection among: CC1、CC2、CC3、CC4、Text1、Text2、Text3 and Text4.

Advanced Selection: Allow you to select the advanced selection among: Service1、Service2、Service3、Service4、Service5 or Service6、

On-Screen Display Menu

Option: This function allow you to adjust the caption screen appearance to suit your preference.



DLC

Press ◀/▶ to select the DLC (Dynamic Luminance Control) from On or Off.

Display Mode

Press ◀/▶ to select the Home Mode or Store Mode.

Restore Default



If complex adjustments are made and the settings cannot be restored to normal, you can reset the settings to the factory preset values.

NOTE

The Channel Setup settings will not be changed.
 The Language settings will not be changed.
 The Secret number settings will not be changed.
 The TV Location settings will not be changed.

Lock Setting

Allows you to use a secret number to protect certain settings from being accidentally changed.

Example

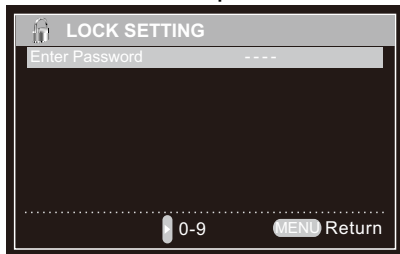

1. Press **MENU** to display the MENU screen, and then press ◀/▶ to select "Lock", and then press **ENTER** to enter it.
2. Press ▼ to enter the "Enter Password" selection and use the numeric keys to input a 4-digit password. The screen will display the sub-menu, after setting.
3. Press **MENU** to exit.

NOTE

The factory password is 0000.

Change Password

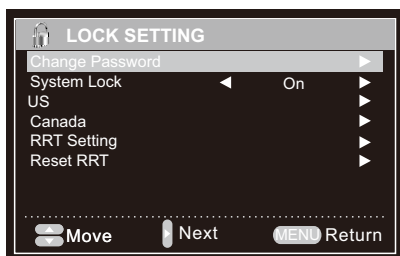

On-Screen Display Menu

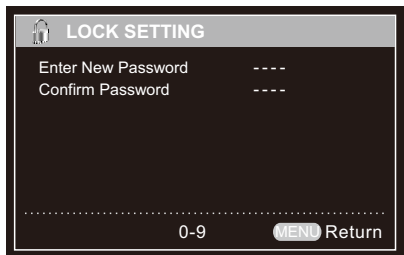

Enter New Password: Enter a 4-digit Secret No. with the number buttons on the remote control to change your password.

Confirm Password: enter your new 4-digit Secret No. again to confirm.

NOTE

As a precautionary measure, make a note of your secret number and keep it in a familiar place.

System Lock

Press ◀/▶ to select the system lock from On or Off, if you turn off the system lock, then the following options (US, Canada, RRT Setting and Reset RRT) are unavailable for use.

US rating

Press ▶ to enter into US rating following menu.

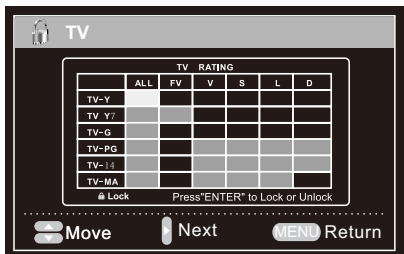
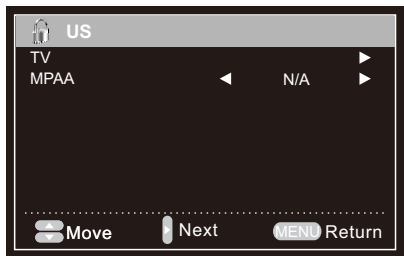

TV Parental Guidelines

• Suggested age

TV-Y: All children.

TV-Y7: Directed to older children.

TV-G: General audience.

TV-PG: Parental Guidance suggested.

TV-14: Parents strongly cautioned.

TV-MA: Mature audience only.

• Content

FV: Fantasy violence.

V: Violence.

S: Sexual situation.

L: Adult language.

D: Sexually suggestive dialog.

MPAA (Motion Picture Association of America)

The Movie rating (MPAA) is used for original movies rated by the Motion Picture Association of America as broadcasted on cable TV and not edited for television.

G: General audiences. All ages admitted.

PG: Parental guidance suggested. Some material may not be suitable for children.

PG-13: Parents strongly cautioned. Some material may be inappropriate for children under 13.

R: Restricted. Under 17 requires accompanying parent or adult guardian (age varies in some jurisdictions).

NC-17: No one 17 and under admitted.

X: X is an older rating that is unified with NC-17 but may be encoded in the data of older movies.

Canada Rating

Press ▶ to enter into Canada rating following menu.



Canada English

E: Exempt: Includes news, sports, documentaries and other information programming; talk shows, music videos, and variety programming.

C: Children: Intended for younger children under the age of 8 years. Pays careful attention to themes that could threaten their sense of security and well-being.

On-Screen Display Menu

C8+: Children over 8 years old: Contains no portrayal of violence as the preferred, acceptable, or only way to resolve conflict; nor encourage children to imitate dangerous acts which they may see on the screen.

G: General: Considered acceptable for all age groups. Appropriate viewing for the entire family, contains very little violence, physical, verbal or emotional.

PG: Parental Guidance: Intended for a general audience, but may not be suitable for younger children (under the age of 8) because it could contain controversial themes or issues.

14+: Over 14 years: Could contain themes where violence is one of the dominant elements of the storyline, but it must be integral to the development of plot or character. Language usage could be profane and nudity present within the context of the theme.

18+: Adults: Intended for viewers 18 years and older and might contain depictions of violence, which while related to the development of plot, character or themes, are intended for adult viewing. Could contain graphic language and portrayals of sex and nudity.

■ Canada French

E: Exempt programming.

G: General: All ages and children, contains minimal direct violence, but may be integrated into the plot in a humorous or unrealistic manner.

8ans+: General but inadvisable for young children: May be viewed by a wide public audience, but could contain scenes disturbing to children under 8 who cannot distinguish between imaginary and real situations. Recommended for viewing with parent.

13ans+: Over 13 years: Could contain scenes of frequent violent scenes and therefore recommended for viewing with parent.

16ans+: Over 16 years: Could contain frequent violent scenes and intense violence.

18ans+: Over 18 years: Only for adult viewing. Could contain frequent violent scenes and extreme violence.

RRT Setting

Rating Region Table setting, Press **▶** to enter into RRT setting menu.

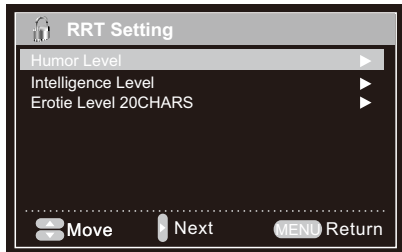

Reset RRT

Allows you to reset the RRT setting.

Channel Setting

Example

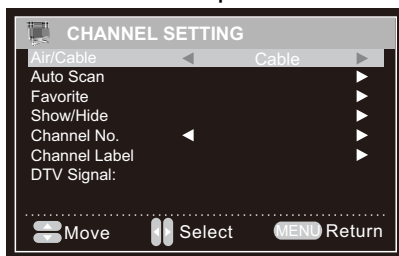

1. Press **MENU** to display the MENU screen, and then press **◀/▶** to select "Channel", then press **ENTER** to enter it.
2. Press **▲/▼** to select a specific adjustment item.
3. Press **◀/▶** to select the desired setting, and then press **ENTER**.
4. Press **MENU** to exit.

Air / Cable

- Make sure what kind of connection is made with your TV when selecting "Air" or "Cable".
- Press **◀/▶** to select "Air" or "Cable".

Auto Scan

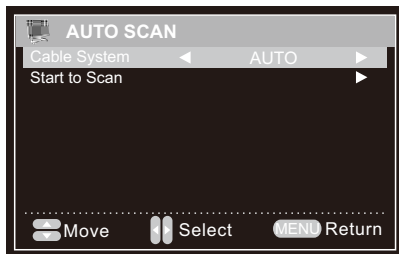

If you select "Air" as the input signal in "Antenna" item, and then press the **▶** to search channels automatically. The receivable channels will be stored automatically. when searching channels, press **MENU** to stop.

If you select "Cable" as the input signal in "Antenna" item, you can select Cable System from among: AUTO、STD、IRC or HRC; and then press **▲/▼** to "Start to Scan", then press the **▶** to search channels automatically. The receivable channels will be stored automatically. when searching channels, press **MENU** to stop.

On-Screen Display Menu

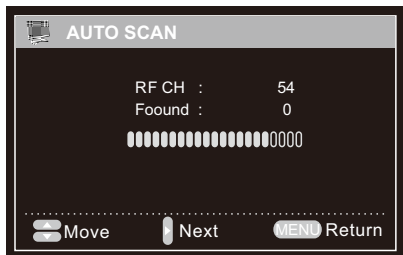

Channel No.

Display the number of current channel.

Channel Label

Display the label of current channel.

DTV Signal

Display the quality of current DTV signal.

Favorite

Allows you to add channels that you flag to your favorite channel list.

Press the ▲ / ▼ to select "Favorite" item, then press the ► to enter into the menu.

Press the ▲ / ▼ to select the desired channel, then press the "ENTER" to add or remove the desired channel as a favorite.

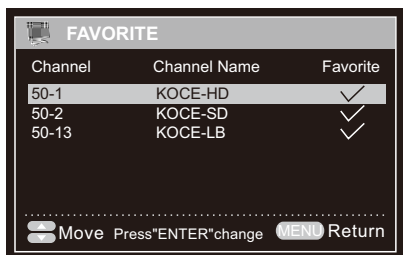

Show/Hide

Allows you to Show or Hide the channel.

Press the ▲ / ▼ to select "Show/Hide" item, then press the ► to enter into the menu.

Press the ▲ / ▼ to select the desired channel, then press the "ENTER" to show or hide the channel.

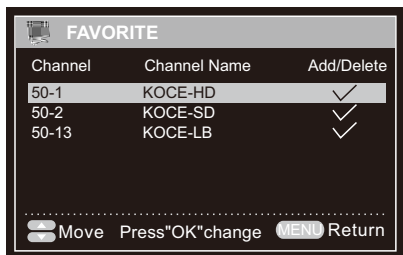

Enjoying Photo/Music/Movie Playback

You can connect the TV to a USB memory device, USB hard drive to enjoy viewing pictures, listening to music and watching movies.

NOTE

- Depending on the USB memory device/USB hard drive, the TV may not be able to recognize the recorded data.
- It may take time to read the recorded data if the USB memory device/USB hard drive contains many files or folders.
- Only support FAT format and unpartitioned USB device.
- Exit the USB mode by pressing INPUT on the remote control unit or on the TV then press ▲/▼ buttons to select the desired input source and press Enter to confirm.

Connecting a USB Memory Device/USB Hard Drive

Insert the USB memory device with recorded photos, music or movie into the USB terminal on the TV.

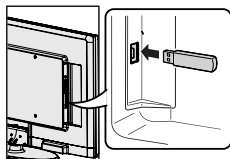

USB Device Compatibility

USB device	USB Memory, USB card reader (Mass Storage class), USB hard drive
File system	FAT/FAT32(USB hard drive only)
Photo file format	.jpg, .jpeg, .bmg, .png
Music file format	.mp3, .wma, .m4a, .aac
Movie file format	.avi, .mp4, .ts, .trp, .mpg, .mkv, .mov, .dat, .vob, .rm, .rmvb

Listening to Music

- Press the **INPUT** button on the main unit or on the remote control then press the ▲/▼ buttons to select the **USB** mode and then press **Enter** button.
- Press the ◀/▶ buttons to select **MUSIC** and then press **Enter** button.

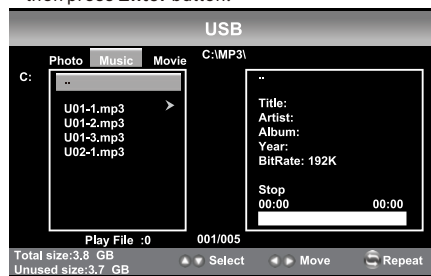

Viewing Pictures

- Press the **INPUT** button on the main unit or on the remote control then press the ▲/▼ buttons to select the USB mode and then press **Enter** button.
- Press the ◀/▶ buttons to select **PHOTO** and then press **Enter** button.

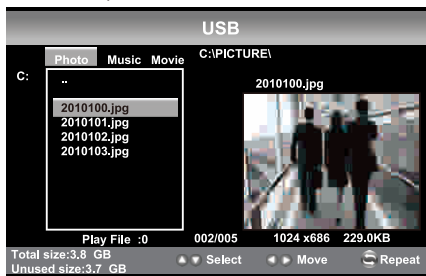

Watching Movie

- Press the **INPUT** button on the main unit or on the remote control then press the ▲/▼ buttons to select the USB mode and then press **ENTER** button.
- Press the ◀/▶ buttons to select **MOVIE** and then press **ENTER** button.



Buttons	Description
▲/▼/◀/▶	Select a desired item.
ENTER	When selecting a folder icon: Enter this directory. When selecting a photo thumbnail: view picture . When selecting a music file: Play music. When selecting a movie file: watch movie .
Return	Return to the previous process.

Appendix

Troubleshooting

Problem	Possible Solution
<ul style="list-style-type: none"> No power 	<ul style="list-style-type: none"> Check if you pressed POWER on the remote control unit. (See page 19.) If the indicator on the TV is still red, press POWER on the TV. Is the AC cord disconnected? (See page 8.) Has the power been turned on? (See page 19.)
<ul style="list-style-type: none"> Unit cannot be operated. 	<ul style="list-style-type: none"> External influences such as lightning, static electricity, may cause improper operation. In this case, operate the unit after First turning off the power of the TV or unplugging the AC cord and re-plugging it after 1 or 2 minutes.
<ul style="list-style-type: none"> Remote control unit does not operate. 	<ul style="list-style-type: none"> Are batteries inserted with polarity (+ , -) aligned? (See page 11.) Are batteries worn out? (Replace with new batteries.) Are you using it under strong or fluorescent lighting? Is a fluorescent light illuminated near the remote control sensor?
<ul style="list-style-type: none"> Picture is cut off/with sidebar screen. 	<ul style="list-style-type: none"> Are screen mode adjustments such as picture size made correctly? (See page 24.)
<ul style="list-style-type: none"> Strange color, light color, or color misalignment 	<ul style="list-style-type: none"> Adjust the picture tone. (See page 26.) Is the room too bright? The picture may look dark in a room that is too bright.
<ul style="list-style-type: none"> Power is suddenly turned off. 	<ul style="list-style-type: none"> Is the sleep timer set? (See page 21.) The unit's internal temperature has increased. Remove any objects blocking vent.
<ul style="list-style-type: none"> No picture 	<ul style="list-style-type: none"> Is connection to other components correct? (See page 14.) Is the correct input selected? (See page 14 or 22.)
<ul style="list-style-type: none"> No sound 	<ul style="list-style-type: none"> Is the volume too low? (See page 23.) Have you pressed MUTE on the remote control unit? (See page 23.)
<ul style="list-style-type: none"> The TV sometimes makes a cracking sound. 	<ul style="list-style-type: none"> This is not a malfunction. This happens when the cabinet slightly expands and contracts according to change in temperature. This does not affect the TV's performance.

The Master Password

If you forgot the password number, reset the secret number by following the procedures below:

- Press **MENU** to display the MENU screen, and then press ◀ / ▶ select **Lock** and then press **ENTER** to enter it.
- Press the master password 8899.

NOTE

- As a precautionary measure, make a note of your secret number and keep it in a safe place.

Appendix

Cautions regarding use in high and low temperature environments

- When the unit is used in a low temperature space (e.g. room, office), the picture may leave trails or appear slightly delayed. This is not a malfunction, and the unit will recover when the temperature returns to normal.
- Do not leave the unit in a hot or cold location. Also, do not leave the unit in a location exposed to direct sunlight or near a heater, as this may cause the cabinet to deform and the Liquid Crystal panel to malfunction.
Storage temperature: -4°F to +140°F (-20°C to +60°C)

Specifications

Item		Model:LC-60LE450U/LC-60LE452U	
LCD panel	Size	60" Class (60 1/32" Diagonal)	
	Resolution	2,073,600 pixels (1920 x 1080)	
TV Function	TV-standard (CCIR)	American TV Standard ATSC/NTSC System	
	Receiving Channel	VHF/UHF	VHF 2-13ch, UHF 14-69ch
		CATV	1-135ch (non-scrambled channel only)
		Digital Terrestrial Broadcast (8VSB)	2-69ch
		Digital cable ¹ (64/256 QAM)	1-135ch (non-scrambled channel only)
Audio multiplex	BTSC System		
Audio out		8 W x 2	
Terminals	Side	OUTPUT	Audio out
		VIDEO	AV in
		COMPONENT	Component in
		USB	Photo/Music mode/Software update
		HDMI 1	HDMI in with HDCP
		HDMI 2	HDMI in with HDCP
		HDMI 3	HDMI in with HDCP
		PC IN	ANALOG RGB (PC) in (15-pin mini D-sub female connector), Audio in (Ø 3.5 mm stereo jack)
		ANT/CABLE	75 Unbalance, F Type x 1 for Analog (VHF/UHF/CATV)
DIGITAL AUDIO OUTPUT	Optical Digital audio output x 1 (PCM/Dolby Digital)		
OSD language		English/French/Spanish	
Power Requirement		AC 120V, 60Hz	
Power Consumption		157 W (0.5W Standby with AC 120V)	
Weight	TV + stand	69 lbs./32 kg	
	TV only	60.6 lbs./28 kg	
Dimension ² (W x H x D)	TV + stand	54 ²⁵ / ₃₂ x 35 ¹² / ₃₂ x 13 inch	
	TV only	54 ²⁵ / ₃₂ x 32 ²² / ₃₂ x 4 ⁵ / ₃₂ inch	
Operating temperature		+32°F to +104°F (0°C to +40°C)	

¹ Emergency alert messages via Cable are unreceivable.

² The dimensional drawings are shown on the inside back cover.

- As part of policy of continuous improvement, SHARP reserves the right to make design and specification changes for product improvement without prior notice. The performance specification figures indicated are nominal values of production units. There may be some deviations from these values in individual units.

Appendix

PC Compatibility Chart

It is necessary to set the PC correctly to display XGA and WXGA signal.

PC	Resolution		Horizontal Frequency	Vertical Frequency	VESA Standard
PC	VGA	720 x 400	31.5 kHz	70.0 Hz	
		640 x 480	31.5 kHz	60.0 Hz	O
	SVGA		800 x 600	37.5 kHz	75.0 Hz
		37.9 kHz		60.0 Hz	O
		48.1 kHz		72.0 Hz	O
		46.9 kHz		75.0 Hz	O
	XGA	1024 x 768	48.4 kHz	60.0 Hz	O
			56.5 kHz	70.0 Hz	O
			60.0 kHz	75.0 Hz	O
	WXGA	1366 x 768	47.7 kHz	60.0 Hz	O
	SXGA	1280 x 1024	64.0 kHz	60.0 Hz	O
	SXGA+	1400 x 1050	65.3 kHz	60.0 Hz	O
	UXGA	1600 x 1200	75.0 kHz	60.0 Hz	O
	1080p	1920 x 1080	67.5 kHz	60.0 Hz	

VGA and XGA are registered trademarks of International Business Machines Corp.

Appendix

Wall Mount Kit Specifications

Standard dimensions for wall mount kits are shown below.
 (The illustration is based on the LC-80LE857U model as an example)

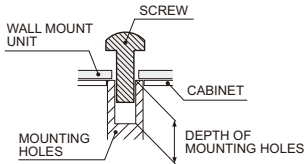
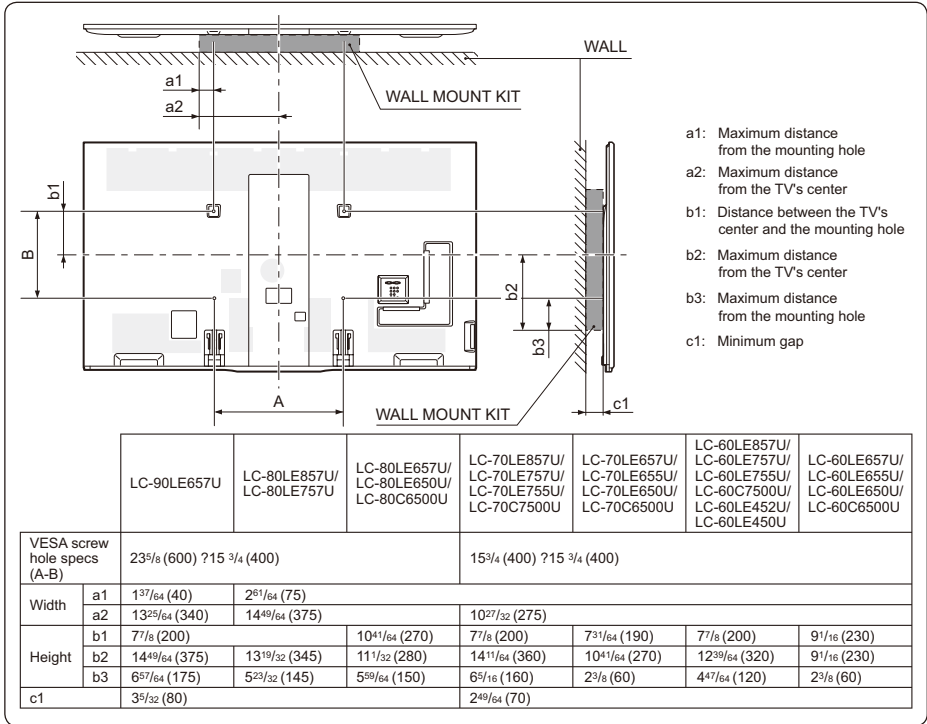

Do not install the wall mount kit while your TV is turned on. It may result in personal injury due to electric shock.

For the screws, refer to the table shown below.

	90/80 inch models	70/60 inch models
Standard screws	M8 (Use 1.25 pitch screws)	M6 (Use 1.0 pitch screws)
Length(Depth of mounting holes)	1 ⁵ / ₃₂ (12)	
Quantity	4 pcs.	

NOTE

- Do not mount the TV at a tilt.
- To use this TV mounted on a wall, remove the cable tie as needed.
- Do not use screws that do not comply with the VESA standard screw specifications.
- Do not use screws that are longer than the standard length. Screws that are too long may cause damage to the inside of the TV.
- Do not fasten the screws too firmly or loosely. This may damage the product or cause the product to fall, leading to personal injury. SHARP is not liable for these kinds of accidents.
- SHARP is not liable for product damage or personal injury when a non-VESA or non-specified wall mount is used or the consumer fails to follow the product installation instructions.

Legal notices

■FCC Part 15

This device complies with Part 15 of the FCC Rules. Operation of this product is subject to the following two conditions: (1) this device may not cause harmful interference, and (2) this device must accept any interference received, including interference that may cause undesired operation.

This equipment has been tested and found to comply within the limits for a class B digital device, pursuant to Part 15 of the FCC Rules. These limits are designed to provide reasonable protection against harmful interference in a residential installation. This equipment generates, uses, and can radiate radio frequency energy and, if not installed and used in accordance with the instructions, may cause harmful interference to radio communications. However, there is no guarantee that interference will not occur in a particular installation. If this equipment does cause harmful interference to radio or television reception, which can be determined by turning the equipment off and on, the user is encouraged to try to correct the interference by one or more of the following measures:

- Reorient or relocate the receiving antenna.

- Increase the separation between the equipment and receiver.

- Connect the equipment into an outlet on a circuit different from that to which the receiver is connected.

- Consult the dealer or an experienced radio/TV technician for help.

■FCC warning

Changes or modifications not expressly approved by the party responsible for compliance with the FCC Rules could void the user's authority to operate this equipment.

■Cables

Connections to this device must be made with shielded cables with metallic RF/EMI connector hoods to maintain compliance with FCC Rules and Regulations.

■Canadian notice

This Class B digital apparatus complies with Canadian ICES-003.

Cet appareil numérique de la classe B est conforme à la norme NMB-003 du Canada.

“Standard Television Receiving Apparatus-Appareil de réception télévision ordinaire, Canada BETS-7 / NTMR-7”.

Calling for Service

For location of the nearest Sharp Authorized Service, or to obtain product literature, accessories, supplies, or customer assistance, please call 1-800-BE-SHARP.

LIMITED WARRANTY

CONSUMER LIMITED WARRANTY

SHARP ELECTRONICS CORPORATION warrants to the first consumer purchaser that this Sharp brand Liquid Crystal Display product (the "Product"), when shipped in its original container, will be free from defective workmanship and materials, and agrees that it will, at its option, either repair the defect or replace the defective Product or part thereof with a new or remanufactured equivalent at no charge to the purchaser for parts or labor for the period(s) set forth below.

This warranty does not apply to any appearance items of the Product or if the serial number or model number affixed to the Product has been removed, defaced, changed, altered or tampered with. This warranty does not cover installation or signal reception problems. This limited warranty will not apply if the Product has been or is being used in a commercial setting or application; this warranty is meant solely for the non-commercial, household use of the Product by consumers in their home or residence. If you intend to or already use this Product for commercial purposes or in a commercial setting, there are warranties available to cover your use of this Product, the terms of which may vary. Please contact **1-800-BE-SHARP** for further information.

In order to enforce your rights under this limited warranty, you should follow the steps set forth below. You must be able to provide proof of purchase to the servicer, which proof must include the date of purchase.

To the extent permitted by applicable state law, the warranties set forth are in lieu of, and exclusive of, all other warranties, express or implied. Specifically ALL OTHER WARRANTIES OTHER THAN THOSE SET FORTH ABOVE ARE EXCLUDED, ALL EXPRESS AND IMPLIED WARRANTIES INCLUDING THE WARRANTIES OF MERCHANTABILITY, FITNESS FOR USE, AND FITNESS FOR A PARTICULAR PURPOSE ARE SPECIFICALLY EXCLUDED. IF, UNDER APPLICABLE STATE LAW, IMPLIED WARRANTIES MAY NOT VALIDLY BE DISCLAIMED OR EXCLUDED, THE DURATION OF SUCH IMPLIED WARRANTIES IS LIMITED TO THE PERIOD(S) FROM THE DATE OF PURCHASE SET FORTH BELOW. THIS WARRANTY GIVES YOU SPECIFIC LEGAL RIGHTS. YOU MAY ALSO HAVE OTHER RIGHTS WHICH VARY FROM STATE TO STATE.

The warranties given herein shall be the sole and exclusive warranties granted by Sharp and shall be the sole and exclusive remedy available to the purchaser and only for the time periods set forth herein. No other representations or promises made by anyone are permitted. Correction of defects, in the manner and for the period of time described herein, shall constitute complete fulfillment of all liabilities and responsibilities of Sharp to the purchaser with respect to the Product, and shall constitute full satisfaction of all claims, whether based on contract, negligence, strict liability or otherwise. Sharp does not warrant nor shall Sharp be liable, or in any way responsible, for Products which have been subject to abuse (including, but not limited to, improper voltage), accident, misuse, negligence, lack of reasonable care, alteration, modification, tampering, misuse, improper operation or maintenance or any damages or defects in the Product which were caused by repairs or attempted repairs performed by anyone other than a Sharp authorized servicer. Nor shall Sharp be liable or in any way responsible for any incidental or consequential economic or property damage. Some states do not allow limits on warranties or on remedies for breach in certain transactions; in such states, the limits herein may not apply.

THIS LIMITED WARRANTY IS VALID ONLY IN THE FIFTY (50) UNITED STATES, THE DISTRICT OF COLUMBIA, AND PUERTO RICO

Model Specific Section

Your Product Model Number & Description:

LC-60LE450U/LC-60LE452U LCD Color Television
(Be sure to have this information and Proof of Purchase available when you need service for your Product.)

Warranty Period for this Product:

One (1) year parts and labor from date of purchase.

Additional Exclusions from Warranty Coverage (if any):

Image Retention resulting from a fixed image being displayed for long periods of time is not covered by this Limited Warranty (see Operation Manual on how to prevent this).

What to do to Obtain Service:

Service is provided by a Sharp Authorized Service Center in the United States. To find the location of the nearest Sharp Authorized Service Center, call Sharp toll free at 1-800-BE-SHARP. Sharp will provide instructions on service options available for your Product.

If it is deemed the Product is to be shipped for servicing, be sure it is insured and packaged securely. Please use two persons to carry the Product, transport it in original packaging or packaging that provides comparable protection of the Product, and ensure that the Product is covered to avoid scratches and damage. Sharp shall not be responsible for lost, stolen or misdirected mail or for damage to the product incurred during shipping.

For Products that are deemed in home service, a servicer will come to your location. If necessary, the servicer may remove the unit for repair at the service facility and return it once completed. In home service is not available in all areas and Sharp may, at our option, elect to provide transportation of the Product to and from an Authorized Service Center in those areas.

TO OBTAIN PRODUCT INFORMATION OR PURCHASE ACCESSORIES, CALL **1-800-BE-SHARP** OR VISIT www.SharpUSA.com

SHARP®

LIMITED WARRANTY

Consumer Electronics Products

Congratulations on your purchase!

Sharp Electronics of Canada Ltd. ("Sharp") warrants to the first purchaser for this Sharp brand product ("Product"), when shipped in its original container and sold or distributed in Canada by Sharp or by an authorized Sharp dealer, and Product was not sold "as is" or "sales final" that the Product will during the applicable warranty period, be free from defects in material and workmanship, and will within the applicable warranty period, either repair the defective Product or provide the first purchaser a replacement of the defective Product.

Conditions: This limited warranty shall not apply to:

- Any defects caused or repairs required as a result of abusive operation, negligence, accident, improper installation or inappropriate use as outlined in the owner's manual or other applicable Product documentation.
- Any defects caused or repairs required as a result of any Product that has been tampered with, modified, adjusted or repaired by any person other than Sharp, a Sharp authorized service centre or a Sharp authorized servicing dealer.
- Any defects caused or repairs required as a result of the use of the Product with items not specified or approved by Sharp, including but not limited to, head cleaning tapes and chemical cleaning agents.
- Any replacement of accessories, glassware, consumable or peripheral items required through normal use of the Product, including but not limited to, earphones, remote controls, AC adapters, batteries, temperature probe, trays, filters, belts, ribbons, cables and paper.
- Any cosmetic damage to the Product surface or exterior that has been defaced or caused by normal wear and tear.
- Any defects caused or repairs required as a result of damage caused by any external or environmental conditions, including but not limited to, transmission line/power line voltage or liquid spillage or acts of God.
- Warranty claims for Products returned with illegible or without appropriate model, serial number and CSA/cUL markings.
- Any Products used for rental or commercial purposes.
- Any installation, setup and/or programming charges.

How to get service: Warranty service may be obtained upon delivery of the Product, together with proof of purchase (including date of purchase) and a copy of this limited warranty statement, to an authorized Sharp service centre or an authorized Sharp servicing dealer. In home warranty service will be carried out to locations accessible by on-road service vehicle and within 50 km of an authorized Sharp service centre on any Sharp Television with the screen size of 42" or larger and on any Sharp Over-The-Range Microwave Oven or Home Use Microwave Drawer. No other person (including any Sharp dealer or service centre) is authorized to extend, enlarge or transfer this warranty on behalf of Sharp. The purchaser will be responsible for any and all removal, reinstallation, transportation and insurance costs incurred.

The express warranties in this limited warranty are, except for consumer purchasers domiciled in Quebec, in lieu of and, except to the extent prohibited by applicable law, Sharp disclaims all other warranties and conditions, express or implied, whether arising by law, statute, by course of dealing or usage of trade, including, without limitation, implied warranties or conditions of merchantability and/or quality, fitness for a particular use or purpose, and/or non-infringement. **Limitations** (not applicable to consumer purchasers domiciled in Quebec to the extent prohibited under Quebec law): (a) Sharp shall not be liable for any incidental, special, consequential, economic, exemplary or indirect damages of any kind or nature (including lost profits or damages for loss of time or loss of use or loss of data) arising from or in any connection with the use or performance of a Product or a failure of a Product, even if Sharp is aware of or has been advised of the possibility of such damages; (b) the remedies described in this limited warranty constitute complete fulfillment of all obligations and responsibilities of Sharp to the purchaser with respect to the Product and shall constitute full satisfaction of all claims, whether based on contract, negligence, strict liability or otherwise. Some provinces may not allow the exclusion or limitation of certain damages, or limits on the duration or voiding of implied warranties or conditions; in such provinces, the exclusions and limits herein may not apply. This limited warranty is, except for consumer purchasers domiciled in Quebec, governed by the laws of the Province in Canada in which the purchaser has purchased the Product. For consumer purchasers domiciled in Quebec this limited warranty is governed by the laws of Quebec.

WARRANTY PERIODS (calculated from the date of original purchase): Parts & Labour (exceptions noted)

Audio Product	1 year
Blu-Ray Product	1 year
Projector	1 year (lamp 90 days)
LCD TV	1 year
Microwave Oven	1 year (magnetron component-4 additional years)
Air Purifier	1 year
Portable Air Conditioner	1 year
Plasmacluster Ion Generator	1 year
3D Glasses	1 year
Wireless LAN Adapter	1 year

To obtain the name and address of the nearest Authorized Sharp Service Centre or Dealer, or for more information on this Limited Warranty, Sharp Extended Warranty Offers, Sharp Canada Products or Accessory Sales, please contact Sharp:

- By writing to Sharp Electronics Of Canada Ltd. at 335 Britannia Road East
Mississauga, Ontario L4Z 1W9
- Calling: at 905-568-7140
- Visiting our Web site: www.sharp.ca

SHARP

THIS LIMITED WARRANTY IS VALID ONLY IN CANADA

Revision 01/01/12