



4" Outdoor Dome Series Hardware Manual

D71, D72, D81, D82, E71, E72, E73,
E74, E81, E82, E83, E84, E85, E86

2013/12/11



ACTi
Connecting Vision

Table of Contents

Precautions 4

Safety Instructions 6

Introduction 7

The List of Models 7
Package Contents 8
Physical Description 9
Mounting Options 10
 Other Mounting Accessories 12

Installing the Camera on a Surface 13

Step 1: Drill the Holes 13
Step 2: Open the Dome Cover 14
Step 3: Prepare for Waterproof Installation 15
 Waterproof Solution with Naked Cable 16
 Waterproof Solution with Conduit 18
Step 4: Install the Camera to the Surface 21
Step 5: Connect the Cable 22
Step 6: Access the Camera Live View 23
Step 7: Adjust the Viewing Angle and Focus 23
Step 8: Close the Dome Cover 23

Other Adjustments and Accessories 24

Focus and Viewing Angle Adjustments 24
 D7x / E7x Series 24
 D8x / E8x Series 26

Replacing the Dome Cover 27

Accessing the Camera 30

Configure the IP Addresses 30

Access the Camera..... 34

Precautions

Read these instructions

You should read all the safety and operating instructions before using this product.

Heed all warnings

You must adhere to all the warnings on the product and in the instruction manual. Failure to follow the safety instruction given may directly endanger people, cause damage to the system or to other equipment.

Servicing

Do not attempt to service this video device yourself as opening or removing covers may expose you to dangerous voltage or other hazards. Refer all servicing to qualified service personnel.

Trademarks

All names used in this manual are probably registered trademarks of respective companies.

Liability

Every reasonable care has been taken during the writing of this manual. Please inform your local office if you find any inaccuracies or omissions. We cannot be held responsible for any typographical or technical errors and reserve the right to make changes to the product and manuals without prior notice.

Federal Communications Commission Statement



This equipment has been tested and found to comply with the limits for a class B digital device, pursuant to Part 15 of the FCC Rules. These limits are designed to provide reasonable protection against harmful interference in a residential installation. This equipment generates, uses, and can radiate radio frequency energy and, if not installed and used in accordance with the instructions, may cause harmful interference to radio communications. However, there is no guarantee that interference will not occur in a particular installation. If this equipment does cause harmful interference to radio or television reception, which can be determined by turning the equipment off and on, the user is encouraged to try to correct the interference by one or more of the following measures:

- Reorient or relocate the receiving antenna.
- Increase the separation between the equipment and receiver.
- Connect the equipment into an outlet on a circuit different from that to which the receiver is connected.
- Consult the dealer or an experienced radio/TV technician for help.

Warning: Changes or modifications to the equipment that are not expressly approved by the responsible party for compliance could void the user's authority to operate the equipment.

European Community Compliance Statement



This product has been tested and found to comply with the limits for Class B Information Technology Equipment according to European Standard EN 55022 and EN 55024. In a domestic environment, this product may cause radio interference in which cause the user may be required to take adequate measures.

Safety Instructions

Cleaning

Disconnect this video product from the power supply before cleaning.

Attachments

Do not use attachments not recommended by the video product manufacturer as they may cause hazards.

Do not use accessories not recommended by the manufacturer

Only install this device in a dry place protected from weather

Servicing

Do not attempt to service this video product yourself. Refer all servicing to qualified service personnel.

Damage Requiring service

Disconnect this video product from the power supply immediately and refer servicing to qualified service personnel under the following conditions.

- 1) When the power-supply cord or plug is damaged
- 2) If liquid has been spilled, or objects have fallen into the video product.
- 3) If the inner parts of video product have been directly exposed to rain or water.
- 4) If the video product does not operate normally by following the operating Instructions in this manual. Adjust only those controls that are covered by the instruction manual, as an improper adjustment of other controls may result in damage, and will often require extensive work by a qualified technician to restore the video product to its normal operation.















Safety Check

Upon completion of any service or repairs to this video product, ask the service technician to perform safety checks to determine if the video product is in proper operating condition.

Introduction

The List of Models







This hardware manual contains the following models:

D71		1MP Outdoor Dome with D/N, IR, Fixed lens
D72		3MP Outdoor Dome with D/N, IR, Fixed lens
D81		1MP Outdoor Dome with D/N, IR, Vari-focal lens
D82		3MP Outdoor Dome with D/N, IR, Vari-focal lens
E71		1MP Outdoor Dome with D/N, IR, Basic WDR, Fixed lens
E72		3MP Outdoor Dome with D/N, IR, Basic WDR, Fixed lens
E73		5MP Outdoor Dome with D/N, IR, Basic WDR, Fixed lens
E74		3MP Outdoor Dome with D/N, IR, Superior WDR, Fixed lens
E81		1MP Outdoor Dome with D/N, IR, Basic WDR, Vari-focal lens
E82		3MP Outdoor Dome with D/N, IR, Basic WDR, Vari-focal lens
E83		5MP Outdoor Dome with D/N, IR, Basic WDR, Vari-focal lens
E84		2MP Outdoor Dome with D/N, IR, Basic WDR, SLLS, Vari-focal lens
E85		1MP Outdoor Dome with D/N, IR, Superior WDR, Vari-focal lens
E86		3MP Outdoor Dome with D/N, IR, Superior WDR, Vari-focal lens

From the installation perspective these models are very similar; therefore you can use one manual for all of them.

Package Contents

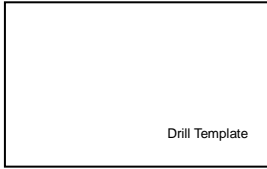
D7x / D8x / E7x / E8x Series

<p>Camera (D7x / E7x Series)</p> 		<p>or</p>		<p>Camera (D8x / E8x Series)</p> 	
<p>Mounting Screw Kit</p> 		<p>Conduit Gland</p> 		<p>Cable Gland</p> 	
<p>Hexagon Screwdriver (Available in select models only)</p> 		<p>Lens Focus Tuner (for D7x / E7x series only)</p> 		<p>Drill Template</p> 	
<p>Quick Installation Guide</p> 		<p>Warranty Card</p> 			

Physical Description

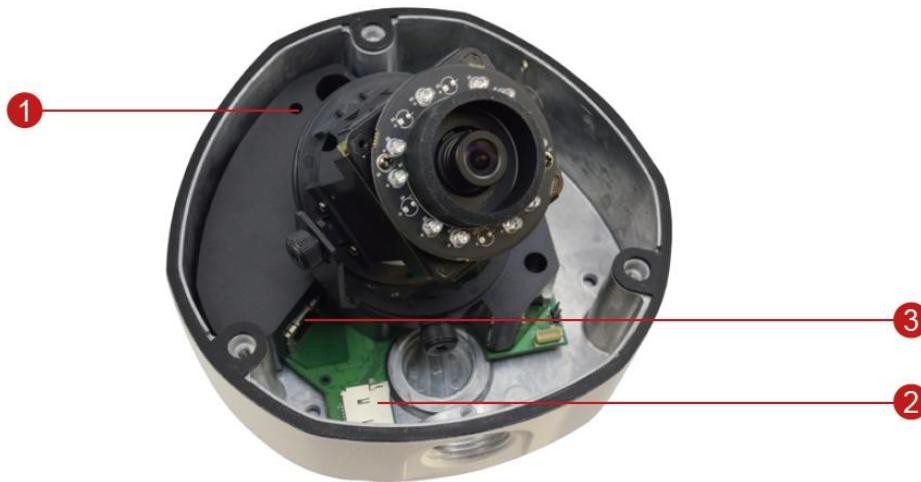

1) Reset Button

The purpose of reset button is to restore the factory default settings of the camera, including the administrator's password.

The reset button can be used for following purposes:

1. The administrator's password has been forgotten and therefore the camera cannot be accessed.
2. In case of IP address, mask, or allow/deny filter related issues, resulting with inability to modify these settings.
3. In case of connectivity issues or abnormal video quality.

How to do the reset properly?

Press and hold the reset button for 5 seconds.

2) Memory Card Slot











Insert a memory card into this slot for local recording. This slot supports microSDHC and microSDXC standards (card not included in the camera package). For more information on using the memory card, please refer to the Firmware User Manual.













3) Ethernet Port

Connects to a network using an Ethernet cable.

Mounting Options

There are several mounting options that you can use to install the camera. Select the most suitable solution for your installation environment.

Mount Types	Accessories
Surface Mount	Suitable when mounting the camera directly walls or ceilings without extra accessories. See Installing the Camera on a Surface on page 13 for mounting instructions.
Flush Mount	Suitable when mounting the camera discretely above dropped ceilings wherein only the dome cover will be visible underneath the ceiling.
	PMAX-1003 
Pendant Mount	Suitable when mounting the camera on hard and high ceilings.
	PMAX-0101 PMAX-0103 (Straight Tube with Bracket)   
	PMAX-0101 PMAX-0102 (Straight Tube)   
	PMAX-0101 PMAX-0102 (Straight Tube)   

Straight Wall Mount	Suitable when mounting the camera on straight walls.		
	PMAX-0308 (L-Type Wall Mount)		
			
Vertical Pole Mount	Suitable when mounting the camera on vertical poles.		
	PMAX-0101	PMAX-0305 (Heavy Duty Wall Mount)	
	  		
Horizontal Pole Mount	Suitable when mounting the camera on horizontal poles.		
	PMAX-0101	PMAX-0305	PMAX-0503
	    		
Corner Mount	Suitable when mounting the camera on a corner wall.		
	PMAX-0101	PMAX-0305	PMAX-0402
	   		

Other Mounting Accessories

Accessories

PMAX-0104 (Extension Tube)



NOTE:

- For more information about the mounting solutions and accessories, please check the *Mounting Accessory Selector* in our website (<http://www.acti.com/mountingselector>).
- The above mounting accessories are not included in the package. Contact your sales agents to purchase.

Installing the Camera on a Surface

This section describes the procedures in installing the camera on a flat surface such as a hard or dropped ceiling and straight or tilted walls.

Step 1: Drill the Holes

1. Using the supplied drill template, mark the screw holes location on the surface, then drill the holes and insert the plastic plugs.
2. Determine how the cables will be routed: **pass through the surface** or **along the surface**.
 - **If the cables will pass through the surface:**
 - a. Mark and drill the conduit hole location on the surface as shown on the drill template.

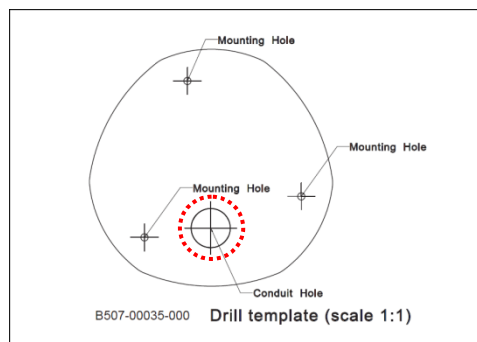

- b. Remove the metal cap covering the bottom conduit hole of the camera, and attach the cap to the side conduit hole to close it. Route the network cable to pass this hole from the surface.



- **If the cables will be routed along the surface**, skip to the next step.

Step 2: Open the Dome Cover

1. Remove the plastic covering the camera.
2. Loosen the three (3) screws securing the dome cover.



3. Carefully lift to open the dome cover and place it on the side of the camera.

NOTE: Do not abruptly lift the dome cover; it is attached to the camera with a spring wire.



Step 3: Prepare for Waterproof Installation

The camera comes with two (2) glands used for waterproof installation:

- **Cable Gland:** For use with an **Exterior-grade Ethernet cable**. Exterior-grade Ethernet cables are already waterproof. See [Waterproof Solution with Naked Cable](#) on page 16.
- **Conduit Gland:** For use with a flexible conduit. This solution is recommended when an exterior-grade Ethernet cable is not available. See [Waterproof Solution with Conduit](#) on page 18.

Determine the type of waterproof solution that is applicable to your installation requirements and prepare the necessary accessories or purchase extra materials.

Cable Gland	Conduit Gland
	
<p>For use with an Exterior-grade Ethernet cable (not included in the package).</p>	<p>For use with a 3/8" flexible conduit (not included in the package).</p>
	<p style="text-align: center;">or</p> 
	<p>For use with 1/2" flexible conduit (not included in the package)</p>  <p>NOTE: The bundled conduit gland may vary. Check the conduit gland that came with your package to determine if 3/8" or 1/2" is the suitable flexible conduit size.</p>

Waterproof Solution with Naked Cable

This section describes the procedures in using the bundled cable gland and an exterior-grade Ethernet cable.

1. Disassemble the cable gland as shown below:



2. Insert the clamping nut into the Ethernet cable.



3. Insert the sealing insert with claw.

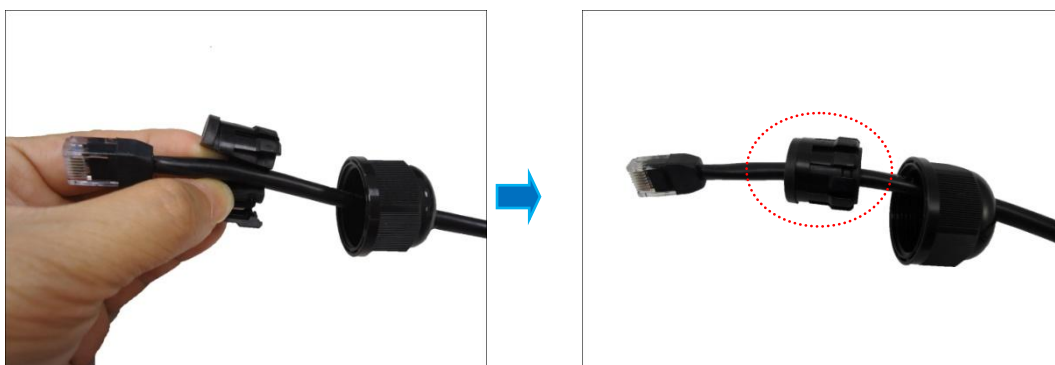

4. Attach the cable gland body to the hole of the camera.



Attach to Camera Side Hole

or



Attach to Camera Bottom Hole

5. ***If the cable will be routed along the surface***, skip this step.
If the cable will pass through the surface, do the following:
 - a. Pull the network cable through the bottom conduit hole.



- b. Insert the sealing insert with claw into the cable gland body and then attach the clamping nut to complete the cable solution.







NOTE: Make sure the clamping nut is tightly attached to the cable gland body and the sealing insert is squeezed tightly.

6. Proceed with [Step 4: Install the Camera to the Surface](#) on page 21.

Waterproof Solution with Conduit

This section describes the procedures to waterproof the cabling connections using the bundled conduit gland and flexible conduit. This is the recommended if an exterior-grade Ethernet cable is not available.

1. Prepare the following materials for waterproof installation:

Conduit Gland (included in the camera package)	
	<div style="background-color: red; color: white; padding: 5px; font-weight: bold; font-size: 1.2em;">or</div> 
For use with 3/8" flexible conduit	For use with 1/2" flexible conduit
Flexible Conduit 3/8" or 1/2" Trade size (not included in the package)	Network Cable CAT 5 or CAT 6 (not included in the package)
	
<p>NOTE: The bundled conduit gland may vary. Check the conduit gland that came with your package to determine if 3/8" or 1/2" is the suitable flexible conduit size.</p>	

2. Disassemble the bundled conduit gland as shown below:

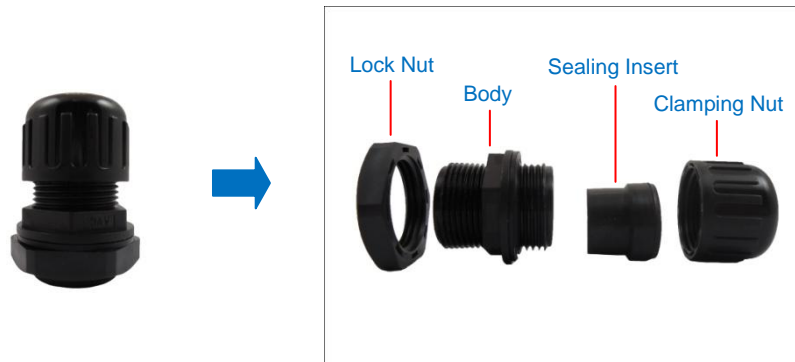

NOTE: In this installation, the conduit gland body can be securely attached to the mount kit; therefore the use of lock nut is not necessary. Please set the lock nut aside.

3. Pull the network cable through the flex conduit.

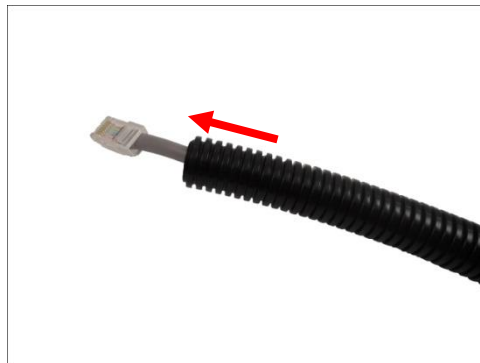

4. Insert the clamping nut through the flex conduit.

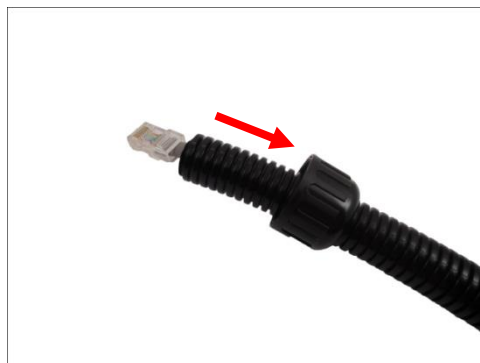

5. Insert the sealing insert and attach it at the end of the flex conduit.

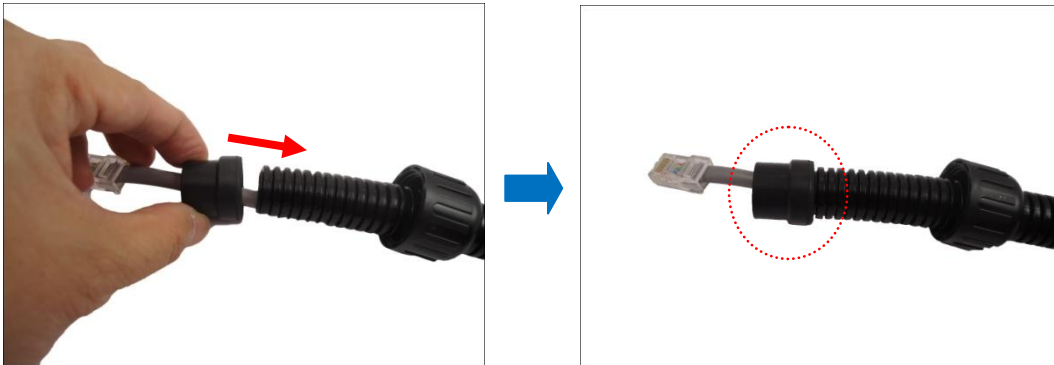

6. Screw the conduit gland body to the conduit hole of the camera.



Attach to Side Conduit Hole

or



Attach to Bottom Conduit Hole

7. ***If the cable will be routed along the surface***, skip this step. ***If the cable will pass through the surface***, do the following:

- a. Pull the network cable through the bottom conduit hole.



- b. Insert the sealing nut into the conduit gland body and then attach the clamping nut to complete the cable solution.

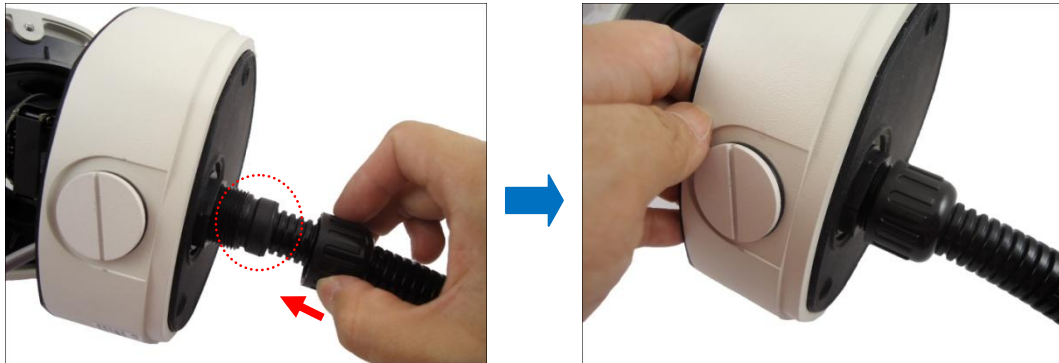

8. Proceed with [Step 4: Install the Camera to the Surface](#) on page 21.

Step 4: Install the Camera to the Surface

1. If necessary, insert a memory card into the memory card slot of the camera.
2. Align the camera screw holes and the conduit hole (if necessary) to the holes on the surface and attach the three (3) supplied screws to secure the camera.



⚠ CAUTION: *When using electric screwdrivers*, be careful not to touch the internal camera components while attaching the screws. Since electric screwdrivers vary in sizes, speed, and force, they may bruise and damage the internal camera components.

DISCLAIMER: ACTi will not be responsible for camera damage caused by improper installations or the misuse of equipment for installation.

Step 5: Connect the Cable

1. **If the cable will be routed along the surface**, pull the network cable through the side conduit hole and attach the clamping nut to the conduit gland body. **If the cable passes through the surface**, skip to step 2.



Using Flex Conduit

or

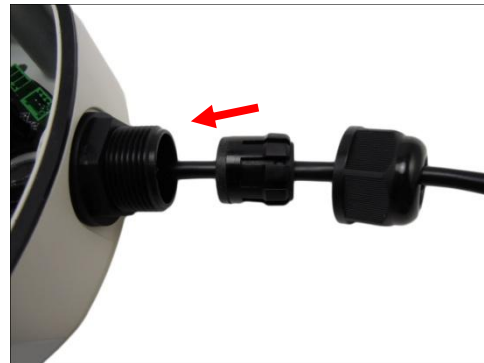

Using Naked Cable

2. Connect the network cable to the Ethernet port of the camera.



3. Connect the other end of the network cable to a Power-over-Ethernet (PoE) switch or injector. Then, connect the PoE switch or injector to a network or PC and a power source. See example connection diagram below.

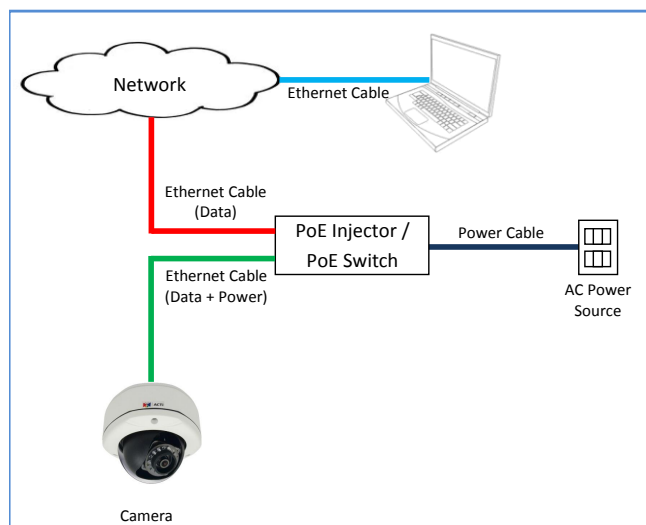

Step 6: Access the Camera Live View

See [Accessing the Camera](#) on page 30 for more information on how to access the Live View of the camera.

Step 7: Adjust the Viewing Angle and Focus

Based on the live view, adjust the viewing angle and orientation of the camera. Adjustments vary per model, for detailed information, please refer to [Focus and Viewing Angle Adjustments](#) on page 24.

Step 8: Close the Dome Cover

1. Align the position of the dome cover shroud to the direction of the lens.



2. Tighten the three (3) screws to attach the dome cover to the camera body.



Other Adjustments and Accessories

Focus and Viewing Angle Adjustments

This section describes the procedures in adjusting the viewing angle, focus, and pan direction of the camera.

D7x / E7x Series

Camera Parts Overview

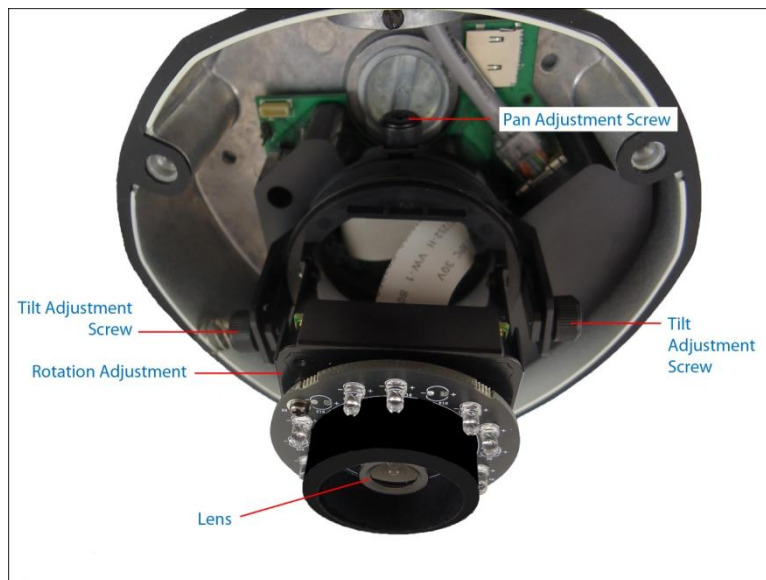

Adjustment Procedures

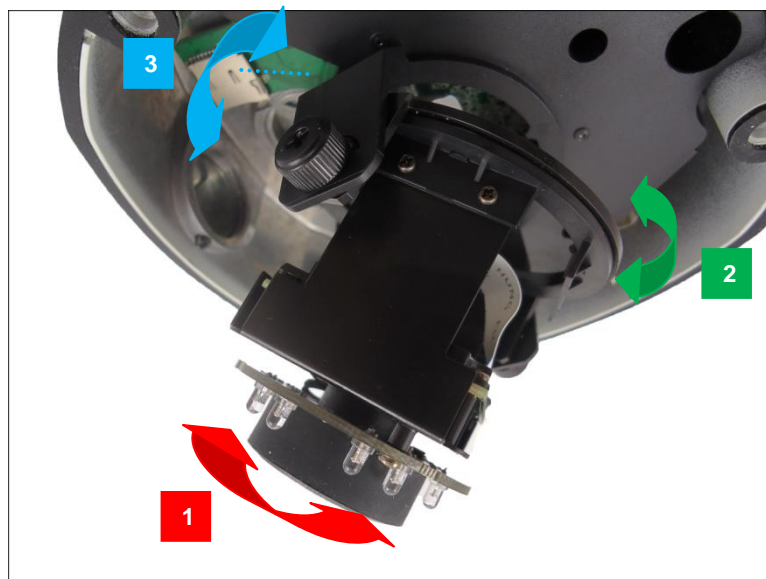

1. Loosen the tilt adjustment screws, adjust the tilt, and then tighten back the screws to fix the tilt position.
2. Move the rotation adjustment to rotate the viewing orientation.
3. Loosen the pan adjustment screw, move the pan direction, and then tighten back the screw to fix the pan position.
4. Attach the bundled lens focus tuner unto the lens and turn left or right to adjust the focus.



D8x / E8x Series

Camera Parts Overview

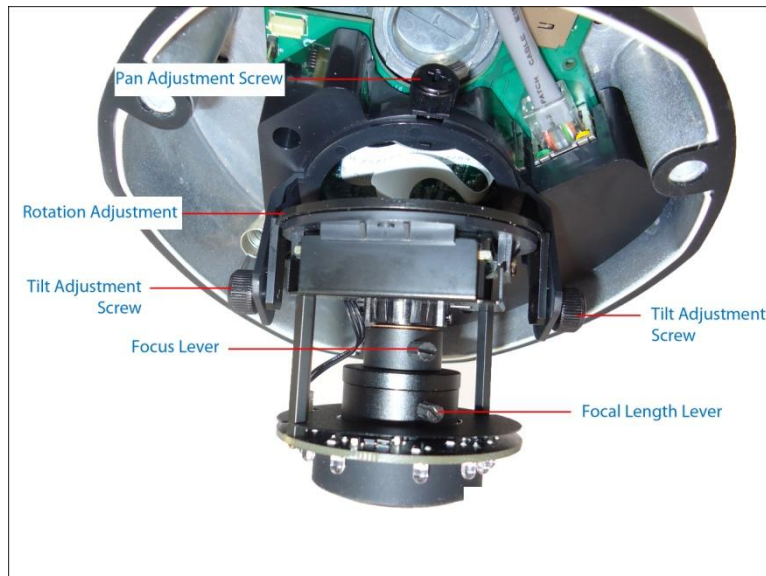

Adjustment Procedures

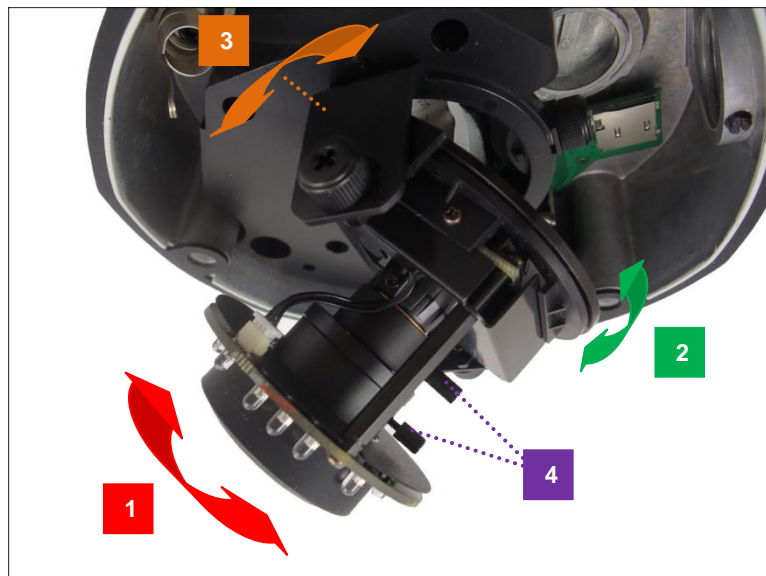

1. Loosen the tilt adjustment screws, adjust the tilt, and then tighten back the screws to fix the tilt position.
2. Move the rotation adjustment to rotate the viewing orientation.
3. Loosen the pan adjustment screw, move the pan direction, and then tighten back the screw to fix the pan position.
4. Move the zoom and focus levers left or right to adjust the focus and the viewing angle.

Replacing the Dome Cover

For more discrete surveillance needs, the bundled dome cover can be replaced with a smoke, vandal proof cover available for purchase. To replace the dome cover, do the following:

1. Loosen the three (3) screws to open the dome cover.



2. Using a screwdriver, remove the screw securing the spring wire to the dome cover.



NOTE: Hold the spring wire as the screw is being removed to avoid the sudden release of the screw and cause it to fly in the air.

3. Remove the three (3) screws to detach the cover bracket.

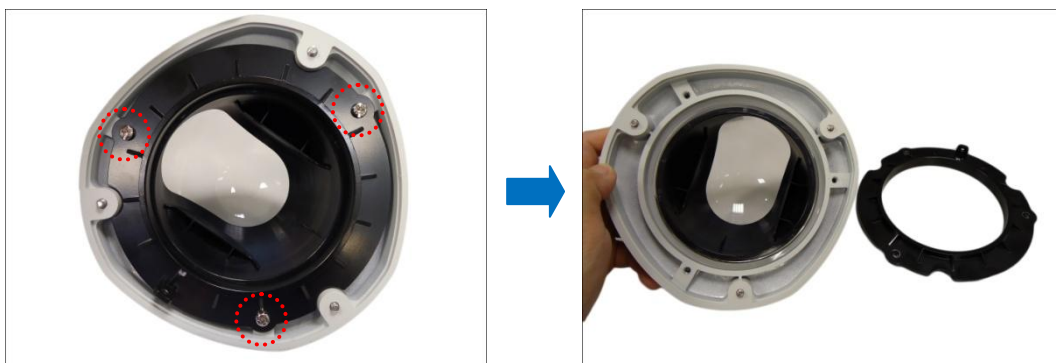

- 4. Remove dome cover from the cover housing.



- 5. Remove the shroud from the dome cover.



- 6. Insert the shroud into the replacement dome cover.



- 7. Insert the replacement dome cover into the cover housing.

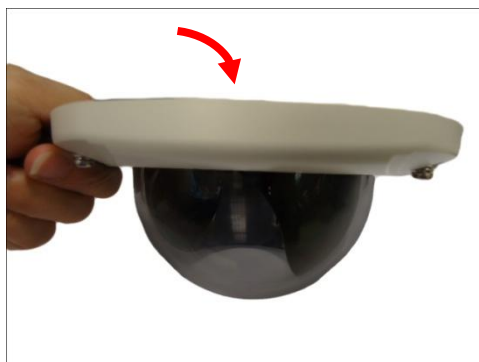

8. Align and attach the three (3) screws to secure the bracket to the cover housing.

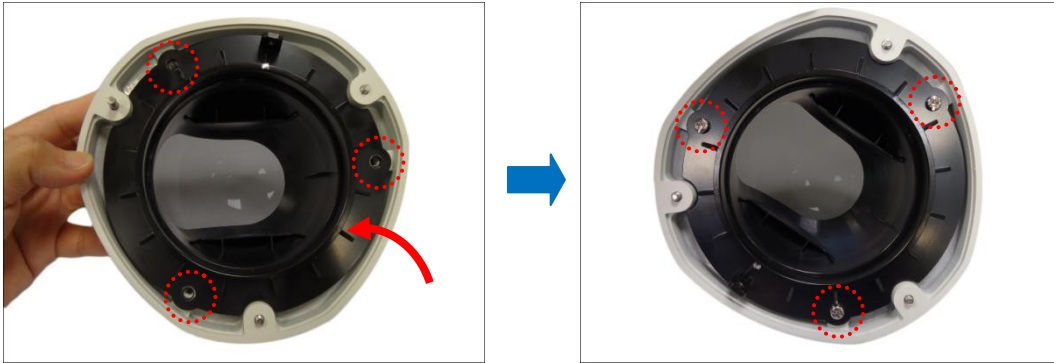

9. Fit the screw into the spring wire that is attached to the camera.



10. Attach the screw to the dome cover using a screwdriver. Final installation should look like the illustration below.

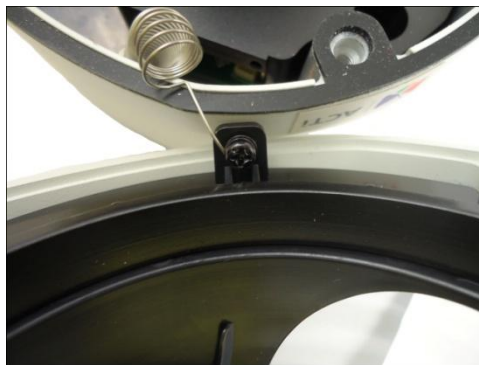

Accessing the Camera

Configure the IP Addresses

In order to be able to communicate with the camera from your PC, both the camera and the PC have to be within the same network segment. In most cases, it means that they both should have very similar IP addresses, where only the last number of the IP address is different from each other. There are 2 different approaches to IP Address management in Local Area Networks – by DHCP Server or Manually.

Using DHCP server to assign IP addresses:

If you have connected the computer and the camera into the network that has a DHCP server running, then you do not need to configure the IP addresses at all – both the camera and the PC would request a unique IP address from DHCP server automatically. In such case, the camera will immediately be ready for the access from the PC. The user, however, might not know the IP address of the camera yet. It is necessary to know the IP address of the camera in order to be able to access it by using a Web browser.

The quickest way to discover the cameras in the network is to use the simplest network search, built in the Windows system – just by pressing the “Network” icon, all the cameras of the local area network will be discovered by Windows thanks to the UPnP function support of our cameras.

In the example below, we successfully found the camera model that had just connected to the network.

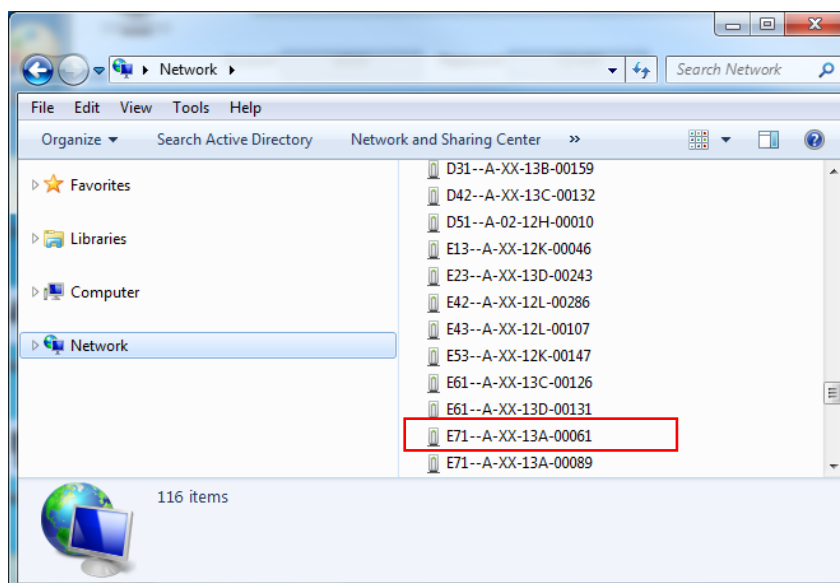

By double-clicking on the camera model name it is possible to automatically launch the default browser of the PC with the IP address of the target camera filled in the address bar of the browser already.

If you work with our cameras regularly, then **there is even a better way to discover the cameras in the network** – by using **IP Utility**. The IP Utility is a light software tool that can not only discover the cameras, but also list lots of valuable information, such as IP and MAC addresses, serial numbers, firmware versions, etc, and allows quick configuration of multiple devices at the same time.

The IP Utility can be downloaded for free from http://www.acti.com/IP_Utility

With just one click, you can launch the IP Utility and there will be an instant report as follows:

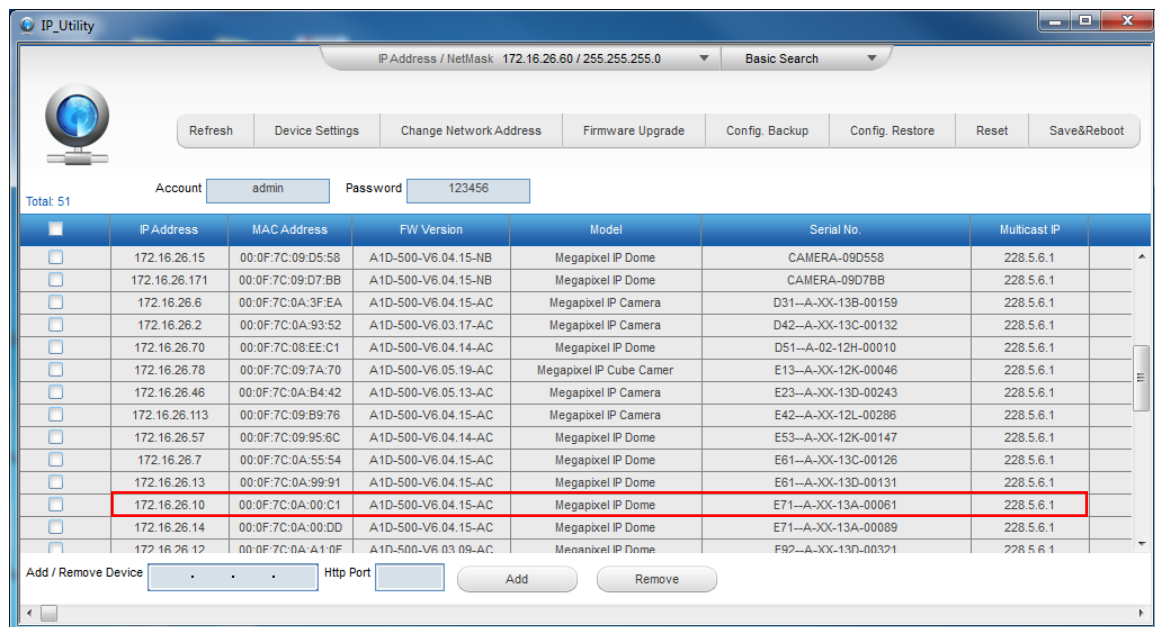

You can quickly notice the camera model in the list. Click on the IP address to automatically launch the default browser of the PC with the IP address of the target camera filled in the address bar of the browser already.

Use the default IP address of a camera:

If there is no DHCP server in the given network, the user may have to assign the IP addresses to both PC and camera manually to make sure they are in the same network segment.

When the camera is plugged into network and it does not detect any DHCP services, it will automatically assign itself a default IP:

192.168.0.100

Whereas the default port number would be **80**. In order to access that camera, the IP address of the PC has to be configured to match the network segment of the camera.

Manually adjust the IP address of the PC:

In the following example, based on Windows 7, we will configure the IP address to **192.168.0.99** and set Subnet Mask to **255.255.255.0** by using the steps below:

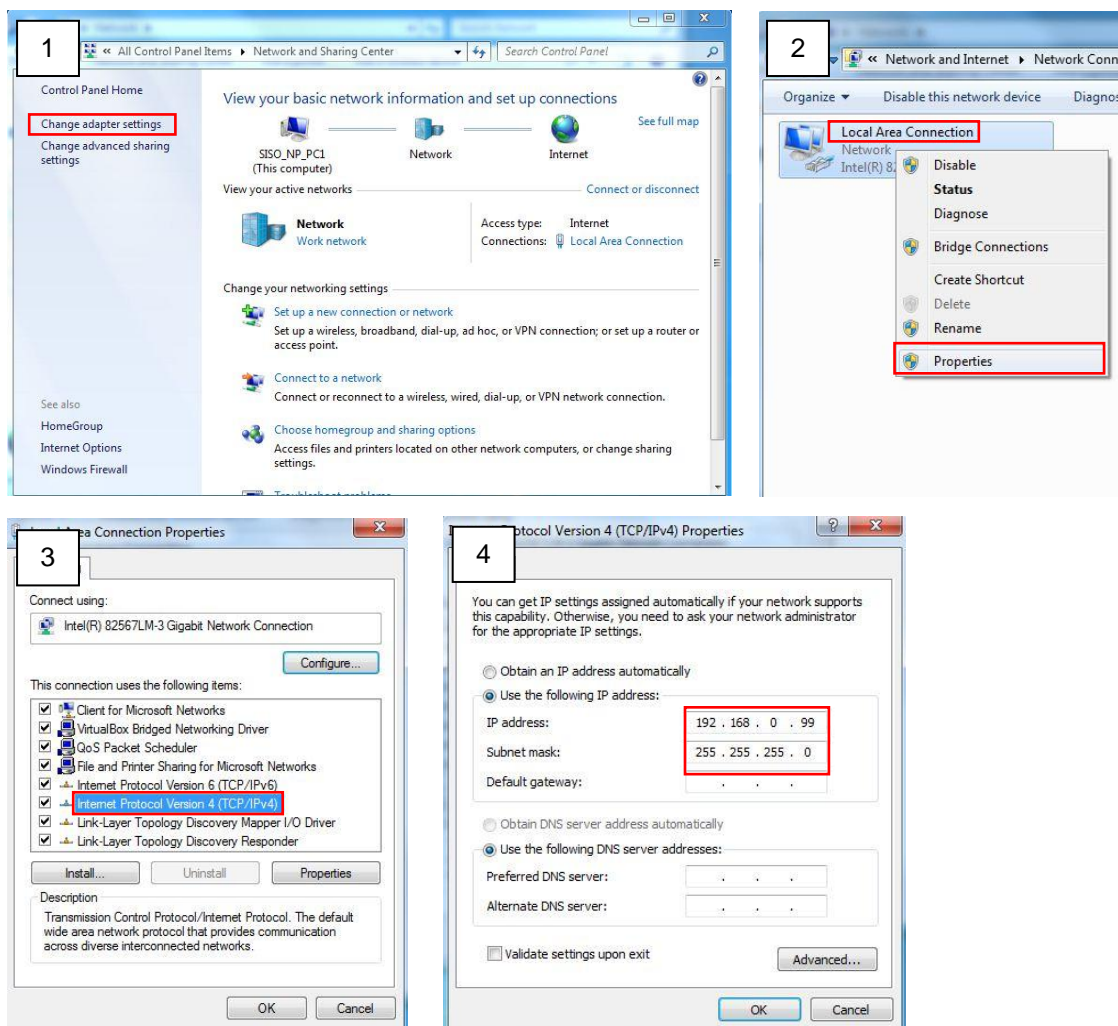

Manually adjust the IP addresses of multiple cameras:

If there are more than 1 camera to be used in the same local area network and there is no DHCP server to assign unique IP addresses to each of them, all of the cameras would then have the initial IP address of **192.168.0.100**, which is not a proper situation for network devices – all the IP addresses have to be different from each other. The easiest way to assign cameras the IP addresses is by using **IP Utility**:

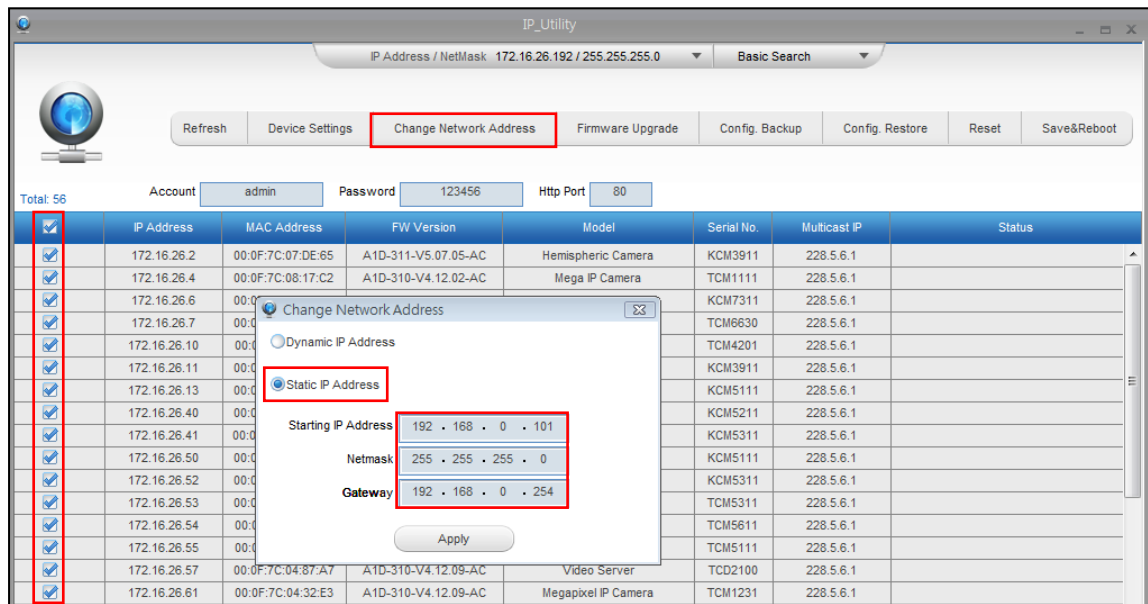

With the procedure shown above, all the cameras will have unique IP addresses, starting from 192.168.0.101. In case there are 20 cameras selected, the last one of the cameras would have the IP 192.168.0.120.

Later, by pressing the “Refresh” button of the IP Utility, you will be able to see the list of cameras with their new IP addresses.



Please note that it is also possible to change the IP addresses manually by using the Web browser. In such case, please plug in only one camera at a time, and change its IP address by using the Web browser before plugging in the next one. This way, the Web browser will not be confused about two devices having the same IP address at the same time.

Access the Camera

Now that the camera and the PC are both having their unique IP addresses and are under the same network segment, it is possible to use the Web browser of the PC to access the camera.

You can use **any of the browsers** to access the camera, however, the full functionality is provided only for **Microsoft Internet Explorer**.

The browser functionality comparison:

Functionality	Internet Explorer	Other browsers
Live Video	Yes	Yes*
Live Video Area Resizable	Yes	No
PTZ Control	Yes	Yes
Capture the snapshot	Yes	Yes
Video overlay based configuration (Motion Detection regions, Privacy Mask regions)	Yes	No
All the other configurations	Yes	Yes

* When using non-Internet Explorer browsers, free third-party software plug-ins must be installed to the PC first to be able to get the live video feed from the camera. Check the firmware version of the camera to determine which plug-in is necessary:

Firmware Version	Required Plug-In
A1D-500-V6.04.xx-AC or older	Basic VLC Media Player (http://www.videolan.org)
A1D-500-V6.05.xx-AC or newer	QuickTime (http://www.apple.com/quicktime/download/)

The camera firmware version can be found on the **FW Version** column of the IP utility or access the **Setup** page of the Web Configurator (see page 36).

***Disclaimer Notice:** The camera manufacturer does not guarantee the compatibility of its cameras with VLC player or QuickTime – since these are third party softwares. The third party has the right to modify their utility any time which might affect the compatibility. In such cases, please use Internet Explorer browser instead.*

When using Internet Explorer browser, the ActiveX control for video stream management will be downloaded from the camera directly – the user just has to accept the use of such control when prompted so. No other third party utilities are required to be installed in such case.

The following examples in this manual are based on Internet Explorer browser in order to cover all functions of the camera.

Assuming that the camera's IP address is **192.168.0.100**, you can access it by opening the Web browser and typing the following address into Web browser's address bar:

http://192.168.0.100

Upon successful connection to the camera, the user interface called **Web Configurator** would appear together with the login page. The HTTP port number was not added behind the IP address since the default HTTP port of the camera is 80, which can be omitted from the address for convenience.

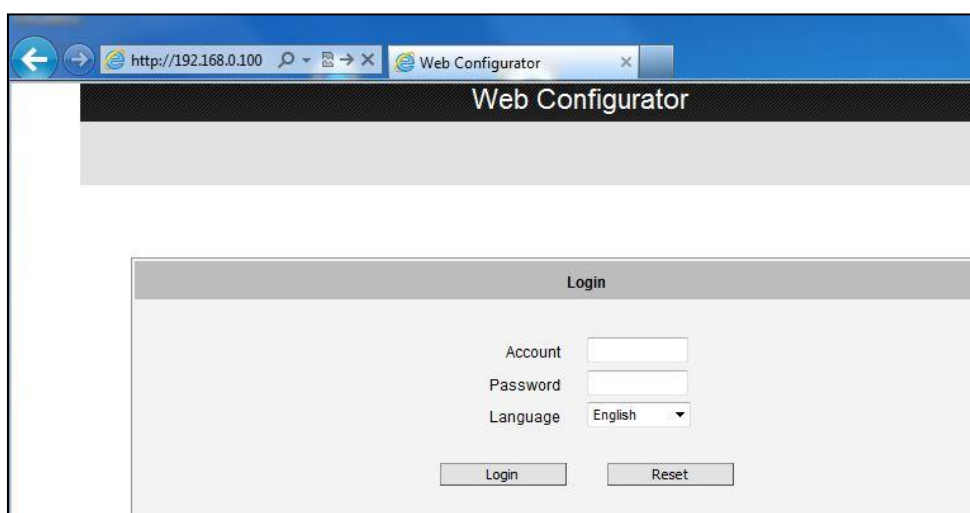

Before logging in, you need to know the factory default Account and Password of the camera.

Account: **Admin**

Password: **123456**

To check the firmware version through the Web Configurator, access the **Setup** page and click **System > System Info**.

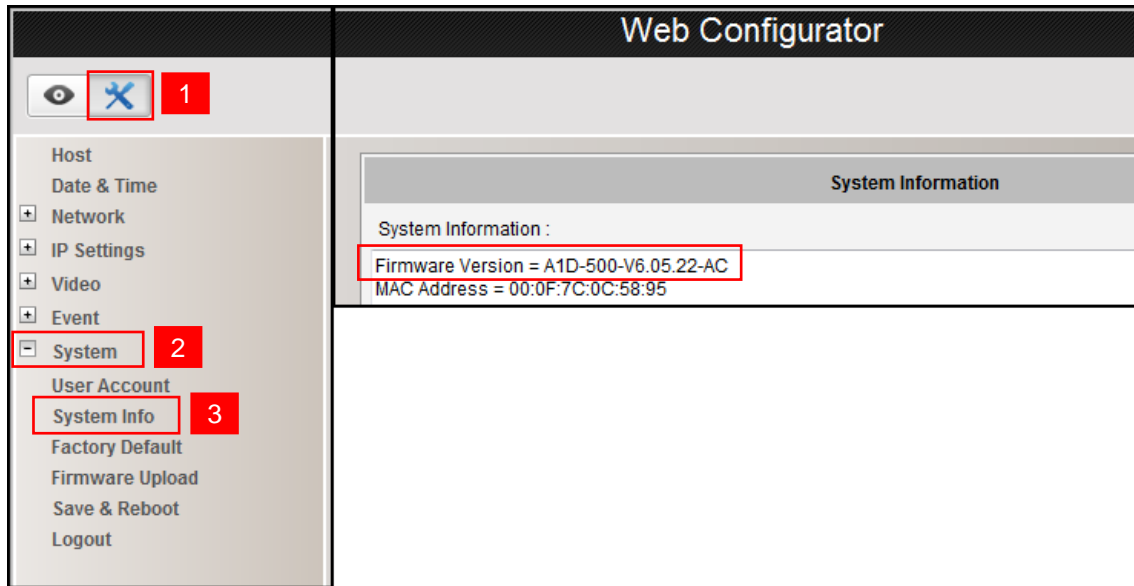

For further operations, please refer to the **Firmware User Manual**.