

Battery Station

Operating Instructions



5-048-993-11(1)

LBN-H1

Before using this product

When using a portable power supply, inverter or generator, ensure that is capable of supplying more than 1 000 Watts.

Included items

Power cord (1)



Accessory socket cap (3)



Operating Instructions (1)
Warranty (1)

Using the accessory socket cap

The accessory socket cap can be also used as a stopper to prevent the lid from accidentally shutting due to wind or other factors while using this product.

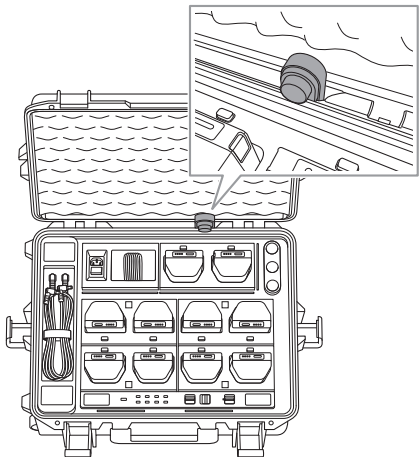

Parts and Controls

Outside of the product

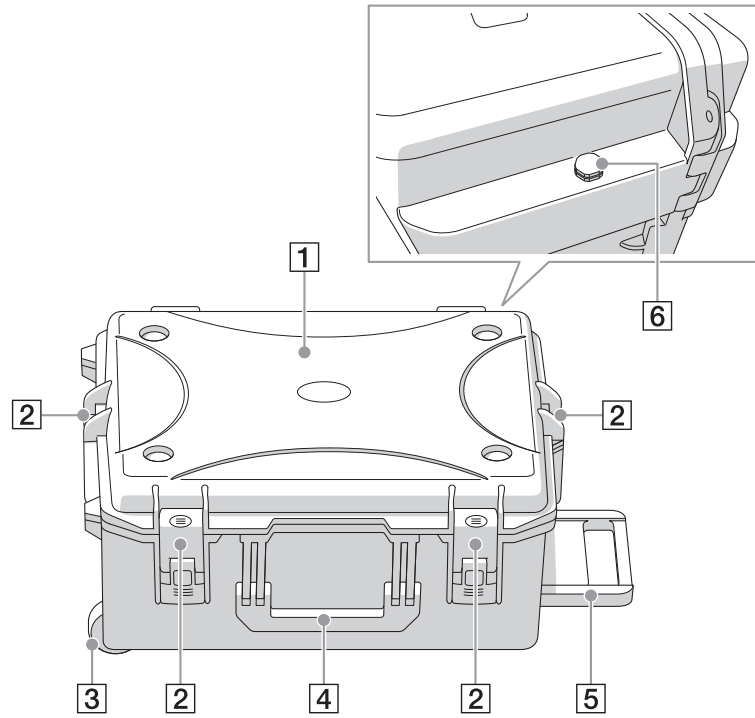

- 1 Lid
 - 2 Lid lock
 - 3 Wheels
 - 4 Handle
 - 5 Retractable handle
 - 6 Pressure valve
- The air pressure inside the Battery Station is adjusted automatically. Do not touch the pressure valve.

Inside of the product

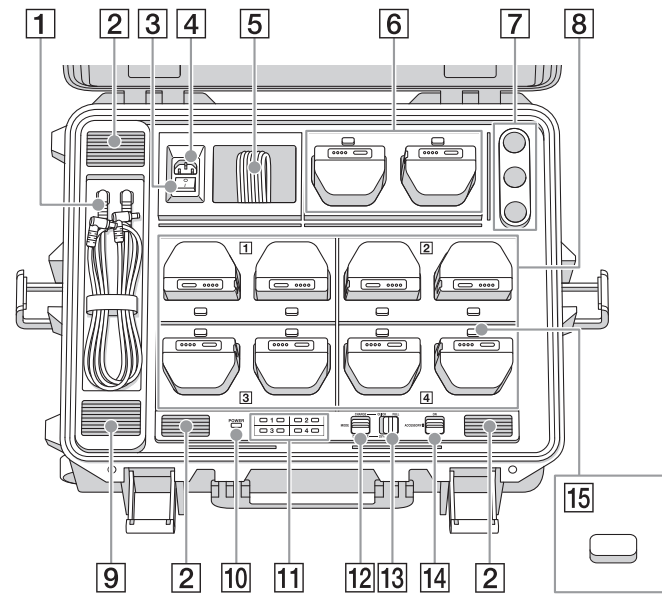

- 1 Dedicated remote controller charging cables
- 2 Air vent
- 3 Power switch
- 4 Power port
- 5 Storage pocket
- 6 Battery storage slot
- 7 Accessory sockets
- 8 Battery slot (Battery charging/discharging slot)
- 9 Air outlet
- 10 Power LED

11 Battery status LEDs

You can check the charge/discharge status of the battery packs inserted in the battery slots.

LED color	LED indication	Status of the battery pack
—	Off	Battery pack is not inserted.
Green	Lit up	Charging has completed.
Orange	Lit up	Charging.
Orange	Blinking slowly	Waiting for charging to start. Charging will start when charging of the battery pack inserted in the battery slot facing up/down has completed.
Orange	Blinking fast twice	Due to the high temperature of the battery pack, it cannot be charged.
Orange	Blinking fast three times	Due to the low temperature of the battery pack, it cannot be charged.
Blue	Lit up	Discharging has completed.
Purple	Lit up	Discharging.
Purple	Blinking fast twice repeatedly	Due to the high temperature of the battery pack, it cannot be discharged.
Red	Blinking slowly	Due to some problem with the battery pack, it cannot be charged/discharged.

12 MODE switch

Switches between charging (CHARGE)/discharging (DISCHARGE) of the battery packs.

13 OPTION switch

Sets the charging/discharging level.

- For charging (when the MODE switch is set to CHARGE): Selects the charging level (FULL or QUICK).
- For discharging (when the MODE switch is set to DISCHARGE): Selects the discharging level (50% or 25%).

14 ACCESSORY switch

Switches the power supply from the dedicated remote controller charging cables and the accessory sockets on and off.

15 Battery release button

Remove the battery pack while pressing the battery release button.

Charging battery packs

1 Slide the MODE switch to CHARGE.

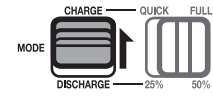

2 Slide the OPTION switch to FULL or QUICK to select the charging level.

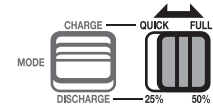

- FULL (Full charge): Charges until the battery level reaches 100%.
- QUICK (Practical charging): Charges until the battery level reaches 90%. The charging time is shorter than FULL.

3 Connect the power cord to the power port and wall outlet, and then turn on the power switch.

4 Insert the battery packs to charge into the battery slots 1 to 4 in order.

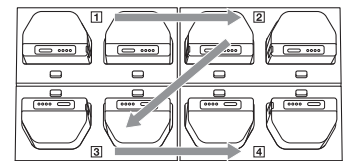

Insert firmly until the battery packs click and lock into place.

5 Confirm that the battery status LED lights up in orange.

The battery status LED lights up in orange during charging. The battery level LEDs on the battery pack indicate the battery level.

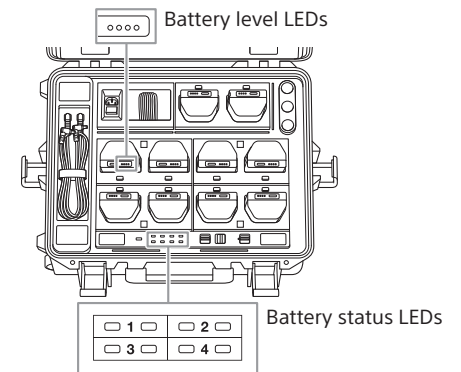

6 Check the charging status of the battery pack.

While charging, you can check the charge level with the battery level LEDs on the battery pack.

Battery level

- 0%–25%: The LED on the far left blinks.
- 26%–50%: The 2nd LED from the left blinks.
- 51%–75%: The 3rd LED from the left blinks.
- 76%–99%: The LED on the far right blinks.
- Charging complete: All LEDs are off.

7 When charging has completed, remove the battery pack while pressing the battery release button.

About the battery charging mechanism

- Battery packs in the battery slots facing up/down cannot be charged at the same time. Charging starts from the battery slot into which the battery pack was inserted first. The other will be in a standby state, and will start charging when the battery pack that started charging first has completed charging.

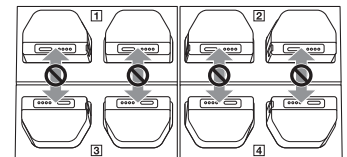

- Up to 4 battery packs can be charged at the same time.
- If you turn on the battery station with the battery packs already inserted into the battery slots, charging starts from battery slots 1 and 2.
- If the temperature of the battery pack is too high, such as immediately after flight, charging will not start due to the protection function. The battery status LED will repeat blinking fast twice in orange and the cooling fan will automatically start. When the battery pack cools down to a chargeable temperature, charging will start automatically.

Continued on the reverse side →

Charging remote controllers

Use the dedicated remote controller charging cables (for RCR-VH1) to charge up to 2 remote controllers at the same time.

1 Connect the power cord to the power port and wall outlet, and then turn on the power switch.

2 Slide the ACCESSORY switch to ON.

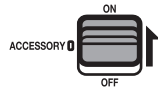

3 Connect the dedicated remote controller charging cable to the power port of the remote controller.

Charging starts. You can check the battery level by pressing the $\text{\textcircled{P}}$ (Power) button on the remote controller.

Charging peripheral devices

You can charge devices such as a mobile device and camera by connecting commercially available chargers for cigarette lighter sockets (12 V) to the accessory sockets.

1 Connect the power cord to the power port and wall outlet, and then turn on the power switch.

2 Slide the ACCESSORY switch to ON.

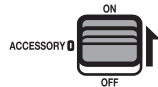

3 Connect the device that you want to charge to the accessory socket using a charger for cigarette lighter sockets.

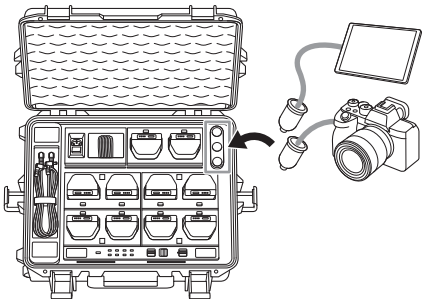

Charging starts.

Note

- The accessory socket does not support outputs of 50 W or more.

Discharging battery packs

The battery station can discharge battery packs whether the power is on or off. If you discharge with the power of this product on, you can discharge to a level closer to the set value (25%, 50%) than when the power is off.

1 To discharge with the power on, connect the power cord to the power port and wall outlet, and then turn on the power switch.

2 Slide the MODE switch to DISCHARGE.

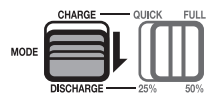

3 Slide the OPTION switch to 25% or 50% to select the discharging level.

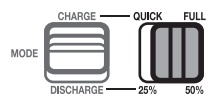

- 50%: Discharges until the remaining battery level is 50% or less. This setting is suitable for storing the battery packs for a long period of time.
- 25%: Discharges until the remaining battery level is 25% or less. This setting is suitable for transportation by air.

4 Insert the battery packs to discharge into the battery slots.

All 8 battery slots can discharge simultaneously. The battery status LED blinks slowly in blue during discharging. When discharging has completed, the LED lights up in purple. The battery level LEDs will not blink when discharging.

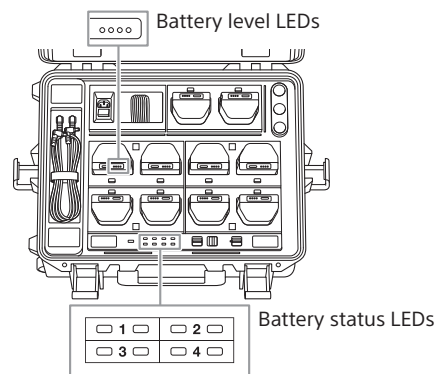

Note

- If the battery level of the battery pack is the value set in step 3 or less, discharging will not be performed.

Safety Information

WARNING

- A damaged power cord may cause a fire or electric shock. Observe the following cautions to avoid damaging the power cord.
 - Do not pinch the power cord between the unit and a table, wall, or other object.
 - Do not modify or damage the power cord.
 - Do not place heavy objects on the power cord or pull on the power cord.
 - Keep the power cord away from heaters and other heat sources.
 - When you disconnect the power cord, always hold it by the plug.
- Disconnect the power cord before moving the product. Otherwise, the power cord may become damaged, resulting in a fire or electric shock. Also, take care not to drop the product.
- For safety reasons, if the product is not to be used for long periods, unplug it from the wall outlet.
- Do not place or store the product in a location exposed to direct sunlight or close to a heater.
- Do not use or store the product where there is excessive oily smoke, steam, moisture, or dust. This may cause a fire or electric shock. Use or storage in an environment other than the operating conditions described in this manual may cause a fire or electric shock.
- Do not let water or foreign objects get inside the unit. This may cause a fire or electric shock. If water or foreign objects get inside the unit, remove the battery pack from the unit immediately, and disconnect the power cord.
- Do not disassemble the product. Disassembly or modification of the unit and power cord may cause a fire or electric shock.
- Do not charge the battery pack if there is a possibility of lightning strike. A lightning strike may cause an electric shock. If lightning is likely, unplug the product from the wall outlet to prevent a fire, electric shock, or product failure. Also, if you hear thunder, refrain from touching the product.
- Use only the battery pack exclusively for this unit. Use of a different battery pack may cause a fire or electric shock.
- Do not operate the product or touch the power cord with wet hands. This may cause an electric shock.
- Use the included power cord. The included power cord is for use exclusively with this unit, and cannot be used with other products. Also, use only the included power cord with the unit. Use of a different power cord may generate heat, causing a fire or electric shock.
- Do not use the unit while it or the AC adapter is covered by a cloth or other object.
- Unplug the product from the wall outlet before cleaning it with a dry cloth.
- Firmly connect the connectors.
 - Do not insert metal objects into the connector ports. This may short-circuit the pins and cause a fire.
 - Insert the connectors straight into the ports. When inserting the connectors, do not apply excessive force to the ports.
- This product is designed for use only in the U.S.A.
 - Use with 120 V AC power.
 - Use with other voltages, such as in other countries or regions, may cause a fire or electric shock. Note that the power cord may support different input voltages. Be sure to check the descriptions of the power cord.

CAUTION

- Do not subject the product to strong impacts. If you apply excessive force to the product, such as by putting a heavy object on top of it, dropping it, or stepping on it, this may cause an injury or product failure. Also, do not pull the handle forcibly, as the handle may come loose during transportation and cause injury.
- This equipment is not suitable for use in locations where children are likely to be present.

- Hot air is exhausted from the air outlet. Keep objects, hands, etc. away from the air outlet. Not doing so may cause an accident or injury.
- Keep your face away from the air outlet. The wind from the air outlet may blow foreign matter and cause an accident or injury, such as getting it in your eyes.
- Do not place this product in an unstable place such as on a chair or bench. Doing so may cause an accident or injury due to a fall.
- Be careful not to drop this product by catching it on the power cord. Doing so may cause an accident or injury.
- When switching the switches, be careful not to get your fingers caught in the gaps around the switches.

Compliance Information

Supplier's Declaration of Conformity

Trade Name: SONY

Model: LBN-H1

Responsible Party: Sony Electronics Inc.

Address: 16535 Via Esprillo, San Diego, CA 92127

U.S.A.

Telephone Number: 858-942-2230

This device complies with Part 15 of the FCC Rules. Operation is subject to the following two conditions: (1) This device may not cause harmful interference, and (2) this device must accept any interference received, including interference that may cause undesired operation.

Note:

This equipment has been tested and found to comply with the limits for a Class A digital device, pursuant to part 15 of the FCC Rules. These limits are designed to provide reasonable protection against harmful interference when the equipment is operated in a commercial environment. This equipment generates, uses, and can radiate radio frequency energy and, if not installed and used in accordance with the instruction manual, may cause harmful interference to radio communications. Operation of this equipment in a residential area is likely to cause harmful interference in which case the user will be required to correct the interference at his own expense.

You are cautioned that any changes or modifications not expressly approved in this manual could void your authority to operate this equipment.

This device relies upon the grounding conductor for safety. The plug of the power cord shall be connected to a socket-outlet with earthing/grounding connection.

Notes on Use

- This product is designed for use only in the U.S.A. Operation is not guaranteed when used in other countries or regions.
- Do not connect the power cord to an electronic transformer (travel converter). This may cause heat generation or product failure.
- It may take about 20 seconds before charging starts.
- If the temperature of the battery pack is high during charging, it may not be possible to resume charging immediately if charging has been interrupted by removing the battery pack from the battery slot and inserting it again or turning the power off and on again. In that case, wait until the battery pack cools down to a chargeable temperature. Charging will resume automatically.
- Do not block the air vent or air outlet.
- Avoid using this product in direct sunlight or in high-temperature environments.
- Use with the lid fully open.
- Condensation may occur on the surface or inside of the product when it is suddenly brought from a cold place to a warm place. Continuing to use the product as it may cause a malfunction. If condensation occurs, leave it until it dries without turning on the power.
- When using this product, place it horizontally on a flat surface.

Caution when carrying the unit

- When carrying the unit, take care not to drop it. If the unit is dropped, this may cause damage to the unit or injuries.
- When storing or transporting batteries in this product, be careful not to exceed the battery storage temperature range (-20 °C (-4 °F) to 45 °C (113 °F)).

Specifications

Model

LBN-H1

Dimensions

Approx. 553 mm (21 7/8 in.) × 423 mm (16 3/4 in.) × 258 mm (10 1/4 in.) (H/W/D, including projecting parts)

Mass

Approx. 15.2 kg (33 lb 8.2 oz) (Not including battery pack, power cord, etc.)

Supported battery pack

LBP-HS1, LBP-HM1

Battery slot for charging/discharging

2 slots × 4 groups

Output rating for charging

Up to 42 V, 4 A

Charging time

(supports 4-slot simultaneous charge)

Battery pack LBP-HS1

- FULL (from 0% to 100%): Approx. 55 minutes each
- FULL (from 20% to 100%): Approx. 50 minutes each
- QUICK (from 20% to 90%): Approx. 30 minutes each

Battery pack LBP-HM1

- FULL (from 0% to 100%): Approx. 75 minutes each
- FULL (from 20% to 100%): Approx. 65 minutes each
- QUICK (from 20% to 90%): Approx. 40 minutes each

Interval between the completion of charging the first battery pack and the start of charging the second one

Approx. 30 seconds

Discharging time

(supports 8-slot simultaneous discharge)

Battery pack LBP-HS1

- 50% (from 100% to 50%): Approx. 17 hours each
- 25% (from 100% to 25%): Approx. 27 hours each

Battery pack LBP-HM1

- 50% (from 100% to 50%): Approx. 26 hours each
- 25% (from 100% to 25%): Approx. 40 hours each

Maximum power consumption

1 000 W

Operating Temperature

0 °C (32 °F) — 40 °C (104 °F)

Storage Temperature

-20 °C (-4 °F) — 60 °C (140 °F) (without Battery Pack)

-20 °C (-4 °F) — 45 °C (113 °F) (with Battery Pack)

Accessory socket output voltage

12.7 V per port, up to 4.5 A
5 A total for 3 ports

Remote controller dedicated charging output

14 V per port, up to 2.6 A