

GIGABYTE™

P27

USER'S MANUAL

使 用 手 冊

● English

V1.1



* Images Used for Reference Only



Congratulations on your purchase of the GIGABYTE Notebook P27!

This Manual will help you to get started with setting up your notebook. For more detailed information, please visit our website at <http://www.gigabyte.com>. All specifications are subject to the manufacturer's configuration at the time of shipping and may change without prior notice, written or otherwise.

Using GIGABYTE Notebook for the First Time

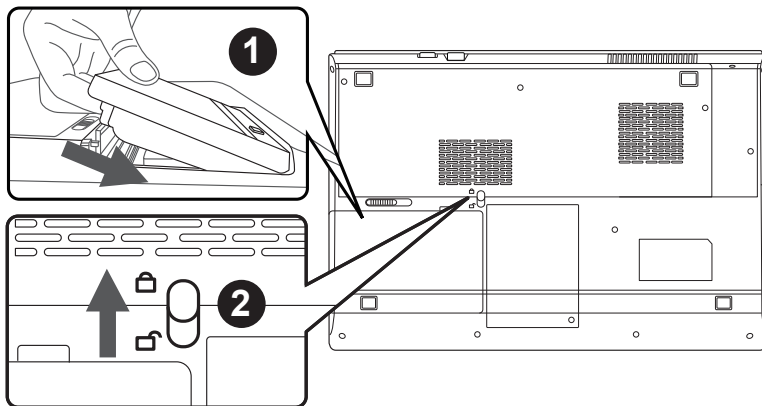

To install the battery please follow these steps:

- 1 Insert the battery pack into the compartment.
- 2 Remember to slide the switch to the "Lock" position.

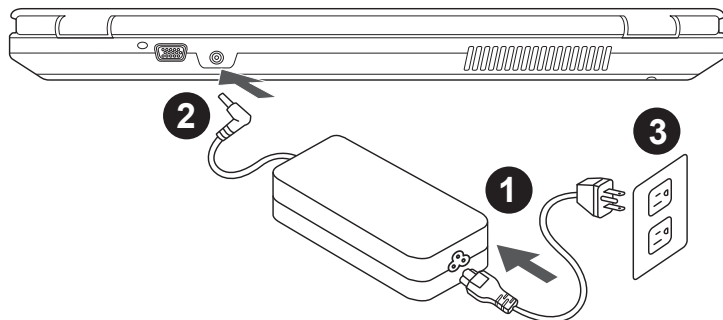

- 1 Connect the the power cord to the AC adapter.
- 2 Connect the AC adapter to the DC-in jack on the back side of the notebook.
- 3 Connect the power cord to the power outlet.

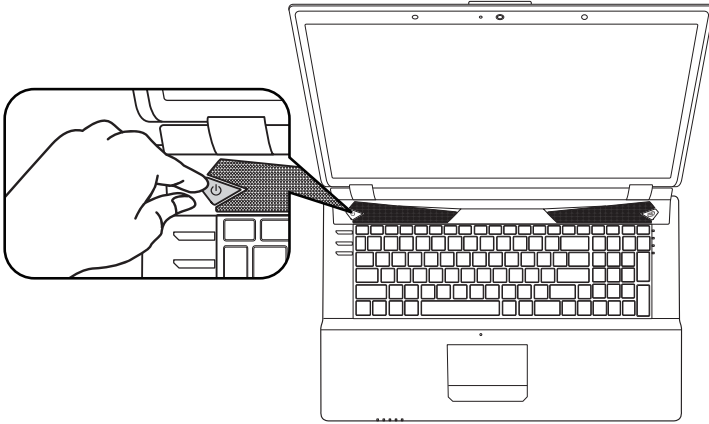

Switching on the Power:

After you turn on the P27 for the very first time, do not turn it off until the operating system has been configured. Please note that the volume for the audio will not function until Windows® Setup has completed.

Booting Up the P27 for the First Time:

Depending on your configuration, the Microsoft® Windows® Boot Screen will be the first screen that you will see as the notebook starts up. Follow the on screen prompts and instructions and enter your personal information to complete the setup of the Windows® Operating System.

Top & Front View

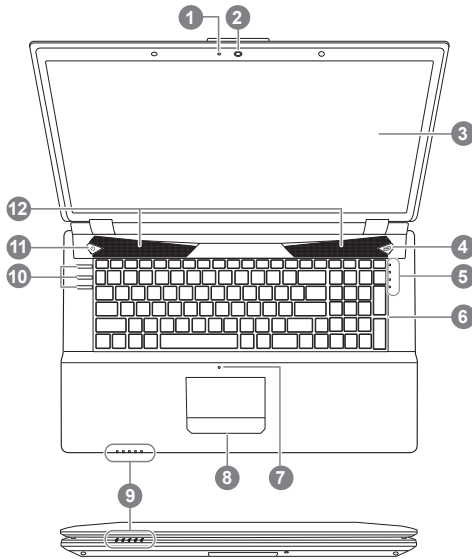

- 1 Webcam Status LED Indicator
- 2 Webcam
- 3 Display
- 4 Turbo Boost Technology Button ①
- 5 LED Indicators ②
- 6 Keyboard
- 7 Microphone
- 8 Touchpad
- 9 LED Indicators ③
- 10 Hotkey Button ④
- 11 Power Button ⑤
- 12 Speakers

* Refer more information on page 5

Left View

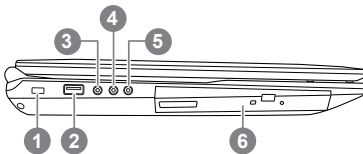

- 1 Kensington Lock Slot
- 2 USB 2.0 Port
- 3 S/PDIF-Out Jack
- 4 Microphone Jack
- 5 Headphone Jack
- 6 Optical Disc Drive

Right View

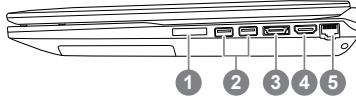

- 1 Multi-in-1 Card Reader
- 2 USB 3.0 Port x 2
- 3 Combined eSATA/
USB 3.0 Port
- 4 HDMI Port
- 5 Ethernet Port



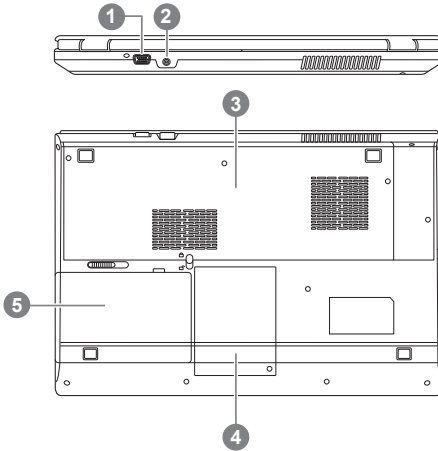









Rear & Bottom View



- 1 D-sub (VGA) Port
- 2 DC-in Jack
- 3 Component Bay Cover
- 4 HDD Bay
- 5 Battery

Hot Key Buttons & LED Indicators













The LED indicators on the computer display helpful information about the current status of the computer.

Button & Indicator	Icon	Light Color	Description
Turbo boost Button ❶		Green	Intel Turbo boost OFF
		Orange	Intel Turbo boost ON
LED Indicators ❷		Orange	NVIDIA Discrete GPU (dGPU) Activated
		Green	Intel Integrated GPU (iGPU) Activated
		White	Hard Disk Activity
		Green	The WLAN & Bluetooth Modules are OFF
LED Indicators ❸		Orange	AC/DC Power is Plugged In
		Green	The Computer is On
		Blinking Green	The Computer is in Sleep Mode
		Orange	The Battery is Charging
		Green	The Battery is Fully Charged
		Blinking Green	The Battery Has Reached Critically Low Power Status
			Green
	Green		Caps Lock is Activated
	Green		Scroll Lock is Activated
Hotkey Button ❹		N/A	Webcam ON/OFF
		N/A	Mute Toggle ON/OFF
		N/A	WLAN ON/OFF
Power Button ❺		White	The Computer is Powered On

Hotkeys

The computer employs hotkeys or key combinations to access most of the computer's controls like screen brightness and volume output.

To activate hotkeys, press and hold the <Fn> key before pressing the other key in the hotkey combination.

Hotkey	Function	Description
 Fn + ~	Playback	Media Playback control.
 Fn + F1	Touchpad Toggle	Turn the internal touchpad ON/OFF
 Fn + F2	LCD Toggle	Turn LCD OFF (Press a key to or use TouchPad to turn on)
 Fn + F3	Speaker Toggle	Turn the speaker ON/OFF
 Fn + F4	Sleep Toggle	Put the computer in Sleep mode
 Fn + F5	Volume Down	Decrease the sound Volume
 Fn + F6	Volume Up	Increase the sound Volume
 Fn + F7	Display Toggle	Switch display output between the display screen , external monitor (if connected) and both.
 Fn + F8	Brightness Down	Decrease the screen brightness
 Fn + F9	Brightness Up	Increase the screen brightness
 Fn + F10	Webcam	Turn the internal webcam ON/OFF
 Fn + F11	Airplane Mode Toggle	Turn the Airplane Mode ON/OFF
 Fn + F12	Keyboard Backlight Toggle	Turn the keyboard backlight ON/OFF

System Setup

Pressing the hot keys to adjust BIOS setup, system recovery and boot option menu.

Hotkey	Function	Description
F2	BIOS setup	Enter BIOS setup
F9	system recovery	Enter system recovery
F12	boot option	Enter boot option menu

Setup Your System for RAID 0/1

WARNING

- Please backup your data before you build and run RAID 0/1 on your system.
- RAID 1 needs two storage drives of the same specification and capacity in your laptop.
- RAID 0 needs two storage drives of the same specification in your laptop. Different capacity is acceptable.

1

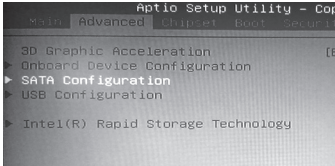

- Press F2 when computer starts to Enter BIOS setup utility.
- Go to Advanced > SATA configuration.

2

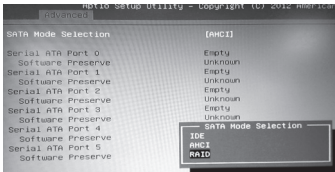

- Change "SATA Mode selection" from "AHCI" to "RAID".
- Press F10 to save and exit. The system will restart automatically.

3



- Once the system restarts. Go to "All Apps" found at the bottom of the screen on Windows 8 and execute Intel Rapid Storage program.

4



- You will see the Intel Rapid Storage Technology Screen, Click> Create.

5

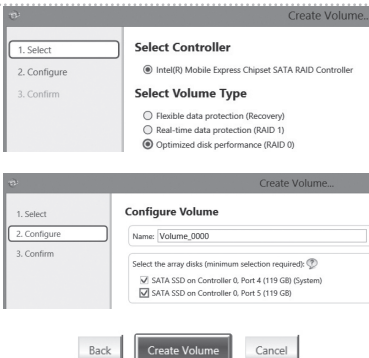

- Under Select Volume Type choose Optimized disc performance (RAID 0/1), Click > NEXT.
- Under Configure Volume you may set Name to your preferred name and select both controllers.
- Click > Next. You will see Confirm Volume Creation. Click > Create volume.
- Wait until the system migration is complete and restart the laptop.

Smart USB Backup Guide (Original: Recovery Image USB)

⚠ WARNING

- You can backup original recovery image through this application in case of losing by device damage.
- You can backup original recovery image to USB disk and restore the system if any storage system replacement with the recovery USB disk.
- Before you restore the system through the recovery USB disk, please make sure that you have already made the backup of your data.
- Please DO NOT shut down or un-plug the system when performing backup through recovery USB disk.

1



- Please plug in the USB disk which is at least 20GB in capacity to make the original image (backup the data in USB first. All data will be eliminated during the creation of recovery USB disk)

2



- Insert the driver disk to your optical drive and run the install of “Smart USB Backup” (for none-ODD model, please use USB ODD device or download from <http://www.gigabyte.com>)

3



- Run the “Smart USB Backup” after finishing the install.

4



- Select your USB disk from the drop-down list and start to create the recovery USB disk.

5

- The window will pop out when the creation of recovery disk is done.
- Please press F12 on starting the system when you need to restore the system. Select “boot from recovery USB disk” and the system will be restored.
- The time needed for restore will be around 30 mins(time needed may vary by USB disk model) .

Recovery Guide

System Recovery (Restore your laptop operating system)

When something is going wrong with the laptop operating system, the storage of the laptop has a hidden partition containing a full back up image of the operating system that can be used to restore the system to factory default settings.



Note

- If the storage has been switched or the partition deleted, the recovery option will no longer be available and a recovery service will be needed.
- The recovery function is only available on devices with O/S preinstalled. Devices with DOS do not have the recovery function.

Launch System Recovery

The system recovery feature is preinstalled before the laptop is shipped from the factory. The option menu allows you to launch the Windows recovery tool to reinstall the operating system to factory default.

The brief introduction below will show you how to start the recovery tool and restore your system.



All ready to go

Make sure your PC is plugged in. This will take a few minutes.

Windows 7 Recovery Guide

- 1 Turn off and restart the laptop.

2



During the laptop turn on process, press and hold F9 key to launch the tool.

3



The recovery will be activated and you will see the option buttons on the window. Click on "Recovery" to start it.



Caution

Once the "Recovery" is selected, your personal data and files will be deleted after the laptop starts restoring, and the operating system will be reset to factory default settings.

4



A progress indicator bar will show on the window when the recovery process is running. Please make sure the AC-adapter is plugged in and do not turn off the laptop.

5



Reboot the laptop after the system recovery is complete.

Windows 8.1 Recovery Guide

1

Turn off and restart the laptop.

2



During the laptop turn on process, press and hold F9 key to launch the tool.

3



Choose “Troubleshoot” to enter the recovery settings. (Also you can choose “Continue” to exit recovery system and continue to Windows 8.1 for files or data backup.)



There are two options for system recovery

- **Refresh your PC**

You can refresh your laptop to improve the system stability without losing your files.

- **Reset your PC**

If you want to remove all of your files, you can reset your PC completely.

Caution: All personal data and files will be lost.

4



- **Choose “Refresh your PC”**

Choose an account to continue.



Here are what will happen

- Your files and personalization settings won't be changed.
- Your PC settings will be restored to factory default settings.
- Apps from Windows Store will be kept.
- Apps you installed from discs or websites will be removed.
- A list of removed apps will be saved on your desktop.



■ Choose “Reset your PC”

▶ Just remove my files

Only personal data and files will be removed, but computer settings will be kept.

▶ Fully clean the drive

The drive will be completely restored to factory default settings. It takes more time. > [Click on “Reset” to execute recovery function.]



Here are what will happen

- All of your personal files and apps will be removed.
- Your PC settings will be restored to factory default settings.



■ Advanced options



System Restore

Use a restore point recorded on your PC to restore Windows.



System Image Recovery

Recover Windows using a specific system image file.



Automatic Repair

Fix problems that keep Windows from loading.



Command Prompt

Use the Command Prompt for advanced troubleshooting.



UEFI Firmware Settings

Change settings in your PC's UEFI firmware.



Startup Settings

Change Windows Startup behavior.

■ **Warranty & Service:**

Warranty and service and related information please refer to the warranty card or GIGABYTE service website as the below link:

<http://www.gigabyte.com/support-downloads/technical-support.aspx>

■ **FAQ:**

FAQ (Frequent Asked Questions) please refer to the below link:

<http://www.gigabyte.com/support-downloads/faq.aspx>