

AI Auto Tracking PTZ Camera

TR313V2 / TR311HWV2 / TR333V2

User Manual



Federal Communications Commission Statement

NOTE: This equipment has been tested and found to comply with the limits for a Class A digital device, pursuant to part 15 of the FCC Rules. These limits are designed to provide reasonable protection against harmful interference when the equipment is operated in a commercial environment. This equipment generates, uses, and can radiate radiofrequency energy and, if not installed and used in accordance with the instruction manual, may cause harmful interference to radio communications. Operation of this equipment in a residential area is likely to cause harmful interference in which case the user will be required to correct the interference at his own expense.

FCC Caution: Any changes or modifications not expressly approved by the party responsible for compliance could void the user's authority to operate this equipment.

This device complies with part 15 of the FCC Rules.

Operation is subject to the following two conditions:

- (1) This device may not cause harmful interference, and
- (2) this device must accept any interference received, including interference that may cause undesired operation.

Warning - This is a class A product. In a domestic environment, this product may cause radio interference in which case the user may be required to take adequate measures.

This Class A digital apparatus complies with Canadian ICES-003. Cet appareil numérique de la classe A est conforme à la norme NMB-003 du Canada.

Caution

Risk of explosion if battery is replaced by an incorrect type.

Dispose of used batteries in a safe and proper manner.

Remote Control Battery Safety Information

- Store batteries in a cool and dry place.
- Do not throw away used batteries in the trash. Properly dispose of used batteries through specially approved disposal methods.
- Remove the batteries if they are not in use for long periods of time. Battery leakage and corrosion can damage the remote control. Dispose of batteries safely and through approved disposal methods.
- Do not use old batteries with new batteries.
- Do not mix and use different types of batteries: alkaline, standard (carbon-zinc) or rechargeable (nickel-cadmium).
- Do not dispose of batteries in a fire.
- Do not attempt to short-circuit the battery terminals.

DISCLAIMER

No warranty or representation, either expressed or implied, is made with respect to the contents of this documentation, its quality, performance, merchantability, or fitness for a particular purpose. Information presented in this documentation has been carefully checked for reliability; however, no responsibility is assumed for inaccuracies. The information contained in this documentation is subject to change without notice.

In no event will AVer Information Inc. be liable for direct, indirect, special, incidental, or consequential damages arising out of the use or inability to use this product or documentation, even if advised of the possibility of such damages.

TRADEMARKS

“AVer” is a trademark owned by AVer Information Inc. Other trademarks used herein for description purpose only belong to each of their companies.

COPYRIGHT

©2022 AVer Information Inc. All rights reserved.

All rights of this object belong to AVer Information Inc. Reproduced or transmitted in any form or by any means without the prior written permission of AVer Information Inc. is prohibited. All information or specifications are subject to change without prior notice.

NOTICE

SPECIFICATIONS ARE SUBJECT TO CHANGE WITHOUT PRIOR NOTICE. THE INFORMATION CONTAINED HEREIN IS TO BE CONSIDERED FOR REFERENCE ONLY.

WARNING

- To reduce the risk of fire or electric shock, do not expose this appliance to rain or moisture. Warranty will be void if any unauthorized modifications are done to the product.
- Do not drop the camera or subject it to physical shock.
- Use the correct power supply voltage to avoid the damaging camera.
- Do not place the camera where the cord can be stepped on as this may result in fraying or damage to the lead or the plug.
- Hold the bottom of the camera with both hands to move the camera. Do not grab the lens or lens holder to move the camera.

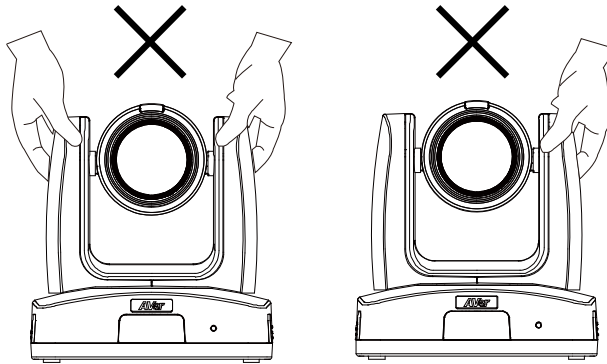

OK

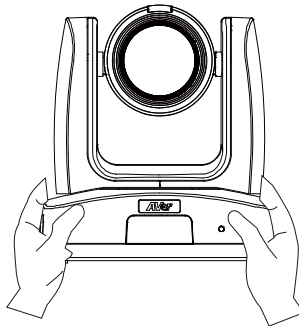

More Help

For FAQs, technical support, software and user manual download, please visit:

Headquarters

Download Center: <https://www.aver.com/download-center>
Technical Support: <https://www.aver.com/technical-support>

USA Branch office

Download Center: <https://www.averusa.com/business/support/>
Technical Support: <https://averusa.force.com/support/s/contactsupport>

Europe Branch office

Download Center: <https://www.avereurope.com/download-center>
Technical Support: <https://www.avereurope.com/technical-support>

Contact Information

Headquarters

AVer Information Inc.

<https://www.aver.com>

8F, No.157, Da-An Rd., Tucheng Dist., New Taipei City 23673, Taiwan

Tel: +886 (2) 2269 8535

USA Branch office

AVer Information Inc., Americas

<https://www.averusa.com>

668 Mission Ct., Fremont, CA 94539, USA

Tel: +1 (408) 263 3828

Toll-free: +1 (877) 528 7824

Technical support: support.usa@aver.com

Europe Branch office

AVer Information Europe B.V.

<https://www.avereurope.com>

Westblaak 134, 3012 KM, Rotterdam, The Netherlands

Tel: +31 (0) 10 7600 550

Technical support: eu.rma@aver.com

Japan Branch Office

アバー・インフォメーション株式会社

<https://jp.aver.com>

〒160-0023 日本東京都新宿区西新宿 3-2-26 立花新宿ビル 7 階

Tel: +81 (0) 3 5989 0290

テクニカル・サポート: VCInfo.JP@aver.com

Vietnam Branch Office

Công ty TNHH AVer Information (Việt Nam)

Tầng 5, 596 Nguyễn Đình Chiểu, P.3, Quận 3, Thành phố Hồ Chí Minh 700000, Việt Nam

Tel: +84 (0)28 22 539 211

Contents

Package Contents	1
Package Contents	1
Optional Accessories	1
Product Introduction	2
Overview	2
LED Indicators	2
Pan and Tilt Angle.....	3
Dimensions	4
Device Connection	7
PoE Connection	7
RS-232 and RS-422 Connection	8
Audio Input Connection	13
Video Output Connection.....	14
Camera Installation.....	17
Remote Control	18
Set Up the Camera	20
OSD Menu	20
IP Address Setup	20
Static IP	20
DHCP	21
OSD Menu Tree	22
Camera.....	22
Video Output.....	24
Network	24
Advanced Setting	24
System	25
Web Setup	26
Access the Web Interface of the Camera	26
Accessing the Camera via AVer IPCam Utility	26
Accessing the Camera via AVer PTZ Management	28
Live View	29

Camera Control	29
Preset.....	30
Camera Settings	32
Exposure	32
Image Process.....	33
Video & Audio	34
Network	36
Tracking Settings	39
Presenter Mode	41
Zone Mode	43
Hybrid Mode	45
System.....	47
Appendix	49
VISCA RS-232 Command Table	49
Visca over IP Settings.....	51
CGI Command	52

Package Contents

Package Contents

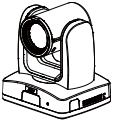

Camera Unit



Drilling Paper

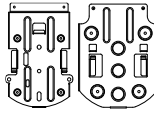

Ceiling Mount
Bracket (x2)



Quick Start Guide

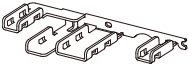

Cable Fixing Plate



M2 x 4mm
Screw (x3)

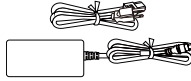

Power Adapter &
Power Cord



1/4"-20 L=6.5mm
Screw (x2)

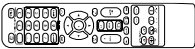

Remote Control



M3 x 6mm
Screw (x3)



DIN8 to D-Sub9
Cable



RS-232 In/Out
Y Cable

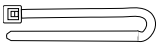

Cable Ties (x4)

*The power cord will vary depending on the standard power outlet of the country where it is sold.

Optional Accessories

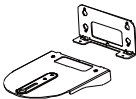

Wall Mount
Bracket



Camera Controller
(CL01)

* For details on optional accessories, please consult with your local dealer.

Product Introduction

Overview

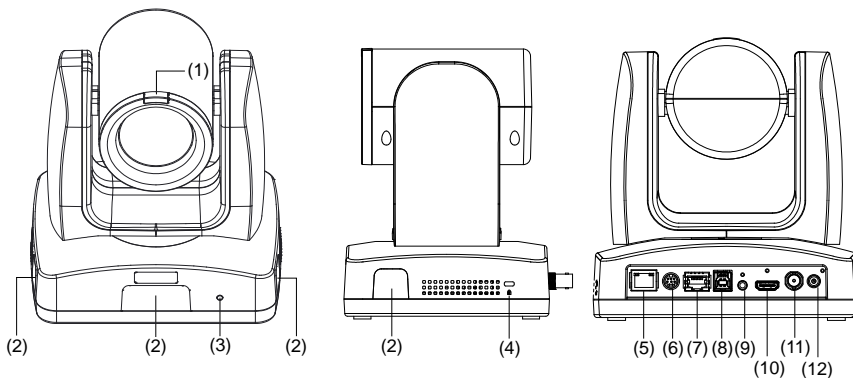

(1) Tally Lamp	(5) PoE+ IEEE 802.3AT	(9) Audio In*
(2) IR Sensor	(6) RS-232 Port	(10) HDMI Port
(3) LED Indicator	(7) RS-422 Port	(11) 3G-SDI**
(4) Kensington Lock	(8) USB 3.0 Port (Type-B)	(12) DC Power Jack

*Line input level: 1Vrms (max.).

*Mic input level: 50mVrms (max.); Supplied voltage: 2.5V.

**The model names with "H" do not have this feature.

LED Indicators

LED	Status
Blue (Blinking)	Auto Tracking On
Blue (Solid)	Normal Operation
Red (Blinking)	FW Updating
Orange (Blinking)	Camera Initialization
Orange (Solid)	Standby

Pan and Tilt Angle

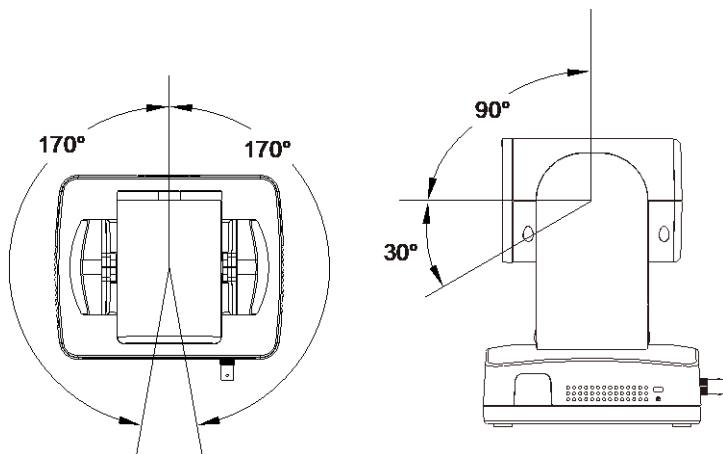

Dimensions

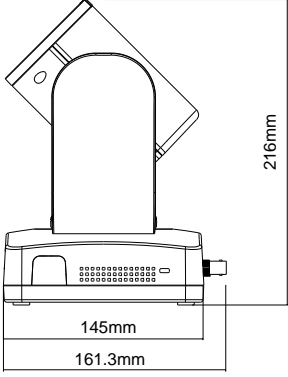
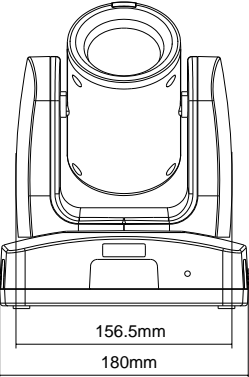
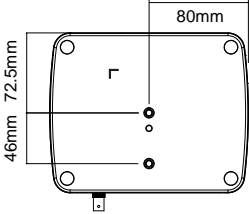
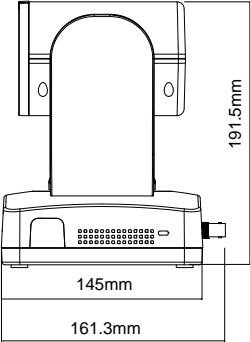
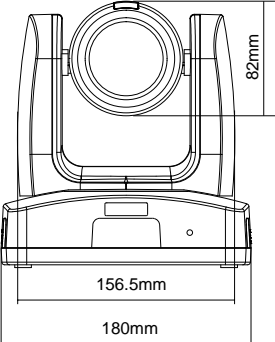

Ceiling Mount

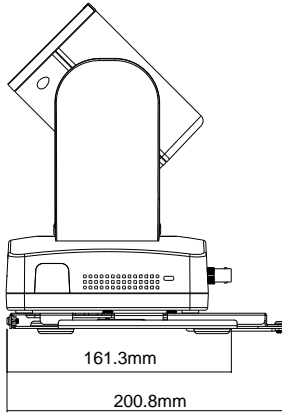
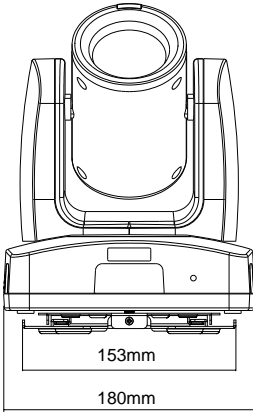
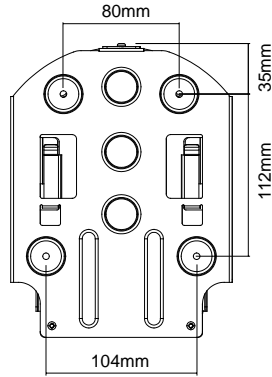
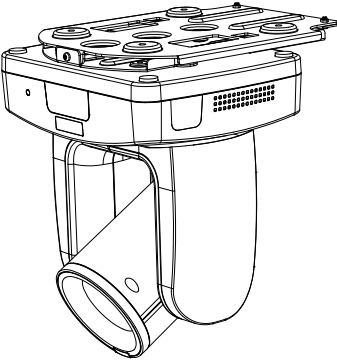

Wall Mount

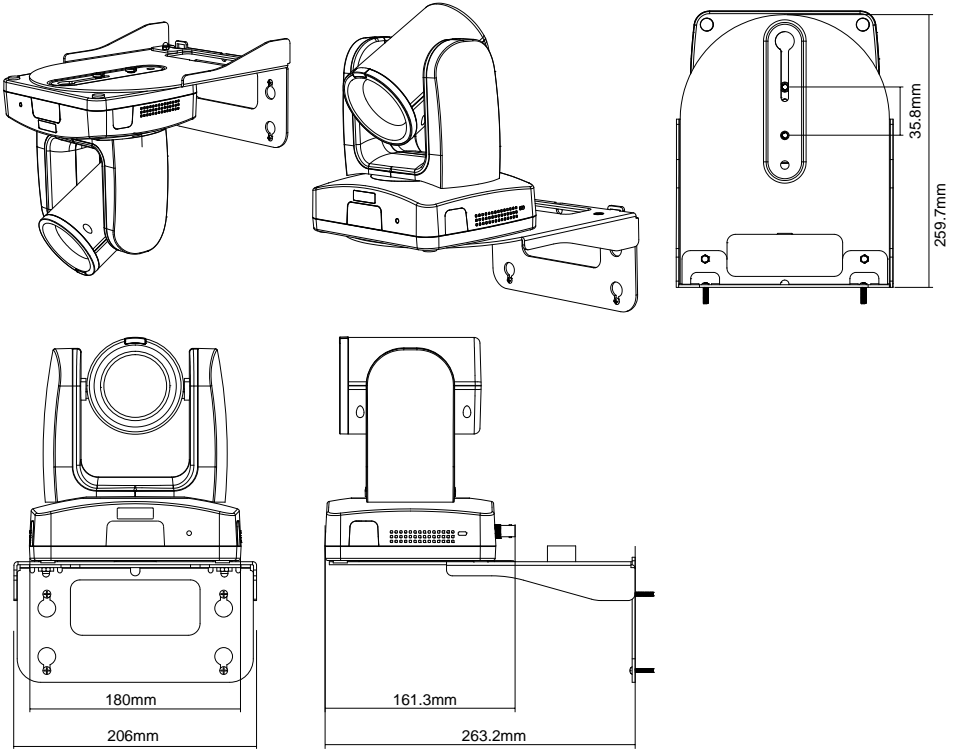

Device Connection

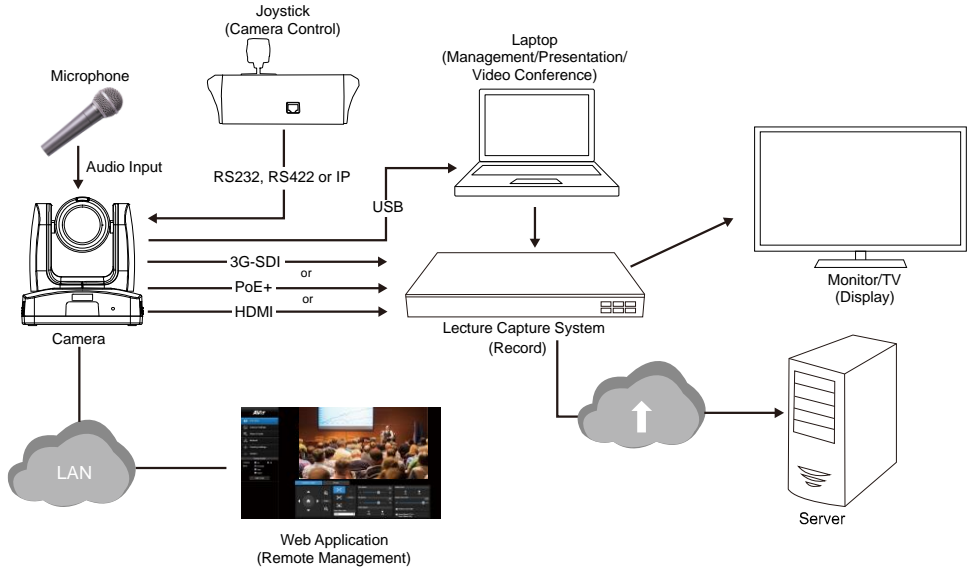

PoE Connection

Connect the camera to the router or switch through the PoE+ port.

[Note] Only support IEEE 802.3AT PoE+ standard.

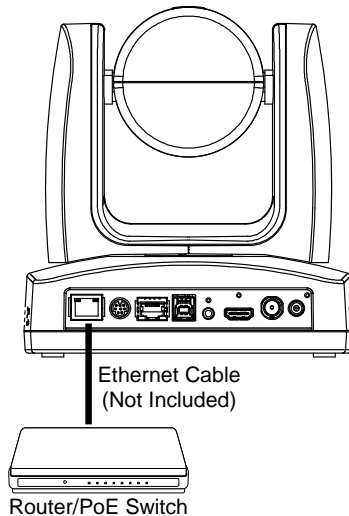

RS-232 and RS-422 Connection

Connect through the RS-232 or RS-422 for camera control.

- RS232

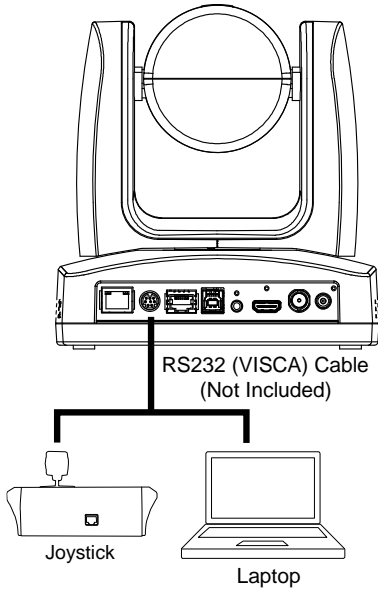

● **RS-232 Port Pin Definition**

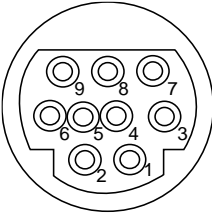

Function	Mini DIN9 PIN #	I/O Type	Signal	Description
VISCA IN	1	Output	DTR	Data Terminal Ready
	2	Input	DSR	Data Set Ready
	3	Output	TXD	Transmit Data
	6	Input	RXD	Receiver Data
VISCA OUT	7	Output	DTR	Data Terminal Ready
	4	Input	DSR	Data Set Ready
	8	Output	TXD	Transmit Data
	9	Input	RXD	Receiver Data
	5	Input	I/O	Detect DIN8/DIN9
---	Shield	---	GND	Ground

● **RS-232 mini DIN9 to mini DIN8 Cable Pin Definition**

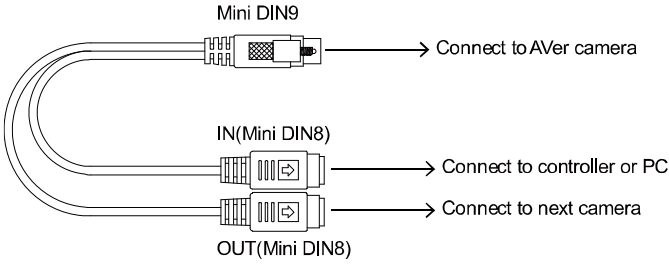

CIRCUITS:

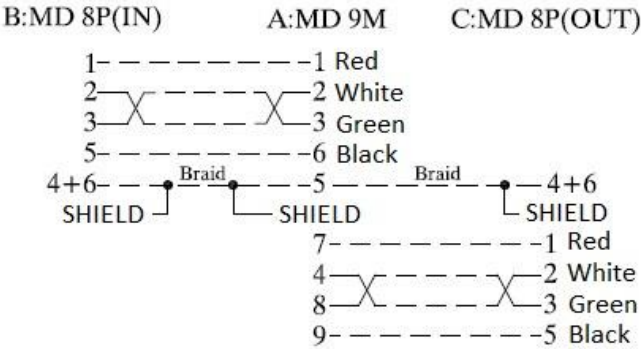

Mini DIN8 Cable Pin Definition

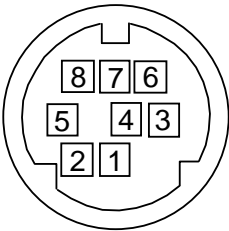

No.	Signal
1	DTR
2	DSR
3	TXD
4	GND
5	RXD
6	GND
7	NC
8	NC

● Din8 to D-Sub9 Cable Pin Definition

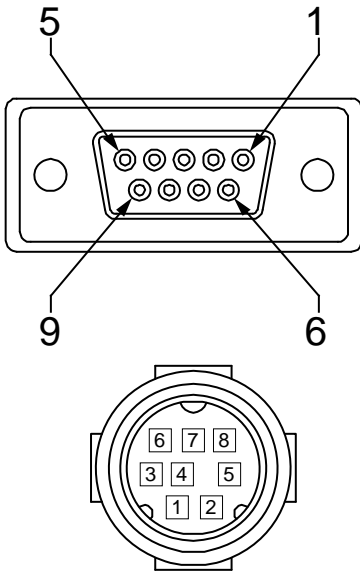

PIN OUT:

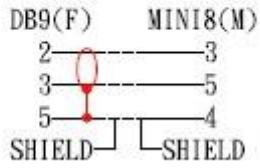

■ RS-422

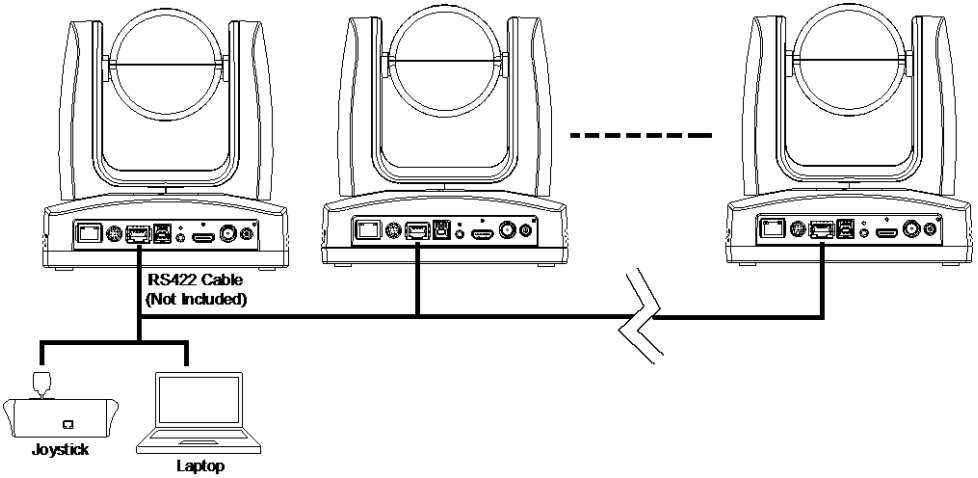

[Note] Use cat5e splitter for multi-camera connection.

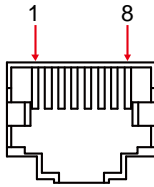

RS-422 Pin			
No.	Pin	No.	Pin
1	TX-	5	TX+
2	TX+	6	RX+
3	RX-	7	RX-
4	TX-	8	RX+

Cat5e splitter pin assignment:

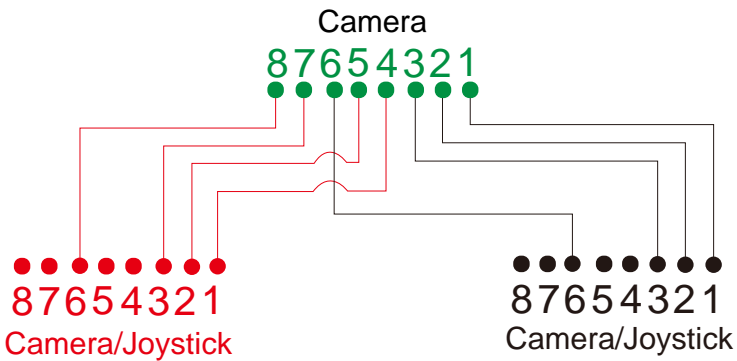

Audio Input Connection

Connect the audio device for audio receiving.

[Note]

- Line input level: 1Vrms (max.).
- Mic input level: 50mVrms (max.); Supplied voltage: 2.5V.

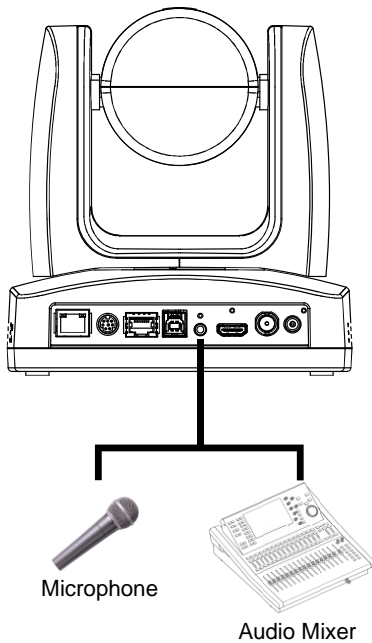

Video Output Connection

■ HDMI

Use the HDMI cable to connect with monitor or TV for video output.

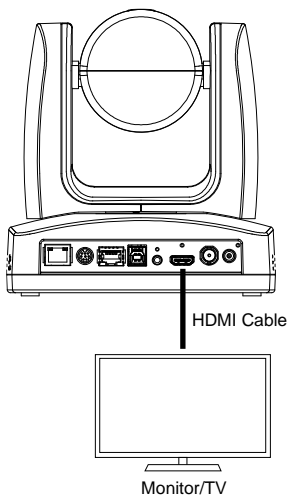

■ 3G-SDI

Connect to 3G-SDI monitor for video output.

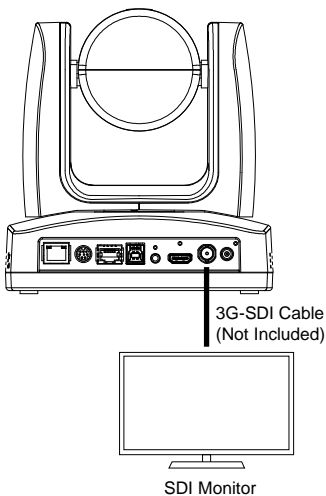

[Notes]

- HDMI and 3G-SDI monitors can be connected to camera and output live video simultaneously; Assuming HDMI monitor is well connected before the camera turned on, the OSD menu will be displayed on HDMI monitor in default.
- The model names with "H" do not have 3G-SDI.

Cable Fixing Plate Installation

1. Secure the cable fixing plate to the camera with 3 M2 x 4mm screws (included in the package).

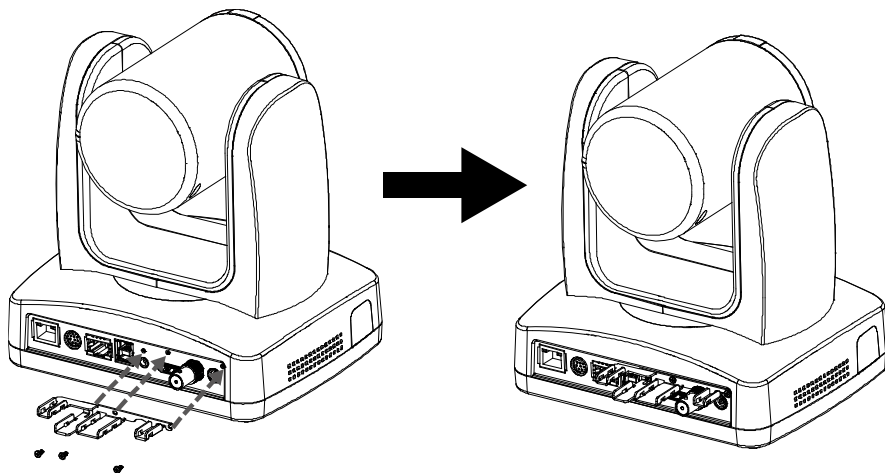

2. Plug in cables.

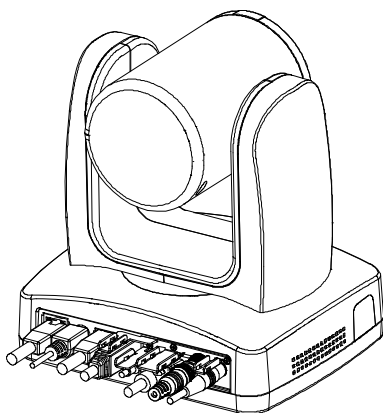

3. Use 4 cable ties to secure the cables and cable fixing plate.

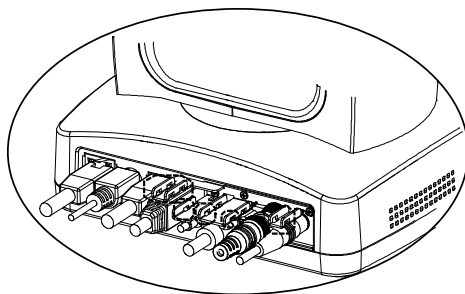

Ceiling Mount Installation

1. Secure the mount bracket on the ceiling.
Screw: 4 screws, M4 x 10mm (Not Included in the package)

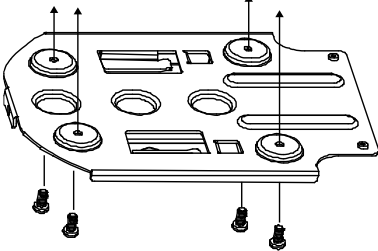

2. Install the mount bracket on the camera.
Screw: 2 screws, 1/4"-20 L=6.5mm (Included in the package)

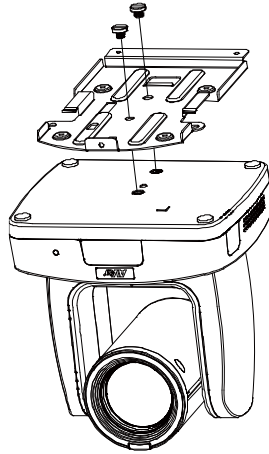

3. Slide the mount bracket with the camera into the mount bracket which secured on the ceiling.

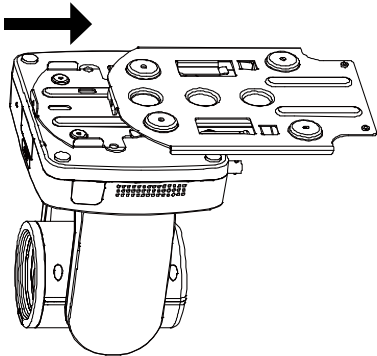

[Note] Connect necessary cables after sliding the camera into the mount bracket.

4. Secure the camera with screws.
Screw: 3 screws, M3 x 6mm (Included in the package)

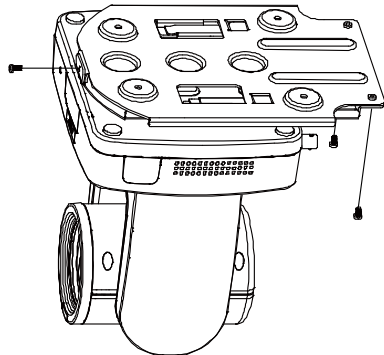

Camera Installation

- **Angle A:** less than 30°
- **Height B:** 2~3m from floor
- **Distance C:** longer than 3m away from podium
- **Position:** center of classroom
- **Distance between the camera and tracking target (presenter):**

Optical zoom ratio ability	Upper body size	Full body size
12X	3~16m	3~28m
16X	3~30m	4~55m
21X	3~40m	4~65m
30X	3~44m	3~76m

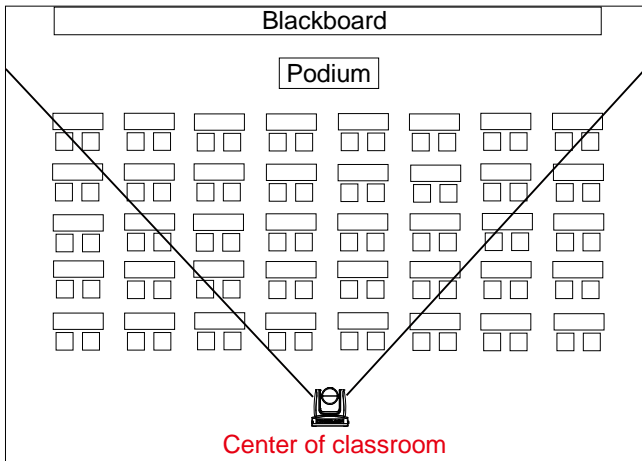
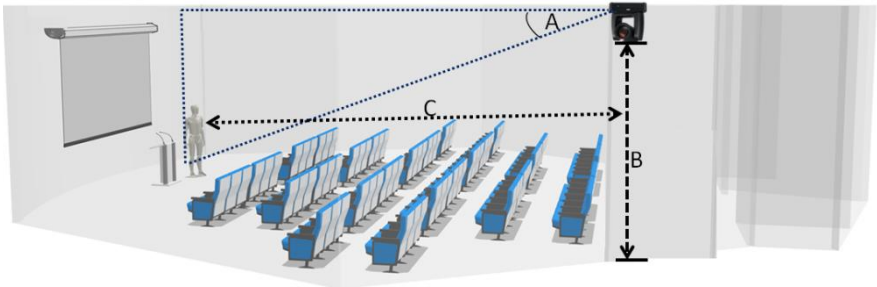

Remote Control

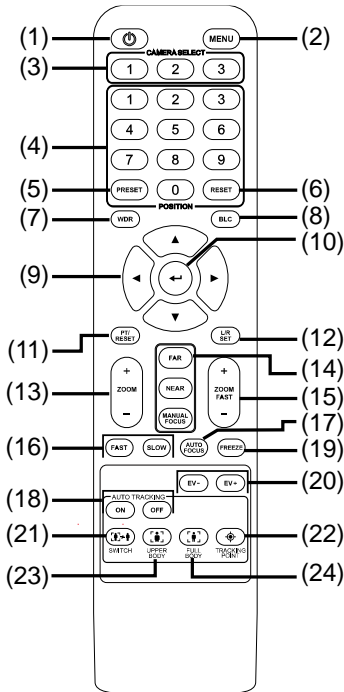

Name	Function
(1) Power	Turn the unit on/standby.
(2) Menu	Open and exit the OSD menu.
(3) Camera Select	CAM1 to CAM3 button Select a camera to operate.
(4) Numeric Pad	<ul style="list-style-type: none"> ■ Use for setting the preset position 0~9. ■ Press number button (0~9) to move the camera to pre-configured preset position 0~9.
(5) Preset	Press " Preset " + " Number button (0~9) " to set the preset position.
(6) Reset	Press " Reset " + " Number button (0~9) " to cancel pre-configured preset position.
(7) WDR	Turn on/off WDR function.
(8) BLC	Turn on/off backlight compensation.
(9) ▲, ▼, ◀, & ▶	Pan and tilt the camera.
(10) Enter	Access the OSD menu, confirm the selection or make a selection in OSD menu.
(11) PT Reset	Reset the Pan-Tilt position.
(12) L/R DIR	Left and right orientation setting. <ul style="list-style-type: none"> - Press "L/R DIR" + "1" button to reset setting. - Press "L/R DIR" + "2" button to move to opposite direction.

Name	Function
(13) Zoom +/-	Zoom in/out slowly.
(14) MF/Far/Near	Enable manual focus. Use Far/Near to adjust the focus.
(15) Zoom Fast +/-	Zoom in/out fast.
(16) Pan-tilt Fast/Slow	Pan-Tilt speed adjustment.
(17) AF	Auto focus.
(18) Auto Tracking	Auto Tracking on/off.
(19) Freeze	Freeze the live image.
(20) EV +/-	<ul style="list-style-type: none"> ■ Short press to adjust EV level. ■ Long press EV+ to turn on RTMP. ■ Long press EV- to turn off RTMP.
(21) Switch	Change presenter.
(22) Tracking Point	When presenter enters this area, the camera will return tracking point.
(23) Upper Body	Presenter's size on screen is upper body.
(24) Full Body	Presenter's size on screen is full body.

Set Up the Camera

OSD Menu

You can use the supplied Remote Control to operate the OSD Menu. Press the **MENU** button to call out the OSD menu and use the **▲**, **▼**, **◀**, **▶** and **↩** buttons to operate the OSD menu.

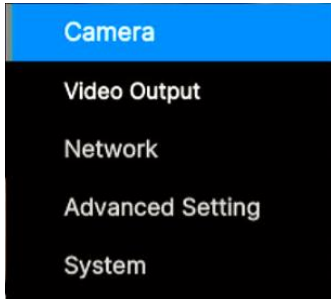

IP Address Setup

Static IP

1. Press the **MENU** button on the remote control to call out the OSD menu.
2. Go to **Network > Static IP**.

[Note] Turn the DHCP off before setting up static IP (**Network > DHCP > Off**).

3. Select the **IP Address**, **Gateway**, **Netmask** and **DNS** to configure. Press **↩** and use **◀**, **▶** and Numeric Pad to enter the data.

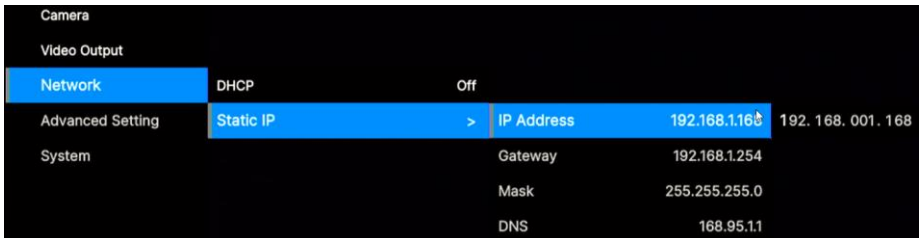

DHCP

1. Press the **MENU** button on the remote control to call out the OSD menu.
2. Go to **Network > DHCP > On**.

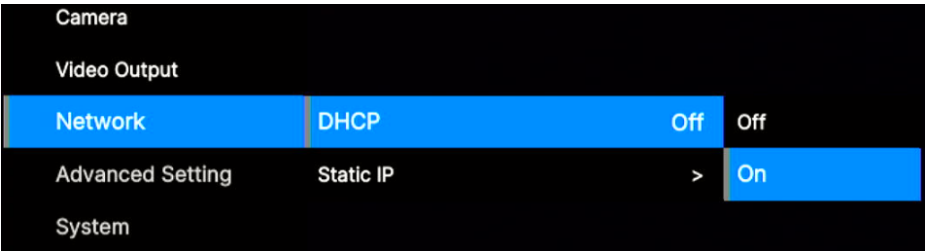

3. After turning the DHCP on, the user can go to **System > Information** to view the IP address.

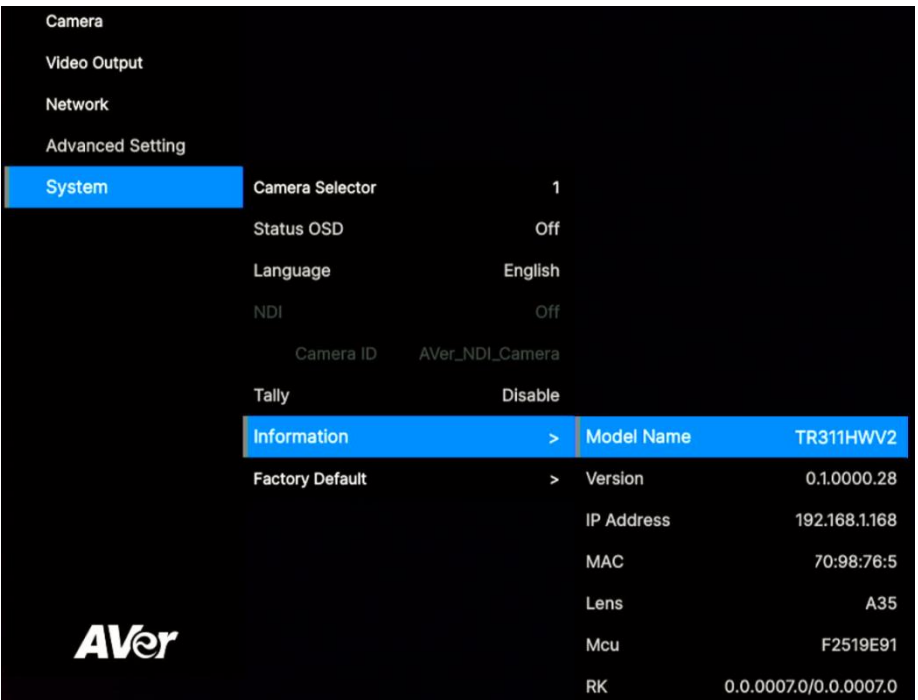

OSD Menu Tree

Camera

Set up camera parameters – Exposure Mode, White Balance, Pan Tilt Zoom, Noise Reduction, Saturation, Contrast, Sharpness, Mirror and Flip.

1 st Layer	2 nd Layer	3 rd Layer	4 th Layer	5 th Layer	
Camera	Exposure Mode	Full Auto	Exposure Value	-4/-3/-2/-1/0/1/2/3/4	
			Gain Limit Level	24dB/27dB/30dB/33dB/36dB /39dB/42dB	
			Slow Shutter	Off/On	
		Shutter Priority	Exposure Value	-4/-3/-2/-1/0/1/2/3/4	
			Shutter Speed	1/1, 1/2, 1/4, 1/8, 1/15, 1/30, 1/60, 1/90, 1/100, 1/125, 1/180, 1/250, 1/350, 1/500, 1/725, 1/1000, 1/1500, 1/2000, 1/3000, 1/4000, 1/6000, 1/10000	
			Gain Limit Level	24dB/27dB/30dB/33dB/36dB /39dB/42dB	
		Iris Priority	Exposure Value	-4/-3/-2/-1/0/1/2/3/4	
			Iris Level	F1.6/F1.8/F2.0/F2.4/F2.8/ F3.4/F4.0/F4.8/F5.6/F6.8/ F8.0/F11/F14/Close	
			Gain Limit Level	24dB/27dB/30dB/33dB/36dB /39dB/42dB	
			Slow Shutter	On/Off	
		Manual	Shutter Speed	1/1, 1/2, 1/4, 1/8, 1/15, 1/30, 1/60, 1/90, 1/100, 1/125, 1/180, 1/250, 1/350, 1/500, 1/725, 1/1000, 1/1500, 1/2000, 1/3000, 1/4000, 1/6000, 1/10000	
			Iris Level	F1.6/F1.8/F2.0/F2.4/F2.8/ F3.4/F4.0/F4.8/F5.6/F6.8/ F8.0/F11/F14/Close	
			Gain Level	0 dB/3 dB/6 dB/9 dB/12 dB /15 dB/18 dB/21 dB/24dB/ 27dB/30dB/33dB/36dB/39dB /42dB	
			Bright	0-31	-

1 st Layer	2 nd Layer	3 rd Layer	4 th Layer	5 th Layer
Camera	White Balance	Auto	-	-
		ATW	-	-
		Indoor	-	-
		Outdoor	-	-
		One push	-	-
		Manual	R Gain (0-255)	-
		B Gain (0-255)	-	
	Pan Tilt Zoom	Preset Speed	5/25/50/100/150/200	-
		Digital Zoom	Off/On	-
		Digital Zoom Limit	x2-x12	-
		Pan/Tilt Slow	Off/On	-
	Noise Reduction	Off/Low/Medium/High	-	-
	Saturation	0-10	-	-
	Contrast	0-4	-	-
	Sharpness	0-3	-	-
Mirror	Off/On	-	-	
Flip	Off/On	-	-	

Video Output

Select video resolution (2160p is only supported on certain models).

1 st Layer	2 nd Layer	3 rd Layer
Video Output	Priority Mode	2160p/1080p
	Frequency	50 Hz/59.94 Hz/60 Hz
	Resolution	2160P/30, 2160P/29.97, 1080P/60, 1080P/59.94, 1080P/30, 1080P/29, 1080I/60, 1080I/59, 720P/60, 720P/59.94, 2160P/25, 1080P/50, 1080P/25, 1080I/50, 720P/50

Network

Set up IP mode – DHCP or static IP.

1 st Layer	2 nd Layer	3 rd Layer
Network	DHCP	Off/On
	Static IP	IP Address, Gateway, Mask, DNS

Advanced Setting

1 st Layer	2 nd Layer	3 rd Layer	4 th Layer
Advanced Setting	Audio	Input Type	Line In
			MIC In
		Auto Gain Control	Off/On
		Noise Suppression	Off/Low/Normal
		Audio Volume	0-10
	Control	Serial Port	RS-232/RS-422
		Protocol	VISCA/PELCO D/PELCO P/AW
		Camera Address	1-7
		Baud Rate	4800/9600/38400
	Tracking	Off/On	-
	Tracking Mode	Presenter	-
		Zone	-
		Hybrid	-

System

- **Status OSD:** Enable/disable Preset status (Save Preset, Call Preset, Cancel Preset) display on the screen.
- **Camera Selector:** Set the camera ID 1~3 for using remote control on multiple cameras control (also see No.3 Camera Select in Remote Control chapter).
- **NDI:** Enable/disable NDI function.
- **Tally:** Enable tally function.

1 st Layer	2 nd Layer	3 rd Layer
System	Camera Selector	1-3
	Status OSD	Off/On
	Language	English/繁體中文/日本語/简体中文/한국어/ Tiếng Việt
	NDI	Off/On
	Tally	Disable/Enable
	Information	Model Name/Version/IP Address/MAC/Lens/Mcu/RK
	Factory Default	Off/On

Web Setup

Connect the camera from a remote site through the internet.

Access the Web Interface of the Camera

To access the Web interface of the camera, you have to find the IP address of the camera using **AVer IPCam Utility** or **AVer PTZ Management** software.

Accessing the Camera via AVer IPCam Utility

To find the IP address of your cameras using the IPCam Utility installer, follow the steps below.

1. Download the IPCam Utility from <https://www.aver.com/download-center> and run the IPCam Utility.
2. Click **Search**, and all available devices will be listed on the screen.
3. Select a camera from the list, the camera info will be displayed in the Settings field.

[Note] The default network of the camera is Static IP (192.168.1.168) and default ID/Password are **admin/admin**. If you want to configure the network to DHCP, input the ID/Password in the **Login** field, select the “camera model” on the list, select “DHCP” and then click the **Apply** button.

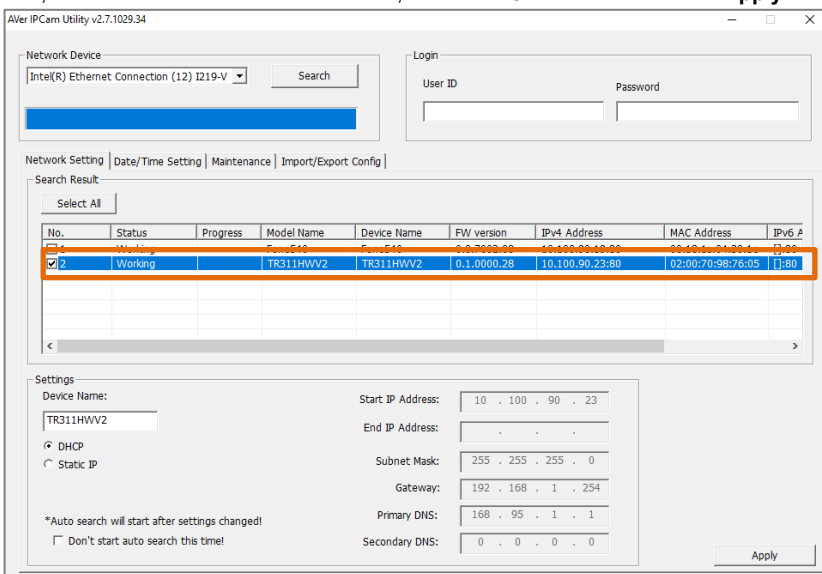

4. To access the Web interface, double-click on the IP address in the IPv4 Address column. For the first-time user, you will be prompted with a Login window to change the ID and password.

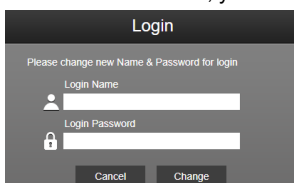

5. Login with the new ID/Password, the Web interface of the camera will be displayed (Chrome browser). Please refer to the Live View chapter for more details.

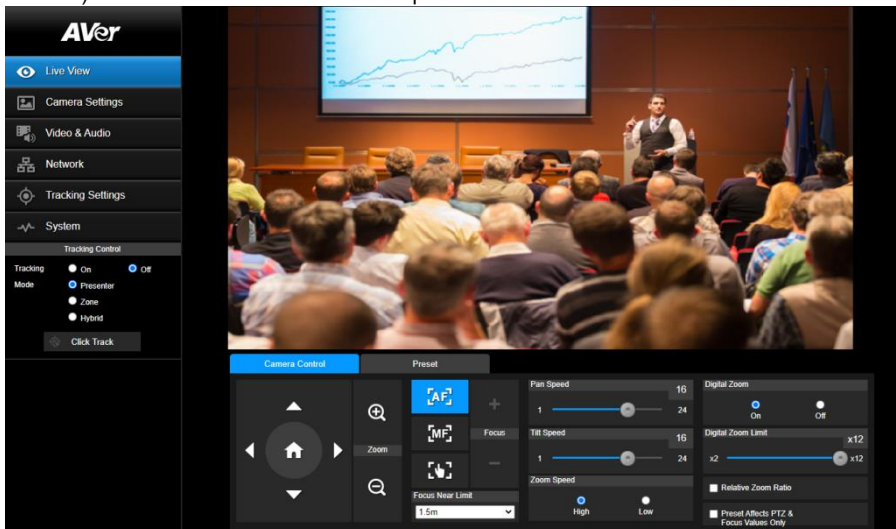

[Note] If IPCam utility cannot find the camera, please check the following:

1. Please make sure the Ethernet connection of the camera is well connected.
2. The camera and PC (IPCam Utility) are in the same LAN segment.

Accessing the Camera via AVer PTZ Management

To find the IP address of your cameras using the AVer PTZ Management, follow the steps below.

1. Download the AVer PTZ Management software from <https://www.aver.com/download-center>
2. Download the Windows program and install it.
3. After setting up the user ID and password, log in to the software (default User Name/Password: admin/admin).

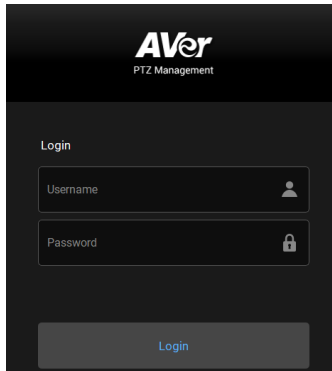

4. On the Main page of PTZ Management, click **Setup > Add** and then click **Auto Search**. The cameras connected on the same LAN with the computer will be displayed.

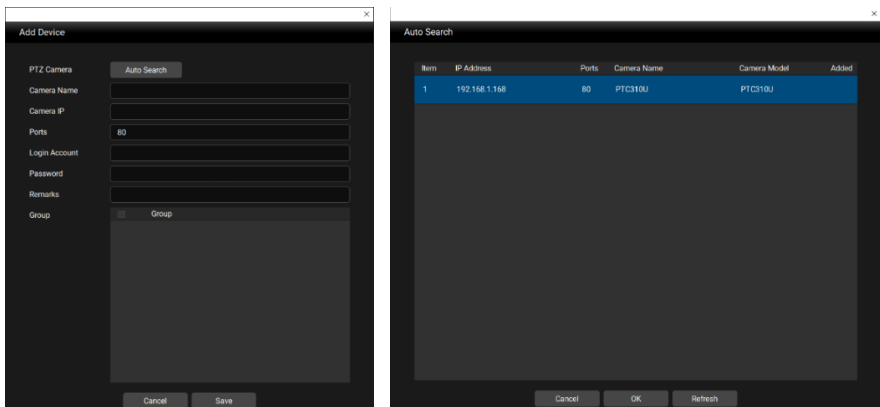

5. Click on the camera and input the camera ID and Password to add the camera to the device list (default ID/Password are **admin/admin**). Click the **Go to Web** button to access the Web interface of the camera.

Live View

You can control the camera and operate the Preset functions using this page.

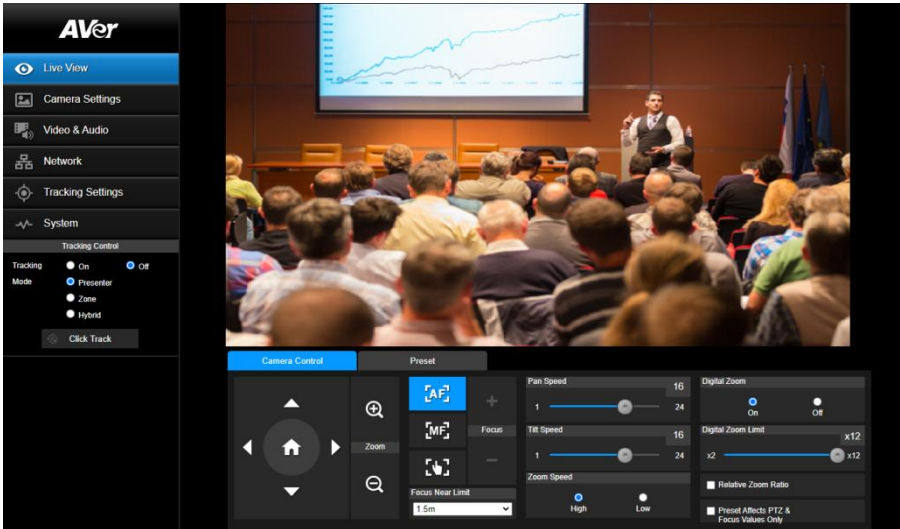





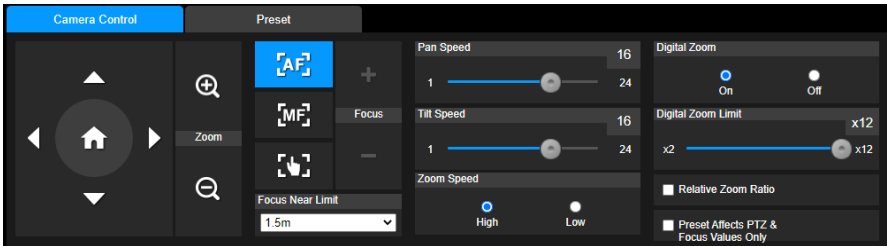

Camera Control

Click the **Camera Control** tab to display the panel below for operation.



Pan-Tilt-Zoom Control

Use , , , and  to navigate the camera view. Adjust the **Pan Speed** and **Tilt Speed** if necessary.

Use  and  to zoom in or zoom out the live image. You can also select **Zoom Speed (High/Low)**.

Click  to go back to home (default) position.

Focus

Auto Focus : Click for the camera to perform the auto focus.

Manual Focus : Click to manually adjust the focus. You can use the **Focus +** and **Focus -** buttons to adjust the focus.

One Push Focus : Click to automatically adjust the focus once.

Focus Near Limit: Set up the focus distance limit.

Digital Zoom

Digital Zoom: Select **On** or **Off** to enable or disable the function.

Digital Zoom Limit: Adjust the digital zoom from x2 to x12.

Relative Zoom Ratio: Enable/disable the function. If this function is enabled, the pan/tilt speed will be automatically adjusted based on the zoom ratio. The more the zoom ratio, the slower the pan/tilt speed.





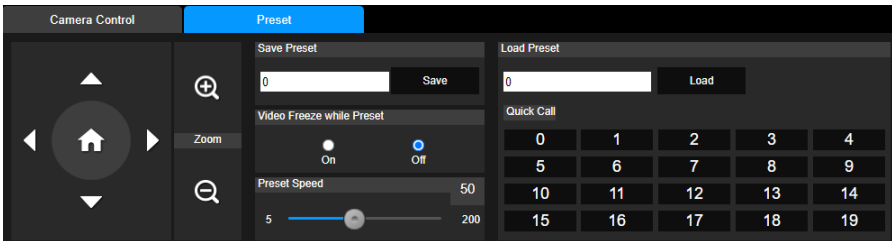

Preset Affects PTZ & Focus Values Only: Enable this function to save only the value of pan, tilt, zoom and focus for the configured preset points.

Preset

Click the **Preset** tab to display the panel below. You can configure and operate the preset positions.



To set up preset positions:

1. Select the **Preset** tab in live view page.
2. Use , ,  and  to navigate the camera view. Optionally use  and  to zoom in or zoom out the images.
3. Input a preset number (0~255) in the **Save Preset** column and click **Save** to save the position.
4. Follow Step 2 and 3 to set up more preset positions.

To perform the go to preset positions:

1. Input a preset number (0~255) in the **Load Preset** column or click a preset number (0~19) in the **Quick Call** section.
2. Click **Load**, the camera will move to the preset position.

When operating the go to preset positions, you can optionally adjust the **Preset Speed** or enable/disable the **Video Freeze while Preset** function.

- **Video Freeze with Preset:** When this function is turned on, the camera will not display the view along the path when moving from one position to another. The camera will only display the view of the positions.
- **Preset Speed:** Adjust the preset speed.

Camera Settings

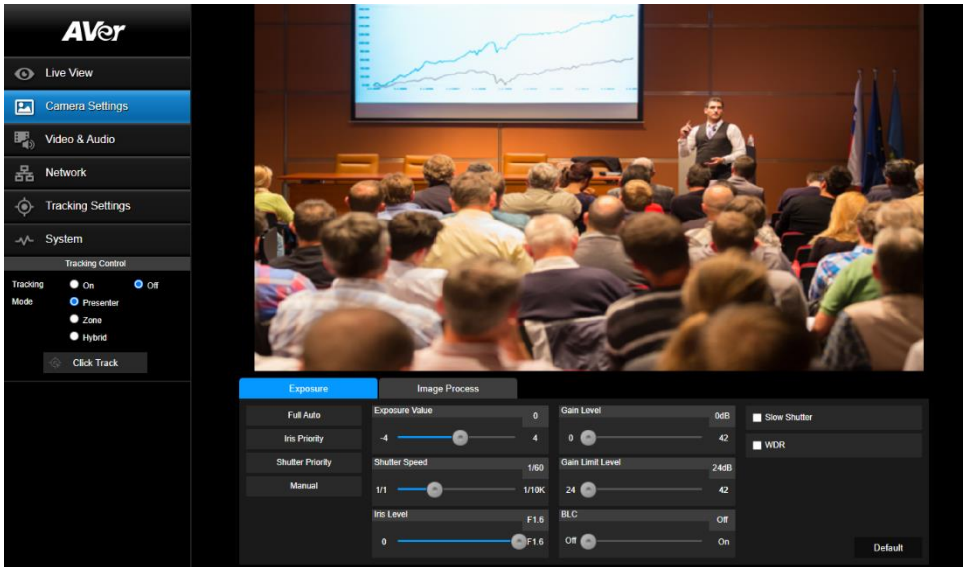

Exposure

Click the **Exposure** tab to display the panel below for configuration.

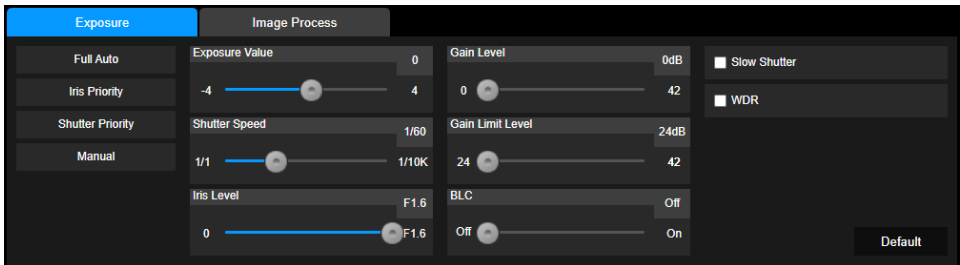

- **Exposure Mode:** Options include **Full Auto**, **Iris Priority**, **Shutter Priority** and **Manual**. Select an exposure mode and optionally adjust the value of **Exposure Value**, **Gain Level**, **Shutter Speed**, **Gain Limit Level**, **Iris Level**, and **BLC**.
- **Slow Shutter:** Enable/disable the function.
- **WDR:** Enable/disable the function.

Click the **Default** button to reset the **Exposure** settings to factory default.

Image Process

Click the **Image Process** tab to display the panel below for configuration.

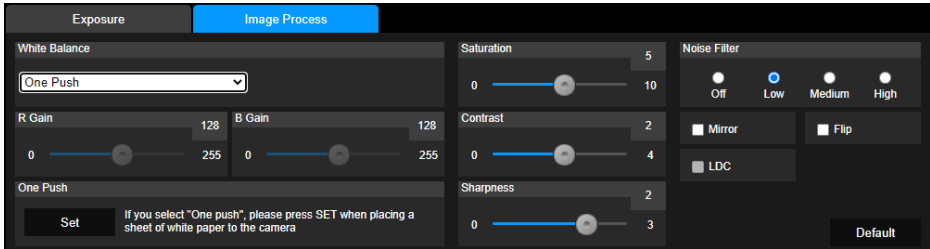

- **White Balance:** Options include **AWB**, **ATW**, **Indoor**, **Outdoor**, **One Push** and **Manual**. If **Manual** is selected, adjust the **R Gain** and **B Gain** manually. If **One Push** is selected, click the **Set** button in the **One Push** field when placing a white paper sheet in front of the camera lens.
- **Saturation:** Adjust the value.
- **Contrast:** Adjust the value.
- **Sharpness:** Adjust the value.
- **Noise Filter:** Select **Off**, **Low**, **Middle** or **High**.
- **Mirror:** Enable/disable the function.
- **Flip:** Enable/disable the function.
- **LDC:** Enable/disable the Lens Distortion Correction function. Enable this function to automatically correct image distortion caused under certain zoom level.

Video & Audio

You can configure video and audio settings on this page.

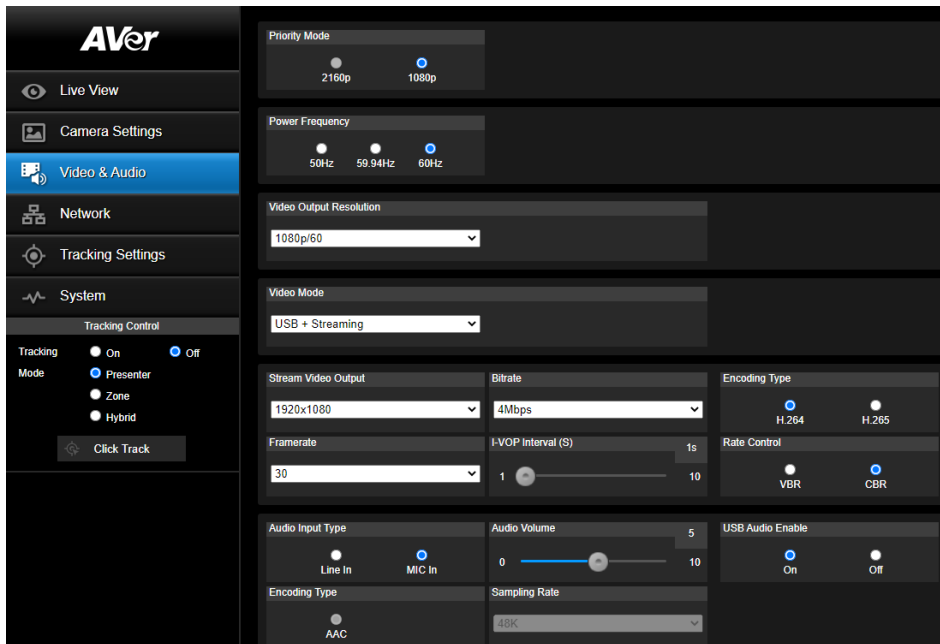

Video Setting:

- **Priority Mode:** Select **2160p** or **1080p**. 2160p is only available for certain models.
- **Power Frequency:** Select **50Hz**, **59.94Hz** or **60Hz** based on your region.
- **Video Output Resolution:** Select a resolution to display on your video output device.
- **Video Mode:** **Stream Only**, **USB Only**, or **USB + Streaming**. Frame rate is up to 60fps if **Stream Only** or **USB Only** is selected. Frame rate is up to 30fps if **USB + Streaming** is selected.
- **Stream Video Output:** Select a stream resolution on live view. Options include **3840x2160**, **1920x1080**, **1280x720**, **640x480** or **640x360**.
- **Framerate:** Select a framerate for live stream – **1**, **5**, **15**, **20** or **30** for power frequency **59.94Hz** or **60Hz**; **1**, **5**, **15**, **20** or **25** for power frequency **50Hz**.
- **Bitrate:** **512kbps**, **1Mbps**, **2Mbps**, **4Mbps**, **8Mbps**, **16Mbps**, **32Mbps** or **Auto**.
- **I-VOP Interval (S):** Move scroll bar to set the value – **1s** to **10s**.
- **Encoding Type:** Select **H.264** or **H.265**.
- **Rate Control:** Select **VBR** or **CBR**.

Audio Setting:

- **Audio Input Type:** Select an audio source for the audio input. **Line In** or **MIC In**.
- **Encoding Type:** Select **AAC**.
- **Audio Volume:** Adjust the audio volume.
- **Sampling Rate:** Select from **8K**, **16K**, **24K**, **32K**, **44.1K** or **48K**.

- **USB Audio Enable:** Select **On** or **Off**.

4K (2160p) Output Setup:

1. Make sure that your HDMI monitor and cable support 4K (HDMI 2.0 or above). Select 2160p for **Priority Mode** via either Web or OSD menu. Select **2160p/30** resolution at OSD menu to get 4K HDMI output. (3G-SDI does not support 4K.)
2. Select **USB Only** in the **Video Mode** field to get 4K USB output (live stream will be off).
3. Select **Stream Only** in the **Video Mode** field to get 4K live stream output (USB will be disabled).

Network

You can configure network settings on this page.

The screenshot shows the AVer network configuration page. The left sidebar has a 'Network' menu item highlighted. The main content area is divided into several sections: DHCP (On), Hostname (AVer), IP Address (10.100.90.17), Netmask (255.255.255.0), Gateway (10.100.90.254), DNS (168.95.1.1), RTMP Settings (Server URL, Stream Key), RTSP Security (Off), RTSP Audio Enable (On), HLS Settings (Stream URL), and SRT Settings (Destination IP, Port 8889, Encryption None, Latency 1000 ms, Passphrase). A 'Confirm' button is visible in the DHCP section, and 'Start Stream' and 'STOP' buttons are present in the RTMP, RTSP, and SRT sections.

- **DHCP:** You can set up the network to DHCP or Static IP.
DHCP: Select **On** to enable the **DHCP** button. The camera will be automatically assigned with the related IP settings. Click **Confirm** to save the settings.
Static IP: Select **Off** to disable the **DHCP** button and manually input the **IP Address**, **Netmask**, **Gateway** and **DNS**. Click **Confirm** to save the settings.
- **Hostname:** The default Hostname is AVer. You can change the hostname to be displayed on other devices, e.g. IP router.
- **RTMP Settings:** Configure the **RTMP** settings to transfer camera stream to the broadcasting platform, e.g. YouTube. To set up the **RTMP** settings:
 1. Input the **Server URL** and **Stream Key** of the broadcasting platform you use. Please refer to the instruction of the broadcasting platform you use to get the RTMP server URL and stream key.
 2. Click **Start Stream**, the camera stream should be transferred to your broadcasting platform.
 3. To stop broadcasting, click **STOP**.
- **RTSP Security:** Configure the **RTSP** settings to display camera streams on applications such as VLC, PotPlayer or Quick Time using the RTSP stream. To enable **RTSP**:
 1. Select **On** in the **RTSP Security** field.
 2. Select **On** in the **RTSP Audio Enable** field if you want to transfer audio.
 3. On your application, input the **RTSP** (ex: rtsp://192.168.1.100/live_st1) and ID/Password of the camera.
RTSP URL: rtsp://[IP address of the camera]/live_st1
ID/Password: Same with the Web login ID/Password.

- **HLS Settings:** To transfer the HLS streaming, input the **Stream URL** and click **Start Stream**. Click **STOP** to stop transferring.
- **SRT Settings:** Please refer to the below examples to set up SRT streaming.

Example 1 vMix:

Set the workstation and the TR300V2 camera in the same network. Check the workstation's IP address (Destination IP). Example:

```

C:\WINDOWS\system32\cmd.exe
Windows IP Configuration

Wireless LAN adapter Local Area Connection* 1:

    Media State . . . . . : Media disconnected
    Connection-specific DNS Suffix  . :

Ethernet adapter Ethernet:

    Connection-specific DNS Suffix  . :
    Link-local IPv6 Address . . . . . : fe80::8013:bd79:8b8c:2339%21
    IPv4 Address. . . . . : 192.168.1.10
    Subnet Mask . . . . . : 255.255.255.0
    Default Gateway . . . . . :

Wireless LAN adapter Wi-Fi:

    Connection-specific DNS Suffix  . : aver.com
    Link-local IPv6 Address . . . . . : fe80::685d:62c7:1f05:a46e%11
    IPv4 Address. . . . . : 10.100.200.67
    Subnet Mask . . . . . : 255.255.255.0
    Default Gateway . . . . . : 10.100.200.254

Ethernet adapter Bluetooth Network Connection:
  
```

Select SRT (Listener) from Stream Type in vMix Input Select window.

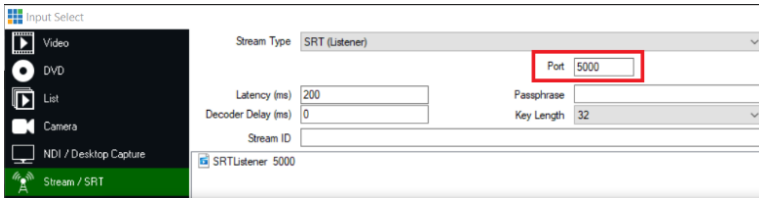

Enter the information into the SRT Settings TR300V2 web interface, then click on **Start Stream**, **Connect Status** shows **Connected**.

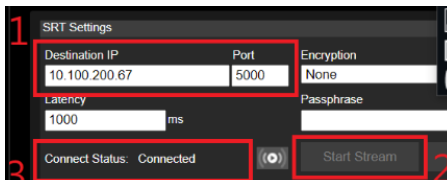

Example2 OBS (Open Broadcaster Software):

Set the workstation and the TR300V2 camera in the same network. Check the workstation's IP address (Destination IP). Example:

```
Connection-specific DNS Suffix . : aver.com
Link-local IPv6 Address . . . . . : fe80::f1dc:bda:87bd:ac1e%12
IPv4 Address. . . . . : 10.100.105.127
Subnet Mask . . . . . : 255.255.255.0
Default Gateway . . . . . : 10.100.105.254
```

Open OBS, add a scene, add a source, enter srt://Work Station IP:port?mode=listener
Example: srt://10.100.105.127:8889?mode=listener

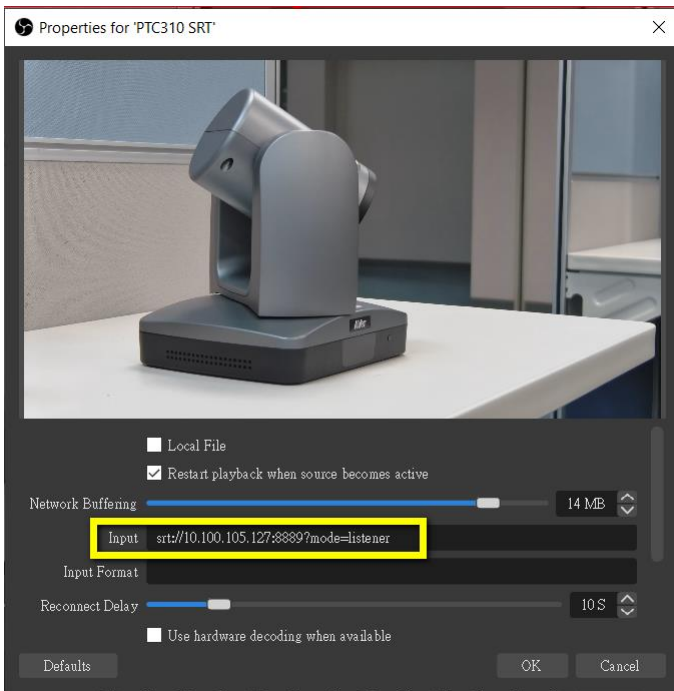

[Note] If there is no image, please try right-click on the source->Transform->Fit to screen to re-scale image.

Tracking Settings

You can set up the tracking modes and then use the **Tracking Control** panel to perform the tracking function.

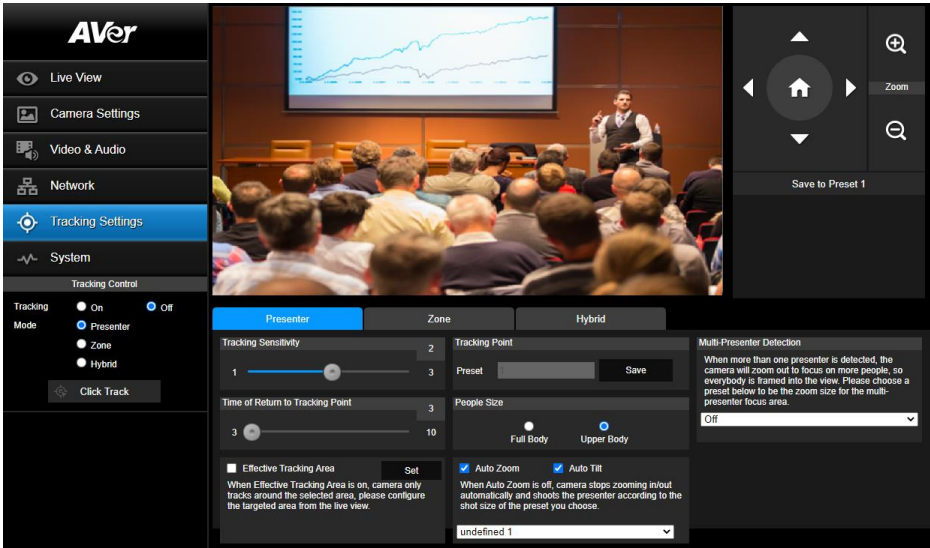

To perform the tracking function:

1. Open the camera Web interface and then click **Tracking Settings** on the left-side panel to configure the tracking modes. There are 3 modes:
 - **Presenter:** Camera will start tracking when a presenter appears on the camera view. The camera will focus on the targeted presenter with less background if the **Upper Body** is selected for the **People Size**. If the presenter is out of the camera view, the camera will return to the pre-configured **Tracking Point**.
 - **Zone:** Camera will focus on the pre-configured zones (preset areas) while tracking the presenter.
 - **Hybrid:** You can benefit from the advantages of both the **Presenter** and **Zone** modes. The camera will start tracking when a presenter is detected in the camera view. If the position where a presenter enters is pre-configured as a tracking zone (preset area), the camera will activate as Zone tracking.
2. After configuring the tracking modes, you can enable the tracking function using the **Tracking Control** panel on the Web interface.

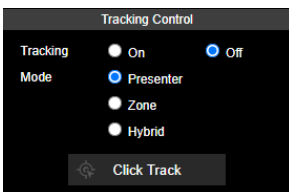

- a. Select **On** to enable the **Tracking** function.
- b. Select a **Tracking Mode: Presenter, Zone or Hybrid**.

3. Optionally click the **Click Track** button if you want to select a new target presenter to track.
 - a. Click the **Click Track** button, the targeted presenter will be highlighted with a red frame, while the other detected presenter will be highlighted with a blue frame.









- b. Click on the presenter with a blue frame, the targeted presenter will be changed to the clicked one.

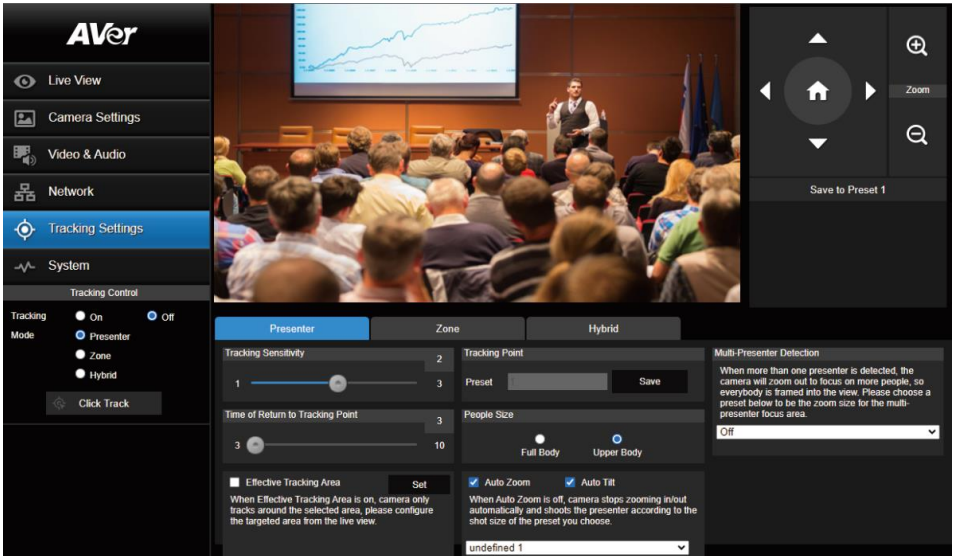

Presenter Mode

Camera will start tracking when object enters the camera live view.



1. Use , , , ,  and  to adjust the camera to a **Tracking Point** (preset position). Click **Save to Preset 1** to save the **Tracking Point**.
2. Adjust the value or enable the below functions.

Tracking Sensitivity: Slide the bar to adjust the sensitivity of the tracking function.

Tracking Point: When losing tracking target, the camera will go back to the **Tracking Point** (preset position). To set up the **Tracking Point**, refer to step 1.

Time of Return to Tracking Point: Set the idle time (sec.) for the camera to return to the **Tracking Point**. Slide the bar to adjust the value.

People Size: Select to track the presenter in **Full Body** (entire body) or **Upper Body** (up to 60% of body) while tracking.

Effective Tracking Area: You can optionally set up a tracking area. When **Effective Tracking Area** function is on, the camera only tracks around the selected area. Check the box to turn on the function and then click the **Set** button, a red frame appears in the preview window. Drag the upper-left or the lower-right corner of the red frame to adjust the tracking area.

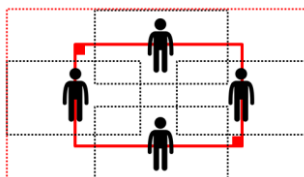

[Note] The position of the red solid frame corresponds to the central position of the presenter. The black dotted frames represent the tracking areas for different positions of the presenter. Therefore, the red dotted frame is the actual effective tracking area of the red solid frame.

Auto Zoom: When **Auto Zoom** is off, the camera stops zooming in/out automatically but keep the zoom size based on the preset point selected from the drop-down list below.

Auto Tilt: Check the box to enable the **Auto Tilt** function.

Multi-Presenter Detection: When more than one presenter is detected, the camera will zoom out to focus on more presenters in order to frame everyone within the live view. Select a preset point from the drop-down list below, the camera will keep the zoom size based on the selected preset point.

3. The **Presenter** tracking mode setup is completed. You can perform the function using the **Tracking Control** panel.

You can also use the supplied Remote Control to quickly set up the **Presenter Mode**.

1. Adjust the camera view properly and then save to preset 1 as the initial position.
2. Press the **Auto Tracking "On"** button to enable the function.
3. Press the **UPPER BODY** button to track the presenter with a closer view (up to 60% of body), or **FULL BODY** to track the entire presenter in the view.
4. Press **Switch** to switch between presenters. Initially the camera tracks the one who is in the center of view. Every switch follows the sequence: left to right, then back to far left one in the camera view (see picture below). To see which presenter is being tracked, press numeric key "7" for seven times to call/cancel engineering mode while tracking, you will see purple boxes shown on all human-outline objects, and who under yellow box is being tracked.

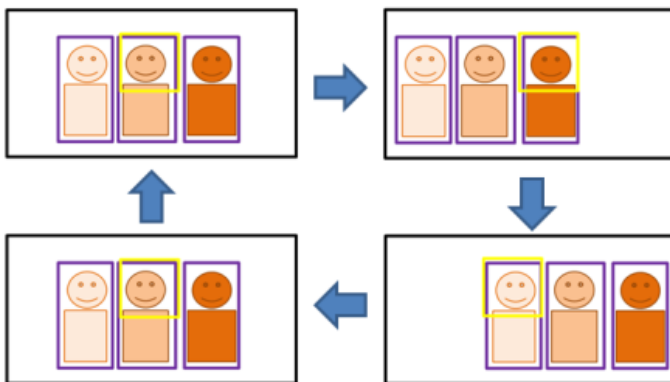

Zone Mode

Set up the block areas for the camera to detect the presenter and track the presenter when the presenter appears within the pre-configured areas (preset areas).

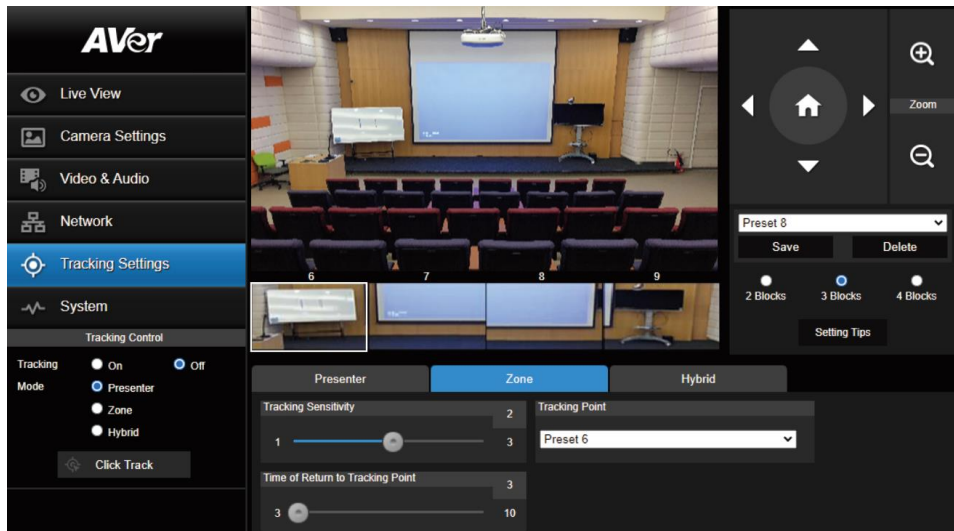

1. To configure the preset areas:

- Select the number of blocks (**2 Blocks**, **3 Blocks** or **4 Blocks**) you want to configure for the preset areas. Up to 4 preset areas can be configured.
- Select a preset number from the drop-down list (**Preset 6 ~ 9**).
- Use , , , , and to move the camera to the desired position.
- Click **Save** to save the position to the selected preset number. A preset thumbnail will be displayed below the preview window.
- Repeat the steps to set up more preset areas.

[Note] To ensure smooth transition while tracking the presenter, please overlap the set up preset areas. Do not separate the preset areas.

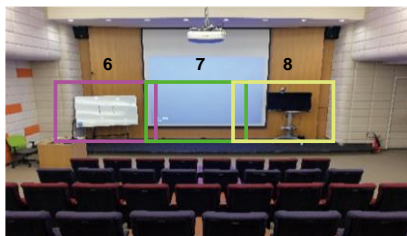

Ensure to overlap the preset areas

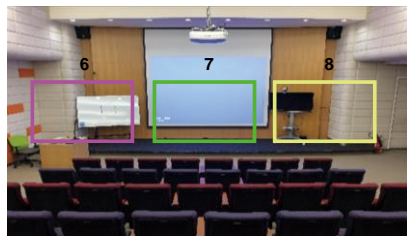

Do not separate the preset areas

[Note] Set up the preset view to clearly see the presenter at least complete half body (60% upper body) to ensure tracking accuracy. Make sure there is no any other human-outline poster/TV/monitor in the background. The result of the **Zone Mode** is illustrated as below.



2. Adjust the value or enable the below functions.

Tracking Sensitivity: Slide the bar to adjust the sensitivity of the tracking function.

Tracking Point: When losing tracking target, the camera will go back to the **Tracking Point** (preset position). Select a **Tracking Point** from the drop-down list below.

Time of Return to Tracking Point: Set the idle time (sec.) for the camera to return to the **Tracking Point**. Slide the bar to adjust the value.

3. The **Zone** tracking mode setup is completed. You can perform the function using the **Tracking Control** panel.

You can also use the supplied Remote Control to quickly set up the **Zone Mode**.

By default, 2 blocks has initially selected if you use the Remote Control to set up the **Zone Mode**. If you want to configure more blocks, you will have to use the Web interface for setup.

1. Adjust the camera view properly and then save to preset 6 and preset 7. By default, preset 6 is initially selected to be the first position to set up.
2. Long press **Tracking Point** to switch tracking mode from **Presenter Mode** to **Zone Mode** (the hotkey supported at firmware v0.0.0000.21 or later).
3. Press the **Auto Tracking "On"** button to enable the function.





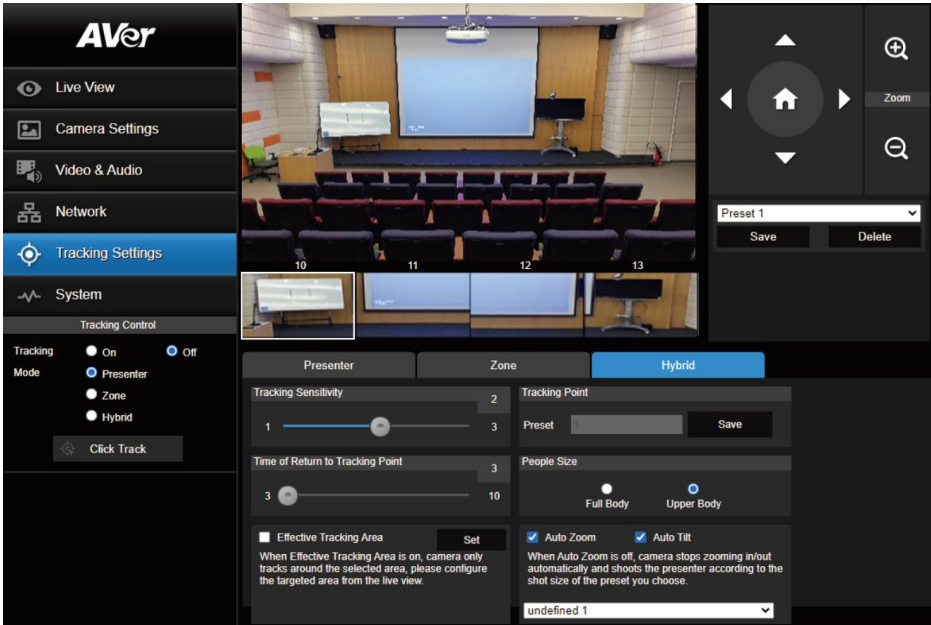

Hybrid Mode

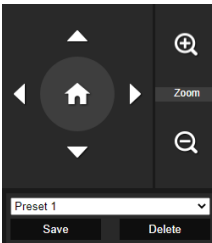





You can benefit from the advantages of both the **Presenter** and **Zone** modes. The camera will start tracking when a presenter is detected in the camera view. If the position where a presenter enters is pre-configured as a tracking zone (preset area), the camera will activate as Zone tracking.



1. Set up a **Tracking Point**. When losing tracking target, the camera will go back to the **Tracking Point** (preset position). To set up the **Tracking Point**:



- a. Select **Preset 1** from the drop-down list.
- b. Use , , , ,  and  to adjust the camera view.
- c. Click **Save** to save this preset position as the **Tracking Point**.

2. To configure the zones (preset areas):
 - a. Select a preset number from the drop-down list (**Preset 10 ~ 13**).
 - b. Use , , , ,  and  to move the camera to the desired position.
 - c. Click **Save** to save the position to the selected preset number. A preset thumbnail will be displayed below the preview window.
 - d. Repeat the steps to set up more preset areas.

[Note] To better perform the **Hybrid Mode**, do not overlay the zones (preset areas) nor configure the zones close to each other. It's recommended to leave some distance among the zones.



3. Adjust the value or enable the below functions.

Tracking Sensitivity: Slide the bar to adjust the sensitivity of the tracking function.

Tracking Point: When losing tracking target, camera will go back to the **Tracking Point** (preset position). To set up the **Tracking Point**, refer to step 1.

Time of Return to Tracking Point: Set the idle time (sec.) for the camera to return to the **Tracking Point**. Slide the bar to adjust the value.

People Size: Select to track the presenter in **Full Body** (entire body) or **Upper Body** (up to 60% of body) while tracking.

Effective Tracking Area: When **Effective Tracking Area** function is on, the camera only tracks around the selected area. Check the box to turn on the function and then click the **Set** button, a red frame appears in the preview window. Drag the upper-left or the lower-right corner of the red frame to adjust the tracking area.

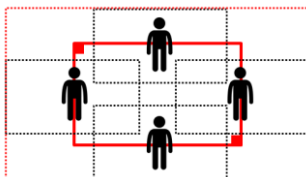

[Note] The position of the red solid frame corresponds to the central position of the presenter. The black dotted frames represent the tracking areas for different positions of the presenter. Therefore, the red dotted frame is the actual effective tracking area of the red solid frame.

Auto Zoom: When **Auto Zoom** is off, the camera stops zooming in/out automatically but keep the zoom size based on the preset point selected from the drop-down list below.

Auto Tilt: Check the box to enable the **Auto Tilt** function.

4. The **Hybrid** tracking mode setup is completed. You can perform the function using the **Tracking Control** panel.

System

You can view the system information, or configure some system settings on this page.

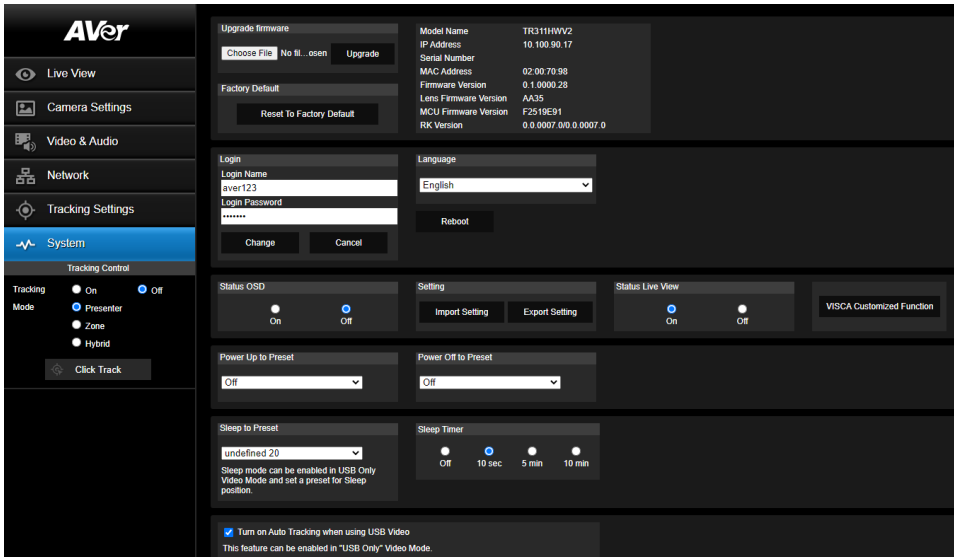

- **Upgrade firmware:** Follow below steps to upgrade the firmware.
 1. Download the newest firmware from <https://www.aver.com/download-center/> .
 2. On the Web page, go to **System > Upgrade firmware**.
 3. Click **Choose File** to select the firmware.
 4. Click **Upgrade** to start upgrading the firmware.
 5. Refresh the browser after the upgrade process is complete.
- **Factory Default:** Clear all values and reset the camera back to factory default values.
- **Camera Information:** Displays the camera information.
- **Login:** The default login ID and password are **admin/admin**. To change the login ID and password, input the new login ID and password and then click **Change**.
- **Language:** Change the Web UI language.
- **Status OSD:** Enable/disable to display the status info on the live view. When operating the Preset (Save Preset, Call Preset, Cancel Preset), Zoom or Tracking functions, the status will be displayed on the live screen.
- **Setting:** Click **Import Setting** to import camera configurations. Click **Export Setting** to export camera configurations.
- **Status Live View:** Select **On** to display live view. Select **Off** to close live view.
- **VISCA Customized Function:** Configure the settings and then click **OK**.
- **Power Up to Preset:** If this function is enabled, after camera power-up, the camera will move to the input preset position. To set up this function, input a preset position and then click **Save**. Ensure the preset positions have been pre-configured before enabling this function.

- **Power Off to Preset:** If this function is enabled, when power-off the camera, the camera will move to the input preset position. To set up this function, input a preset position and then click **Save**. Ensure the preset positions have been pre-configured before enabling this function.
- **Sleep to Preset:** Select a pre-configured preset point for the Sleep mode. When the camera enters the Sleep mode, the camera will turn to the selected preset point.
- **Sleep Timer:** Set up a duration for the sleep timer. When there is no UVC connection and timer is up, the camera will enter the sleep mode. You can select **Off** to disable the sleep mode. To perform this function, ensure to select **USB Only** in the **Video & Audio > Video Mode** setup field.
- **Turn on Auto Tracking when using USB Video:** You can enable the **Auto Tracking** function when using USB video. To perform this function, ensure to select **USB Only** in the **Video & Audio > Video Mode** setup field.

Appendix

VISCA RS-232 Command Table

Command Set	Command	Command Packet	Comments
CAM_Power	On	8x 01 04 00 02 FF	Power ON/OFF
	Off	8x 01 04 00 03 FF	
	Stop	8x 01 04 07 00 FF	
CAM_Zoom	Tele(Variable)	8x 01 04 07 2p FF	p=0 (Low) to 7 (High)
	Wide(Variable)	8x 01 04 07 3p FF	
	Direct	8x 01 04 47 0p 0q 0r 0s FF	pqrs: Zoom Position - PTC310: 0x0000-0x6f20 PTC330: 0x0110-0x6f40
CAM_Focus	Stop	8x 01 04 08 00 FF	
	Far (Standard)	8x 01 04 08 02 FF	
	Near (Standard)	8x 01 04 08 03 FF	Each 'Far/Near' needs a 'stop'
	Auto Focus	8x 01 04 38 03 FF	
	Manual Focus	8x 01 04 38 03 FF	
	One Push	8x 01 04 18 01 FF	
CAM_WB	Direct	8x 01 04 47 0p 0q 0r 0s FF	pqrs: Zoom Position
	Auto	8x 01 04 35 03 FF	Normal Auto
	ATW	8x 01 04 35 04 FF	
	Indoor	8x 01 04 35 01 FF	
	Outdoor	8x 01 04 35 02 FF	
	One Push WB	8x 01 04 35 03 FF	One Push WB mode
CAM_RGain	Manual	8x 01 04 35 05 FF	Manual Control mode
	One Push	8x 01 04 10 05 FF	One Push WB Trigger
	Up	8x 01 04 03 02 FF	Manual Control of R Gain
CAM_BGain	Down	8x 01 04 03 03 FF	
	Up	8x 01 04 04 02 FF	Manual Control of B Gain
CAM_AE	Down	8x 01 04 04 03 FF	
	Full Auto	8x 01 04 39 03 FF	Automatic Exposure mode
	Manual	8x 01 04 39 03 FF	Manual Control mode
	Shutter Priority	8x 01 04 39 04 FF	Shutter Priority Automatic Exposure mode
	Iris Priority	8x 01 04 39 08 FF	Iris Priority Automatic Exposure mode
	Bright	8x 01 04 39 0D FF	Bright Mode (Manual control)
CAM_Shutter	Up	8x 01 04 0A 02 FF	Shutter Setting
	Down	8x 01 04 0A 03 FF	
CAM_Iris	Up	8x 01 04 0B 02 FF	Iris Setting
	Down	8x 01 04 0B 03 FF	
CAM_Gain	Up	8x 01 04 0C 02 FF	Gain Setting
	Down	8x 01 04 0C 03 FF	
CAM_Bright	Up	8x 01 04 0D 02 FF	Bright Setting
	Down	8x 01 04 0D 03 FF	
	Up	8x 01 04 0E 02 FF	Exposure Compensation Amount Setting
CAM_Backlight	Down	8x 01 04 0E 03 FF	
	On	8x 01 04 33 02 FF	Back Light Compensation ON/OFF
	Off	8x 01 04 33 03 FF	
CAM_Preset	Reset	8x 01 04 3F 00 pp FF	
	Set	8x 01 04 3F 01 pp 1E	pp: Preset Number 0x00-0xFF
	Recall	8x 01 04 3F 02 pp FF	
CAM_Menu	On/Off	8x 01 06 06 1D FF	Display ON/OFF
	Up	8x 01 06 02 1V WW 03 01 03 FF	
Pan-tilt Drive	Down	8x 01 06 01 1V WW 03 02 FF	
	Left	8x 01 06 01 1V WW 01 03 FF	
	Right	8x 01 06 01 1V WW 02 03 FF	VV: Pan speed setting 0x01 (low speed) to 0x18 (high speed)
	Up/Left	8x 01 06 01 1V WW 01 01 FF	WW: Tilt speed setting 0x01 (low speed) to 0x18 (high speed)
	Up/Right	8x 01 06 01 1V WW 02 01 FF	
	Down/Left	8x 01 06 01 1V WW 01 02 FF	
	Down/Right	8x 01 06 01 1V WW 02 02 FF	
	Stop	8x 01 06 01 1V WW 01 03 FF	
	Home	8x 01 06 04 FF	
	Reset	8x 01 06 05 FF	
Absolute Position (v26 or above)	Set	8x 01 06 02 1V WW 0Y 0Y 0Y 0Z 0Z 0Z 0Z FF	VV: Pan speed setting 0x01 (low speed) to 0x18 (high speed) WW: Tilt speed setting 0x01 (low speed) to 0x18 (high speed) YYYY: Pan Position 8A14 to 762C (CENTER 0000) ZZZZ: Tilt Position 468B to E898 (Image Flip: 0FF) (CENTER 0000)
CAM_WDR	On	8x 01 04 3D 02 FF	Wdr ON/OFF
	Off	8x 01 04 3D 03 FF	
CAM_MenuEnter	On	8x 01 7E 01 02 00 01 FF	Enter-Submenu
	Tally Lamp ON	8x 01 7E 01 0A 00 02 FF	
Tally Lamp OFF	Freeze On	8x 01 7E 01 0A 00 03 FF	
	Freeze Off	81 01 04 62 02 FF	Freeze On Immediately
	Freeze On	81 01 04 62 22 FF	Freeze Off Immediately
Freeze	Preset Freeze On	81 01 04 62 22 FF	Freeze On When Running Preset
	Preset Freeze Off	81 01 04 62 23 FF	Freeze Off When Running Preset
	On	8x 01 04 7D 02 FF	Auto tracking ON/OFF
Auto Tracking	Off	8x 01 04 7D 03 FF	
	Set	8x 01 04 3F 01 pp FF	pp: 0x00 to 0xFF normal preset pp: 0x5F => Turn on OSD menu pp: 0xA0 => Full Body pp: 0xA1 => Upper Body pp: 0xA2 => Tracking Point pp: 0xA3 => Switch pp: 0xA4 => Presenter mode (supported in FW v25 or newer) pp: 0xA5 => Zone mode (supported in FW v25 or newer) pp: 0xA6 => Hybrid mode (supported in FW v35 or newer)
Absolute Position	Set	8x 01 06 02 1V WW 0Y 0Y 0Y 0Z 0Z 0Z 0Z FF	VV: Pan speed setting 0x01 (low speed) to 0x18 (high speed) WW: Tilt speed setting 0x01 (low speed) to 0x18 (high speed) YYYY: Pan Position 8A14 to 762C (CENTER 0000) ZZZZ: Tilt Position 468B to E898 (Image Flip: 0FF) (CENTER 0000) (Supported in FW v26 or above)
Auto zoom	On	8x 01 04 A0 01 FF	
	Off	8x 01 04 A0 03 FF	
Effective Tracking area	On	8x 01 04 A1 02 FF	
	Off	8x 01 04 A1 03 FF	
RTMP	On	8x 01 04 A2 02 FF	
	Off	8x 01 04 A2 03 FF	
Video mode	IP-Stream	8x 01 04 A3 02 FF	
	USB only	8x 01 04 A3 01 FF	
	NDI only	8x 01 04 A3 02 FF	
	Streaming only	8x 01 04 A3 03 FF	
Reboot	On	8x 01 04 A4 FF	
	Off	8x 01 04 A5 02 FF	
Preset Affects PTZ & Focus	On	8x 01 04 A5 03 FF	
	Off	8x 01 04 A5 04 FF	
Relative Zoom Ratio	On	8x 01 04 A6 02 FF	
	Off	8x 01 04 A6 03 FF	
Auto Tilt	On	8x 01 04 A7 02 FF	
	Off	8x 01 04 A7 03 FF	

Inquiry Command	Command Packet	Reply Packet	Comments
CAM_PoweringInq	8x 09 04 00 FF	y0 50 02 FF	On
		y0 50 03 FF	Off
		y0 50 00 FF	Auto
		y0 50 01 FF	In Door
CAM_WBModelInq	8x 09 04 35 FF	y0 50 02 FF	Out Door
		y0 50 03 FF	One Push WB
		y0 50 04 FF	ATW
		y0 50 05 FF	Manual
CAM_RGainInq	8x 09 04 43 FF	y0 50 00 00 0p 0q FF	pq: R Gain
CAM_BGainInq	8x 09 04 44 FF	y0 50 00 00 0p 0q FF	pq: B Gain
		y0 50 00 FF	Full Auto
		y0 50 03 FF	Manual
CAM_AEModelInq	8x 09 04 39 FF	y0 50 0A FF	Shutter Priority
		y0 50 0B FF	Iris Priority
		y0 50 00 FF	Bright
CAM_ShutterPosInq	8x 09 04 4A FF	y0 50 00 00 0p 0q FF	pq: Shutter Position
CAM_IrisPosInq	8x 09 04 4B FF	y0 50 00 00 0p 0q FF	pq: Iris Position
CAM_GainPosInq	8x 09 04 4C FF	y0 50 00 00 0p 0q FF	pq: Gain Position
CAM_BrightPosInq	8x 09 04 4D FF	y0 50 00 00 0p 0q FF	pq: Bright Position
CAM_ExpCompPosInq	8x 09 04 4E FF	y0 50 00 00 0p 0q FF	pq: ExpComp Position
CAM_FocusModelInq	8x 09 04 38 FF	y0 50 02 FF	Auto Focus
		y0 50 03 FF	Manual Focus
CAM_FocusPosInq	8x 09 04 48 FF	y0 50 0n 0n 0r 0s FF	pqrs: Focus Position
zoom_Pos_Inq	8x 09 04 47 FF	y0 50 0n 0n 0r 0s FF	pqrs: Zoom Position
PT_Pos_Inq	8x 09 06 12 FF	y0 80 0Y 0Y 0Y 0Z 0Z 0Z 0Z FF	YYYY: Pan Position 8A14 to 762C (CENTER 0000) ZZZZ: Tilt Position 468B to E898 (Image Flip: OFF) (CENTER 0000)
CAM_Preset Inq	8x 09 04 3F FF	y0 50 pp FF	Return the last preset number which has been operated pp:01-FF
CAM_Tracking status	8x 09 36 69 02 FF	y0 50 01 FF	On
		y0 50 00 FF	Off
		y0 50 01 FF	Presenter
CAM_Tracking_mode	8x 09 36 69 01 FF	y0 50 02 FF	Zone
		y0 50 03 FF	Hybrid
CAM_Tracking body size	8x 09 36 69 03 FF	y0 50 03 FF	Full body
		y0 50 02 FF	Upper body
CAM_OSD MENU on/off	8x 09 7E 04 76 01 FF	y0 50 02 FF	On
		y0 50 03 FF	Off
CAM_Tally	8x 09 7E 01 0A FF	y0 50 02 FF	On
		y0 50 03 FF	Off
CAM_WDR mode	8x 09 04 3D FF	y0 50 02 FF	On
		y0 50 03 FF	Off
CAM_BLC mode	8x 09 04 33 FF	y0 50 02 FF	On
		y0 50 03 FF	Off
CAM_Live Freeze	8x 09 04 62 01 FF	y0 50 02 FF	Freeze On
		y0 50 03 FF	Freeze Off
CAM_Preset Freeze	8x 09 04 62 02 FF	y0 50 02 FF	Preset Freeze On
		y0 50 03 FF	Preset Freeze Off
Firmware version	8x 09 36 69 04 FF	y0 50 0p 0q 0r 0s 0t 0u 0v 0w FF	fw ver: p.q.rstu.vw

Visca over IP Settings

VISCA over IP

PORT

Internet protocol	IPv4
Transport protocol	UDP
Port address	52381

FORMAT

	byte 0	byte 1	byte 2	byte 3	byte 4	byte 5	byte 6	byte 7	byte8 ~~~~	byte23	
func	Payload type		Payload length		Sequence number			Payload (1 to 16 bytes)			
data	Value1	Value2	1~16 (0x0001~0x0010)		0X00000000 ~ 0XFFFFFFF			VISCA Packet (see page VISCA)			

Payload type

Name	Value1	Value2	Description
VISCA command	0x01	0x00	Stores the VISCA command.
VISCA inquiry	0x01	0x10	Stores the VISCA inquiry.
VISCA reply	0x01	0x11	Stores the reply for the VISCA command or VISCA inquiry

Sequence number

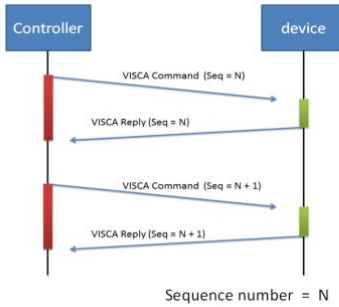

CGI Command

CGI List for Video Transmission					
CGI item name	URL	Command	Parameter Name	Parameter value	Description
Get JPEG	/anapsbot				1280x720.jpg
Get RTSP stream	rtsp://ip/live_011				
CGI List for Camera Control					
CGI item name	URL	Command	Parameter Name	Parameter value	Description
up start	/cgi-bin?SetPzf=#	1,0,1&(random)			
up end	/cgi-bin?SetPzf=#	1,0,2&(random)			
down start	/cgi-bin?SetPzf=#	1,1,1&(random)			
down end	/cgi-bin?SetPzf=#	1,1,2&(random)			
left start	/cgi-bin?SetPzf=#	0,1,1&(random)			
left end	/cgi-bin?SetPzf=#	0,1,2&(random)			
right start	/cgi-bin?SetPzf=#	0,0,1&(random)			
right end	/cgi-bin?SetPzf=#	0,0,2&(random)			
zoom_in start	/cgi-bin?SetPzf=#	2,0,1&(random)			
zoom_in end	/cgi-bin?SetPzf=#	2,0,2&(random)			
zoom_out start	/cgi-bin?SetPzf=#	2,1,1&(random)			
zoom_out end	/cgi-bin?SetPzf=#	2,1,2&(random)			
set preset	/cgi-bin?ActIPreset=#	1,N&(random)			N : position
load preset	/cgi-bin?ActIPreset=#	0,N&(random)			N : position
CGI List for Various Settings					
exposure value	/cgi-bin?Set=#	img_expo_3,N&(random)	value	1 - 9	N : value
saturation	/cgi-bin?Set=#	img_saturation_3,N&(random)	value	0 - 10	N : value
contrast	/cgi-bin?Set=#	img_contrast_3,N&(random)	value	0 - 4	N : value
Tracking on:	/cgi-bin?Set=#	trk_tracking_on,3,1			
Tracking off:	/cgi-bin?Set=#	trk_tracking_on,3,0			
Reboot	GET(Basic Authentication)	/cgi-bin?OnePush=#			
Factory Reset	GET(Basic Authentication)	/cgi-bin?OnePush=#			
Mode Presenter		/cgi-bin?Set=trk_mode,3,1&X	value	random number	X : value
Mode Zone		/cgi-bin?Set=trk_mode,3,2&X	value	random number	X : value
Mode Hybrid		/cgi-bin?Set=trk_mode,3,3&X			
Mode Get	GET(Basic Authentication)	/cgi-bin?Get=trk_mode,3&_#X	value	random number	X : value
	- Reply	Presenter trk_mode_3=1 Zone trk_mode_3=2 Hybrid trk_mode_3=3			
Click Track ON	GET(Basic Authentication)	/cgi-bin?Set=trk_update_detect,3,1			
Click Track OFF	GET(Basic Authentication)	/cgi-bin?Set=trk_update_detect,3,0			
Click Track Get detect zone (Humanoid outlines) number	GET(Basic Authentication)	/cgi-bin?Get=trk_detect_num,3			Need to be sent along with Click Track ON command
	- Reply	"trk_detect_num,3=X/n/n"	X: The amount of humanoid outlines, maximum: 50		
Click Track Get detect zone (Humanoid outlines) info	GET(Basic Authentication)	/cgi-bin?GetTrackingDetectZone=#X			
	- Reply	"focus:~1~nzone[00],00,119,720,960~nzone[01]-1502615204,-1366225632,01,-1366223544"	focus - The number of humanoid outline being tracked. zone[NN]:x,y,w,h - based on 1080P resolution	The upper left corner of the screen is the coordinate reference (0,0), x-coordinate~coordinate/w~width/h height, based on the upper left corner of the humanoid outline. The number following indicates the number of the tracked person, for example, '-1' means that no one is being tracked. If one of the three is being tracked, one of 0, 1 and 2 will appear after the 'focus'.	
Click Track Set target zone	GET(Basic Authentication)	/cgi-bin?Set=trk_assign_zone,3,X	X:	The number of the human outlines	
	- Reply	http response: ok			
	GET(Basic Authentication)	/cgi-bin?SetString=TrackingFocusZone.[x,y,w,h]			
- Reply	http response: ok				
Tracking On/Off Get	GET(Basic Authentication)	/cgi-bin?Get=trk_tracking_on,3&_#X		random number	X : value
	- Reply	On trk_tracking_on,3=1 Off trk_tracking_on,3=0"			
RTMP Start streaming	/cgi-bin?Set=#	vid_rtmp_enable,3,1			
RTMP Stop streaming	/cgi-bin?Set=#	vid_rtmp_enable,3,0			