



Owner's Manual

DLP PROJECTOR

Please read the safety information carefully before using the product.

PF85U

www.lg.com

LICENSE

Supported licenses may differ by model. For more information about licenses, visit www.lg.com.



Manufactured under license from Dolby Laboratories. “Dolby” and the double-D symbol are trademarks of Dolby Laboratories.



ABOUT DIVX VIDEO: DivX® is a digital video format created by DivX, LLC, a subsidiary of Rovi Corporation. This is an official DivX Certified® device that has passed rigorous testing to verify that it plays DivX video. Visit divx.com for more information and software tools to convert your files into DivX videos.

ABOUT DIVX VIDEO-ON-DEMAND: This DivX Certified® device must be registered in order to play purchased DivX Video-on-Demand (VOD) movies. To obtain your registration code, locate the DivX VOD section in your device setup menu. Go to vod.divx.com for more information on how to complete your registration. DivX Certified® to play DivX® video up to HD 1080p, including premium content.

DivX®, DivX Certified® and associated logos are trademarks of Rovi Corporation or its subsidiaries and are used under license.

Covered by one or more of the following U.S. patents: 7,295,673; 7,460,668; 7,515,710; 7,519,274



The terms HDMI and HDMI High-Definition Multimedia Interface, and the HDMI logo are trademarks or registered trademarks of HDMI Licensing LLC in the United States and other countries.



For DTS patents, see <http://patents.dts.com>. Manufactured under license from DTS Licensing Limited. DTS, the Symbol, & DTS and the Symbol together are registered trademarks, and DTS 2.0+Digital Out is a trademark of DTS, Inc. © DTS, Inc. All Rights Reserved.

This device meets the EMC requirements for home appliances (Class B) and is intended for home usage. This device can be used in all regions.



NOTE

- Image shown may differ from your projector.
- Your projector's OSD (On Screen Display) may differ slightly from that shown in this manual.

SAFETY INSTRUCTIONS

Please take note of the safety instructions to prevent any potential accident or misuse of the projector.

- Safety precautions are given in two forms, i.e. **Warning** and **Caution** as detailed below.

 **WARNING** Failure to follow the instructions may cause serious injury and even death.

 **CAUTION** Failure to follow the instructions may cause personal injury or product damage.

- Read the owner's manual carefully and keep it on hand.



WARNING/CAUTION

**RISK OF ELECTRIC SHOCK
DO NOT OPEN**



The lightning flash with arrowhead symbol, within an equilateral triangle, is intended to alert the user to the presence of uninsulated dangerous voltage within the product's enclosure that may be of sufficient magnitude to constitute a risk of electric shock to persons.

The exclamation point within an equilateral triangle is intended to alert the user to the presence of important operating and maintenance (servicing) instructions in the literature accompanying the appliance.

WARNING/CAUTION

- TO REDUCE THE RISK OF FIRE AND ELECTRIC SHOCK, DO NOT EXPOSE THIS PRODUCT TO RAIN OR MOISTURE.

Read these instructions.

Keep these instructions.

Heed all warnings.

Follow all instructions.

Indoor Installation

WARNING

- Do not use the projector outside and do not expose the product to any humidity or water.
 - Since the product is not waterproof, this may result in a fire or electric shock.
- Do not place the projector in direct sunlight or near heat sources such as radiators, fires, stoves, etc.
 - This may result in fire.
- Do not place flammable materials such as aerosols near the projector.
 - This may result in fire.
- Do not allow children to cling to or climb up to the projector.
 - This may cause the projector to fall, causing injury or death.
- Do not install the product in a place with no ventilation (e.g., on a bookshelf or in a closet) or on a carpet or cushion.
 - This may result in fire due to the increase in internal temperature.

- Do not place the product close to sources of steam, oil or oil mist, such as humidifiers and kitchen counters.
 - Failure to do so may result in fire, electric shock, or corrosion.
- Do not install the product onto a wall or ceiling that is close to sources of oil or oil mist.
 - The product may be damaged and fall, resulting in serious injury.
- Do not place the projector where it might be exposed to dust.
 - This may result in fire.
- Do not use the projector in a damp place such as a bathroom where it is likely to get wet.
 - This may result in fire or electric shock.
- Do not allow a tablecloth or curtain to block the air vent.
 - This may result in fire due to the increase in the internal temperature.
- Ensure good ventilation around the projector. The distance between the projector and the wall should be at least 30 cm (11.8 inches).
 - This will prevent fire due to the increase in the internal temperature.

CAUTION

- When placing the projector on a table or shelf, be careful not to put it near the edge.
 - **The projector could fall due to balance problems, which may cause personal injury or damage to the product.** Make sure to use the projector cabinet or stand that fits the projector.
- When moving the projector, make sure to switch it off and remove the power plug and cords.
 - The power cord may be damaged, resulting in fire or electric shock.
- Do not place the projector on an unstable or vibrating surface such as a wobbly shelf or a slope.
 - It may fall and cause injury.
- Be careful not to tip the projector over when connecting external devices to the projector.
 - This may cause personal injury or damage to the projector.

Power

WARNING

- The grounding wire should be connected.
 - Ensure that you connect the grounding cable to avoid electric shock. If it is not possible to ground the unit, have a qualified electrician install a separate circuit breaker.
 - Do not try to ground the projector by connecting it to telephone wires, lightning rods or gas pipes.
- The power plug should be inserted fully into the power outlet.
 - An unstable connection may cause a fire.
- Do not place heavy objects on the power cord.
 - This may result in fire or electric shock.
- Never touch the power plug with wet hands.
 - This may result in electric shock.
- Do not plug too many devices into one multi-power outlet.
 - This may result in fire due to the power outlet overheating.
- Prevent dust from collecting on the power plug pins or outlet.
 - This may result in fire.
- To turn off the main power, remove the power plug, which should be positioned so it is easy to access for operation.

⚠ CAUTION

- Hold the plug firmly when unplugging.
 - A damaged wire may create a fire hazard.
- Ensure the power cord and plug are not damaged, modified, severely bent, twisted, pulled, sandwiched or hot. Do not use the product if the power outlet is loose.
 - This may result in fire or electric shock.
- Keep the power cord away from heating devices.
 - The wire's sheath may melt, which may result in fire or electric shock.
- Place the projector where people will not trip over or step on the power cord to protect the power cord and plug from any damage.
 - This may result in fire or electric shock.
- Do not turn the projector on or off by plugging in the power plug or unplugging it from the power outlet. (Do not use the power plug as a switch.)
 - This may result in electric shock or damage to the product.
- Do not insert a conductor into the other side of the wall outlet while the power plug is inserted into the wall outlet.

In addition, do not touch the power plug immediately after it is disconnected from the wall outlet.

 - This may result in electric shock.
- Only use the official power cord provided by LG Electronics. Do not use other power cords.
 - This may result in fire or electric shock.

When In Use**⚠ WARNING**

- Do not place anything containing liquid on top of the projector such as a vase, flower pot, cup, cosmetics, or medicine; or ornaments, candles, etc.
 - This may result in fire or electric shock, or cause injury due to falling.
- In the event that there is a heavy impact or the cabinet is damaged, switch it off, unplug it from the power outlet and contact an authorized service center.
 - This may result in electric shock.
- Do not insert pieces of metal such as coins, hairpins or metal debris, nor flammable materials such as paper or matches into the projector.
 - This is to prevent electric shock or fire.
- In the event that liquid or a foreign object falls into the projector, switch it off and unplug it from the power outlet and contact our service center.
 - This may result in fire or electric shock.
- Make sure that a child does not swallow the batteries when you replace the old remote control batteries with new ones. Keep batteries out of reach of children.
 - If a child swallows a battery, consult a doctor immediately.
- Never open any cover on the projector.
 - There is a high risk of electric shock.
- Do not look directly into the lens when the projector is in use.
 - The bright light may damage your eyes.
- When the lamp is on or has just been turned off, avoid touching the air vent or lamp, because these will be very hot.

- If there is a gas leak in the room with the projector, do not touch the projector or power outlet. Open the windows for ventilation.
 - Sparks may cause fire or burns.
- Unplug the power cord from the outlet during a lightning storm.
 - This will prevent shock or damage to the projector.
- Do not use the projector near electronic devices that generate a strong magnetic field.
- Do not put the plastic package used to pack the projector around your head.
 - This may cause suffocation.
- Do not keep your hand on the projector for a long time when it is running.
- When you play a game by connecting a game console to a projector, it is recommended that you maintain a distance of more than four times the diagonal length of the screen.
 - Make sure that the connecting cable is long enough. Otherwise, the product may fall causing personal injury or damage to the product.
- Do not place the projector or its remote control with battery in an extremely high temperature environment.
 - This may result in fire.

⚠ CAUTION

- Do not place heavy objects on the projector.
 - It may fall down and cause personal injury.
- Be careful not to allow any impact to the lens during transport.
- Do not touch the lens of the projector.
 - The lens may be damaged.
- Do not use any sharp tools on the projector such as a knife or hammer, because this may damage the casing.
- In the event that no image appears on the screen or no sound is heard, stop using the projector. Switch off the projector, unplug it from the power outlet and contact our service center.
 - This may result in fire or electric shock.
- Do not drop anything onto the projector or allow anything to bang into the projector.
 - This may cause damage to the projector or personal injury.
- It is recommended that you maintain a distance of at least 5-7 times the diagonal length of the screen.
 - If you watch the screen at a close distance for a long time, your eye sight may become worse.
- Do not block the light beam emitted from the projector using a book or other object.
 - Lengthy exposure to the projector beam may result in fire. In addition, the lens may be overheated and damaged by the reflected heat. Disable the AV function to stop projection temporarily or turn off the power.
- Do not start the projector with the volume turned up high.
 - High volume may damage hearing.

Cleaning

WARNING

- Do not spray the projector with water when cleaning. Make sure water does not flow into the projector.
 - This may result in fire or electric shock.
- When there is smoke or a strange smell coming out from the projector or a foreign object falls into the projector, please switch it off and unplug it from the power outlet and contact our service center.
 - Otherwise, this may result in fire or electric shock.
- Use air spray, a soft cloth or a cotton swab moistened with a lens cleaning chemical or alcohol to remove dust or stains on the front projection lens.

CAUTION

- Contact your seller or our service center once a year to clean the internal parts of the projector.
 - If you do not clean the projector for a long period of time, dust will accumulate, which may result in fire or damage to the projector.
- When cleaning plastic parts such as the projector case, unplug the power first and wipe with a soft cloth. Do not spray with water or wipe with a wet cloth. Never use glass cleaner, automobile or industrial shiner, abrasives, wax, benzene, or alcohol as these can damage the projector.
 - This can result in fire, electric shock or cause damage to the product (deformation and corrosion).
- Remove the plug from the outlet before cleaning the product.
 - Otherwise, this may result in electric shock.

Others

WARNING

- When you go out, place the projector out of reach of animals, and remove the power plug from the wall outlet.
 - Using a damaged power cord may result in short circuit or fire.
- Do not use the projector near high-precision electronic devices or those that transmit weak radio signals.
 - This may affect the operation of the product, causing an accident.
- Only a qualified technician can disassemble or modify the projector. For diagnosis, adjustment, or repair, contact your seller or our service center.
 - This may result in fire or electric shock.
- Do not stare directly into lens when in operation, eye damage can occur.
- No user serviceable parts inside unit. High voltage parts can cause shock and even electrocution.
- Proper ventilation required, do not block airflow around unit. Doing so can cause injury and internal overheating.
- To prevent damage to lamp, unit must remain plugged in for approximately 3 minutes after power down to allow for proper cool down (not applicable on LED models).
- Do not touch the lens; doing so can result in burns or damage to lens. Lens and unit may be HOT during and immediately after use. Use caution when handling unit, allowing for proper cool down.
- Only use a grounded electrical outlet.

- Do not insert anything into or cover up the exhaust vents.
 - This may result in fire or electric shock.
- Follow all maintenance guidelines for optimal use; service only at an authorized service center.
- Lamp contains mercury and as such must be disposed of according to local, state and federal laws (not applicable on LED models).

CAUTION

- Do not mix new batteries with old ones.
 - Burst or leaking batteries may result in damage or injury.
- Be sure to unplug if the projector is not to be used for a long period.
 - Accumulated dust may result in fire or electric shock due to overheating, ignition, or poor insulation.
- Only use the specified type of battery.
 - Burst or leaking batteries may result in damage or injury.
- Do not charge the battery using any devices other than the one provided with the product.
 - This may result in damage to the battery or fire.
- Dispose of used batteries properly.
 - This may result in explosion or fire. The correct method of disposal may vary depending on your country or region. Dispose of the battery pack as instructed.
- Do not throw or disassemble the battery.
 - This may result in fire or explosion due to damage to the battery.
- Always use batteries approved and certified by LG Electronics.
 - This will prevent damage or fire.

- Store batteries away from metallic objects, such as keys and paper clips.
 - Excess current may cause a rapid increase in temperature, resulting in fire or burns.
- Do not store the batteries near any heat source, such as a heater.
 - This may result in fire or damage to the product.
- Do not store batteries at temperatures higher than 60 °C (140° F) or in high humidity.
 - This may result in explosion or fire.
- Keep the batteries and remote out of reach of children.
 - This will prevent personal injury or damage to the product.
- Make sure that the battery is installed correctly.
 - This prevent explosion or fire.
- The battery contains lithium-ion, so it must be handled with care.
 - This may result in explosion or fire.
- Make sure you use the same type of batteries for replacement.
- Incorrect battery replacement may cause fire.

Risk Group 2

CAUTION Possibly hazardous optical radiation emitted from this product. Do not stare at operating lamp. It could be harmful to the eye.

ANTENNA

Outdoor Antenna Grounding

- If an outdoor antenna is installed, follow the precautions below. An outdoor antenna system should not be located in the vicinity of overhead power lines or other electric light or power circuits, or where it can come in contact with such power lines or circuits as death or serious injury can occur. Be sure the antenna system is grounded so as to provide some protection against voltage surges and built-up static charges. Section 810 of the National Electrical Code (NEC) in the U.S.A. provides information with respect to proper grounding of the mast and supporting structure, grounding of the lead-in wire to an antenna discharge unit, size of grounding conductors, location of antenna discharge unit, connection to grounding electrodes and requirements for the grounding electrode.

Antenna grounding according to the National Electrical Code, ANSI/NFPA 70

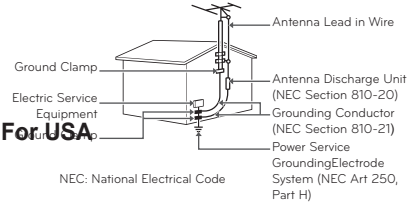

NOTE TO CABLE/TV INSTALLER

This reminder is provided to call the CATV system installer's attention to Article 820 - 40 of the National Electric Code (U.S.A.). The code provides guidelines for proper grounding and, in particular, specifies that the cable ground shall be connected to the grounding system of the building, as close to the point of the cable entry as practical.

FCC NOTICE**Federal Communications Commission (FCC) Statement**

You are cautioned that changes or modifications not expressly approved by the part responsible for compliance could void the user's authority to operate the equipment.

This equipment has been tested and found to comply with the limits for a Class B digital device, pursuant to part 15 of the FCC rules. These limits are designed to provide reasonable protection against harmful interference in a residential installation. This equipment generates, uses and can radiate radio frequency energy and, if not installed and used in accordance with the instructions, may cause harmful interference to radio communications. However, there is no guarantee that interference will not occur in a particular installation. If this equipment does cause harmful interference to radio or television reception, which can be determined by turning the equipment off and on, the user is encouraged to try to correct the interference by one or more of the following measures:

- Reorient or relocate the receiving antenna.
- Increase the separation between the equipment and receiver.
- Connect the equipment into an outlet on a circuit different from that to which the receiver is connected.
- Consult the dealer or an experienced radio/projector technician for help.

This device complies with Part 15 of the FCC Rules. Operation is subject to the following two conditions:

- 1) This device may not cause harmful interference, and
- 2) This device must accept any interference received, including interference that may cause undesired operation of the device of the device.

FCC Caution

Any changes or modifications not expressly approved by the party responsible for compliance could void the user's authority to operate this equipment and for indoor use only, use outdoors or in other modes not covered by this manual may violate the FCC regulation and violate the user authority to use the product.

Specially, within the 5.15-5.25 GHz band, U-NII device is restricted to indoor operations to reduce any potential for harmful interference to co-channel MSS operations.

FCC RF Radiation Exposure**Statement:**

This equipment complies with FCC radiation exposure limits set forth for an uncontrolled environment. This equipment should be installed and operated with minimum distance 20 cm (7.8 inches) between the radiator and your body. End users must follow the specific operating instructions for satisfying RF exposure compliance.

IC (CANADA)**Industry Canada Statement:**

This device complies with RSS-210 of the Industry Canada Rules. Operation is subject to the following two conditions:

- 1) this device may not cause interference and
- 2) this device must accept any interference, including interference that may cause undesired operation of the device.

Avis d'Industrie Canada :

Cet appareil est conforme à la norme CNR-210 des règlements d'Industrie Canada. Son fonctionnement est sujet aux deux conditions suivantes :

- 1) Cet appareil ne doit pas provoquer d'interférences et
- 2) Cet appareil doit accepter toutes les interférences, y compris celles pouvant entraîner son dysfonctionnement.

IC Radiation Exposure Statement:

This equipment complies with IC radiation exposure limits set forth for an uncontrolled environment.

NOTE: THE MANUFACTURER IS NOT RESPONSIBLE FOR ANY RADIO OR TV INTERFERENCE CAUSED BY UNAUTHORIZED MODIFICATIONS TO THIS EQUIPMENT. SUCH MODIFICATIONS COULD VOID THE USER'S AUTHORITY TO OPERATE THE EQUIPMENT.

Avis d'Industrie Canada sur l'exposition aux rayonnements

Cet appareil est conforme aux limites d'exposition aux rayonnements d'Industrie Canada pour un environnement non contrôlé.

REMARQUE : LE FABRICANT N'EST PAS RESPONSABLE DES INTERFÉRENCES RADIOÉLECTRIQUES CAUSÉES PAR DES MODIFICATIONS NON AUTORISÉES APPORTÉES À CET APPAREIL. DE TELLES MODIFICATIONS POURRAIT ANNULER L'AUTORISATION ACCORDÉE À L'UTILISATEUR DE FAIRE FONCTIONNER L'APPAREIL.

CONTENTS

LICENSE	2	Additional Options	34
SAFETY INSTRUCTIONS	3	- Adjusting Aspect Ratio	34
PREPARATION	15	- Using the Keystone Function	34
Accessories	15	- Changing Input Device	35
Optional Extras	16	- To Use SIMPLINK	36
Parts and Components	17	Using the Quick Menu	37
- Front	17	To Set Sound	38
- Back	18	- To Set Sound Output	38
Installation	19	- To Connect and Use a Bluetooth headset	40
- Installation Precautions	19	- Using the Multi Audio	40
- Projection Distance per Screen Size	20	ENTERTAINMENT	41
- How to Install the Projector On a Tripod	21	To Use Smart Features	41
- Kensington Security System	21	- To Use Home Screen	41
REMOTE CONTROL	22	- To Use MY APPS	42
MAGIC REMOTE CONTROL	24	- To Edit Items in MY APPS	42
- To Register the Magic Remote Control	26	To Connect Network	43
- To Re-register the Magic Remote Control	26	- One-click Network Connection	43
- Using the Magic Remote Control	27	- To Connect to a Network Through Set Expert	43
USING THE PROJECTOR	28	- To Use the Wi-Fi Direct Function	44
Connecting to an Antenna or Cable	28	- To Use the Miracast™/Intel's WiDi Function	44
Watching Projector	29	- Tips for Network Settings	45
- Initial Setup	29	Tag On	46
- Focus and Position of the Screen Image	32	- What is Tag On?	46
- Watching With the Projector	32	- To Start Tag On For the First Time	46
To Set Channel	33	- To use the Tag On	47
- To View Program Information	33	SMARTSHARE	48
- To set Favorite Channels	33	Before Using	48
- To use Favorite	33	- Connecting a USB Device	48
		- Removing a USB Device	48
		To use SmartShare™	50
		- Watching the Videos	51
		- Viewing the Photos	53
		- Listening to Music	54

- Viewing Files	55	- To Use Screen Remote	79
- To Set SmartShare™ Related Functions	56	- To Control a Device Connected to the Projector Using the Screen Remote	79
To Use the LG Cloud	59	To Use the Universal Control function	80
- What is the LG Cloud?	59	To Control a Projector Using a Smartphone	81
- To Use the LG Cloud	60	To Use a USB Input Device On a Projector	82
To Connect DLNA	61	- To Use a USB Wired/wireless Mouse	82
- To Connect a DLNA-Authenticated Smartphone	61	- To Use a USB Wired/wireless Keyboard	82
- To Connect DLNA DMR (Digital Media Renderer)	61		
- To Connect DLNA DMP (Digital Media Player)	62	CUSTOMIZING SETTINGS	83
- SmartShare™ PC SW Installing and Setting	63	SETTINGS	83
- In Case of a DLNA Malfunction	64	PICTURE Settings	84
To Use A Premium Service	65	SOUND Settings	88
- To Use Paid Content	65	CHANNEL Settings	91
- To Reset Premium	66	TIME Settings	92
To use LG Smart World	67	LOCK Settings	93
To Use Search Function	68	OPTION Settings	95
To Use the Voice Recognition Function	68	NETWORK Settings	99
- Using this Function Through Search	68	SUPPORT	100
- Using this Function on the Internet	69		
To Use Voice Mate Function	70	CONNECTING DEVICES	101
- What Is Voice Mate?	70	Connecting to HD Receiver, DVD, or VCR Player, External Devices	102
- How to Use Voice Mate?	71	- HDMI Connection	102
- What Are Other Functions of Voice Mate?	71	- HDMI to DVI Connection	103
		- AV Connection	103
What Is On Now?	72	- Component Connection	104
- To Use On Now	72	Connecting a PC	104
To Use Internet	74	- HDMI Connection	104
Frequently Asked Questions for Smart Projector	75	- HDMI to DVI Connection	105
		Connecting a Laptop	106
USING ADVANCED FUNCTIONS	79	- HDMI Connection	106
To Use Screen Remote	79	Connecting to Headphones	107

Connecting a Digital Amp 108

Using the Mirroring Function of a Mobile Phone 109

- MHL Connection 109

MAINTENANCE 110

Cleaning 110

- Cleaning the Lens 110
- Cleaning the Projector Case 110

INFORMATION 111

To update projector software 111

Before reporting a problem, check the following: 112

- General 112
- Picture 112
- Sound 113
- PC connection problem 114
- Problems Replaying Movies in My Media 115

SPECIFICATIONS 116

PREPARATION

Accessories

Accessories included with the project are show below. The pictures may differ slightly from the actual product. Accessories are subject to change without prior notice. New accessories may be added or old ones removed.

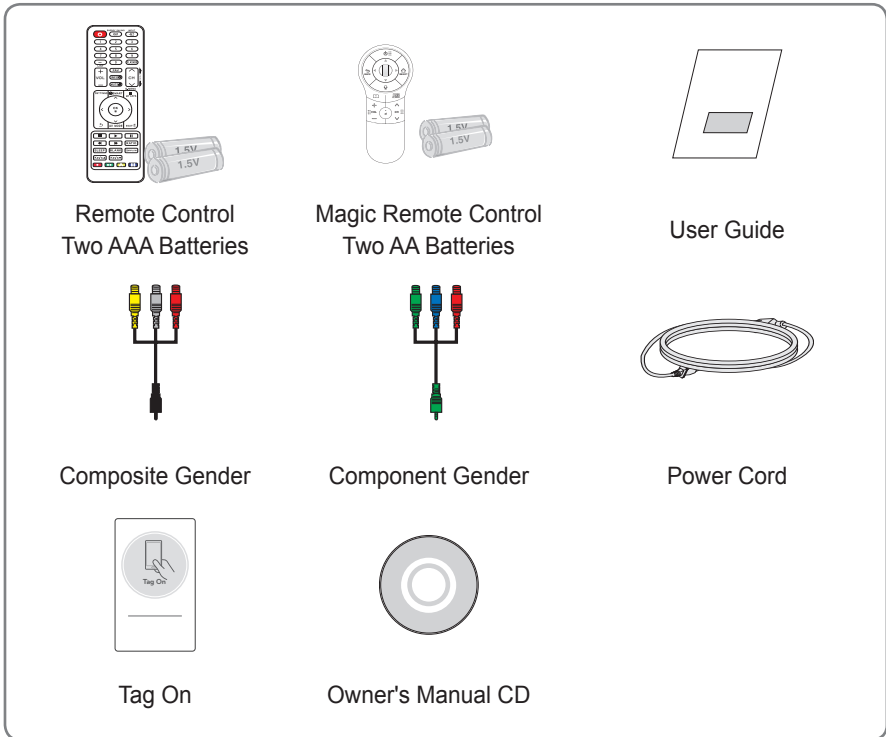

- When connecting an HDMI or USB cable, or connecting a USB flash drive to the HDMI or USB port, use a product that has a width of 18 mm or less and a height of 10 mm or less. If the USB cable or USB flash drive does not fit the USB ports of the projector, use an extension cable that supports USB 2.0.

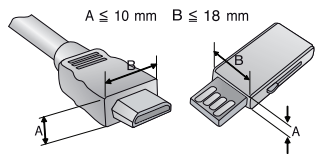

Optional Extras

To purchase optional accessories, visit an electronics store or online shopping site or contact the retail store where you purchased the product. Optional accessories are subject to change without prior notice.

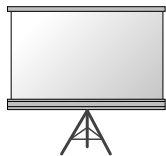

Projection Screen



Tripod



HDMI Cable



Video Cable



Audio Cable



RF Cable



Optical Cable

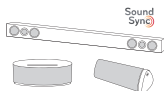

LG Audio Device



MHL Cable

Parts and Components

The projector is manufactured using high-precision technology. You may, however, see tiny black dots and/or bright colored dots (red, blue, or green) that continuously appear on the projector screen. This is a normal result of the manufacturing process and does not indicate a malfunction.

Front

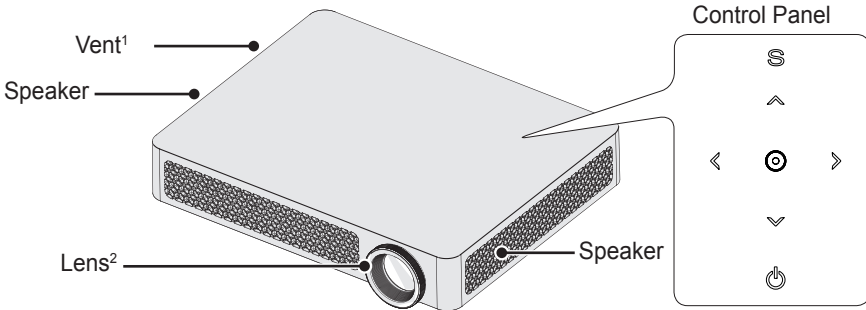

Button	Description
⏻ (POWER)	Turns the projector on or off.
Ⓢ (SMART)	Display or closes the Home menu.
⤴, ⤵ (CHANNEL)	Changes the channel or sets the features.
⏪, ⏩ (Volume)	Adjusts the volume level.
⤴, ⤵, ⏪, ⏩	Moves between menus and changes the settings.
Ⓞ (OK)	Shows the current mode and saves changes to the settings.

- 1 Due to the high temperature of vent area, do not get close to the vent area.
- 2 Do not touch the lens while using the projector. The lens may be damaged.

Back

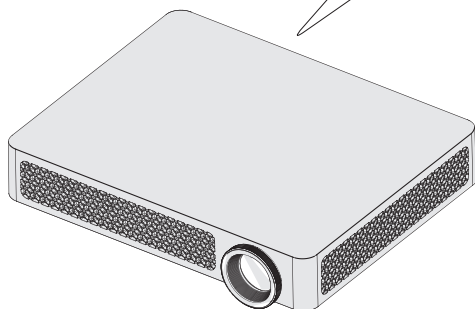
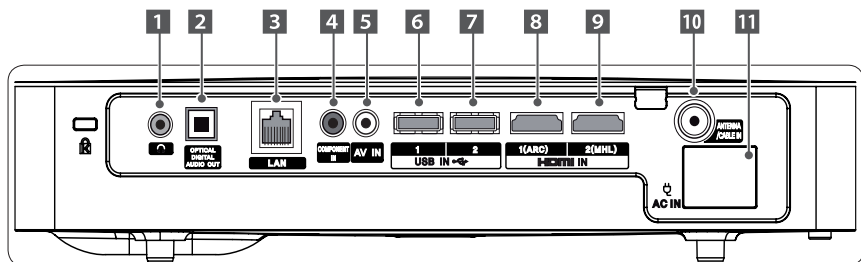

- | | | | |
|----------|--------------------------------|-----------|-----------------------|
| 1 | 🔊 (Headphone Port) | 7 | USB IN 2 Port |
| 2 | OPTICAL DIGITAL AUDIO OUT Port | 8 | HDMI IN 1(ARC) Port |
| 3 | LAN Port | 9 | HDMI IN 2(MHL) Port |
| 4 | COMPONENT IN Port | 10 | ANTENNA/CABLE IN Port |
| 5 | AV IN Port | 11 | AC IN Port |
| 6 | USB IN 1 Port | | |

Installation

Installation Precautions

- Place the projector in a well-ventilated environment.
 - To prevent internal heat build-up, install the projector in a well-ventilated place.
Do not place anything near the projector as this may block its air vents. If the air vents are blocked, the internal temperature will increase.

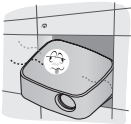

- Do not place the projector on a carpet or rug. If the vent is on the bottom, use the projector on a solid level surface and ensure the vent is not blocked.



- Be sure to prevent foreign objects such as paper debris from entering the projector.



- Leave enough distance (30 cm [11.8 inches] or more) around the projector.



- Do not place the projector in a hot, cool, or humid environment.
- Do not place the projector in a place where it will easily attract dust.
 - This may result in fire.
- Never open any cover on the projector. There is a high risk of electric shock.
- The projector is manufactured using high-precision technology. You may, however, see tiny black dots and/or bright colored dots (red, blue or green) that continuously appear on the projector screen. This is a normal result of the manufacturing process and does not indicate a malfunction.
- The remote control may not work in an environment where a lamp equipped with electronic ballasts or a three-wavelength fluorescent lamp is installed. Replace the lamp with an international standard lamp for the remote control to work normally.
- To adjust the angle of the projector, turn the adjustment legs to the left or right while pressing on the rubber part at the same time.

Projection Distance per Screen Size

- 1 Place the projector on a sturdy, level surface, together with the PC or audio/video source.
- 2 Place the projector an appropriate distance away from the screen. The distance between the projector and the screen determines the actual size of the image.
- 3 Position the projector so that the lens is at a right angle to the screen. If the projector is not at a right angle, the projected image will look distorted. To correct the distortion, use the Keystone function. (see page 34)
- 4 Connect the power cord of the projector and the connected device to the wall outlet.

Ratio of upward projection: 100 %

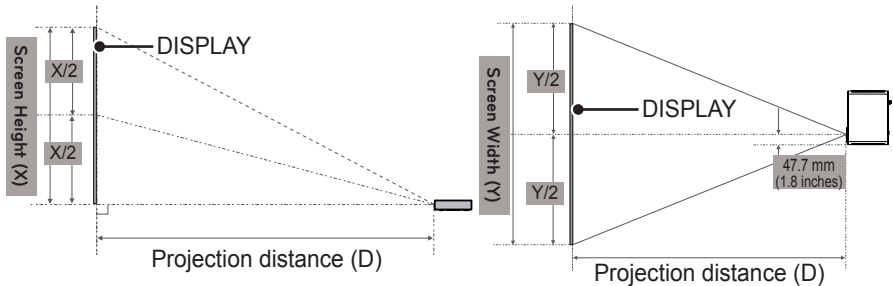

16:9 Ratio							
Screen Size (mm)	Screen Size (inch)	Screen Width (Y) (mm)	Screen Width (Y) (inch)	Screen Height (X) (mm)	Screen Height (X) (inch)	Projection Distance (D) (mm)	Projection Distance (D) (inch)
508	20	443	17.4	249	9.8	621	24.4
635	25	553	21.7	311	12.2	776	30.5
762	30	664	26.1	374	14.7	932	36.6
889	35	775	30.5	436	17.1	1087	42.7
1016	40	886	34.8	498	19.6	1242	48.8
1143	45	996	39.2	560	22	1397	55
1270	50	1107	43.5	623	24.5	1553	61.1
1397	55	1218	47.9	685	26.9	1708	67.2
1524	60	1328	52.2	747	29.4	1863	73.3
1651	65	1439	56.6	809	31.8	2018	79.4
1778	70	1550	61	872	34.3	2174	85.5
1905	75	1660	65.3	934	36.7	2329	91.6
2032	80	1771	69.7	996	39.2	2484	97.7
2159	85	1882	74	1058	41.6	2639	103.8
2286	90	1992	78.4	1121	44.1	2795	110
2413	95	2103	82.7	1183	46.5	2950	116.1
2540	100	2214	87.1	1245	49	3105	122.2
2667	105	2324	91.4	1308	51.4	3260	128.3
2794	110	2435	95.8	1370	53.9	3416	134.4
2921	115	2546	100.2	1432	56.3	3571	140.5
3048	120	2657	104.6	1494	58.8	3726	146.6

How to Install the Projector On a Tripod

- You can install this projector using a camera tripod.
As shown below, you can mount the projector instead of a camera on the tripod.
- When stabilizing the tripod, we recommend using a locking bolt of standard size 4.5 mm (0.1 inches) or less. The maximum size allowed for the locking bolt is 5.5 mm (0.2 inches).
(If it is longer than the maximum allowed size, it may damage the projector.)

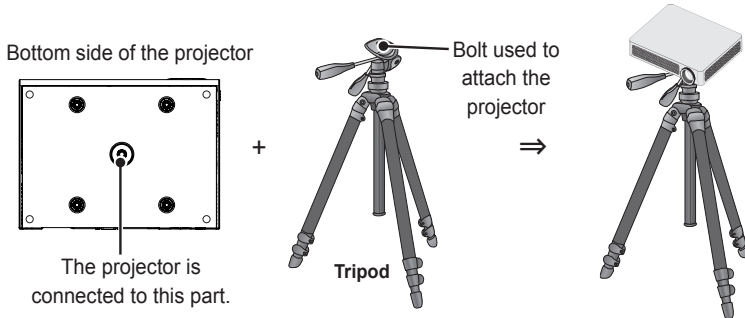

CAUTION

- If you are using a tripod, be careful not to apply external force to the tripod. Doing so may damage the projector.
- Do not place the tripod on an unstable surface.
- Be sure to use a tripod with a maximum load capacity of 3 kg or more.
- To use the projector safely, position the tripod legs so that they are as wide and stable as possible and be sure to securely attach the projector to the tripod.

Kensington Security System

- This projector has a Kensington Security Standard connector. Connect a Kensington Security System cable as shown below.
- For more information on installation and use of the Kensington Security System, refer to the user's guide provided with the Kensington Security System.
- The Kensington Security System is an optional accessory.
- What is Kensington? Kensington is a company that provides security systems for laptops and other electronic devices. Website: <http://www.kensington.com>

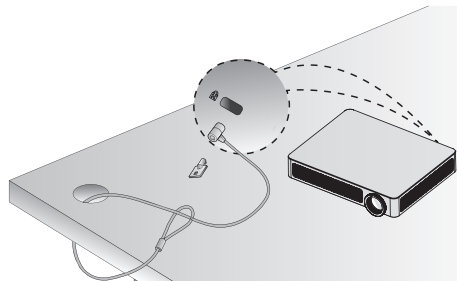

REMOTE CONTROL

Open the lid at the back of the remote control and insert the batteries as described in the \oplus \ominus instructions. Use new batteries and do not mix regular or rechargeable batteries. (1.5 V AAA)

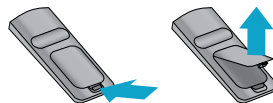

CAUTION

- Do not mix new batteries with old ones.

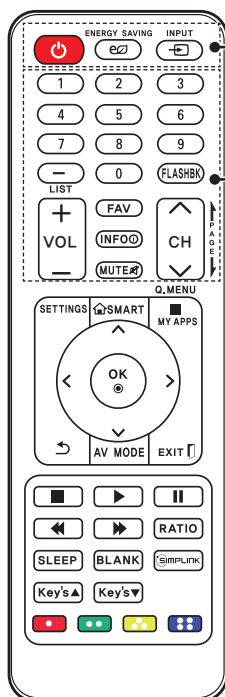

POWER

Turns the projector on or off.

ENERGY SAVING

Adjusts the screen brightness.

INPUT

Changes the input source.

Number buttons

Enters a number.

- (dash)

Enters a channel number, such as 2-1 or 2-2.

LIST

Displays the channel list.

FLASHBK

Displays the channel you were watching previously.

VOL +, -

Adjusts the volume level.

FAV

Shows favorite channels.

INFO ⓘ

Displays the information of a program or screen.

MUTE ⓧ

Mutes the sound of the projector.

CH ^, v

Changes the TV channel.

PAGE ↵/↴

Moves to the previous/next page.

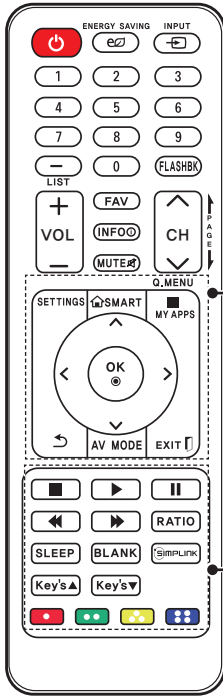

SETTINGS

Displays or closes the Settings menu.

SMART

Displays the Home menu.

MY APPS/ Q.MENU

MY APPS: Displays the list of my apps.

Q.MENU: Changes the settings easily.

Up/Down/Left/Right buttons

Switches between menu functions.

OK

Shows the current mode and saves changes to the settings.

Returns to the previous screen.

AV MODE

Selects AV mode for the genre of the program being watched.

EXIT

Exits the menu.

Playback control buttons

Controls the playback of multimedia content on the SmartShare™.

RATIO

Resizes the picture.

SLEEP

Sets the sleep timer.

BLANK

Displays the empty screen for a while.

SIMPLINK

Allows you to use the SIMPLINK function.

Key's ,

Adjusts the Keystone function.

Color buttons

Sets detailed settings or gesture for each menu.



NOTE

- When using the remote control, the optimal operation range is 6 meters (19.6 feet) or less (left/right) and within a 30 degree arc of the remote control IR receiver.
- If a cable is connected to the back port, the optimal operating range is 3 meters (9.8 feet) or less (left/right) and within a 30 degree arc of the remote control IR receiver.
- For seamless operation, do not block the IR receiver.
- When you carry the remote control in the portable bag, make sure that the buttons on the remote control are not pressed by the projector, cables, documents or any other accessories in the bag. Otherwise, it may significantly reduce the battery life.

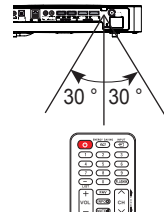

MAGIC REMOTE CONTROL

If the **battery low** message appears while using the projector, replace the batteries.

As shown in the figure, press the top of the battery cover and slide it down the cover. Insert two new and identical batteries (1.5 V, AA type) with + and - poles pointing in the correct direction in the remote control.

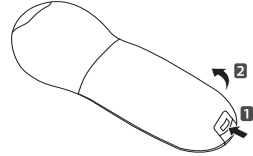

CAUTION

- Do not mix new batteries with old ones.

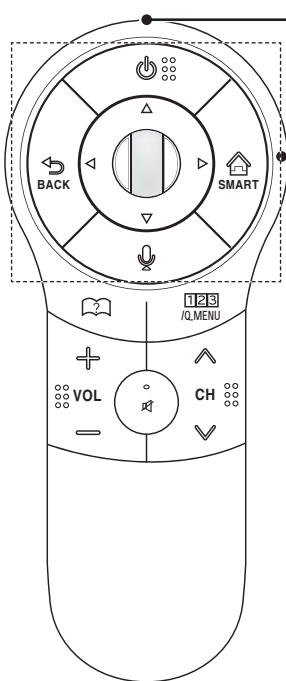

Pointer Signal Transmitter

(POWER)

Turns the projector on or off.

(Up/Down/Left/Right)

BACK

Press this button during menu selection to return to the previous step.

SMART

Displays the Home menu.

Wheel (OK)

Select a menu or option. If you press the button while the pointer is moving, the pointer disappears and the magic remote control operates as a normal remote control.

To display the pointer on the screen, shake the magic remote control to the left/right.

(Voice recognition)

Check the network connection before using the voice recognition function.

1. Press the voice recognition button.
2. Speak your request when the voice display bar on the left of the projector screen is activated. Use the magic remote control no further than 10 cm (3.9 inches) from your face. The voice search may fail if you speak too quickly or too slowly. The recognition rate may vary depending on the user's characteristics (voice volume, pronunciation, intonation, and speed) and the environment (noise and projector volume).

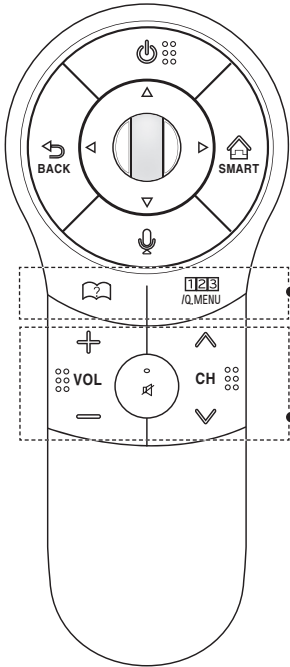

Opens the self-diagnosis window.



/Q.MENU

The universal remote is displayed. Allows you to change the projector settings easily.

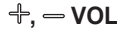

Adjusts the volume level.



Mutes the sound of the projector.



Changes the TV channel.



<p>1</p>	<p>Displayed when you press the Wheel (OK) button on the magic remote control. Check program information.</p>	<p>2</p>	<p>If you point and hold the pointer at the bottom left of the screen while watching Projector, the MY APPS icon is displayed. Clicking the icon displays the MY APPS menu.</p>
----------	--	----------	---







To Register the Magic Remote Control

To use the magic remote control, register it with your projector first.

- 1 Turn on the projector and wait for about 10 seconds and then press the  **Wheel (OK)** button while pointing the remote control at the projector.
- 2 The remote control is automatically registered and the registration completion message appears on the projector screen.

* If you failed to register the magic remote control, turn off the projector and try again.

To Re-register the Magic Remote Control

- 1 Press the **SMART**  and  **BACK** buttons together for about 5 seconds.
 - 2 Press the  **Wheel (OK)** button towards the projector to re-register the magic remote control.
- * Press the **SMART**  and  **BACK** button at the same time, for five seconds, to reset the Magic Remote Control.
- * Press the  **BACK** button while pointing the remote control at the projector for five seconds to reset and re-register it.

Using the Magic Remote Control



- 1** Shake the magic remote control lightly when there is no pointer displayed on the screen. A pointer will be displayed on the screen.
 - The pointer disappears if the remote control is not used for a certain period of time.
- 2** When you move the pointer signal transmitter up/down/left/right while pointing it toward the projector, the pointer moves.
 - If the pointer is not working properly, do not move the magic remote control for about 10 seconds, and then try again.
- 3** If you press the navigation button while moving the pointer on the screen, the pointer disappears, and the magic remote control works as a common remote control.
- 4** Use within an effective distance of 10 meters. (32.8 feet). Using the remote control from greater distances or when obstructions block the sight line may cause malfunctions.
- 5** Electronic devices nearby may cause communication interference. Devices such as microwave ovens and wireless LANs use the same frequency range (2.4 GHz) as the Magic Remote Control and may cause interference.
- 6** Take care not to bang it against other hard objects such as furniture or the floor.

USING THE PROJECTOR

Connecting to an Antenna or Cable

To watch TV using an indoor/outdoor antenna, connect a wall terminal and the antenna port of the Projector using an RF cable (75 Ω).

You can watch terrestrial or cable (analog, digital) TV. (The RF cable is sold separately.)

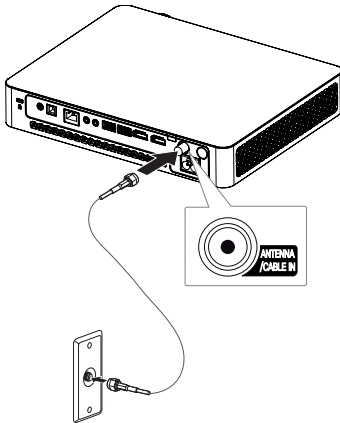

! NOTE

- Make sure not to bend the copper wire of the RF cable (75 Ω). Turn the input jack to the right to fasten it.

Copper wire

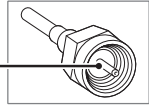

- Ensure you use a standard coaxial cable (75 Ω , sold separately) when connecting to the projector input.
- For better image quality in locations where signal strength is low, purchase and install a signal amplifier (booster).
- A signal splitter is required if you want to use two or more projectors through one antenna.
- If you have any problems when installing the antenna, please consult a suitable retailer or the store where you purchased the antenna.

Watching Projector

Initial Setup

The menu screen display in this owner's manual is an example to help users understand how to operate the product and may look different from the actual screen.

- 1 Connect the power cord correctly.
- 2 After waiting for a moment, press the **POWER** button on the remote control or the control panel.
- 3 When you turn on the projector for the first time, a setting screen appears as shown below. Here, you can specify the items required for watching the projector more easily.

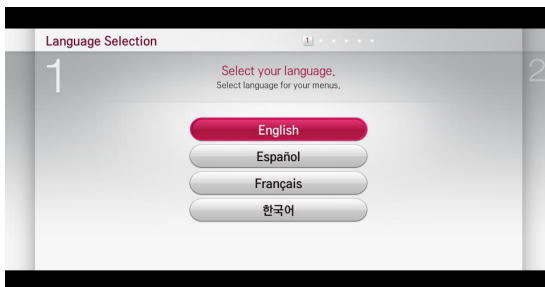
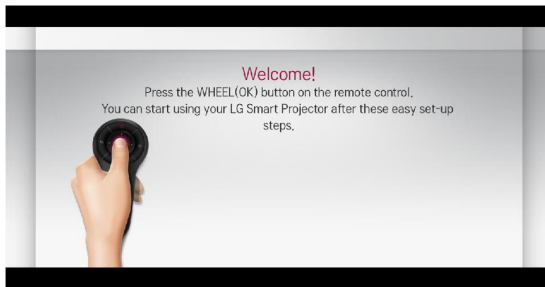

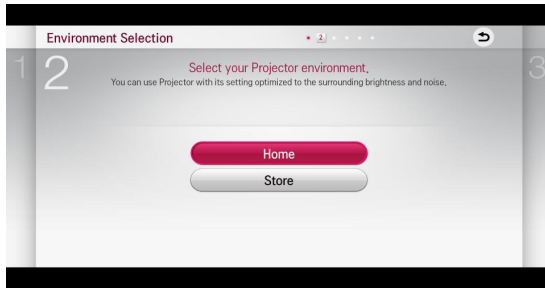

* **Store** mode is used when displaying the product in-store. The picture mode is automatically reset after a certain period of time. You can select **Home** to use the product at home.

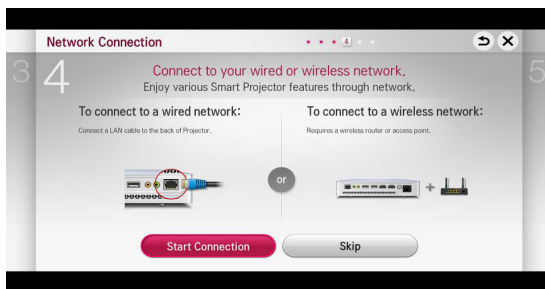
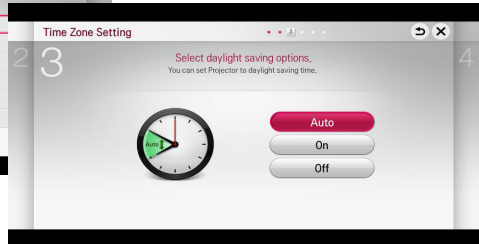
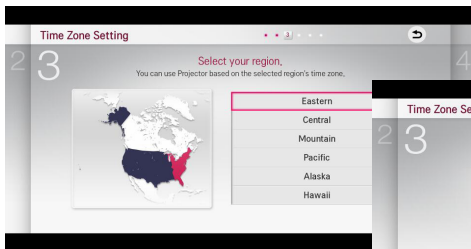

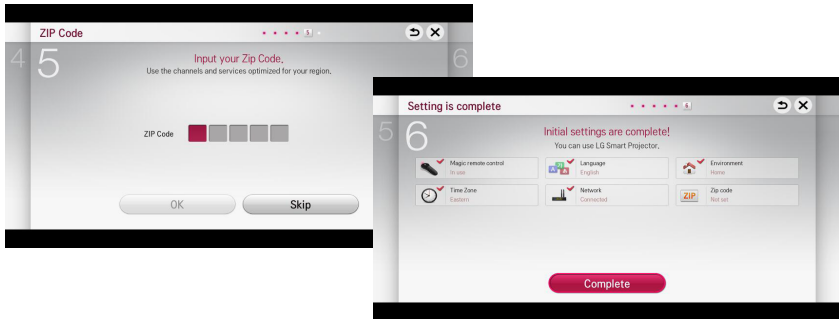

* The initial settings are completed when you select the settings above.

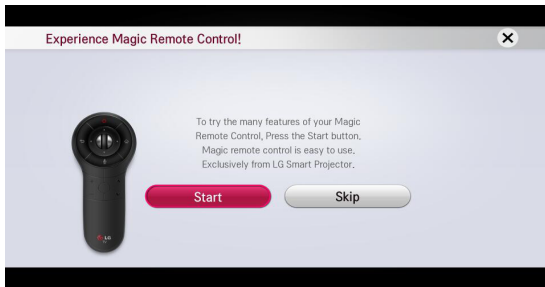

* Simple guide of Magic Remote Control.

NOTE

- For **Auto Tuning** while using the projector, go to **SETTINGS** → **CHANNEL** and select **Auto Tuning**.
- To change the mode while using the projector, go to **SETTINGS** → **OPTION** and select **Mode Setting**.

Focus and Position of the Screen Image

When an image appears on the screen, check if it is in focus and fits the screen properly.

To adjust the focus of the image, rotate the focus ring.

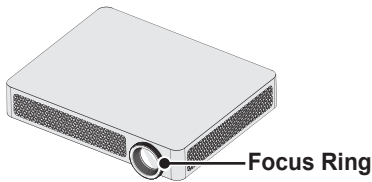

Watching With the Projector

- 1 In standby mode, press the **POWER** button to turn the projector on.
- 2 Press the **INPUT** button and select the input signal you want.
- 3 Control the projector using the following buttons while watching projector.

Button	Description
CH ^, v	Changes the TV channel.
LIST	Displays the channel list.
0 - 9	Enters a channel number.
VOL +, -	Adjusts the volume level.
MUTE	Mutes the sound from the projector.
FLASHBK	Displays the channel you were watching previously.
Key's ▲, ▼	Adjusts the Keystone function.

- 4 To turn the projector off, press the **POWER** button.

To Set Channel

Displays information on current program or current time, etc.
Image shown may differ from your projector.

To View Program Information

- 1 Move the pointer of the magic remote control to the top of the projector screen.
- 2 Click the activated channel banner area.
- 3 The program details will be displayed at the bottom of the projector screen.



	Description
1	Current time
2	Program name/ Detail information on program (for digital broadcast)

To set Favorite Channels

SMART → Settings → CHANNEL → Channel Edit

- 1 Move to the desired channel on **Wheel (OK)** button. Channel is selected.
- 2 Press **Set as Favorite**.
- 3 Select the desired Favorite channel group.
- 4 Select **OK**. Favorite is set.

To use Favorite

SMART → Ch. List

Channel list will appear. Select the desired preset favorite channel from Favorite List A to D.

Additional Options

Adjusting Aspect Ratio

- Select **SMART**  → **Settings** → **PICTURE** → **Aspect Ratio** to change the aspect ratio.
- You can also use the **Q.MENU**, **SETTINGS**, or **RATIO** button.

Menu	Description
16:9	Resizes the image ratio to fit a 16:9 screen.
Just Scan	Displays high-quality image without loss. <ul style="list-style-type: none"> • In DTV/HDMI/Component (over 720p) mode, Just Scan is available.
Set By Program	Depending on the input signal, screen aspect ratio changes to 4:3 or 16:9.
4:3	Resizes the image ratio to fit 4:3 screen.
Zoom	Resizes the image to fit the screen width. The top and bottom parts of the image may be cut off.
Cinema Zoom 1	Formats an image to the cinemascope ratio (2.35:1) and zooms in on the ratio.



NOTE

- Available picture size may differ depending on the input signal.
- The screen aspect ratios on HDMI-PC input are available in 4:3 and 16:9 only.

Using the Keystone Function

To prevent the screen image from becoming trapezoidal, **Keystone** adjusts the top and bottom width of the image if the projector is not set up at a right angle to the screen.

Because the **Keystone** function may cause inferior image quality, use this function only when it is not possible to set up the projector at an optimal angle.

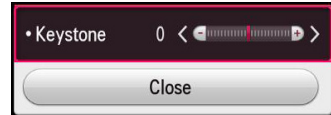

- 1 Press the **Key's** ▲ or **Key's** ▼ button to adjust the picture.
 - **Keystone** can be adjusted from **-40** to **40**.
- 2 Press the **OK** button when done.

Changing Input Device

To select an external input

Selects external input.

- Select **SMART**  → **Input List** or press the **INPUT** button on the remote control to display the input selection screen.
 - Connected inputs are displayed first. However, **AV** is always activated.
- Select an input signal using the remote control's **INPUT** button to connect the projector to the desired input. You can use the < or > button to switch among all the input modes.

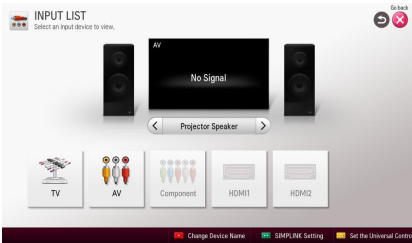

Selecting an Input Label

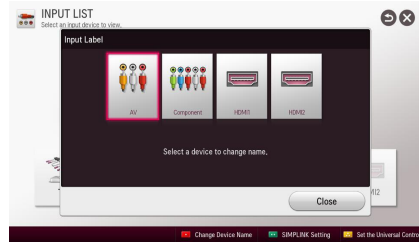

Displays which devices are connected to which input ports.



- 1 Select **SMART**  → **Input List** or press the **INPUT** button on the remote control to display the input selection screen.
- 2 Press the **red** button.
- 3 Press the < or > button to go to the desired input and press the **OK** button.
- 4 Press the ^, v, <, or > button to select a device name.

To Use SIMPLINK

SIMPLINK is a feature that enables you to control and manage various multimedia devices conveniently using the projector remote control only via the SIMPLINK menu.

- 1 Connect the projector's **HDMI IN** terminal with SIMPLINK device's HDMI output terminal using HDMI cable. For home theater units with SIMPLINK function, connect HDMI terminals as above and use an optical cable to connect **Optical Digital Audio Out** from the projector to Optical Digital Audio In of the SIMPLINK device.
- 2 Select **SMART**  → **SIMPLINK**. SIMPLINK menu window appears.
- 3 Select **SIMPLINK Setting** on SIMPLINK menu window. SIMPLINK setup window appears.
- 4 **SIMPLINK Setting to On** in SIMPLINK setup window.
- 5 Close SIMPLINK setup window.
- 6 Select the device to control from **SMART**  → **SIMPLINK**.

NOTE

- This function only works on devices with the SIMPLINK logo (). Verify that the external device has a SIMPLINK logo.
- To use the SIMPLINK function, you need to use a high-speed HDMI[®] cable (with CEC, or Consumer Electronics Control, feature added). High-speed HDMI[®] cables have the No. 13 pin connected for information exchange between devices.
- Turn on or select the media of a device with home theatre features to see the speaker switch to External Speaker.
- Connect with an Optical cable (sold separately) to use External Speaker.
- Switching to external input causes devices operating with SIMPLINK to stop.
- Use of a third-party device with HDMI-CEC features may cause malfunctions.

Explanation Of SIMPLINK Features

Menu	Description
Direct Play	Plays the multimedia device on the projector instantly.
Select multimedia device.	Selects the desired device via the SIMPLINK menu to control it from the projector screen instantly.
Disc playback	Manages the multimedia device with the projector remote control.
Power off all devices	If the Auto Power function is set to On in the SIMPLINK settings, turning the projector off will turn the power off on all SIMPLINK-connected devices.
Sync Power on	If the Auto Power function is set to On in the SIMPLINK settings, turning on a SIMPLINK device will turn the projector on.
Speaker	Selects speaker either on the home theatre unit or the projector.

Using the Quick Menu

You can customize frequently used menus.

- 1 Press the **MY APPS** button to select the **Quick Menu**.
Or press the **SMART**  button and select **Quick Menu**.
- 2 Press the < or > button to select a menu and press **OK**.

Menu	Description
Aspect Ratio	Resizes the picture.
Picture Mode	Changes the picture mode.
Sound Mode	Sets the sound mode.
Sleep Timer	Sets the projector to be turned off at the specified time.
Caption	Sets whether to display captions.
Multi Audio	Sets MONO or STEREO , or a language for a bilingual broadcast (Digital signal).
SAP	Changes the MTS sound (Analog signal).
Energy Saving	Adjusts the brightness.

Menu	Description	
AV Mode	Sets the genre.	
	Mode	
	Off	You can watch using the settings in the video/ audio menu.
	Cinema	Change to optimal video/ audio settings for movies.
	Game	Change to optimal video/ audio settings for games.
Del/Add	Can delete or add channels.	
USB Device	Allows you to remove a connected USB device in a safe manner.	

- 3 Press the \wedge , \vee , \lt , or \gt button to scroll through the following menus.

To Set Sound

To Set Sound Output

To use projector's speakers

Sound is output through the projector speaker.

- **SMART** \uparrow → **Settings** → **SOUND** → **Sound Out** → **Projector Speaker**

To use External Speaker

Sound is output through the speaker connected to the optical port. SIMPLINK is supported.

- Select **SMART** \uparrow → **Settings** → **SOUND** → **Sound Out** → **External Speaker (Optical/HDMI ARC)** to set up as follows.

To use Digital Sound Out

Sets up **Digital Sound Output**.

- **SMART** \uparrow → **Settings** → **SOUND** → **Sound Out** → **External Speaker (Optical/HDMI ARC)** → **Digital Sound Out**

Item	Sound Input	Digital Sound Out
Auto	MPEG	PCM
	Dolby Digital	Dolby Digital
	Dolby Digital Plus	Dolby Digital
	HE-AAC	Dolby Digital
PCM	All	PCM

To connect and use an LG audio device

LG audio device allows you to enjoy rich powerful sound easily.

- **Wired Connection:**

SMART  → **Settings**

→ **SOUND** → **Sound Out**

→ **LG Sound Sync (Optical)**

Connect LG audio device with the



logo to the **OPTICAL DIGITAL AUDIO OUT** port.

- **Wireless Connection:**

SMART  → **Settings**

→ **SOUND** → **Sound Out**

→ **LG Sound Sync (Wireless)**

LG audio device with the  logo can be connected wirelessly.

NOTE

- You can use the projector remote control to adjust the volume of the connected device.
- For a wireless connection, if the device fails to connect, check the device power and make sure the LG Audio device is set up properly.
- When you select **LG Sound Sync (Wireless)**, devices available for connection are searched and one of searched devices is automatically connected. When a device is connected, its name is shown.
- If two or more devices are detected, the first detected device is connected first. To view more detected devices to connect, press the **Show More** button.
- When **LG Sound Sync (Wireless)** is active and you turn on the projector, it will search and try to connect the device which recently connected.

To Connect and Use a Bluetooth headset

Sound output is through the Bluetooth headset.

- **SMART**  → **Settings** → **SOUND** → **Sound Out** → **LG Sound Sync (Wireless)**
- The devices that can be connected are: LG BTS1, LG HBS-700, LG HBS-730, LG HBS-800 (Product availability may vary by country.)
- For wireless connection, if the device fails to connect. Check the device power to connect and if the LG Audio device is in a proper operating condition.
- If two or more devices are detected, the first detected device is connected first. To view more detected devices to connect, press the **Show More** button.

Using the Multi Audio

Multi Audio means stereo and multiple language broadcast from the channel provider.

- **SMART**  → **Quick Menu** → **Multi Audio**

In the case of digital broadcast

Multiple languages can be selected depending on the multi-language signals from the TV station.

- For default language, select at **SMART**  → **Settings** → **OPTION** → **Language** → **Audio Language**.

In the case of analog broadcast

Item	Description
Mono	Left and right speakers produce sound, and the sound model is mono. Select this menu to listen in Mono mode regardless of broadcast state. This can be set for a stereo broadcast signal. Select Mono in poor reception areas (e.g., areas with weak or erratic signals) or when multi audio reception is not clear.
Stereo	The sound mode is in stereo when the sound comes out of both left and right speakers.
SAP	Changes the MTS sound.

ENTERTAINMENT

To Use Smart Features

To Use Home Screen

With all smart projector features on one screen, everyone can access a wealth of content and applications conveniently via the quick and easy-to-use menu, arranged by themes such as Card, MY APPS, etc.

- Press the **SMART**  button on the remote control.



	Description
①	Displays the screen you are currently watching.
②	Displays the premium menu.
③	Edit the card list.
④	Login button
⑤	Displays the list of my apps. Select More at the bottom of the Home screen. Select More to check pre-installed and downloaded apps. Select an app to use.

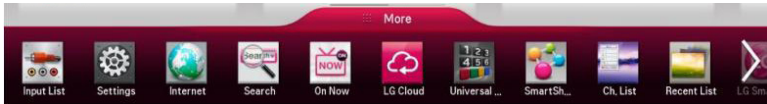

To Use MY APPS

- **SMART**  → **More**
- Select **More** at the bottom of the home screen.
- Select **More** to check apps pre-installed apps and apps you have downloaded.



To Edit Items in MY APPS

On the **MY APPS** page, select  (**Edit**) at the top of the screen to move or delete apps. Please note that system apps can be moved, but cannot be deleted.

- Select **SMART**  → **More** → **MY APPS** →  (**Edit**).
- Changes orders / deletes items by dragging the app icons if your device has a Magic Remote Control.

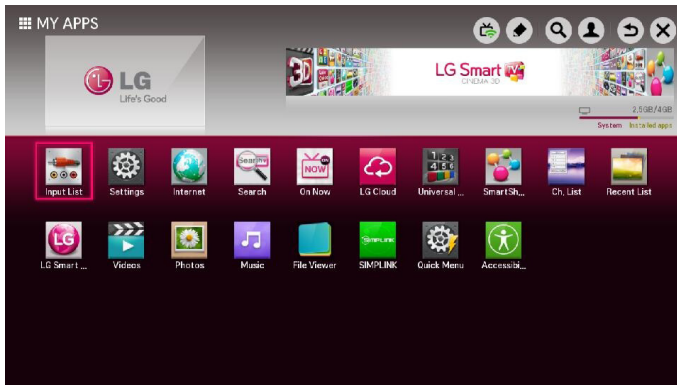

To Connect Network

A wireless or wired network connection is required to use smart features. When connected to the network, you can use premium content, LG Smart World, DLNA and more.

One-click Network Connection

Connects easily to a wired/wireless network.

- **SMART**  → **Settings** → **NETWORK** → **Network connection** to connect to an available network automatically. Follow the prompts on the projector.

To Connect to a Network Through Set Expert

For use in special circumstances such as in offices (in cases where a static IP is used).

- Select **SMART**  → **Settings** → **NETWORK** → **Network connection** → **Start Connection** → **Other Network List** → **Manual Setup**.

- 1 Select a network connection, either **Wired** or **Wireless**.
- 2 When connecting via Wi-Fi, use the one of the following network connection methods.

Item	Description
AP List	Connects to the network selected from the AP List.
Enter the SSID	Connects to the wireless AP typed in.
WPS-PBC	Connects easily when the button of a wireless AP supporting PBC is pressed.
WPS-PIN	Connects easily when the PIN of the wireless AP that you wish to connect to is entered in to the AP website.

To Use the Wi-Fi Direct Function

Wi-Fi Direct is a function that allows your projector to connect with a Wi-Fi Direct device without Internet connection. With SmartShare™, you can watch the files stored on a device connected via Wi-Fi Direct.

- Select **SMART**  → **Settings** → **NETWORK** → **Wi-Fi Direct**.

- 1 Set **Wi-Fi Direct** to **On**. (If you do not use it, please change it to **Off**.)
- 2 Enable the Wi-Fi Direct settings on the device that you want to connect to.
- 3 A list of devices that can be connected to the projector is displayed.
- 4 Select a device to connect.
- 5 Select **Yes** when the connection request message appears.
- 6 If the device that you want to connect accepts the request, **Wi-Fi Direct** is connected.

To Use the Miracast™/Intel's WiDi Function

You can view the screen of a device with Miracast™ and Intel's WiDi technologies on your projector. Contact the device manufacturer to find out if the device supports this function.

- Select **SMART**  → **Settings** → **NETWORK** → **Miracast™/Intel's WiDi**.

- 1 Set **Miracast™/Intel's WiDi** to **On**. (If you do not use it, please change it to **Off**.)
- 2 Enable the **Miracast™/Intel's WiDi** settings on the device that you want to connect to.

- 3 A list of devices that can be connected to the projector is displayed.
- 4 Select a device to connect.
- 5 Select **Yes**, when the connection request message appears.
- 6 If the device that you want to connect accepts the request, **Miracast™/Intel's WiDi** is connected.
 - When **Wi-Fi Direct** is set to **Off**, if you set **Miracast™/Intel's WiDi** to **On**, **Wi-Fi Direct** is automatically set to **On**.
 - When you set the **Miracast™ / Intel's WiDi** function to **Off**, **Wi-Fi Direct** returns to the previous setting.

NOTE

- It is recommended to connect a laptop using **Intel's WiDi** within close range.
- Though **Intel's WiDi** can be connected without a wireless router, it is recommended to connect the wireless router first for optimal performance.
- You may not connect your projector to a non-LG Electronics device even when it is detected.
- It is recommended you to connect a device to a 5 GHz router.
- The response rate may vary depending on the user's environment.
- For more information on the device you want to connect to, refer to its owner's manual.

Tips for Network Settings

- Use a standard LAN cable (Cat5 or higher with RJ45 connector, 10 Base-T or 100 Base TX LAN port).
- Resetting your modem can cause network connection problems. To resolve the problem, turn the power off, disconnect and reconnect, and then turn the power back on.
- LG Electronics is not responsible for any network connection problems or any faults, malfunctions and errors caused by an network connection.
- A network connection may not work properly depending on the Internet service provider.
- A DSL modem is required for a DSL service; a cable modem is required for a cable service. Only a limited number of network connections may be available, and projector network setting may not be available depending on your contract with your Internet Service Provider (ISP.) (If only one device is allowed per line and the PC is already connected, other devices cannot be used.)
- Wireless networks can be subject to interference from other devices operating at a frequency of 2.4 GHz (wireless phones, Bluetooth devices or microwave ovens). There may also be interference from devices with a frequency of 5 GHz, same as other Wi-Fi devices.
- The surrounding wireless environment can cause the wireless network service to run slowly.
- If you do not turn off the entire local home network, network traffic may occur on some devices.
- For an AP connection, an access point device that supports wireless connection is required and the wireless connection feature must be enabled on the device. Contact your service provider regarding availability of wireless connection on your access point.
- Check the SSID and security settings of the AP for AP connection. Refer to the appropriate documentation for SSID and security settings of the AP.
- Invalid settings on network devices (wired/wireless line sharer, hub) can cause the projector to run slowly or not operate properly. Install the devices correctly according to the appropriate manual and set the network.
- Connection method may differ according to the AP manufacturer.

Tag On

What is Tag On?

Tag On is a data transmission technology that can be used on smartphones with NFC (Near Field Communication). Simply by tapping your smartphone to a Tag On sticker, you can share content between your smartphone and projector.

- To connect your smartphone to the projector using Tag On, they must be connected on the same Wi-Fi network or Miracast™/Intel's WiDi of the smart projector is set to On.



NOTE

- Do not attach the sticker to a metal part of the projector. Otherwise, your smartphone cannot recognize the Tag On sticker.
- Do not crumple or fold the Tag On sticker. Otherwise, the Tag On is not recognized.
- To purchase a Tag On sticker, please contact the LG Electronics Service Centre.
- This function is supported only on a smartphone with Android 4.0 (ICS) or later.

To Start Tag On For the First Time

To connect your smartphone to the projector using NFC, install the Tag On app on the smartphone and complete the authentication process.

- 1 Make sure that the smart projector is on the same network as your smartphone. If Wi-Fi cannot be enabled, go to **SMART**  → **Settings** → **NETWORK** → **Miracast™/Intel's WiDi** and set to **On**.
- 2 Enable the smartphone's NFC function and set to **Read/Write and P2P Mode**. For more information on enabling NFC and setting the mode, refer to the owner's manual of your smartphone.
- 3 Tap your smartphone to a Tag On sticker. Make sure to follow the instructions on the smartphone screen and install the Tag On app and LG TV Remote app.
- 4 Tap the smartphone to the Tag On sticker again.
- 5 Enter the pairing key displayed on the smart projector into the smartphone. When two or more projectors are detected, the pairing key is displayed only after the projector you want to connect to is selected in the device list.
- 6 When the connection is made properly, you can use Tag On.
 - The information of the connected projector is saved in the Tag On sticker. You can change or reset the information in the Settings menu of the smartphone Tag On app.

To use the Tag On

Follow the steps below to share content on your NFC-enabled smartphone.

- 1** Tap the NFC-enabled smartphone to a Tag On sticker.
- 2** The Tag On app starts running on the smartphone to connect to the smart projector.
 - To use a Wi-Fi network, make sure that the smart projector is on the same network as your smartphone.
 - If the smart projector and the smartphone are not on the same network, use Wi-Fi Direct.
- If the Tag On app is not installed, the installation page appears automatically.
- For more information on how to share content between your smartphone and projector, refer to the Tag On app's help. Click to run the Tag On app on your smartphone and select the Settings menu to view the help.

SMARTSHARE

Before Using

Connecting a USB Device

Connect a USB device (external HDD, USB memory) to the USB port of projector to enjoy the content files stored in the USB device with your projector. You cannot write or delete data in the USB device. Connect a USB flash drive as shown below.

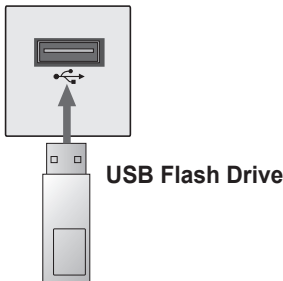

Removing a USB Device

- 1 Press the **MY APPS** button to select the **Quick Menu**.
(Or press the **SMART**  button and select **Quick Menu**.)
- 2 Use the < or > button to move to **USB Device** and press the **OK** button.
- 3 Select a USB to remove. Wait for confirmation that the USB device has stopped before removing the USB.



NOTE

- If detached early, an error may occur on the projector or the USB storage device.
- Once a USB device has been selected for removal, it can no longer be read. Remove the USB storage device and then re-connect it.

Tips for Using a USB Device

- If the USB storage device has a built-in auto recognition program or uses its own driver, it may not work.
- Some USB storage devices may not work or may work incorrectly.
- If you use a USB extension cable, the USB device may not be recognized or may not work properly.
- Use only USB storage devices formatted with the Windows FAT32 or NTFS file system.
- For external USB HDDs, it is recommended that you use devices with a rated voltage of less than 5 V and a rated current of less than 500 mA.
- It is recommended to use a USB hub or hard disk drive with power supplied. (If the power supplied is not enough, the USB storage device may not be detected properly.)
- It is recommended that you use USB flash drives of 32 GB or less and USB HDDs of 2 TB or less.
- If a USB HDD with power-saving function does not work properly, turn the power off and on. For more information, refer to the user manual of the USB HDD.
- Data in USB storage device can be damaged so be sure to back up important files to other devices. Data maintenance is the user's responsibility and the manufacturer is not responsible for data loss.

To use SmartShare™

- 1 Press the **SMART**  button on the remote control.
- 2 Select **SmartShare™**.

You can watch the photo, music, video and document on the projector by connecting a USB or home network (DLNA). The photo, music, video and document files of all devices connected to the projector are displayed. (For the document files, only those in the devices connected via USB are displayed.)

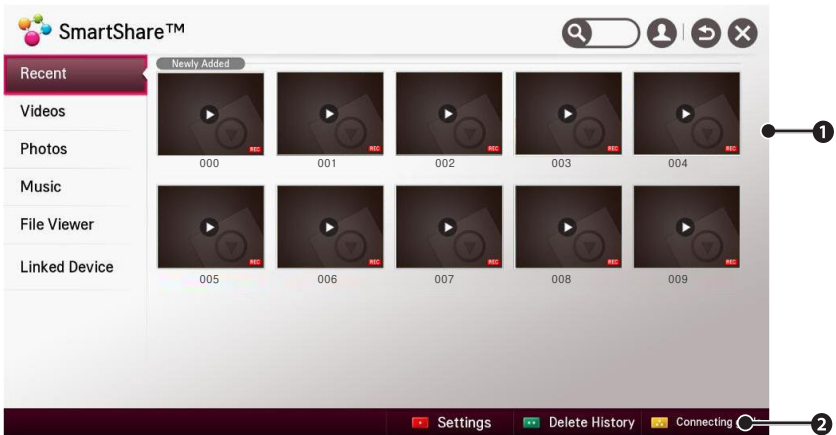

	Description
1	Displays photo / music / video / document files on all devices connected to the projector.
2	Shows how to connect PC, smartphone/device, and USB.

Watching the Videos

In the Movie List, you can watch movies stored on the connected USB device. Controls playback and sets options while viewing videos.

Playing video - warning

- Some subtitles created by users may not work properly.
- The video and subtitle files should be placed in the same folder. In this case, you must assign the same names for the video and subtitle files for proper display.
- Subtitles on an NAS (Network Attached Storage) device may not be supported depending on the manufacturer and model.
- We do not support any stream that contains GMC (Global Motion Compensation) or Qpel (Quarterpel Motion Estimation).
- Full HD Video: 1920 X 1080
 - Only H.264 / AVC profile level 4.1 and lower is supported.
- The file size limit is dependent on the encoding environment.
- Only Window Media Audio V2 and above is supported.
- AAC Main Profile is not supported.
- Video files created by some encoders may not be played back.
- Video files in formats other than the ones specified here may not be played back.
- Playback of video files stored on the USB device that do not support High Speed, may not work properly.
- The projector supports DTS audio codec when the USB/HDMI video file playback.

To control video playback

You can control playback using the following buttons.

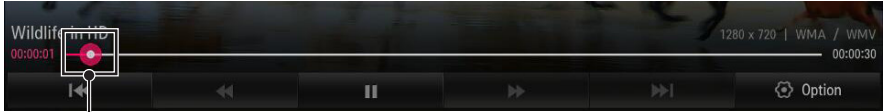

Shows the current playing position. Use the < or > button to move forward or backward.

Item	Description
▶	Resumes normal playback.
	Pauses the video player.
▶▶	Displays in slow motion.
◀▶	Whenever this button is pressed, the playback speed is increased or decreased by one unit.
◀▶▶	Plays the previous/next file.
Option	Sets the option.

Viewing the Photos

You can view photos stored on a connected device.

To control photo view

You can control playback using the following buttons.

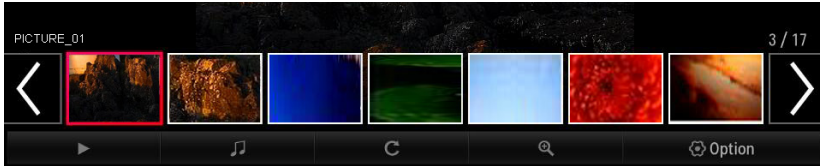

Item	Description
< >	Selects the previous or next photo.
▶	<p>If no picture is selected, all photos in the current folder are displayed in a slide show. If some photos are selected, those photos are displayed in a slide show.</p> <ul style="list-style-type: none"> • Set Slide Speed in the Option → Set Photo View. menu.
🎵	<p>You can listen to music while viewing full-size photos.</p> <ul style="list-style-type: none"> • Set BGM in the Option → Set Photo View. menu.
↻	<p>Rotates photos.</p> <ul style="list-style-type: none"> • Rotates a photo 90 °, 180 °, 270 °, 360 ° clockwise. • Photos cannot be rotated if their width is greater than the height of the maximum supported resolution.
🔍	<p>Enlarges or reduces the photo.</p> <p>Use the Up/Down/Left/Right buttons to select a page and press the OK button.</p>
Option	A setting popup window will appear.

Listening to Music

You can play audio files stored on the connected device.

To control music playback

You can control playback using the following buttons.



Item	Description
⏮ ⏭	Plays the previous/next file.
⏸	Pauses the music player.
▶	Resumes normal playback.
↺	Sets the repeat playback.
✂	Sets the random playback.
📴	Plays music with the projector screen turned off.
⚙	Sets Option for the music list.

- You can control playback using the ⏮, ▶, and ⏭ keys on a standard remote control.
- If you use the USB device, time information will be not shown on screen.

Viewing Files

You can see document files stored on a connected device.

Supported File Formats

XLS, DOC, PPT, TXT, XLSX, PPTX, DOCX, PDF
 Microsoft Office 97/2000/2002/2003/2007 version
 Adobe PDF 1.0/1.1/1.2/1.3/1.4 version

- File Viewer realigns a document, so it may look different from what is displayed on a PC.
- For documents that include images, the resolution may look lower during the realigning process.
- If the document is large or has many pages, it may take longer to load.
- Unsupported fonts may be replaced by other fonts.
- The file viewer may not open for Office documents that contain many high resolution images. In that case, reduce the image file size, save it on a USB storage device and run the file viewer again or connect your PC to the projector and open the file on your PC.

Browsing File Viewer

You can control playback using the following buttons.

- Press the **Go Page** button to move to the previous or next page.
- Press the **volume** button to **zoom in** or **zoom out**.
 - Press the **OK** button.
 - Press the **Up/Down/Left/Right** buttons to move to **Go Page** or **Zoom**.

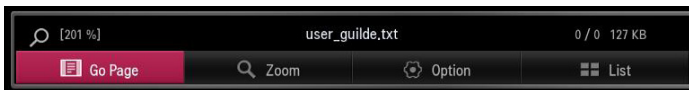

Item	Description
Go Page	Moves to the page you specify.
Zoom	Enlarges or reduces the document.
Option	Sets Option for File Viewer.
List	Returns to a list.

To Set SmartShare™ Related Functions

Select **SMART**  → **SmartShare™** → **Settings**.

Changes settings related to SmartShare™ content playback.

Advanced Setting

Item	Description
My Projector Name	Changes the name that appears when searching for the projector from other devices.
Network Status	Checks the network connection.
Wi-Fi Direct	Allows use of wireless connection functions such as Wi-Fi Direct and WiDi.
Auto Play on Receive	Accepts / rejects content transferred from other devices.
DivX(R) VOD	Registers or releases DivX. Checks DivX Registration Code for playing DivX-protected videos. Register at http://vod.divx.com . Uses Registration Code to rent or purchase movies at www.divx.com/vod . <ul style="list-style-type: none"> • When using the DivX Registration Code of another device, the rented/purchased DivX file cannot be played. Use only the DivX Registration Code granted to this device. • Converted files not conforming to DivX Codec Standard may produce abnormal images and sound.

Delete History

- To delete contents history, press **Delete History** button. Use the contents at **Recent** menu.

SmartShare™ supporting file

- Maximum data transfer rate: 20 Mbps (Mega bit per second)
- External subtitle formats supported: *.smi, *.srt, *.sub (MicroDVD, SubViewer 1.0/2.0), *.ass, *.ssa, *.txt (TMPlayer), *.psb (PowerDivX), *.dcs(DLP Cinema)
- Internal subtitle formats supported: XSUB (supports internal subtitles generated from DivX6)

Video Supported Codec

Maximum resolution: 1920 x 1080 @ 30p

Extension	Codec	
.asf .wmv	Video	VC-1 Advanced Profile, VC-1 Simple and Main Profile
	Audio	WMA Standard, WMA 9 Professional
.divx .avi	Video	DivX3.11, DivX4, DivX5, DivX6, XViD, H.264/AVC, Motion Jpeg, MPEG-4 Part 2
	Audio	MPEG-1 Layer I, II, MPEG-1 Layer III (MP3), Dolby Digital, Dolby Digital Plus, LPCM, ADPCM, DTS
.mp4 .m4v .mov	Video	H.264/AVC, MPEG-4 Part 2
	Audio	AAC , MPEG-1 Layer III (MP3)
.3gp .3g2	Video	H.264/AVC, MPEG-4 Part 2
	Audio	AAC, AMR-NB, AMR-WB
.mkv	Video	H.264/AVC
	Audio	HE-AAC, Dolby Digital
.ts .trp .tp .mts .m2ts	Video	H.264/AVC, MPEG-2, VC-1
	Audio	MPEG-1 Layer I, II, MPEG-1 Layer III (MP3) Dolby Digital, Dolby Digital Plus, AAC
.vob	Video	MPEG-1, MPEG-2
	Audio	Dolby Digital, MPEG-1 Layer I, II, DVD-LPCM
.mpg .mpeg	Video	MPEG-1, MPEG-2
	Audio	MPEG-1 Layer I, II, MPEG-1 Layer III(MP3), AAC

Audio File

File type	Item	Info
mp3	Bit rate	32 Kbps - 320 Kbps
	Sample freq.	16 kHz - 48 kHz
	Support	MPEG1, MPEG2, Layer2, Layer3

Available photo file

File type	Item	Profile
2D (jpeg, jpg, jpe)	JPEG	Minimum: 64 x 64 Maximum: Normal Type: 15360 (W) x 8640 (H) Progressive Type: 1920 (W) x 1440 (H)

To Use the LG Cloud

What is the LG Cloud?

LG Cloud is a service that allows you to enjoy your contents, such as video, music and photos on your LG Projector, SmartPhone and LG Website at any time, regardless of where you are.

- **SMART**  → **More** → **LG Cloud**
- Sign up for LG Cloud to use the services.
- You can sign up from your LG Smart projector, SmartPhone or LG Website.
- The service or membership can only be cancelled at the LG Cloud website (<http://www.lgecloud.com>).

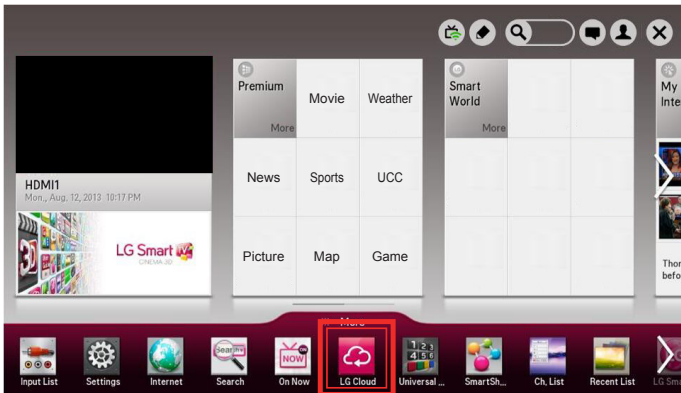

To Use the LG Cloud

- SMART  → More → LG Cloud
- Enter the e-mail and password you provided during the sign-up procedure to sign in to the service.

Main screen layout

This is the main screen you will see first after signing in.

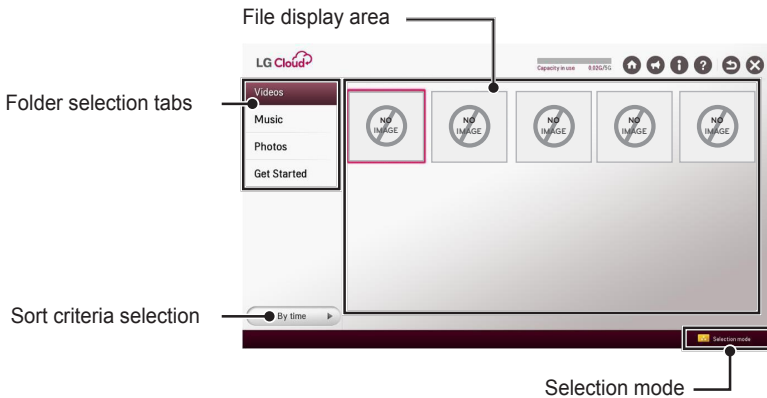

Video playback

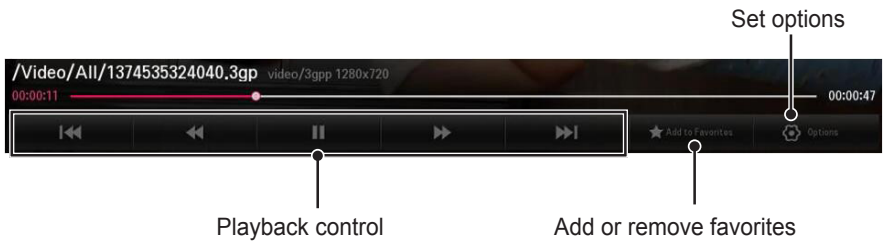

LG Cloud Move to Home/Notice/My Account/FAQ

Item	Description
Move to Home	Displays a default screen.
Notice	Shows notices about the LG Cloud service.
My Account	Shows the user ID and e-mail address.
FAQ	Displays the FAQ regarding LG cloud service.

To Connect DLNA

DLNA stands for Digital Living Network Alliance, which allows you to enjoy video / music / photo files stored on a PC or server on your Projector via home networking.

To Connect a DLNA-Authenticated Smartphone

The Projector and the smartphone should be on the same network.

- 1 Enable Wi-Fi on the smartphone.
- 2 Install/run a DLNA app to share content on the smartphone (It's called SmartShare on LG phones).
- 3 Run **Share my mobile phone Content**.
- 4 Select the kind of Content (video/ music/photo) to play.
- 5 Select the video, music or photo file to play on the projector.
- 6 Select **Add to Play List**.
- 7 Select projector model name on the device to replay content. (projector model name is on the label of the device.)
- 8 Play ▶ Shows the selected file on projector.

To Connect DLNA DMR (Digital Media Renderer)

With the Windows 7 or Windows 8 PC operating system or DLNA-certified device (e.g. mobile phone), music/ videos/photos may be played on projector without installing a separate program.

- 1 Configure Projector and PC on the same network. Configure the Windows 7 or Windows 8 PC on the network.
- 2 To play a music/video/photo file, right-click on the file and use the Remote Playback or PlayTo Windows 7 or Windows 8 feature. For playback on devices like a mobile phone, refer to the model's user guide.
- 3 Content will be played on only one device even if more than one projector or device is connected. Play speed can vary depending on network speed.

To Connect DLNA DMP (Digital Media Player)

With a PC having SmartShare™ PC software, music / video / photo files may be replayed on the projector via home networking.

- 1 Configure projector and PC on the same network. The projector and each device should be connected through a single access point to enable DLNA service.
- 2 Install SmartShare™ PC software on the PC from the website. Before installation, close all running programs including firewall and anti-virus programs.
- 3 The sever should be running in order to watch the shared file on your projector.
 - For the website information, go to **SMART**  → **Settings** → **SUPPORT** → **Product/Service Info.**
 - For how to use the SmartShare™ PC software, refer to the software help.

SmartShare™ PC SW Installing and Setting

Install the SmartShare™ PC SW (DLNA) program on your PC.

- 1 Download the setup file from the path below in order to use the DLNA function.
<http://liu.lge.com/smartshare/release/smartshare.zip>
- 2 Install the downloaded SmartShare™ PC software.
- 3 You can run the program when installation is complete.



NOTE

- DLNA or Media Link service is only available if projector and other devices are connected via a single router.

PC requirement for installing LG SmartShare™

Item	Minimum Specifications	Recommended Specifications
CPU	Intel Pentium4 2.0 G or higher/ AMD Sempron 2000 or higher	Intel Pentium Dual Core or higher/AMD Athlon 64 x 2 or higher
RAM	1 GB or higher	2 GB or higher
VGA	64 MB RAM, 1024 x 768 or higher resolution, and a video card that supports 16 bit or more colors	128 MB RAM, 1024 x 768 or higher resolution, and a video card that supports 16 bit or more colors
Hard Disk Drive	200 MB or higher	
Operating System	Windows XP (Service Pack 2 or later), Windows Vista, Windows 7, Windows 8 I Windows Media Player: 11.0.5721.5280 or higher is recommended	
Network Environment	100 MB Ethernet, Wireless LAN (WLAN) IEEE 802.11g or higher	

- Program speed can be delayed depending on the system performance and the network environment.

In Case of a DLNA Malfunction

- If a DLNA feature does not work properly, check network settings.
 - A 5-GHz access point is needed to view 1080p videos via DLNA. A 2.4-GHz access point may cause frequent buffering or other problems.
 - DLNA may not work properly on a wireless network. It is recommended to use a wired connection.
 - Multi audio and internal subtitles are not supported in DLNA mode.
 - If more than one Projector is connected to a single server in DLNA mode, the content may not play depending on server performance.
 - Subtitles may not be supported depending on the DLNA device.
 - The DLNA feature may not work properly in all network environments.
 - The DLNA feature cannot be used with some access points that do not support multicasting. For more information, refer to access point manual or consult with the manufacturer.
 - Supported file types may differ depending on the DLNA server environment, even for file types supported by the projector.
 - Too many sub-folders and files included in one folder may cause a malfunction.
 - Information about the file from DLNA server may not be displayed correctly.
 - SmartShare™ PC Software is recommended when watching video subtitles from a DLNA server.
- To add a subtitle file later, turn off the shared folder and reset.
 - DRM files located in SmartShare™ PC Software server are not played.

To Use A Premium Service

- SMART  → Premium
- This service gives you easy access to a wide variety of content, such as video, news, and UCC, at any time, as long as you are connected to the network. Premium content includes specialized country-specific services taking regional cultural sensitivities into account as well as global content.

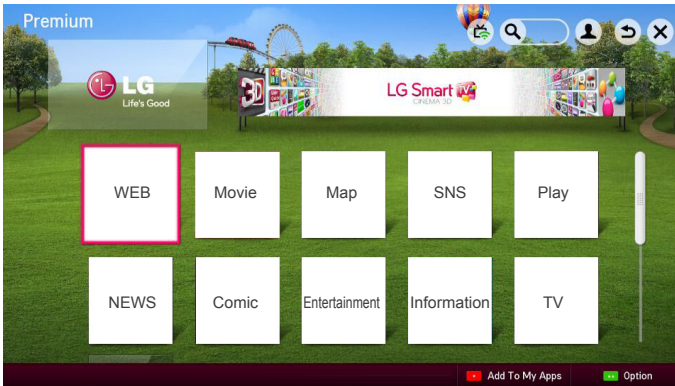

To Use Paid Content

- A fee is payable for some Premium content. Fee-paying services are paid for either through LG Electronics' proprietary billing system or through that of the relevant content provider. Before using the LG billing system, you will need to sign up for membership and register payment information on projector or the website (www.lgapstv.com) to purchase paid content.
 - You can sign up for membership on the login screen on your projector or our website. You can then log into both the projector and the website with one ID.
- 1 Click Sign In button on the upper-right side of the screen on the home page to sign in.
 - 2 Moves to the desired Premium service. (For some premium services, separate sign-in is required after signing up for the premium service.)
 - 3 After reviewing the pricing and service information for the content, click the Purchase button. (There may be limitations on the available period and number of times depending on content.)
 - 4 Once the purchasing process is complete, view your purchased content by clicking the Buy button.
 - 5 Select your ID on upper menu of Home screen and check history of purchases from **My Page** → **Payment inquiry**. It is also available on **My Page** → **Purchase History** of web site (www.lgapstv.com).

To Reset Premium

- **SMART**  → **Premium** → **Option** → **Initialization of Premium**
- Resets premium list, premium information, country setting, and user sign-in information.
- Resetting will resolve errors occurring during premium update.



NOTE

- Content offered by service providers is subject to change or deletion without prior notice to enhance their service quality. Refer to the website of the relevant content provider for questions, troubleshooting, or the latest information about content. LG Electronics assumes no legal responsibility for content services and related information, even when a service is discontinued by the service provider.
- The quality of your premium service may be affected by your Internet connection. For any questions related to Internet speed or other service problems, consult your Internet service provider.
- For best service quality, we recommend that you subscribe to an Internet service providing a speed of 4.0 Mbps (1.5 Mbps or faster). If you experience any Internet speed problem, contact your Internet service provider.
- Some content providers may provide content that is unsuitable for minors. Parental discretion is advised.

To use LG Smart World

- SMART  → LG Smart World

LG Smart World is a projector application service available through Smart projector Service. You can download and enjoy many different apps (for fee or free) including education, entertainment, life and news.



	Description
①	Sign in. When you sign in, ID is displayed. When you select the ID, you can select My Page and Sign Out .
②	Select the app to install.

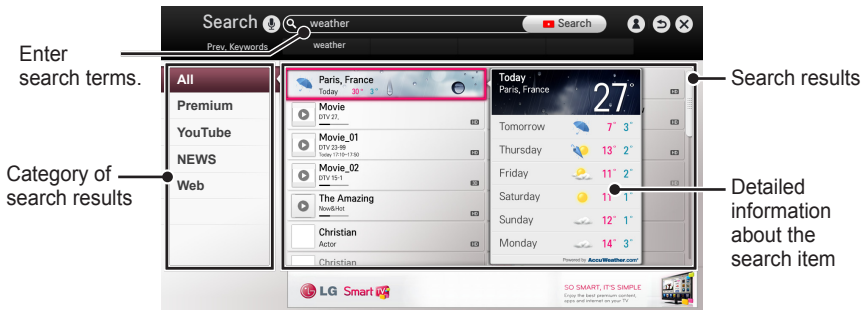

To Use Search Function

- **SMART**  → **Search**
- You can search apps and contents using the Search function of LG Smart Projector. When you enter keywords using the input device, such as the remote control, you can find apps of LG Smart World and some contents of the Premium service. Links are also provided to go for web search. If you are using SmartShare™, you can also search contents of SmartShare™. The Search categories and content types vary depending on the country and will be kept updating.





To Use the Voice Recognition Function

Using this Function Through Search

- 1 Go to **SMART**  → **Search**. Select the voice recognition icon () on the left of the text field.
- 2 Speak slowly and clearly after the voice recognition window appears.
- 3 After the voice recognition is completed, the Similar List window pops up. If the pop-up window does not have the results you want, press Retry to try again. Select the most similar result, then it will be displayed in the text field. Press the Search button to get the result you want.

Using this Function on the Internet

- 1 Go to **SMART**  → **Internet**.
Move the Magic Remote Control pointer in the text field on a website to open the virtual keyboard.
- 2 Select the voice recognition icon () on the left of the text field on the virtual keyboard.
- 3 Speak slowly and clearly after the voice recognition window appears.
- 4 After the voice recognition is completed, the Similar List window pops up. If the pop-up window does not have the results you want, press Retry to try again. Select the most similar result, then it will be displayed on the text field. Press the Search button on the website to get the result you want.

To Use Voice Mate Function

What Is Voice Mate?

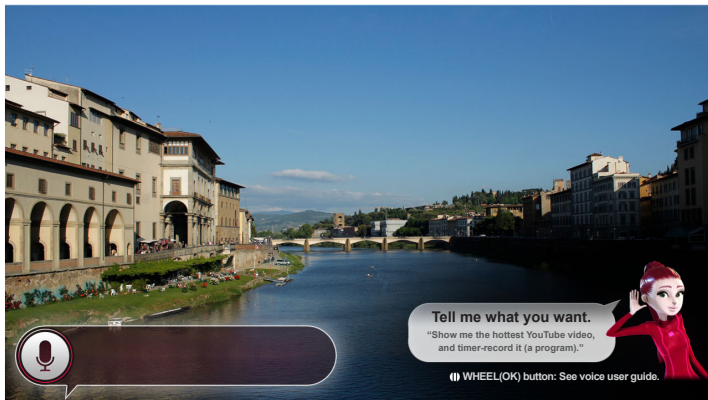

Voice Mate allows you to search desirable programs and content with your voice and adjust the projector.

- 1 Press the voice recognition (🗣️) button on the magic remote control.
- 2 When the Voice Display bar is activated on the left of the screen, say what you want to watch.



- 3 Press the **Wheel (OK)** button with the Voice Search standby to see the supported language in the voice guide.

How to Use Voice Mate?

- To use all the functions and services of Voice Mate, you need to set Smart Wizard and Time. Set up the network, region, auto tuning, and universal remote control through the Smart Wizard.
- In order to use Voice Mate, you must set up the network, time, region, and tuning.
- Set the language of your country to use Voice Mate.
- You can change the language for Voice Search in
SMART  → **Settings** → **OPTION** → **Language** → **Voice Recognition Language**.
- You can turn the avatar **On/Off** in
SMART  → **Settings** → **OPTION** → **See Avatar**.
- Point the universal remote control towards the set-top box when you use Voice Mate with it.
- When speaking a command, hold the remote within 10 cm (3.9 inches) of your face.
- The voice search may fail when you speak too fast or too slow.
- The recognition rate of Voice Mate may vary depending on the user's characteristics (voice, pronunciation, intonation, and speed) and the environment (noise and projector volume).
- If your voice is not recognized properly, Voice Mate may function regardless of your intention.

What Are Other Functions of Voice Mate?

You can access various Projector features using Voice Mate.

Item	Description
Channel	<ul style="list-style-type: none"> • You can tune TV channels and search channel information. Example: "What time is *** on?"
Recommendation and Search	<ul style="list-style-type: none"> • You can recommend and search TV programs and content files. Example: "Look up ***"
Information and Internet	<ul style="list-style-type: none"> • You can also search other information such as today's weather. Example: "How's the weather today?"

- Available functions may vary depending on the country.
- For more supported examples, see the voice user guide.

What Is On Now?

On Now allows you to select and watch recommended programs currently available on your Projector. The Favorite function allows you to select and watch recommended content related to the program you are watching.

To Use On Now

To see in Mini view

- SMART  → On Now

Refreshes all list items and moves to the beginning of the screen simultaneously.

Moves to Full View.

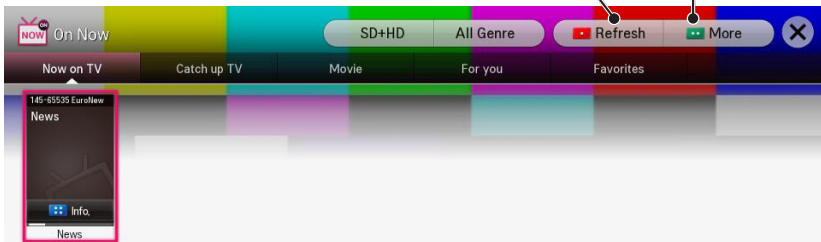

To See in Full View

- SMART  → My Card → On Now

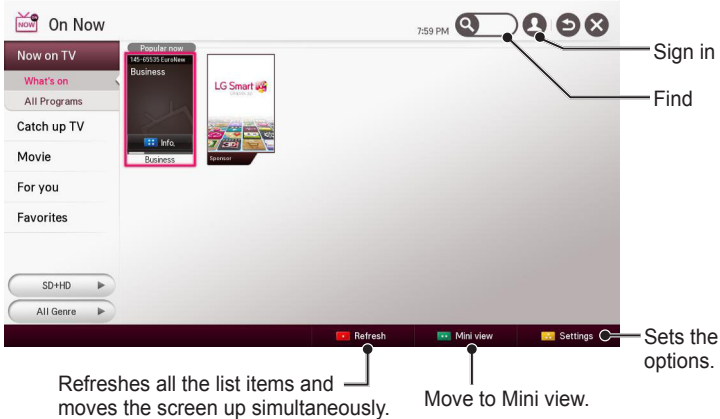

- For TV channels, you need to complete Auto Tuning to use this service properly.
- If you move to a different region, you need to set the region to your current location in order to use this service.
- The digital EPG (Electronic Program Guide) information which the TV receives may be different from the programs on the On Now TV list which uses an external EPG (Electronic Program Guide).
- You can control a connected set-top box tuner with the magic remote control.
- An internet connection is required to use On Now.
- The channels in the On Now TV list are provided from the cable broadcasting service provider. If the provider changes them without notice, the actual TV channels may differ.
- The channel names of analog cable broadcasting on the On Now TV list are provided from an external EPG (Electronic Program Guide), so each name refers a cable broadcasting service provider but may not match.
- The program thumbnail image on the On Now TV list is the representative image of the program, and it may be different from the image of the actual TV program schedule.
- If the channel information on the On Now TV list is different from the actual TV channel or set-top box channel, set the set-top box and channel menu in the On Now Settings.

To Use Internet

- **SMART**  → **Internet**

Types URL manually on Projector or visits websites added to favorite.

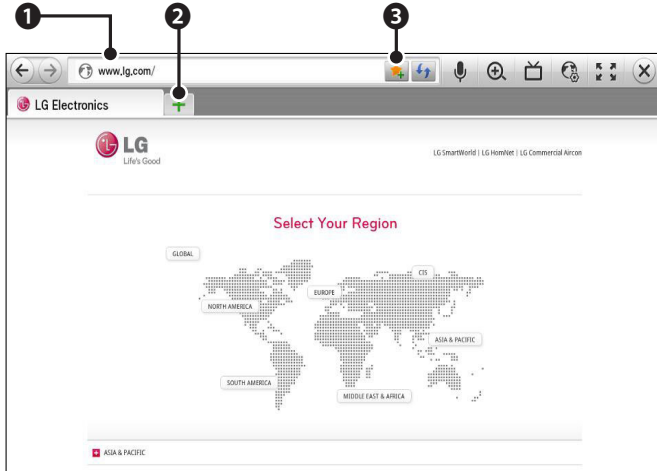

	Description
①	Types in the web address.
②	Chooses when you open several web browsers.
③	Add the current page to favorites.

- **Internet** supports up to Flash 11 but does not support platform-dependent technology like ActiveX.
- **Internet** only works with a pre-installed plug-in.
- **Internet** may not play any media file format other than the following:
JPEG / PNG / GIF
- **Internet** will be forcibly closed when there is insufficient memory.
- For the **Internet**, fonts installed on the projector are used and may not be displayed normally depending on the content played.
- **Internet** does not support file and font download.
- **Internet** is made for projector so it may have a different function to browsers made for PC.
- **Internet** is a projector browser and may not work properly when playing some content files.



Frequently Asked Questions for Smart Projector

Sign up is required to use LG Smart World.

You can sign up on either your Projector or the LG website (www.lgappstv.com). Free apps are available immediately after signing up.

You can purchase paid apps using your credit card registered with the website or credits. Paid apps can also be purchased through carrier billing.

Problem	Solution
When entering menu, the Initializing message always appears.	<ul style="list-style-type: none"> The Initializing message shows you how long it takes to reboot the microprocessor and hardware, set up network communications, and communications with SDP (device authentication and basic information download). It takes about 20 seconds and this is a normal process.
There is no content shown on the Premium card.	<ul style="list-style-type: none"> Content may not be shown after changing the country setting on Smart Projector. Change to desired country in SMART  → Settings → OPTION → Service Country Setting.
While using internet features, there is a blank space on some Web pages.	<ul style="list-style-type: none"> The internet of the Projector supports up to Flash 11 and may not replay any file format other than the following : JPEG, PNG, GIF
Internet closes automatically when visiting website.	<ul style="list-style-type: none"> If memory is insufficient because of large volume of image information in the web page, the browser may be forced to close.
I already signed up on projector. Do I need to sign up again at web site (www.lgappstv.com)?	<ul style="list-style-type: none"> If you sign up on your projector, no additional sign-up on the LG website (www.lgappstv.com) is required. After signing up on the projector, you can sign into the website by using the same ID and password and entering the additional information to complete the email verification process.

Problem	Solution
<p>Can each family member use a different ID with a single projector?</p>	<p>It is possible to register and use more than one ID on one projector.</p> <p>To check the ID registered with Projector from SMART  → Sign In → ID List.</p> <p>You can check the list of apps purchased by each ID. However, you can see all apps installed by each ID in SMART  → Sign In → My Page.</p>
<p>What should I do if I forget my ID?</p>	<p>After signing up on a PC, use the Forgot ID? feature on web site (www.lgappstv.com) when needed.</p> <p>After signing up on Projector, check it from SMART  → Sign In → Find ID.</p>
<p>I purchased an app from the LG web site (www.lgappstv.com). How can I use it on the projector?</p>	<p>To check purchased apps from the Projector, sign in and open the Purchased Apps menu.</p> <p>Select the ID at the top of Home and check the app in My Page → Purchased apps.</p>
<p>Can I see history of my purchased apps?</p>	<p>Select the ID at the top of Home and check the app in My Page → Purchased apps.</p> <p>Sign in to website (www.lgappstv.com) and then select My Page → Purchase History.</p>
<p>I deleted a paid app. Do I have to purchase again to download it?</p>	<p>If a purchased app is accidentally deleted, you can download and reinstall it without having to buy it again, as long as it is still in service.</p> <p>Select the ID at the top of Home and re-download apps in My Page → Purchased apps.</p> <p>(Previously owned apps may not be re-downloaded or run depending on the software version.)</p>
<p>Can I use apps from LG Smart Projector's LG Smart World on both a projector and a PC?</p>	<p>Please check if the projector model supports LG Smart World.</p> <p>The apps provided from LG Smart Projector's LG Smart World can only be used on an LG Smart Projector.</p> <p>Apps may be purchased from the website (www.lgappstv.com) but cannot be used on a PC or Mac. Use care when purchasing.</p>
<p>How can I check the ID currently signed in on the projector?</p>	<p>Select the ID at the top of Home and check the currently signed-in ID in My Page → My Information.</p>

Problem	Solution
I installed an app on the projector. Where can I check the installed app?	Select SMART  → More → MY APPS . All paid and free apps installed on projector are displayed.
There is a difference between the app size shown on the screen and the actual app size installed on projector.	The app size shown in the screen includes the additional space needed for installing apps so it may be different from actually installed app size.
I forgot my password on the projector. What should I do?	<p>If you only provide the ID and password when signing up on your projector, you cannot recover your password when it is lost. Create a new ID and sign up with the ID.</p> <p>If you provide other information than the ID and password when signing up on your projector or the LG website (www.lgapstv.com), you can recover your password on the website.</p>
Do I need to store payment information in web site to purchase paid apps?	<p>The following payment methods are available to purchase paid apps on your projector: credit card, credits, and carrier billing.</p> <p>To purchase paid apps using your credit card or credits, you should have a credit card registered with the LG website (www.lgapstv.com) or have enough credits. Paid apps can also be purchased through carrier billing if your credit card details are not registered with the website or you do have enough credits. If you purchase paid apps on the website, the following payment methods are available: credit card or credits.</p>
Can I cancel an app that I have purchased?	<p>As a member you cannot demand refund just because you changed your mind after purchase. If there is a defect in the product or a problem of using the product, which is not caused by your fault, you can ask for a refund. However, the valid reason for refund must be provided.</p>
Should I use only an email address for my ID?	<p>For new sign-up members, the ID format has changed from a combination of alphanumeric to your email address.</p> <p>You can use only an email address for your ID when signing up.</p>

Problem	Solution
Do I need to change my ID format to the email address?	For new sign-up members, the ID format has changed from a combination of numbers and alphabets to the email address. If you are already a member, you can still use your existing ID or change it to the email address.
What is the LG account?	The LG account allows you to sign into all of the LG Smart service with a single ID and password. You can use the following services with your LG account: LG Smart Projector, LG Cloud, LG Smart World (excluding some countries), LG Smart ThinQ, and LG Smart air conditioning, etc. Additional information may be required depending on the service.

USING ADVANCED FUNCTIONS

To Use Screen Remote

To Use Screen Remote

Press the **123** button on the magic remote control.

Select a button on the screen remote displayed on the screen using the magic remote control.

- The type of buttons on the screen remote varies depending on the region or the type of a connected device.
- Image shown may differ from your projector.

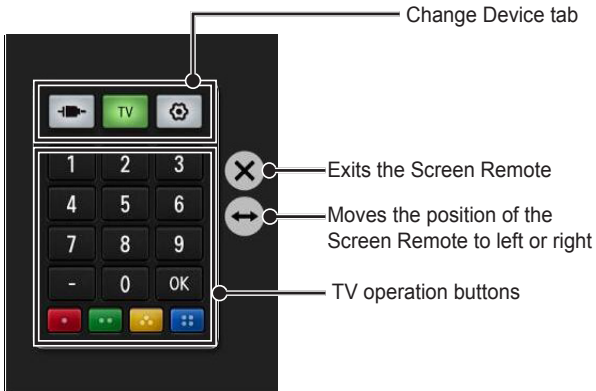

To Control a Device Connected to the Projector Using the Screen Remote

You can control a device connected via SIMPLINK or MHL using the Screen Remote.

- 1 Check if the device is connected to the projector.
- 2 After pressing the **123** button on the magic remote control, select the device you want to control in the Change Device tab. The screen remote that can control the device appears.
 - This may not work with some buttons.



To Use the Universal Control function

For magic remote control only

With the magic remote control, you can control a set-top box, Blu-ray player, home theatre system, etc.

- 1 Check if a device you want to set is connected to your Projector.
- 2 After pressing the **1|2|3** button on the magic remote control, select the icon of a device you want in the change device tab.
If there is no device you want, press the  on the tab, and select the external device you want. Once the setup is complete, the name of the selected device is displayed in the Change Device tab.
- 3 When you select a device you want in the change device tab, the screen remote that can control the device appears on the screen.

To change or clear the Universal Control settings

- 1 After pressing the **1|2|3** button on the magic remote control, select the  (TV/input selection) button.
- 2 Select **Change Settings** or **Cancel Settings** at the bottom of the device to be changed.
 - When change setting, check if the power of the device to be changed is turned on.
 - You can set one device per type.
 - With the screen remote, you can only control the devices of a brand or manufacturer that you can select in the setup screen.
 - If you connect to a network before setting the universal remote control, update for the latest manufacturer list is available.
 - Some buttons may not work depending on the external device model.
 - Place the device near the projector for seamless operation.
 - If the device is in a drawer, open the drawer.
 - Go to **SMART**  → **Universal Control** or, **SMART**  → **Input List** → **Set the Universal Control** and add, delete, or change a device.

To Control a Projector Using a Smartphone

You can download the LG TV Remote app from Google Play Store or Apple App Store and use it on any projector connected with your smartphone.

- Now you can enjoy your favorite projector shows on your smartphone. (Some models only)
- You can easily enter your account information to log in.
- You can add your favorite channels on your smartphone.
- You can use the functions such as **Premium, MY APPS**, and **SmartShare™** directly on your smartphone.
- The text input function is supported, so you can enter text easily. (Text cannot be entered on some screens.)
- Select the app's touch pad to control in the same way the pointer of the magic remote control works.
- Keypad which allows you to control the set-top box and media devices is provided. (Some models with specified conditions only.)
- You can set the projector to the power-saving mode while watching Projector on your smartphone.
- The supported functions may vary depending on the version of the LG TV remote app.

To Use a USB Input Device On a Projector

To Use a USB Wired/wireless Mouse

Connect your mouse to the USB port. Use the mouse to move the pointer on the Projector screen and select the menu you want.

Mouse	Magic Remote Control
Left Button	OK Button on Magic Remote Control
Wheel Button	Wheel Button on Magic Remote Control

- The right and the special buttons on the mouse do not work with the Projector.
- The usability of a wireless USB mouse and keyboard may be affected by Radio Frequency environment and the distance.

To Use a USB Wired/wireless Keyboard

Connect your keyboard to the USB port. You can enter text with the keyboard when using the search function and the Internet.

- Text cannot be entered on some screens.
- It is recommended to use the product which is tested for compatibility with the LG Projector.
- LOGITECH K200, LOGITECH K400, MICROSOFT Comfort Curve 2000, MICROSOFT MS800, and LG Electronics ST-800
- You can change the input language by pressing the language switch key (or the right Alt key) on your keyboard.

CUSTOMIZING SETTINGS

SETTINGS

- 1 Press the **SETTINGS** button.
(Press the **SMART**  button and select **Settings**.)
- 2 Use the \wedge or \vee button to select the desired item and press the **OK** button.
- 3 Use the \wedge , \vee , \lt , or \gt button to set up the desired item and press the **OK** button.
- 4 Press the **EXIT** button when completed.

Menu	Description
PICTURE	Adjusts the image quality for optimal viewing.
SOUND	Adjusts the sound quality and volume level.
CHANNEL	Sets up or edits a channel.
TIME	Sets the time and time-related features.
LOCK	Locks or unlocks a channel or a program.
OPTION	Customizes the general settings.
NETWORK	Sets the network.
SUPPORT	Shows the projector information.

PICTURE Settings

- 1 Press the **SETTINGS** button.
(Press the **SMART**  button and select **Settings**.)
- 2 Use the \wedge or \vee button to select **PICTURE** and press the **OK** button.
- 3 Use the \wedge , \vee , \lt , or \gt button to set up the desired item and press the **OK** button.
 - To return to the previous menu, press the \rightarrow button.

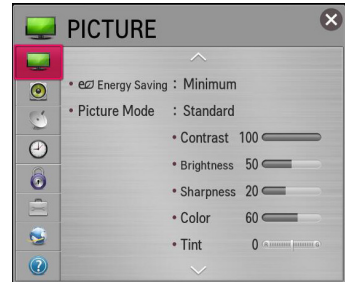

The available picture settings are described as follows.

Item	Description	
Energy Saving	Reduces power consumption by adjusting screen brightness.	
	Mode	
	Minimum/ Medium/ Maximum	Applies the pre-set Energy Saving mode. - If Energy Saving is set to Minimum and the ambient temperature is 35 °C or higher, Energy Saving will be disabled. - If Peak Mode is enabled, Energy Saving will be disabled.
Picture Mode	Selects the picture mode optimized for the viewing environment or the programme. You can also customize advanced options for each mode.	
	Mode	
	Vivid	Maximizes the visual effect of video. Heightens contrast, brightness, and sharpness to display vivid images.
	Standard	Displays images in standard levels of contrast, brightness, and sharpness.
	Cinema	Optimizes the image for a movie.
	Game	Optimizes the image for playing games on fast-moving screens.
	Expert1/2	Menu for adjusting picture quality that allows experts and amateurs to enjoy the best projector viewing. - Expert mode is for picture tuning professionals to control and fine-tune using a specific image. For normal images, the effects may not be dramatic.
Contrast	Adjusts the difference between bright and dark regions of the screen.	
Brightness	Adjusts the overall screen brightness.	

Item	Description
Sharpness	Adjusts the sharpness of the borders between bright and dark. Horizontal and Vertical Sharpness are available only in Expert1/2 .
Color	Adjusts the colors on the screen darker or lighter.
Tint	Adjusts the red/green color balance.
Advanced Control (Expert Control)	Customizes the advanced settings.
Picture Option	Sets optional settings.
Picture Reset	Resets values customized by the user. Each picture mode is reset. Select the picture mode you wish to reset.
Aspect Ratio	Resizes the picture.
Picture Wizard II	Use the remote control and follow the instructions of the Picture Wizard to calibrate and adjust for optimum picture quality without expensive pattern devices or help from a specialist. Follow the instructions to obtain the optimum picture quality.

Advanced Control

Item	Description
Dynamic Contrast	Adjusts contrast and color to the optimal level according to the screen's brightness.
Dynamic Color	Adjusts colors for more natural-looking colours.
Preferred Color	Skin Color Skin color spectrum can be separately set to implement the skin color as defined by the user.
	Grass Color Natural color spectrum (meadows, hills, etc.) can be separately set.
	Sky Color Sky color is set separately.
Super Resolution	Provides a crystal-clear picture by improving the details in areas where the picture is blurry or unclear.
Gamma	Sets the gradation curve according to the output of the picture signal in relation to the input signal.

Expert Control

Item	Description
Dynamic Contrast	Adjusts contrast and color to the optimal level according to the screen's brightness.

Item	Description
Super Resolution	Provides a crystal-clear picture by improving the details in areas where the picture is blurry or unclear.
Color Gamut	<p>Selects the range of colors that can be expressed.</p> <ul style="list-style-type: none"> • Standard: Displays the original colors of an input signal regardless of the display features. • Wide: Makes use of the display's rich colors.
Edge Enhancer	Shows clearer and distinctive yet natural edges of the video.
xvYCC	Displays much richer colors.
Color Filter	Filters a specific color spectrum in RGB colours to fine-tune colour saturation and hue accurately.
Expert Pattern	Patterns used for expert adjustment.
Gamma	Sets the gradation curve according to the output of the picture signal in relation to the input signal.
White Balance	<p>Adjusts white balance. Detailed adjustment is possible as shown below.</p> <p>a. Method: 2 points</p> <ul style="list-style-type: none"> - Pattern: Inner, Outer - Points: Low, High - Red/Green/Blue: Adjustable range -50 - +50. - Apply to all inputs: The values of the White Balance is applied to all the input modes. <p>b. Method: 20 point IRE</p> <ul style="list-style-type: none"> - Pattern: Inner, Outer - Institute of Radio Engineers (IRE) is the unit indicating the size of a video signal and can be set to 5, 10, 15, ... 100. You can fine-tune for each setting as shown below. - Red/Green/Blue: The adjustment range is -50 - +50. - Apply to all inputs: The values of the White Balance is applied to all the input modes.
Color Management System	<p>Adjusts Red/Green/Blue/Cyan/Magenta/Yellow colors. Allows an expert to adjust the tint using a test pattern. Six colors (Red/Green/Blue/Cyan/Magenta/Yellow) can be selectively adjusted without affecting other colors. You may not see colors change on a normal picture even after adjustment.</p> <ul style="list-style-type: none"> - Saturation Red/Green/Blue/Yellow/Cyan/Magenta, - Tint Red/Green/Blue/Yellow/Cyan/Magenta, - Luminance Red/Green/Blue/Yellow/Cyan/Magenta: <p>The adjustment range is -30 - +30 each.</p>

* Depending on input signal or other picture settings, the range of detailed items for adjustment may differ.

Picture Option

Item	Description	
Noise Reduction	Reduces screen noise in the video.	
MPEG Noise Reduction	Eliminates noise generated while creating digital picture signals.	
Black Level	Adjusts the brightness or darkness of the screen to suit the black level of the picture input using the degree of darkness (black level) of the screen.	
Real Cinema	Optimizes the screen for movie viewing.	
TruMotion	Corrects images to display smoother motion sequences.	
	Mode	
	Smooth	De-Judder value is set to 3.
	Clear	De-Judder value is set to 7.
	User	De-Judder can be set manually. <ul style="list-style-type: none"> • De-Judder: This function adjusts juddering of the screen.
Off	De-Judder value is set to 0.	
Color Temperature	Adjusts the overall color of the screen to suit your preference. You can select Natural , Cool , Medium , or Warm .	
Peak Mode	Adjusts the brightness to the optimal level for the image. <ul style="list-style-type: none"> - If the image is mostly white, the brightness level increases. - If the image mainly consists of red/green/blue/blue green/magenta/yellow colors, you may not see a change in brightness. - Peak Mode is only enabled when Picture Mode is set to Vivid and Energy Saving is set to Minimum. - If Peak Mode is enabled, Energy Saving and Color Temperature are disabled. 	

* If the video signal is 60 Hz, **TruMotion** may not work.

SOUND Settings

- 1 Press the **SETTINGS** button.
(Press the **SMART**  button and select **Settings**.)
- 2 Use the \wedge or \vee button to select **SOUND** and press the **OK** button.
- 3 Use the \wedge , \vee , \lt , or \gt button to set up the desired item and press the **OK** button.
- To return to the previous menu, press the \rightarrow button.

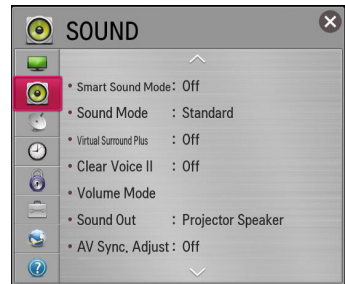

The available sound settings are described as follows.

Item	Description	
Smart Sound Mode	Provides the optimized sound adjusted for each content type. <ul style="list-style-type: none"> • If the Smart Sound Mode function is enabled, Sound Mode, Virtual Surround Plus and Clear Voice II are automatically adjusted. 	
Sound Mode	Sets the sound mode.	
	Mode	
	Standard	Suitable for all types of video.
	Music/ Cinema/ Sport/ Game	Sets audio optimized for a specific genre.
	User Setting	Adjusts volume level. <ul style="list-style-type: none"> • 100 Hz/ 300 Hz/ 1 kHz/ 3 kHz/ 10 kHz: Sets EQ by manual adjustment of sound bands. • Reset: Resets the equalizer value changed by the user.
Virtual Surround Plus	Provides realistic 5.1 channel stereo sound from two speakers. <ul style="list-style-type: none"> • If Clear Voice II is set to ON, Virtual Surround plus will not be chosen. 	
Clear Voice II	Boosts voice clarity.	

Item	Description	
Volume Mode	Sets various modes for volume control.	
	Mode	
	Auto Volume	Sets Auto Volume to On . The volume varies from channel to channel and program to program. When clicking through the channels, the volume is adjusted automatically to maintain the same level.
	Volume Control	Using a single volume curve may result in an inaudible or loud sound depending on the environment. Adjusts volume levels depending on the time of day (day/night).
Sound Out	Sets the audio output of the projector.	
	Mode	
	Projector Speaker	Sound is output through the projector speaker.
	External Speaker (Optical/HDMI ARC)	Sound is output through the speaker connected to the optical port. SIMPLINK is supported. <ul style="list-style-type: none"> • Digital Sound Out: Sets up Digital Sound Output.
	LG Sound Sync (Optical)	Sound is output through an LG audio device connected to the optical digital audio output port.
	LG Sound Sync (Wireless)	Sound is output through a wirelessly connected LG audio device.
	Headphone	Sound is output through headphones. <ul style="list-style-type: none"> • Headphones are detected and connected automatically when the projector is on.

Item	Description	
AV Sync. Adjust	Synchronizes video and audio directly when they do not match. If you set AV Sync. Adjust to ON , you can adjust the sound output (Projector speakers or SPDIF) to the screen image.	
	Mode	
	Projector Speaker	Adjusts the synchronization of the sound from the Projector's internal speakers. The + and - buttons allow the viewer to synchronize the audio with the video.
	External Speaker	Adjusts how the sound is synced to external speakers, such as an external speaker connected to the digital audio output port, LG audio device and headphone. The + and - buttons allow the viewer to synchronize the audio with the video.
Sound Option Setting	Bypass	Outputs broadcasting signals or the audio of an external device without audio delay. Audio may be output before video as it takes time to process video input into the projector.
	Balance: Adjusts left/right audio balance.	

CHANNEL Settings

- 1 Press the **SETTINGS** button.
(Press the **SMART**  button and select **Settings**.)
- 2 Use the \wedge or \vee button to select **CHANNEL** and press the **OK** button.
- 3 Use the \wedge , \vee , \leftarrow , or \rightarrow button to set up the desired item and press the **OK** button.
- To return to the previous menu, press the \rightarrow button.



The available channel settings are described as follows.

Item	Description
Auto Tuning	Remembers a channel which is currently broadcasting. You should use this function when you move to another house or move the projector to other place. It must be used while the antenna is connected and there are channel broadcasting signals. <ul style="list-style-type: none"> • Channels are not registered properly unless the antenna/cable is connected correctly. • Auto Tuning only finds programs that are currently broadcasting. Only finds programs that are currently broadcasting. • If Lock System is turned on, a pop-up window will appear asking for password.
Manual Tuning	Adjusts programs manually and saves the results. For digital broadcasting, signal strength and signal quality can be checked.
Channel Edit	Edits the saved programs. Set as favorite program, block/unblock program, skip program etc. of the selected program.

TIME Settings

- 1 Press the **SETTINGS** button.
(Press the **SMART**  button and select **Settings**.)
- 2 Use the \wedge or \vee button to select **TIME** and press the **OK** button.
- 3 Use the \wedge , \vee , \leftarrow , or \rightarrow button to set up the desired item and press the **OK** button.
- To return to the previous menu, press the \rightarrow button.

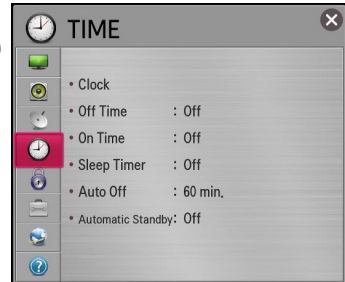

The available time settings are described as follows.

Item	Description			
Clock	Checks or changes the time while watching projector.			
	Mode			
	<table border="1"> <tr> <td>Auto</td> <td>Synchronizes the projector clock to the digital time information sent by the TV station.</td> </tr> <tr> <td>Manual</td> <td>Sets the time and date manually if the auto setup does not correspond to the current time.</td> </tr> </table>	Auto	Synchronizes the projector clock to the digital time information sent by the TV station.	Manual
Auto	Synchronizes the projector clock to the digital time information sent by the TV station.			
Manual	Sets the time and date manually if the auto setup does not correspond to the current time.			
Off Time /On Time	<p>Sets On/Off time. Select Off on Repeat to discontinue On Time/Off Time.</p> <ul style="list-style-type: none"> • To use On Time/Off Time, set the current time correctly. • Even when the On Time function is on, the projector will turn off automatically in 120 minutes when no button is pressed within that time. 			
Sleep Timer	<p>Turns off the projector after a preset number of minutes.</p> <p>To cancel the Sleep Timer, select Off.</p>			
Auto Off	If there is no signal, the projector automatically turns off after the preset time has elapsed.			
Automatic Standby	If you do not press any button on the projector or remote control for a certain period, the projector will automatically turns off.			

LOCK Settings

- 1 Press the **SETTINGS** button.
(Press the **SMART**  button and select **Settings**.)
- 2 Use the \wedge or \vee button to select **LOCK** and press the **OK** button.
- To enter the **LOCK** menu, enter the preset 4-digit password. The initial password is set as **0000**.
- 3 Use the \wedge , \vee , \leftarrow , or \rightarrow button to set up the desired item and press the **OK** button.
- To return to the previous menu, press the \rightarrow button.



The available lock settings are described as follows.

Item	Description	
Set Password	Sets or changes projector password. <ul style="list-style-type: none"> • The initial password is set as 0000. 	
Lock System	Permits only specific programs by blocking channels or external input. Select the Lock System to On .	
	Item	
	Block Channel	Blocks the programs that contain inappropriate contents for children. The programs can be selected but the screen is blank and the audio is muted. To watch a locked program, enter the password.
Movie Rating	Blocks the movies that are only broadcasted on the TV and contain inappropriate contents, based on the Motion Picture Association of America (MPAA) rating. <ul style="list-style-type: none"> • G (General audiences) All ages admitted • PG (Parental guidance suggested) Some material may not be suitable for children • PG-13 (Patents strongly cautioned) Some material may be inappropriate for children under 13 • R (Restricted) Under 17 requires accompanying parent or adult guardian • NC-17 No one 17 and under admitted. • X Adults only 	

Item	Description	
Lock System	Item	
	TV Rating-Children	<p>Blocks the children’s TV programs that parents do not want their children to watch. To block other TV programs, you should set the TV Rating-General feature.</p> <ul style="list-style-type: none"> • Age TV-Y (All children, including children from ages 2-6), TV-Y7 (Directed to older children, suitable for children age 6 and above) • Fantasy Violence TY-Y7 (Directed to older children – Fantasy violence, suitable for children age 6 and above, containing more intense or combative fantasy violence)
	TV Rating-General	<p>Blocks the TV programs that you want based on the ratings by using the Parental Control Function (V-Chip). The V-Chip electronically reads TV program ratings and allows parents to block program that are unsuitable for children.</p> <ul style="list-style-type: none"> • Age TV-G (General audience, suitable for all ages) TV-PG (Parental guidance suggested, containing material that are unsuitable for younger children) TV-14 (Parents strongly cautioned, containing material that are unsuitable for children age 14 and under) TV-MA (Mature audience only, unsuitable for children age 17 and older) • Dialog (suggestive dialogue) TV-PG or TV-14 • Language (coarse language)TV-PG, TV-14, or TV-MA • Sex (sexual situation) TV-PG, TV-14, or TV-MA • Violence TV-PG, TV-14, or TV-MA
	Downloadable Rating	<p>This function operates only when TV has received Region5 Rating data. The name of the rating option may differ.</p>
	Input Block	<p>Block the input sources.</p>
Application Lock	<p>Lock the application.</p>	

OPTION Settings

- 1 Press the **SETTINGS** button.
(Press the **SMART**  button and select **Settings**.)
- 2 Use the \wedge or \vee button to select **OPTION** and press the **OK** button.
- 3 Use the \wedge , \vee , \lt , or \gt button to set up the desired item and press the **OK** button.
- To return to the previous menu, press the \rightarrow button.



The available option settings are described as follows.

Item	Description	
Language	Selects Menu Language and Audio Language displayed on the screen.	
	Item	
	Menu Language	Selects a screen menu language.
	Audio Language	Selects the desired language when watching digital broadcasting containing several audio languages. (In digital mode only)
Voice Recognition Language	Select the language to make voice search.	
Service Country Setting	You can change the country setting of your smart projector. The premium service and LG Smart World that are available for the country you selected will be provided. <ul style="list-style-type: none"> • If a network is disconnected while setting the service country, it may not be set properly. 	
	Item	
	Auto Setting	A service country is automatically set for your smart projector.
	Manual Setting	A service country can be set manually for your smart projector.
ZIP Code	You can check the information of area when network is connected. <ul style="list-style-type: none"> • This function sets your area as the ZIP Code. • You can check the information of area when network is connected. 	

Item	Description	
Caption	View subtitles when the TV station provides subtitled programming. Program subtitles work only on digital/analog broadcasts or external input. Change Caption to On and select caption setting.	
	Mode	<p>CC 1-4 (Closed Captioning) / Text 1-4</p> <p>Displays the audio portion of a TV program as text on the TV screen. CC1 is the most common mode in use.</p> <p>Field 1 data channels: two Captions (CC1, CC2), two Text (T1, T2).</p> <p>Field 2 data channels: two Captions (CC3, CC4), two Text (T3, T4).</p> <p>Service 1-6</p> <p>This is only available for the digital broadcasting system.</p>
	Digital Option	<p>Set up the size and color of the subtitles on Digital Option. Please select Set by Program or Custom.</p> <p>Select Custom to adjust minute options such as the subtitles' size and color.</p>
	Item	
	Size	Selects the wordsize.
	Font	Selects a typeface for the text.
	Text Color	Selects a color for the text.
	Text Opacity	Adjusts the opacity for the text color.
	Bg Color	Selects a color for the background color.
	Bg Opacity	Adjusts the opacity for the background color.
	Edge Type	Selects an edge type.
	Edge Color	Selects a color for the edges.
	Window Color	Selects a color for the window color.
Window Opacity	Adjust the opacity for the window color.	

Item	Description	
Standby Light	Adjusts the LED button indicator.	
	Item	
	On	When the buttons are touched, their indicators are all turned on at maximum brightness. In standby mode, LED indicators are turned on at 20 % of the maximum brightness.
Off	When the buttons are touched, their indicators are all turned on at maximum brightness. In standby mode, all LED indicators are turned off.	
Set the Universal Control	With the magic remote control, you can control a set-top box, blu-ray player, home theatre system, etc.	
Pointer	Sets the speed and shape of the pointer that appears on the Projector screen.	
	Speed	Sets the moving speed of the pointer.
	Shape	Selects a pointer shape from various options.
	Size	Chooses the size of the pointer.
	Alignment	Set to On . If there is any misalignment between the pointer and the actual direction the remote control indicates, move the magic remote control left and right to realign. The pointer will automatically realign to the centre, making it easier to control. <ul style="list-style-type: none"> • If it is set to Off, the alignment function will not work even when you move the magic remote control left and right.
PJT Mode	This function turns the projected image upside down or flips horizontal.	
Auto Keystone	Auto Keystone provides a rectangular screen image by automatically adjusting the Keystone number when there is a trapezoidal screen image caused by tilting of the projector.	
	Item	
	On	Automatically adjusts the Keystone number.
Off	Manually adjusts the Keystone number.	
Keystone	To prevent the screen image from becoming trapezoidal, Keystone adjusts the top and bottom width of the image if the projector is not set at a right angle to the screen.	
Blank Image	Selects a background for blank Image.	

Item	Description			
Auto Power	Makes the projector turn on automatically When the power code is connected to the projector.			
	Item			
	<table border="1"> <tr> <td data-bbox="338 317 502 379">On</td> <td data-bbox="502 317 1018 379">When the power code is connected to the projector, it turns on automatically.</td> </tr> <tr> <td data-bbox="338 379 502 443">Off</td> <td data-bbox="502 379 1018 443">When the power code is connected to the projector, it goes into standby mode.</td> </tr> </table>	On	When the power code is connected to the projector, it turns on automatically.	Off
On	When the power code is connected to the projector, it turns on automatically.			
Off	When the power code is connected to the projector, it goes into standby mode.			
High Altitude	If the projector is used at an altitude higher than 1200 meters (4,000 ft), turn this on. Otherwise, the projector may overheat or its protection function may be activated. If this happens, turn the projector off and then on again after waiting for several minutes.			
Auto Input Search	Automatically searches for and displays the input signal type when it is received. It is available only with external inputs (HDMI, AV, and Component).			
Balloon Help	Enables/disables the balloon help.			
Control Device List	Displays the list of control devices connected to the projector.			
See Avatar	Turns the Avatar function on or off.			
Initial Setting	Deletes all optional settings and returns to initial default mode. Once initialization is complete, the projector will turn off and on by itself. <ul style="list-style-type: none"> • If Lock System is activated, a pop-up password prompt will appear. • Do not turn off the power during initialization. 			
Mode Setting	Selects Home Use or Store Demo . For use at home, select Home Use . Store Demo is a mode used for store display.			

NETWORK Settings

- 1 Press the **SETTINGS** button.
(Press the **SMART**  button and select **Settings**.)
- 2 Use the \wedge or \vee button to select **NETWORK** and press the **OK** button.
- 3 Use the \wedge , \vee , \lt , or \gt button to set up the desired item and press the **OK** button.
- To return to the previous menu, press the \rightarrow button.



The available network settings are described as follows.

Item	Description			
Network Connection	Connects a network.			
Network Status	Displays the connection status of the network.			
Soft AP	This function allows you to change a wired Internet connection to your projector to Wi-Fi, allowing you to connect various external devices or to use wireless Internet.			
	<table border="1" style="width: 100%;"> <tr> <td style="width: 30%;">Soft AP</td> <td>Sets to On/Off.</td> </tr> <tr> <td>Security Key</td> <td> Sets the Wi-Fi security number. <ul style="list-style-type: none"> • You can set the security key with a combination of English letters and numbers between 8 and 64 characters long. • The default setting is "LG123456". </td> </tr> </table> <ul style="list-style-type: none"> • To enable the Soft AP function, your projector must be turned on and have a wired Internet connection. • Up to four external devices can be connected. • If the Soft AP function is enabled, the Wi-Fi Direct and Miracast™ functions become unavailable. You must set the Soft AP function to Off to use the Wi-Fi Direct and Miracast™ functions. 	Soft AP	Sets to On/Off .	Security Key
Soft AP	Sets to On/Off .			
Security Key	Sets the Wi-Fi security number. <ul style="list-style-type: none"> • You can set the security key with a combination of English letters and numbers between 8 and 64 characters long. • The default setting is "LG123456". 			
Wi-Fi Direct	Wi-Fi Direct is a function that allows your projector to connect with a Wi-Fi Direct device without Internet connection.			
Miracast™ / Intel's WiDi	The Miracast™ allows you to enjoy video and audio from a portable device through the projector wirelessly. Intel's WiDi allows you to view a laptop screen through the projector without a cable.			
My Projector Name	Changes the name that appears when searching for the projector from other devices.			

SUPPORT

- 1 Press the **SETTINGS** button.
(Press the **SMART**  button and select **Settings**.)
- 2 Use the \wedge or \vee button to select **SUPPORT** and press the **OK** button.
- 3 Use the \wedge , \vee , \lt , or \gt button to set up the desired item and press the **OK** button.
 - To return to the previous menu, press the \rightarrow button.

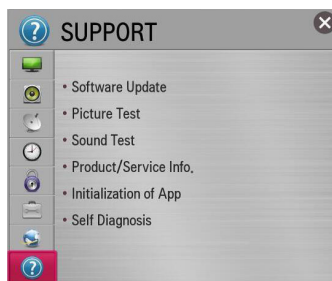

The available support settings are described as follows.

Item	Description
Software Update	Updates to the latest software.
Picture Test	Check whether a video signal is properly displayed.
Sound Test	Check whether an audio signal is properly output.
Product/Service Info.	Shows the product/service information.
Initialization of App	If problems occur after updates, try initializing the system. <ul style="list-style-type: none"> • During initialization, the projector will restart automatically.
Self Diagnosis	Troubleshoots functional problems that can arise while using the product.

CONNECTING DEVICES

You can connect various external devices to the projector.

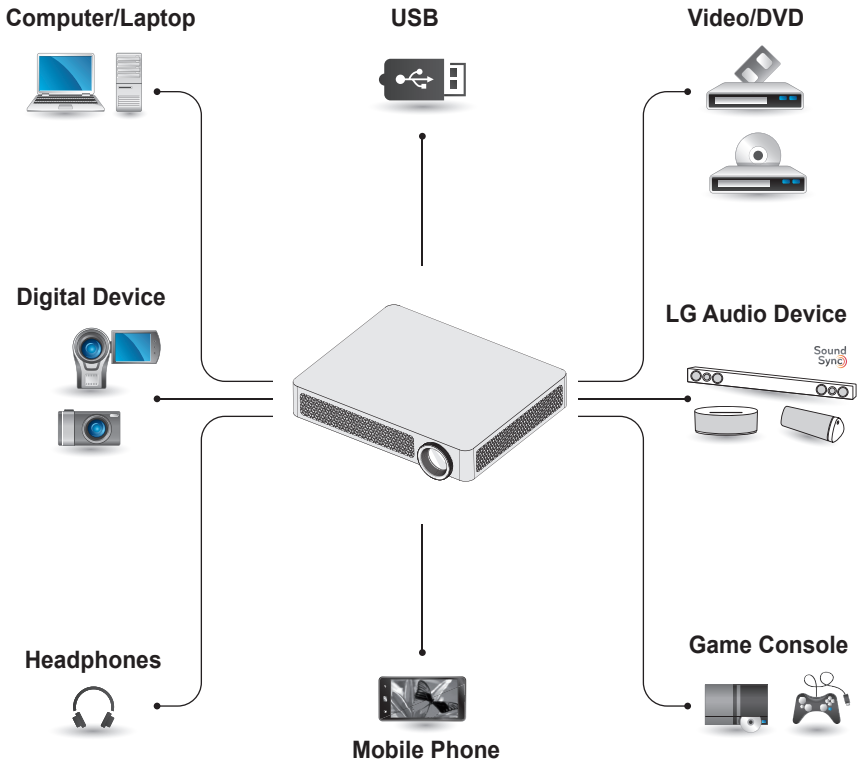

- HDMI - page 102
- Composite (AV) - page 103
- Component - page 104
- USB Devices - page 48
- Headphones - page 107
- Digital Amp - page 108
- Mobile Phone - page 109

Connecting to HD Receiver, DVD, or VCR Player, External Devices

Connect an HD receiver, DVD, VCR player, or external devices to the projector and select an appropriate input mode.

HDMI Connection

With an HDMI cable, you can enjoy high quality picture and sound.

Using a HDMI cable, connect the **HDMI IN 1 (ARC)** port of the projector to the HDMI output port of the device to connect. Both video and audio are output at the same time. You can also use the **HDMI IN 2 (MHL)**.

Press the **INPUT** button on the remote control to select **HDMI**. You can connect with any HDMI input port.

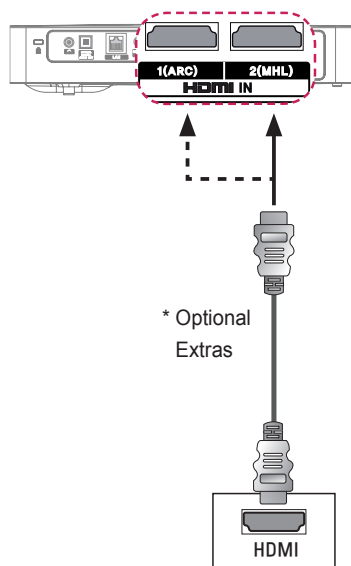

NOTE

ARC(Audio Return Channel)

- External audio devices that support SIMPLINK and ARC must be connected using **HDMI IN 1(ARC)** port.
- When connected with a high-speed HDMI[®] cable, external audio devices that support ARC output or SPDIF work with the SIMPLINK function without the need for an additional optical audio cable.

HDMI to DVI Connection

Using an HDMI to DVI cable, connect the projector's HDMI IN port to the DVI OUT port.

To output audio, use an audio cable for connection.

Press the **INPUT** button on the remote control to select **HDMI**. You can connect with any HDMI input port.

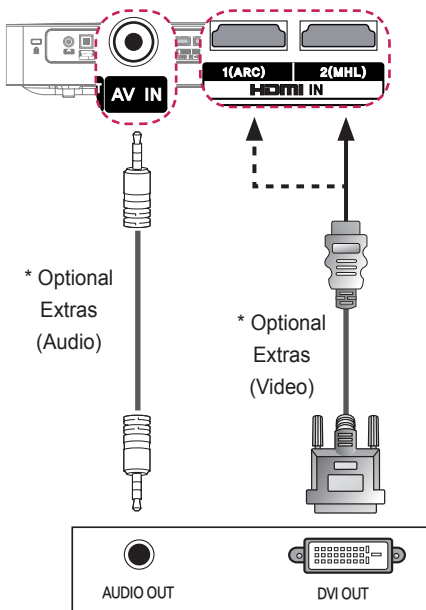

AV Connection

Connect the output ports of an external device and the **AV IN** ports of the projector using an AV cable. Press the **INPUT** button on the remote control to select **AV**.

Check whether cables of the same color are connected properly.

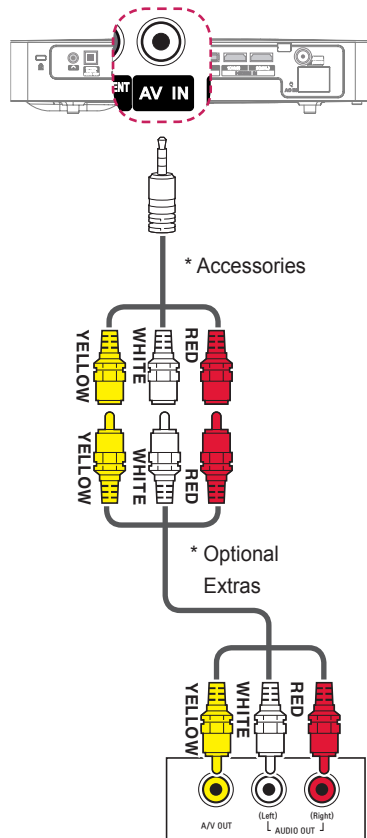

Component Connection

You can enjoy a video by connecting the Component port of an external device to the **COMPONENT IN** port of the projector. Press the **INPUT** button on the remote control to select **Component**. Check whether cables of the same color are connected properly.

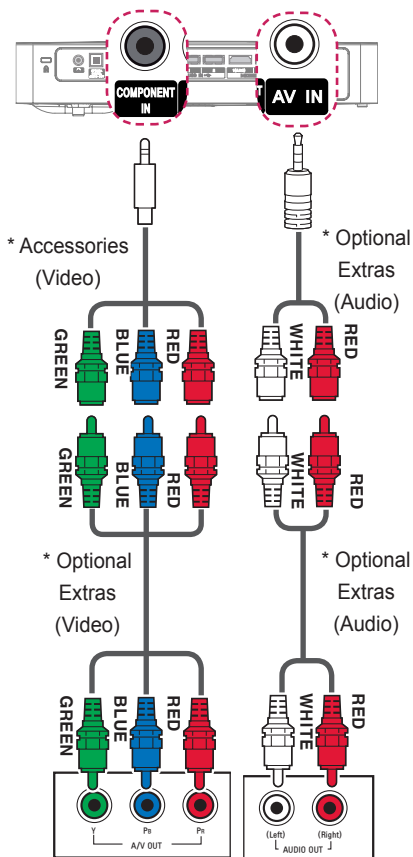

Connecting a PC

The projector supports Plug & Play. Your PC will automatically detect the projector and requires no driver installation.

HDMI Connection

Using an HDMI cable, connect the **HDMI IN 1 (ARC)** port of the projector to the HDMI output port of your PC. Both video and audio are output at the same time. You can also use the **HDMI IN 2 (MHL)**.

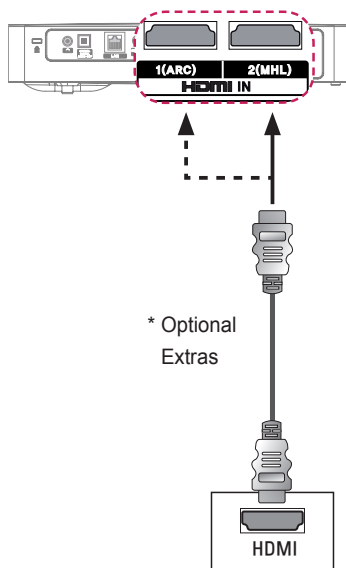

HDMI to DVI Connection

Using an HDMI to DVI cable, connect the projector's HDMI IN port to the DVI OUT port.

To output audio, use an audio cable for connection.

Press the **INPUT** button on the remote control to select **HDMI**. You can connect with any HDMI input port.

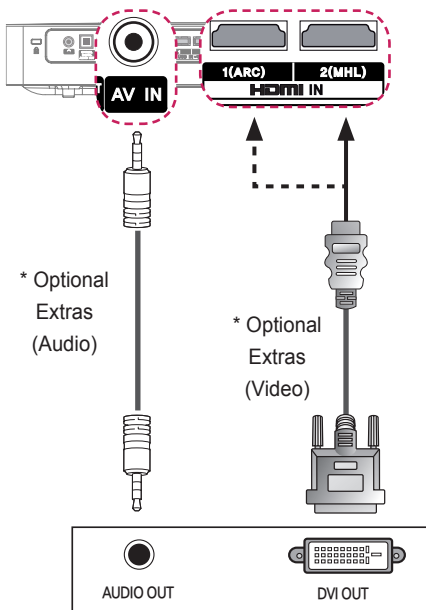

NOTE

- It is recommended to use an HDMI connection for the best image quality.
- Depending on the graphics card, DOS mode video may not work if a HDMI to DVI Cable is in use.
- In PC mode, there may be noise associated with the resolution, vertical pattern, contrast, or brightness. If noise is present, change the PC output to another resolution, change the refresh rate to another rate or adjust the brightness and contrast on the PICTURE menu until the picture is clear.
- The synchronization input form for Horizontal and Vertical frequencies is separate.
- Depending on the graphics card, some resolution settings may not allow the image to be positioned on the screen properly.
- If you are using DVI out from a PC, you have to connect analog audio separately.
- When using the HDMI/DVI cable, Single link only is supported.

Connecting a Laptop

You can connect the projector to a laptop to use various functions.

HDMI Connection

Using an HDMI cable, connect the **HDMI IN 1 (ARC)** port of the projector to the HDMI output port of your laptop. Both video and audio are output at the same time. You can also use the **HDMI IN 2 (MHL)**.

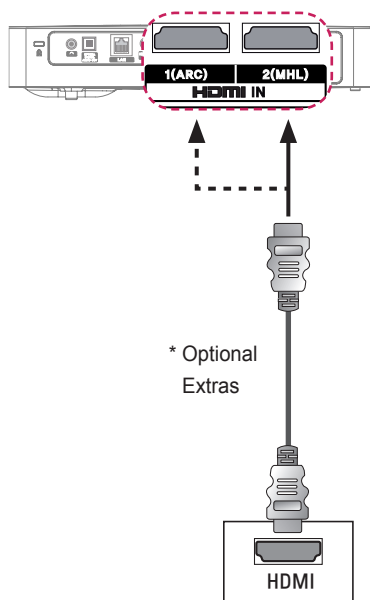

The table below shows examples of switching the output. For more information, refer to the **External Output, Connecting to an External Monitor**, or similar sections of the owner's manual of your computer.

Brand	Switching Output
NEC	Fn + F3
Panasonic	Fn + F3
Toshiba	Fn + F5
IBM	Fn + F7
Sony	Fn + F7
Fujitsu	Fn + F10
LG	Fn + F7
Samsung	Fn + F4
Macintosh	Adjust the control panel to enable mirroring after start-up.

Connecting to Headphones

You can listen to the audio through a headphone.

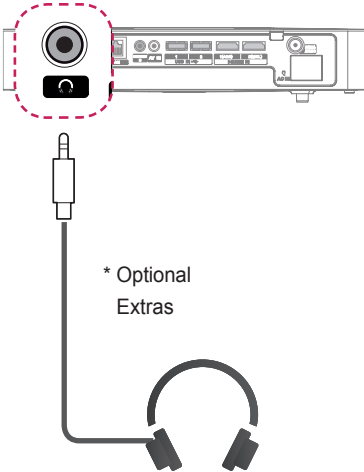

Connecting a Digital Amp

Using an optical cable, connect the digital audio input port of a digital amp to the **OPTICAL DIGITAL AUDIO OUT** port of the projector. The output of an amp with a digital converter must be set to the desired audio format. When using a HDMI cable to connect a home theater or when connecting an optical output to an external audio device, set **Sound Out to External Speaker (Optical/HDMI ARC)** as shown below. If a projector, home theater, or the speaker of an external audio device is operating at the same time, there will be an echo.

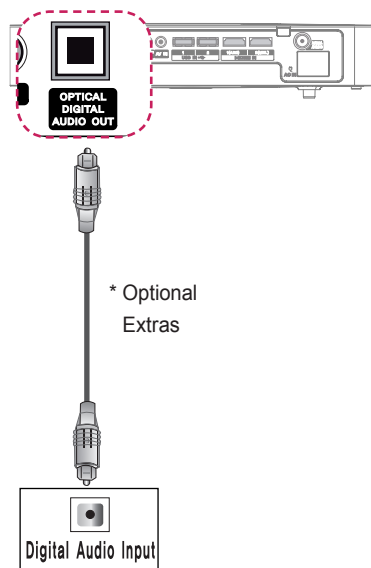

! NOTE

- Also, refer to the user manual of the audio device to connect.
- When connecting this product to other devices, make sure to turn off and unplug all the devices.
- The audio output of this product has wide-ranging audio bandwidth, so the receiver volume must be adjusted properly. Speakers can be damaged by unexpected high frequencies.
- Connecting the **OPTICAL DIGITAL AUDIO OUT** port of the projector to the digital audio input port of a digital amp and the audio input port of the projector to the analog audio output port of the digital amp can cause sound oscillation due to the closed loop. Remove one of the two connections to prevent this. (This also applies to home theater devices.)

Using the Mirroring Function of a Mobile Phone

MHL Connection

The Mobile High-definition Link (MHL) is an interface that can connect a mobile phone to the projector and play video and audio from the mobile phone through the projector.

This only applies to products with a HDMI input that supports MHL.

(To find out whether your device is MHL-certified, please contact your device manufacturer.)

For MHL support, check the **HDMI IN 2 (MHL)** port.

Use a dedicated cable for MHL.

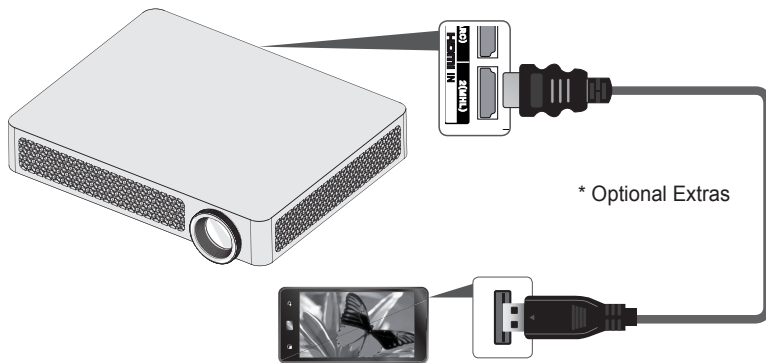

NOTE

- When you connect a mobile phone to the **HDMI IN 2 (MHL)** port, you can see the mobile phone screen through a projector.
 - This only applies to mobile phones that support MHL.
 - You can use the remote control for some applications.
- Disconnect the MHL cable from the projector when:
 - The MHL function is disabled.
 - Your mobile device is fully charged in standby mode.

MAINTENANCE

Clean your Projector to keep it in optimal condition.

Cleaning

Cleaning the Lens

If there is any dust or staining on the lens surface, you must clean the lens.

Use an air spray or a cleaning cloth to clean the lens.

To remove dust or stains, use an air spray or apply a small amount of cleaning agent onto a swab or soft cloth to lightly rub the lens.

Please be aware that liquid may flow into the lens if the product is sprayed directly onto the lens.

Cleaning the Projector Case

To clean the projector case, first unplug the power cord.

To remove dust or stains, use only a dry, lint-free, nonabrasive cloth to polish the lens.

Do not use alcohol, benzene, thinners, or other chemicals, which may damage the case.

INFORMATION

To update projector software

Uses Software Update to check and obtain the latest version.
It is also possible to check manually for available updates.

- 1 Press the **SETTINGS** button.
(Press the **SMART**  button and select **Settings**.)
- 2 Select **SUPPORT** and go to **Software Update**.

Item	Description
Software Update	Set it to On . If an update is available, a prompt will appear to perform the update.
Automatic update mode	If an update is available, the update automatically starts without prompting.
Check Update Version	Checks the latest update version installed. When a new update is available, the download process can be performed manually.

- When the update starts, the update progress window appears for a short time and disappears.
- The latest version can be obtained via the digital broadcast signal or an internet connection.
- If software is not updated, certain functions may not work properly.

Before reporting a problem, check the following:

If the following symptoms occur, please carry out the checks and adjustments described below. There may be no malfunction.

General

Problem	Solution
Cannot view certain programs.	<ul style="list-style-type: none"> Adjust the location or orientation of the antenna. Save the programmes you wish to view later using Auto Tuning or Channel Edit.
There is a delay after the projector is switched on before the image is fully visible.	<ul style="list-style-type: none"> This is not a problem. Image noise that may occur when the projector is first switched on is being cleaned up.

Picture

- SMART**  → **Settings** → **SUPPORT** → **Picture Test**

First run a Picture Test to verify that the image signal output is normal.

If there is no problem with the test image, check external device connections and broadcast signals.

Problem	Solution
Images from previous program or other programs linger or the screen displays annoying lines.	<ul style="list-style-type: none"> Adjust the orientation of the antenna to the TV transmitter, or refer to the manual for instructions on connecting the antenna.
Vibrating horizontal/vertical lines and fishnet patterns appear momentarily.	<ul style="list-style-type: none"> Such a problem may happen when there is strong electronic interference. Turn off other electronic devices such as mobile phones, power tools, and other small electrical appliances.
The screen display freezes or does not work properly during a digital broadcast.	<ul style="list-style-type: none"> This may occur in case of a weak signal or unstable reception. Adjust the antenna orientation and cable connections. If the signal strength or quality is low on Manual Tuning, check with the TV station or administration office.

Problem	Solution
Digital broadcasting is not available even though the cable is connected.	<ul style="list-style-type: none"> • Check with the cable operator providing your subscription and/or signal. (Depending on your subscription, digital broadcasting may not be supported.)
The display is inactive or unclear when connected to an HDMI® source.	<ul style="list-style-type: none"> • Check the HDMI® cable specifications. If your HDMI® cable is not genuine, images may fade in and out or not be displayed properly. • Ensure that all cables are securely connected. When connections are not secure, images may not be properly displayed.
Does not work with a USB storage device.	<ul style="list-style-type: none"> • Verify that the USB device and cable is version 2.0 or higher.

Sound

- **SMART**  → **Settings** → **SUPPORT** → **Sound Test**

First run a Sound Test to verify that the sound signal output is normal.

If there is no problem with the test sound, check connected external devices and the broadcast signal.

Problem	Solution
Screen display is on but there is no sound.	<ul style="list-style-type: none"> • Check other TV programs. • Check if the audio output settings for the projector are configured correctly.
For an analogue broadcast, stereo is not clear or sound comes from one speaker only.	<ul style="list-style-type: none"> • In a poor reception area (areas with weak or unstable signals) or if multi audio is not stable, select Mono on Multi Audio. • Adjust the balance using the navigation button.
TV sound is not in sync with the image or the sound breaks up occasionally.	<ul style="list-style-type: none"> • If the issue affects a specific TV program only, it may be caused by problems with the broadcast signal for the individual station. Check with the TV station or your cable operator.
The volume changes when I change program.	<ul style="list-style-type: none"> • Volume can vary from program to program. • Set Auto Volume to On.

Problem	Solution
<p>On certain programmes, there is no sound at all, or only the background music can be heard (in case of a programs created for overseas viewers).</p>	<ul style="list-style-type: none"> • In Language, set Language → Audio Language to the language of your choice. Even if you change the language on Multi Audio, you can go back to the default setup once you turn off the power or change the programme.
<p>There is no sound when connected to HDMI / USB.</p>	<ul style="list-style-type: none"> • Verify that the HDMI® cable is high speed. • Check if the USB device and cable is version 2.0 or higher. • Use only regular music (*.mp3) files.

PC connection problem

Problem	Solution
<p>The screen display does not come on after connecting to the computer.</p>	<ul style="list-style-type: none"> • Verify that the computer and the projector are securely connected. • Turn the projector off and back on using the remote control. • Restart the PC with the projector on. • Check whether the resolution is correctly set for PC input. • Reconnect the HDMI cable.
<p>There is no sound after connecting the computer with the HDMI cable.</p>	<ul style="list-style-type: none"> • Check with manufacturer of your video card to ensure it supports HDMI voice output. (Video cards in DVI format require connection of a separate sound cable.)
<p>When connected to the computer, the display is partially cut off or shifts to one side.</p>	<ul style="list-style-type: none"> • Set the resolution to support PC input. (If this does not work, reboot the computer.)

Problems Replaying Movies in My Media

Problem	Solution
I cannot view the files on the Movie List.	<ul style="list-style-type: none"> • Check whether the file on the USB storage device can be read on a computer. • Check whether the file extension is supported.
This file is invalid. message appears or the image display is not normal even though the sound is OK.	<ul style="list-style-type: none"> • Make sure that the file replays normally on the computer's video player. (Check for damaged files.) • Check whether the resolution is supported by the computer. • Verify that the video/audio codec is supported. • Verify that the frame rate is supported.
Audio not supported. message appears or the sound is not normal even though the image display is OK.	<ul style="list-style-type: none"> • Make sure that the file replays normally on the computer's video player. (Check for damaged files.) • Check if the audio codec is supported by the computer. • Verify that the bit rate is supported. • Verify that the sample rate is supported.
Subtitles are not displayed.	<ul style="list-style-type: none"> • Make sure that the file replays normally on the computer's video player. (Check for damaged files.) • Check if the video file has the same name as the subtitle file. • Make sure that the video and subtitle files are in the same folder. • Verify that the subtitle file format is supported. • Verify that the subtitle language is supported. (Subtitle files can be opened in Notepad to check the language.)

- Image shown may differ from your projector.
- For information on requesting service, refer to the following menu.

SMART  → **Settings** → **SUPPORT** → **Product/Service Info.**

SPECIFICATIONS

Model	PF85U (PF85U-JE)	
Resolution (Pixel)	1920 (Horizontal) × 1080 (Vertical)	
Aspect ratio	16:9 (Horizontal:Vertical)	
Panel size (mm)	16.654	
Projection distance (Video size)	0.63 m - 3.72 m (50.8 cm - 304.8 cm) 24.8 inches - 146.4 inches (20 inches - 120 inches)	
Ratio of upward projection	100 %	
Working range of the remote control	6 m (236.2 inches)	
POWER	AC 100 ~ 240 V, 50 Hz/ 60 Hz	
Audio output	5 W + 5 W	
Reception type	NTSC-M, ATSC	
Reception channels	VHF : 02 - 13, UHF 14 - 69, CATV 01 - 135, DTV 02 - 69, CADTV 01 - 135	
External Antenna Impedance	75 Ω	
Height (mm)	Min. 45.9 (without foot) (1.8 inches), Max. 55.3 (without foot) (2.1 inches), 56.9 (with foot) (2.2 inches)	
Width (mm)	275.0 (10.8 inches)	
Depth (mm)	219.0 (without lens) (8.6 inches), 226.0 (with lens) (8.8 inches)	
Weight (g)	2200 (4.8 lbs)	
USB Device	5 V, 0.5 A (Max.)	
Operation environment	Temperature	
	Operation	0 °C - 40 °C (32 °F - 104 °F)
	Storage	-20 °C - 60 °C (-4 °F - 140 °F)
	Relative humidity	
	Operation	0 % - 80 %
	Storage	0 % - 85 %

* Contents in this manual may be changed without prior notice due to upgrade of product functions.

HDMI(DTV) supported mode

Resolution	Horizontal Frequency (kHz)	Vertical Frequency (Hz)
720 x 480	31.469	59.94
	31.50	60.00
1280 x 720	44.96	59.94
	45.00	60.00
1920 x 1080	33.72	59.94
	33.75	60.00
	26.97	23.97
	27.000	24.000
	33.716	29.976
	33.75	30.00
	67.43	59.94
67.500	60	

HDMI (PC) supported mode

Resolution	Horizontal Frequency (kHz)	Vertical Frequency (Hz)
640 x 480	31.469	59.94
800 x 600	37.879	60.31
1024 x 768	48.363	60.00
1152 x 864	54.348	60.053
1360 x 768	47.712	60.015
1280 x 1024	63.981	60.020
1920 x 1080	67.5	60.00

- If an invalid signal is input into the product, it will not be displayed properly on the screen or a message such as **No Signal** or **Invalid Format** will be displayed.
- The product supports the DDC1/2B type as the Plug & Play function (Auto-recognition of PC monitor).
- 1920 x 1080 is recommended as the best picture quality in the PC mode.

Component supported mode

Resolution	Horizontal Frequency (kHz)	Vertical Frequency (Hz)
720 x 480i	15.73	59.94
	15.75	60.00
720 x 480p	31.47	59.94
	31.50	60
1280 x 720p	44.96	59.94
	45.00	60.00
1920 x 1080i	33.72	59.94
	33.75	60.00
1920 x 1080p	26.97	23.976
	27.00	24.00
	33.71	29.97
	33.75	30.00
	67.432	59.94
67.500	60.00	

Component port Connecting**information**

Component ports on the TV	Y	PB	PR
Video output ports on DVD player	Y	PB	PR
	Y	B-Y	R-Y
	Y	Cb	Cr
	Y	Pb	Pr

Open Source Software Information

To obtain the source code under GPL, LGPL, MPL and other open source licenses, that is contained in this product, please visit <http://opensource.lge.com>. In addition to the source code, all referred license terms, warranty disclaimers and copyright notices are available for download.

LG Electronics will also provide open source code to you on CD-ROM for a charge covering the cost of performing such distribution (such as the cost of media, shipping and handling) upon email request to opensource@lge.com. This offer is valid for three (3) years from the date on which you purchased the product.

