



Zoom Bullet Camera

Hardware Manual

A416, A418

2021/01/26



Table of Contents

Precautions 4

Safety Instructions	6
---------------------------	---

Introduction 7

List of Models.....	7
Package Contents.....	8
Physical Description	9

Installation Procedures 10

Step 1: Install the Camera.....	10
Step 2: Waterproof the Ethernet Cable	12
Using the Cable Gland.....	12
Step 3: Connect to Network.....	15
Step 4: Access the Camera Live View.....	15

Other Connections 16

Connecting a Power Adapter (Optional)	16
Connecting Digital Input / Output Devices (Optional)	17
Connecting Audio Devices (Optional).....	19

Other Accessories 20

How to Install / Remove the Memory Card	20
---	----

Accessing the Camera 21

Configure the IP Addresses	21
Using DHCP Server to Assign IP Addresses.....	21
Using the Default Camera IP Address.....	23
Access the Camera.....	25

Precautions

Read these instructions

Read all the safety and operating instructions before using this product.

Heed all warnings

Adhere to all the warnings on the product and in the instruction manual. Failure to follow the safety instructions given may directly endanger people, cause damage to the system or to other equipment.

Servicing

Do not attempt to service this product yourself as opening or removing covers may expose you to dangerous voltage or other hazards. Refer all servicing to qualified service personnel.

Trademarks

ACTi and ACTi logo are registered trademarks of ACTi Corporation. All other names and products used in this manual are registered trademarks of their respective companies.

Liability

Every reasonable care has been taken during the writing of this manual. Please inform your local office if you find any inaccuracies or omissions. ACTi will not be held responsible for any typographical or technical errors and reserves the right to make changes to the product and manuals without prior notice.

Federal Communications Commission Statement

This equipment has been tested and found to comply with the limits for a class B digital device, pursuant to Part 15 of the FCC Rules. These limits are designed to provide reasonable protection against harmful interference in a residential installation. This equipment generates, uses, and can radiate radio frequency energy and, if not installed and used in accordance with the instructions, may cause harmful interference to radio communications. However, there is no guarantee that interference will not occur in a particular installation. If this equipment does cause harmful interference to radio or television reception, which can be determined by turning the equipment off and on, the user is encouraged to try to correct the interference by one or more of the following measures:

- Reorient or relocate the receiving antenna.
- Increase the separation between the equipment and receiver.
- Connect the equipment into an outlet on a circuit different from that to which the receiver is connected.
- Consult the dealer or an experienced radio/TV technician for help.

Warning: Changes or modifications to the equipment that are not expressly approved by the responsible party for compliance could void the user's authority to operate the equipment.

European Community Compliance Statement

This product has been tested and found to comply with the limits for Class B Information Technology Equipment according to European Standard EN 55022 and EN 55024. In a domestic environment, this product may cause radio interference in which cause the user may be required to take adequate measures.

Safety Instructions

Cleaning

Disconnect this product from the power supply before cleaning.

Accessories and Repair Parts

Use only the accessories and repair parts recommended by the manufacturer. Using other attachments not recommended by the manufacturer may cause hazards.

Water and Moisture

Install other devices (such as PoE injector, alarm, etc.) that will be used with the camera in a dry place protected from weather.

Servicing

Do not attempt to service this product yourself. Refer all servicing to qualified service personnel.

Damage Requiring service

Disconnect this product from the power supply immediately and refer servicing to qualified service personnel under the following conditions.

- 1) When the power-supply cord or plug is damaged
- 2) If liquid has been spilled, or objects have fallen into the product.
- 3) If the inner parts of product have been directly exposed to rain or water.
- 4) If the product does not operate normally even by following the operating instructions in this manual. Adjust only those controls that are covered by the instruction manual, as improper adjustment of other controls may result in damage, and will often require extensive work by a qualified technician to restore the product to its normal operation.



Safety Check

Upon completion of any service or repairs to this product, ask the service technician to perform safety checks to determine if the product is in proper operating condition.





Introduction

List of Models

This hardware manual contains the following models:

A416		4MP Zoom Bullet with D/N, Adaptive IR, Extreme WDR, SLLS, 5x Zoom Lens
A418		6MP Zoom Bullet with D/N, Adaptive IR, Superior WDR, SLLS, 5x Zoom Lens

Package Contents

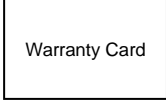
Camera	Mounting Screw Kit	Cable Gland with Washer
		
Wrench	Drill Template	Quick Guide & Warranty Card
		

Physical Description



Item		Description
1	Ethernet Port	Connects to a network using a standard Ethernet cable.
2	Digital Input/ Output	Connects to digital input and output device, such as an alarm trigger, panic button, LED light, etc.
3	Audio Input / Output	Connects to an audio input and output device, such as a microphone and speaker.
4	DC 12V Power	Connects to an external DC 12V power adapter.
5	Reset Button	Press and hold the reset button to restore the camera factory default settings.
6	Analog Video Output	Connects to a video output device, such as a camera installation kit or monitor for testing. Use the bundled video output connector to connect to an external monitor. This connection is used for installation only.
7	Memory Card Slot	Insert a memory card into the slot for local recording.

Installation Procedures

Step 1: Install the Camera

1. Mark the screw holes or attach the bundled drill template on the target surface.
NOTE: Depending on the surface where you will install the camera, it may be necessary to drill four (4) holes and use the supplied screw tox.
2. **If the cable will pass through the surface**, drill the cable hole as indicated on the drill template. **If the cable will be routed along the surface**, route the cable through the gap on the bracket. For outdoor installations, you may need to purchase the optional junction box to protect the cables, contact ACTi Sales for details.
3. Mount the camera to the surface using four (4) screws.

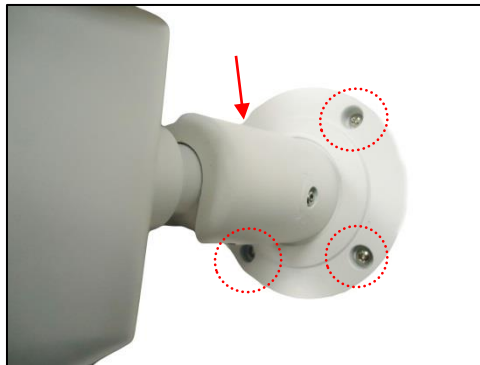

4. Loosen the screw to tilt, pan, or adjust the camera orientation.

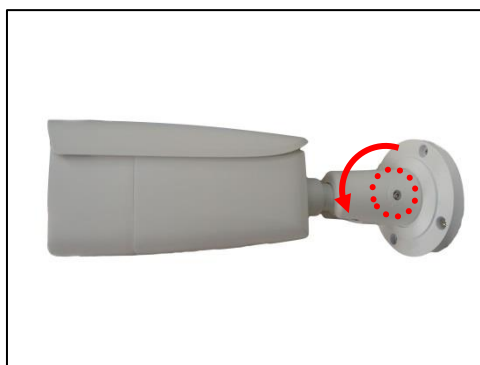

5. Adjust the camera angle and orientation.



Sample of Wall Installation

or

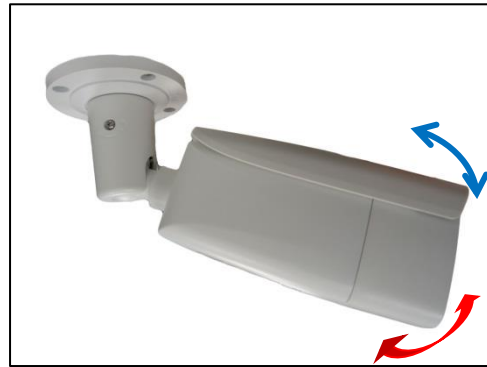

Sample of Ceiling Installation

6. Tighten the screw to fix the tilt angle position.



Step 2: Waterproof the Ethernet Cable

If the camera will be installed outdoors, ensure that the cable connections and the network side cable itself are protected from water and other environmental factors.

Use the bundled cable gland for the Ethernet connector and use waterproof tape to protect the other cable connection. An optional Junction Box is available for purchase, contact ACTi sales for details.

Using the Cable Gland

This section describes how to waterproof the cable-out or “pigtail” of the camera using the bundled cable gland.

Perform the following to waterproof the “pigtail” using the cable gland:

1. Attach the washer to the Ethernet connector of the camera.

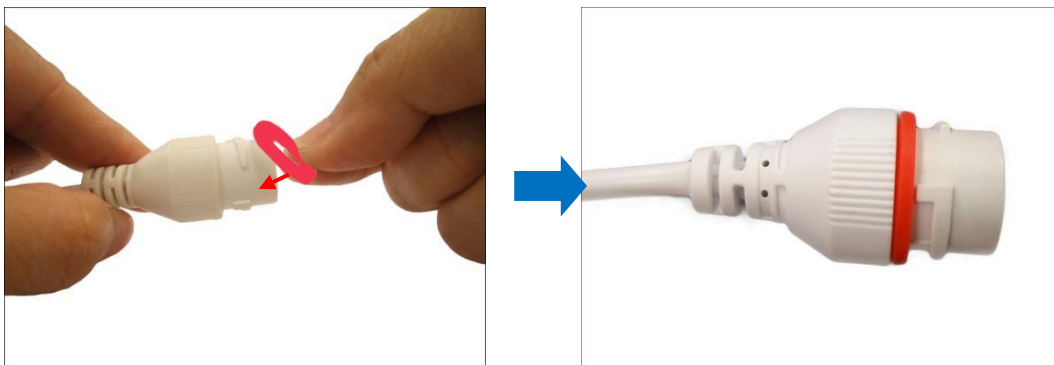

2. Detach the clamping nut and sealing insert from the gland body:

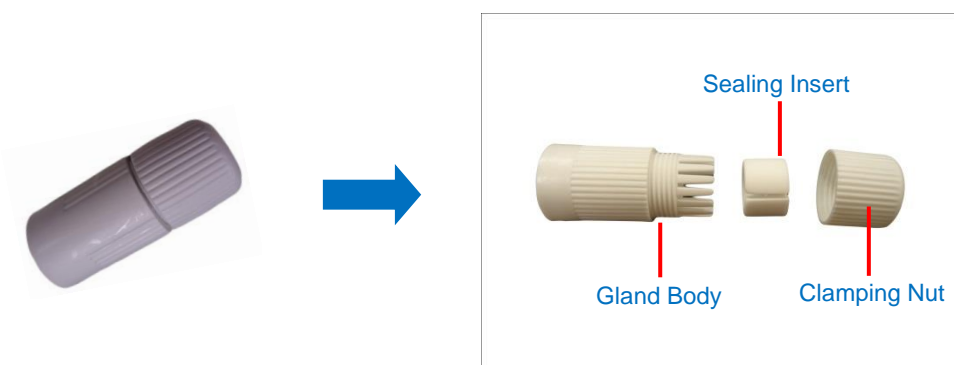

3. Insert the clamping nut into the Ethernet cable.



4. Insert the sealing insert through the Ethernet cable.



5. Insert the cable through the gland body.

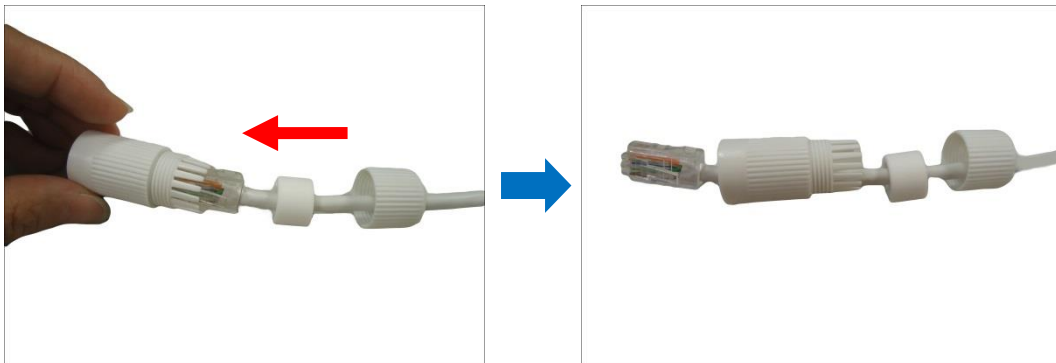

6. Push the sealing insert into the gland body.

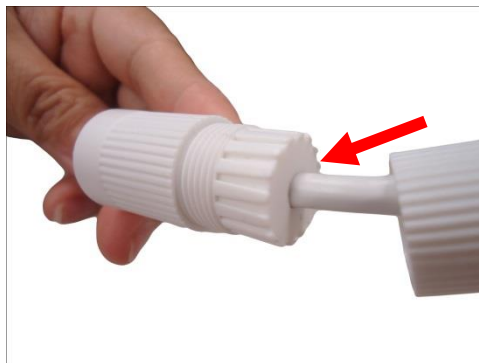

7. Connect the RJ-45 connector to the camera connector.

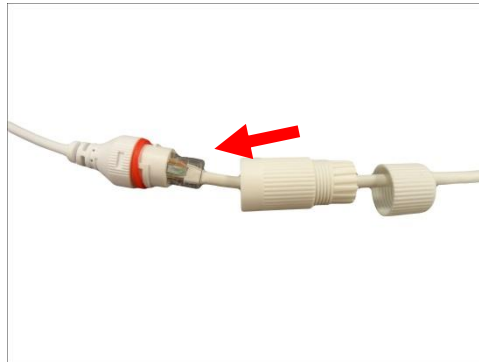

8. Attach the gland body to the camera connector.

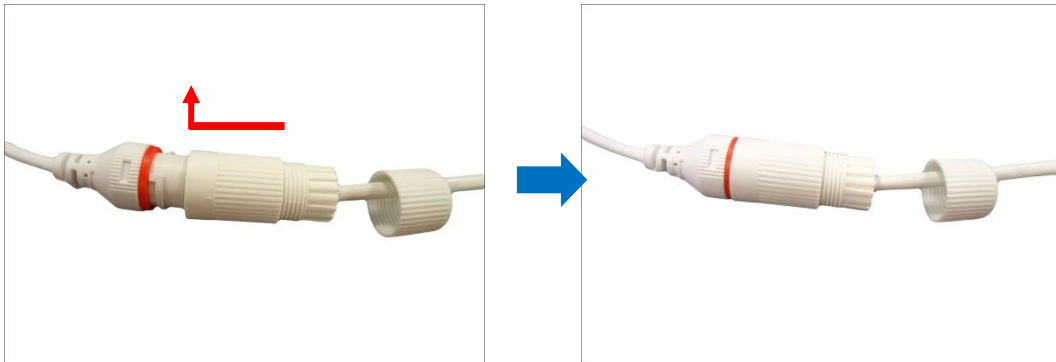

9. Attach the clamping nut to the gland body to complete the cable solution.

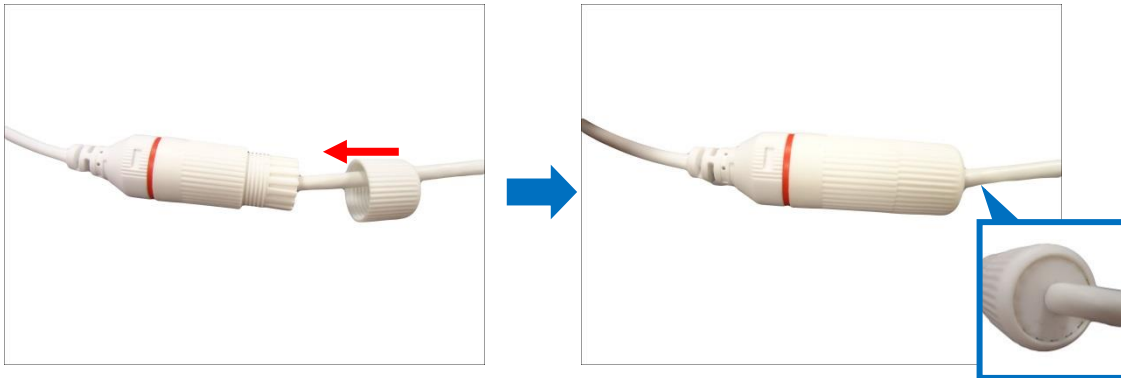

NOTE: Make sure the clamping nut is tightly attached to the cable gland body and the sealing insert is squeezed tightly.

Step 3: Connect to Network

Connect the other end of the network cable to a PoE switch or injector. Then, connect the switch or injector to a network, PC, and a power source. See Power-over-Ethernet (PoE) connection example below.

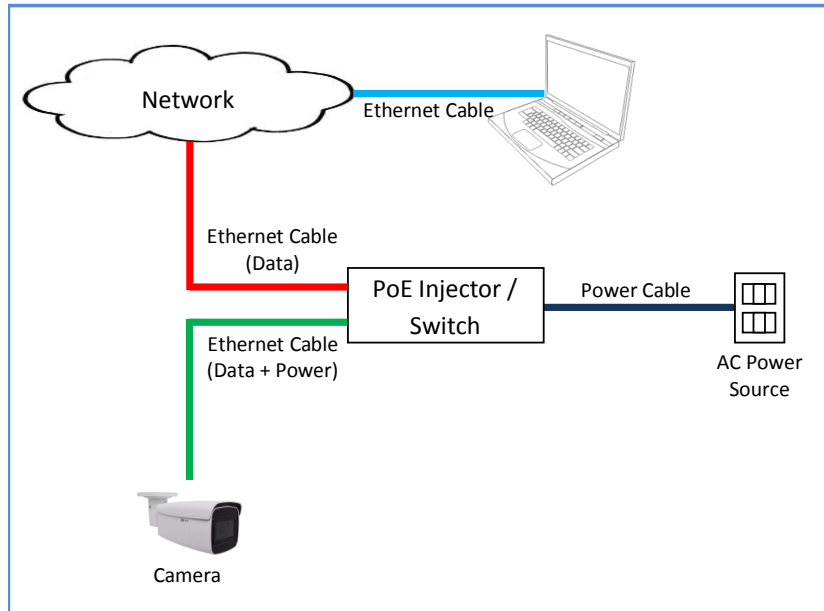

Step 4: Access the Camera Live View

After making the connections, access the camera live view to adjust the viewing angle of the camera and configure the settings according to your preference. See [Accessing the Camera](#) on page 21 for more information.

Other Connections

This section describes the procedures in preparing the external devices that you can connect to the camera. The camera supports DC12V power input, Digital Input and Output (DI/DO) and Audio Input and Output devices. The use of these devices, however, is optional.



Connecting a Power Adapter (Optional)

The camera can be powered by a Power over Ethernet (PoE) switch that is IEEE802.3af compliant. In case of using a non-PoE switch or your PoE switch has a limited power supply, you can purchase a power adapter and directly connect the camera to a power outlet.

NOTE: The power adapter is not bundled in the package.

After connecting the power adapter, waterproof the cable connection by using waterproof tape.

Connecting Digital Input / Output Devices (Optional)

Depending on your needs, you may connect digital input or output devices to your camera, such as alarm, panic button, lights, etc. The camera comes with the terminal block which is already connected to the ALARM cable connector.

Digital Input (DI) devices can be used to notify the camera about an activity in the camera site. DI can be triggers of events. For example, you can connect a “panic button” to the camera; as such when the panic button is pressed, the alarm signal will be sent through the camera. Other common DI device applications are emergency button, smoke detector, passive infrared sensor, etc.

Digital Output (DO) devices are external devices that are activated by the camera upon an event inside the camera. For example, you can connect an “alarm horn” to the camera; as such when an event occurs inside the camera (e.g. detected intruder), the alarm horn will sound. Other common DO device applications are motion-triggered lights, electric fence, magnetic door locks, etc.

Loosen the screw and insert the wire through the pin slot, then tighten the screw to secure the wire.



To connect the digital input / output devices, map the pins to the corresponding pin combinations:

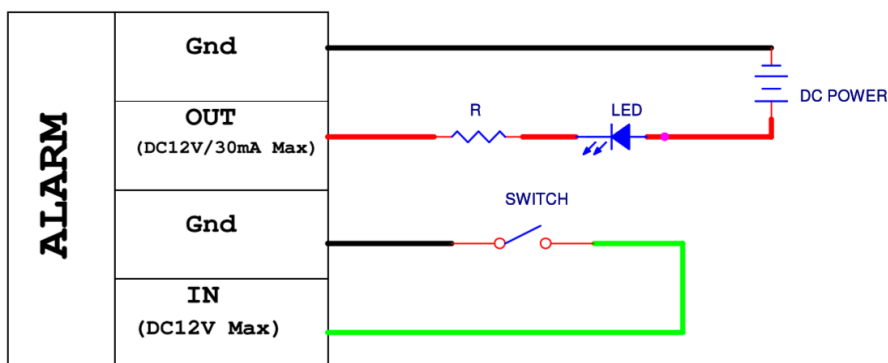

The table below shows the DI/DO connection specifications:

Device			
DI (Alarm IN)	Connection design		TTL - compatible logic levels
	Voltage	To trigger (low)	Logic level 0: 0V ~ 0.4V
		To trigger (high)	Logic level 1: 3.1V ~ 12V
DO (Alarm OUT)	Connection design		Transistor (Open Collector)
	Voltage & Current		< 12V DC, < 30mA

The camera does not provide power for DO devices, make sure to use external power source to power them up. Note the maximum voltage and current allowed on the table above.

After mapping the wires to the terminal block, connect the terminal block to the DIO connector of the camera and make sure to protect the cable connection against water or other environmental factors, such as by using a waterproof tape.

NOTE: For more information on DI/DO connections, please refer to the Knowledge Base article [All About Digital Input and Digital Output](#) downloadable from the link below (<http://Download.acti.com?id=516>).

Connecting Audio Devices (Optional)

Audio input / output devices, such as an active microphone or speaker can be connected to the camera using the supplied terminal block which is already connected to the AUDIO cable connector.

Loosen the screw and insert the wire through the pin slot, then tighten the screw to secure the wire.



To connect audio devices, map the pins to one of the pin combinations below:

Device	Pin	Mapping Instructions
Audio Output (OUT)	OUT	Connect the wires of the audio output device to OUT and G (Ground).
	G	
Audio Input (IN)	IN	Connect the wires of the audio input device to IN and G (Ground).
	G	

The camera does not provide power for external devices. Use an external power source to supply power when using LINE-IN microphones with the camera.

NOTE: For more information about AUDIO in connections, please refer to the Knowledge Base article [How to Use Audio-In of ACTi Cameras](https://Download.acti.com?id=534), downloadable from the link below (<https://Download.acti.com?id=534>).

After mapping the wires to the terminal block, connect the terminal block to the Audio connector of the camera and make sure to protect the cable connection against water or other environmental factors, such as by using a waterproof tape.

DISCLAIMER: ACTi will not be responsible for camera damage due to water leakage caused by improper waterproofing of cables.

Other Accessories

How to Install / Remove the Memory Card

1. Using the bundled wrench, loosen the two (2) screws to remove the cover.



2. Push the microSD card into the memory card slot with the metal contacts facing the lens.

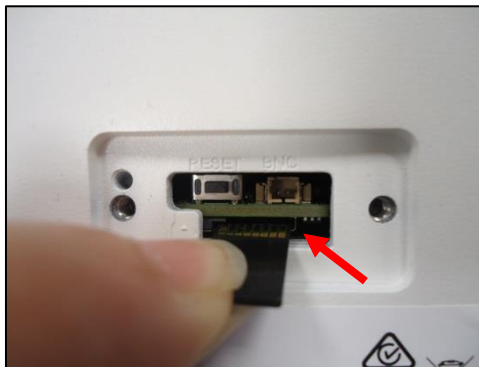

3. Secure the two (2) screws to attach the cover. Make sure the rubber on the cover is in place.



Accessing the Camera

Configure the IP Addresses

In order to be able to communicate with the camera from your PC, both the camera and the PC have to be within the same network segment. In most cases, it means that they both should have very similar IP addresses, where only the last number of the IP address is different from each other. There are 2 different approaches to IP Address management in Local Area Networks – by DHCP Server or Manually.

Using DHCP Server to Assign IP Addresses

If you have connected the computer and the camera into the network that has a DHCP server running, then you do not need to configure the IP addresses at all – both the camera and the PC would request a unique IP address from DHCP server automatically. In such case, the camera will immediately be ready for the access from the PC. The user, however, might not know the IP address of the camera yet. It is necessary to know the IP address of the camera in order to be able to access it by using a Web browser.

The quickest way to discover the cameras in the network is to use the simplest network search, built in the Windows system – just by pressing the “Network” icon, all the cameras of the local area network will be discovered by Windows thanks to the UPnP function support of our cameras.

In the example below, we successfully found the camera model that we had just connected to the network.

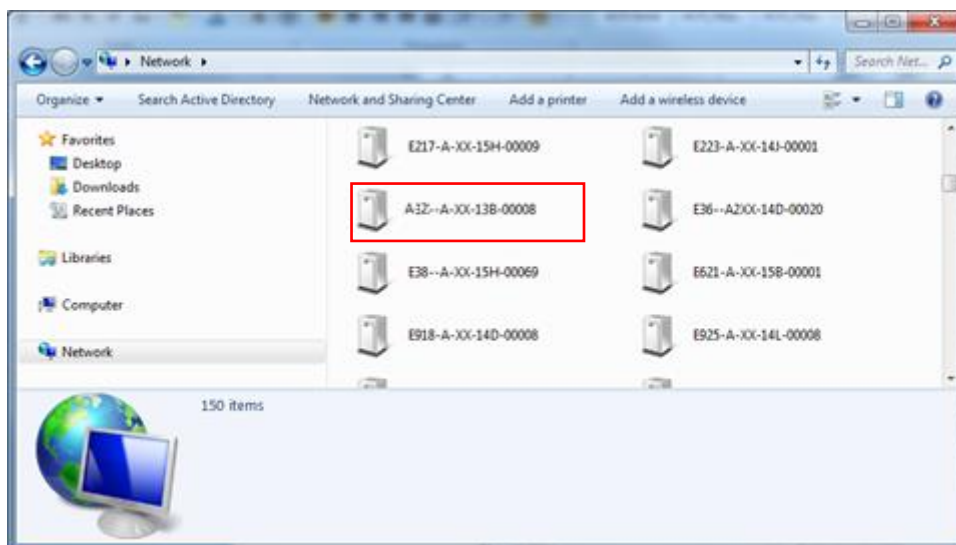

By double-clicking with the left mouse on the camera model, it is possible to automatically launch the default browser of the PC with the IP address of the target camera filled in the address bar of the browser already.

If you work with our cameras regularly, then **there is even a better way to discover the cameras in the network** – by using **IP Utility**. The IP Utility is a light software tool that can not only discover the cameras, but also list lots of valuable information, such as IP and MAC addresses, serial numbers, firmware versions, etc, and allows quick configuration of multiple devices at the same time.

The IP Utility can be downloaded for free from http://www.acti.com/IP_Utility

With just one click, you can launch the IP Utility and there will be an instant report as follows:

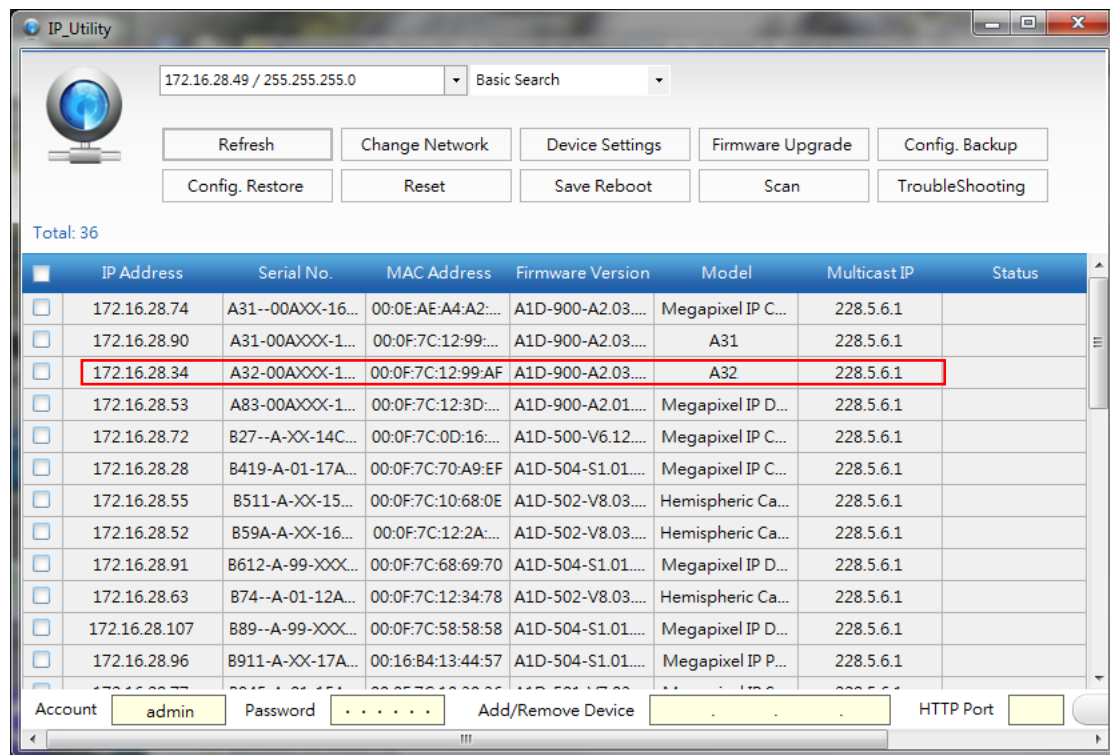

You can quickly see the camera model in the list. Click on the IP address to automatically launch the default browser of the PC with the IP address of the target camera filled in the address bar of the browser already.

Using the Default Camera IP Address

If there is no DHCP server in the given network, the user may have to assign the IP addresses to both PC and camera manually to make sure they are in the same network segment.

When the camera is plugged into network and it does not detect any DHCP services, it will automatically assign itself a default IP:

192.168.0.100

Whereas the default port number would be **80**. In order to access that camera, the IP address of the PC has to be configured to match the network segment of the camera.

Manually adjust the IP address of the PC:

In the following example, based on Windows 7, we will configure the IP address to **192.168.0.99** and set Subnet Mask to **255.255.255.0** by using the steps below:

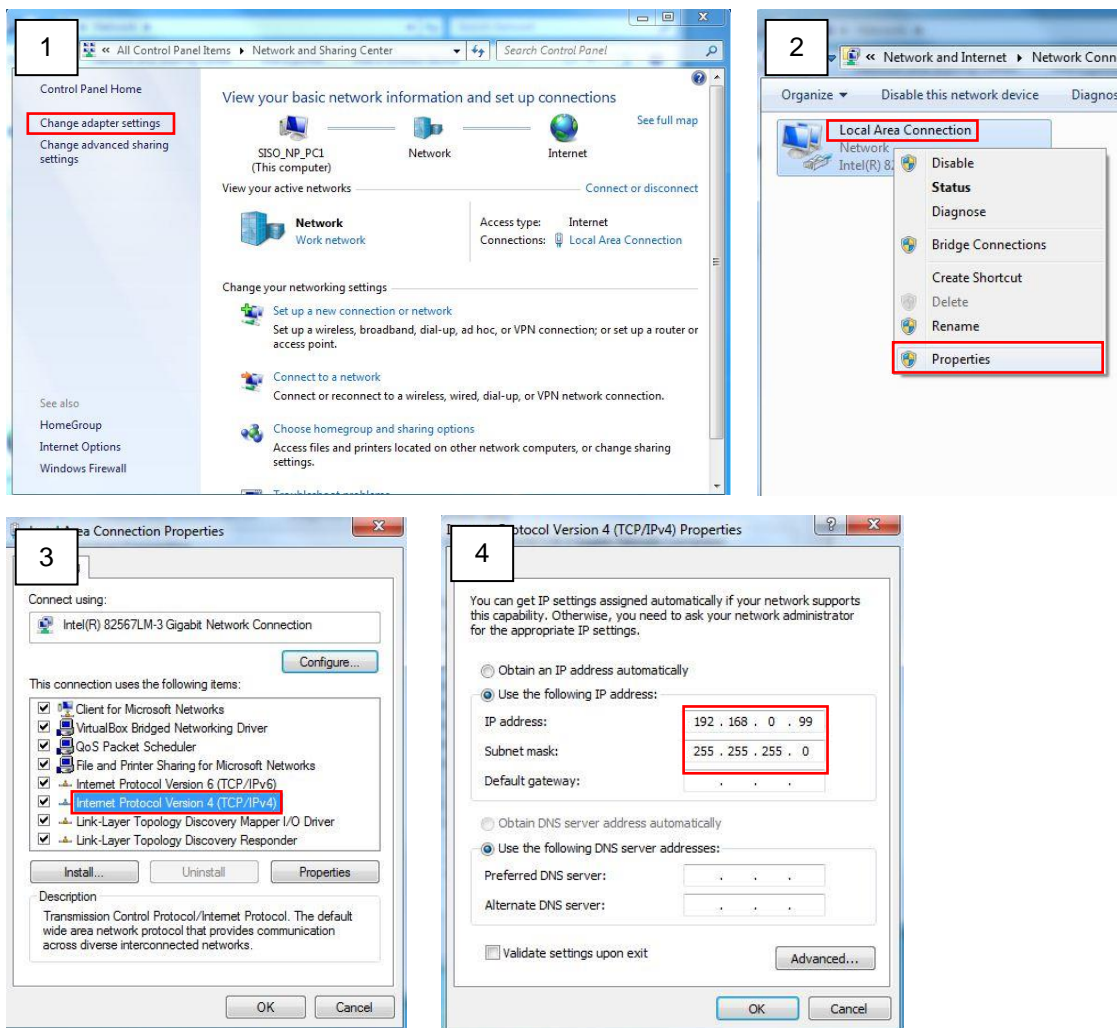

Manually adjust the IP addresses of multiple cameras:

If there are more than 1 camera to be used in the same local area network and there is no DHCP server to assign unique IP addresses to each of them, all of the cameras would then have the initial IP address of **192.168.0.100**, which is not a proper situation for network devices – all the IP addresses have to be different from each other. The easiest way to assign cameras the IP addresses is by using **IP Utility**:

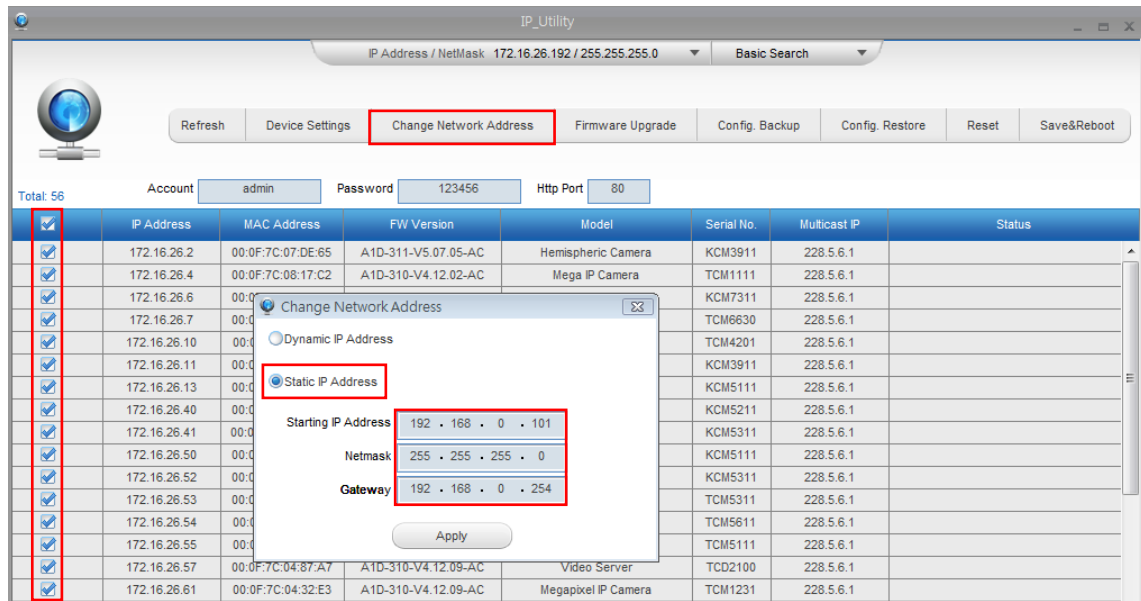

With the procedure shown above, all the cameras will have unique IP addresses, starting from 192.168.0.101. In case there are 20 cameras selected, the last one of the cameras would have the IP 192.168.0.120.

Later, by pressing the “Refresh” button of the IP Utility, you will be able to see the list of cameras with their new IP addresses.

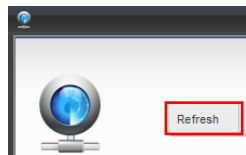

Please note that it is also possible to change the IP addresses manually by using the Web browser. In such case, please plug in only one camera at a time, and change its IP address by using the Web browser before plugging in the next one. This way, the Web browser will not be confused about two devices having the same IP address at the same time.

Access the Camera

Now that the camera and the PC are both having their unique IP addresses and are under the same network segment, it is possible to use the Web browser of the PC to access the camera.

You can use **Microsoft Internet Explorer** to access the camera.

Functionality	Internet Explorer
Live Video	Yes
Live Video Area Resizable	Yes
PTZ Control	Yes
Capture the snapshot	Yes
Video overlay based configuration (Motion Detection regions, Privacy Mask regions)	Yes
All the other configurations	Yes

When using Internet Explorer browser, the ActiveX control for video stream management will be downloaded from the camera directly – the user just has to accept the use of such control when prompted so. No other third party utilities are required to be installed in such case.

The following examples in this manual are based on Internet Explorer browser in order to cover all functions of the camera.

Assuming that the camera's IP address is **192.168.0.100**, you can access it by opening the Web browser and typing the following address into Web browser's address bar:

http://192.168.0.100

Upon successful connection to the camera, the user interface called **Web Configurator** would appear together with the login page. The HTTP port number was not added behind the IP address since the default HTTP port of the camera is 80, which can be omitted from the address for convenience.

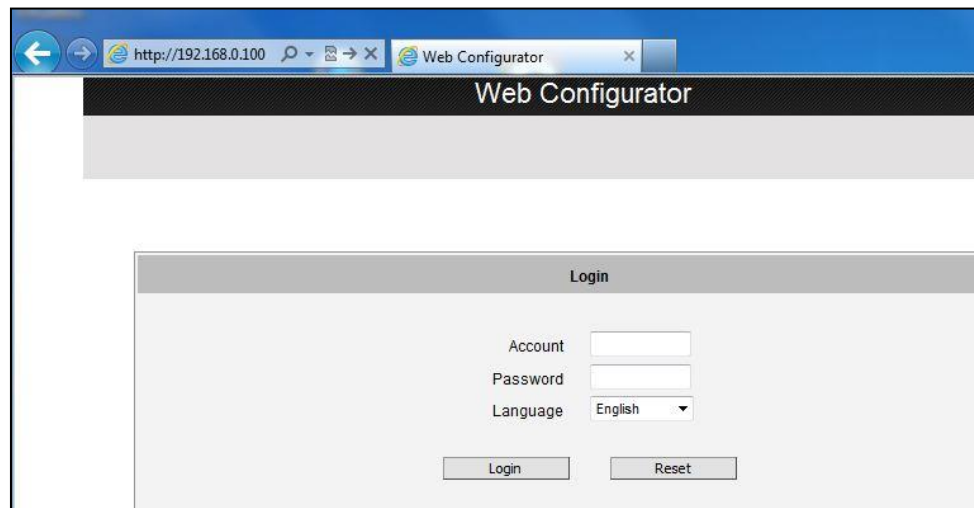

When you login, you will be asked to set a password. Follow the on-screen instructions to continue.



Copyright © 2019, ACTi Corporation All Rights Reserved

7F, No. 1, Alley 20, Lane 407, Sec. 2, Ti-Ding Blvd., Neihu District, Taipei, Taiwan 114, R.O.C.

TEL : +886-2-2656-2588 FAX : +886-2-2656-2599

Email: sales@acti.com